



PLC Connection Guide

EB Pro Ver.6.02.01

Table of content

ABB AC500.....	1	CODESYS V3 (Ethernet)	150
ABB EtherNet/IP (Implicit Messaging).....	6	Control Techniques SI-Ethernet Modbus TCP/IP	154
ABB NextMove ES	7	Control Technology 2500 Series	155
ABB TOTALFLOW FCU	10	Control Technology 2500 Series (Ethernet)	160
Altus ALNET-I.....	11	Copley Digital Drives	161
Arcus DMX-K-SA Series	17	CO-TRUST CTH300-H (Ethernet).....	166
Artrich Inverter AR100 Series.....	24	CO-TRUST CTH300-H PPI.....	168
Artrich Inverter AR200/216/600 Series.....	28	CROUZET M3 (FBD).....	175
BACnet/IP	35	CROUZET M3 (LAD)	179
BACnet/IP Server.....	47	Danfoss ECL Apex20	183
BACnet/MSTP.....	50	Danfoss ECL Apex20 (Ethernet).....	189
Barcode/Keyboard (USB/COM)	57	Danfoss FC Series.....	190
Baumuller	61	Danfoss VLT2800 Series	194
Beckhoff ADS (Absolute Addressing).....	64	DELTA AS300 MODBUS RTU/ASCII	198
Beckhoff ADS/AMS (Ethernet).....	67	DELTA AS300 MODBUS TCP/IP.....	202
Beckhoff Embedded PC.....	75	DELTA DVP.....	204
Beckhoff TwinCAT 3 ADS/AMS (Ethernet).....	86	DELTA DVPEN01-SL (Ethernet).....	210
Beckhoff TwinCAT PLC (Ethernet) – Free Tag Names	88	DELTA Ethernet/IP (AS Series)	213
Bosch Rexroth.....	92	DL-BCM Server	215
Bosch Rexroth IndraControl - Free Tag Names (Ethernet).....	98	DL/T645 CHUANG HONG.....	221
Bosch Rexroth SIS (Symbolic Addressing)	101	DL/T645 Standard.....	229
Brother Speedio (Ethernet)	105	DL/T645-2007 Standard	233
CAN Bus CANopen Slave.....	107	ELSIST MODBUS ASCII	237
CAN Bus 2.0A/2.0B General and SAE J1939	111	ELSIST MODBUS RTU	243
CAS CI-1580A	115	ELSIST MODBUS TCP/IP	249
CD MODBUS RTU	121	EMERSON Charge Module	250
CD MODBUS TCP/IP	127	EMERSON ControlWave (Ethernet) – Free Tag Names	253
Change.....	129	EMERSON PLC EC20	257
Cimon CM1-CP4A/ECO1A	132	EMERSON ROC800 Series - Free Tag Names.....	260
Cimon CM1-SC02A	135	Emotiontek MCU Controller.....	265
Cimon CM3-SP32MDT/SP16MDR/V/E/F(Ethernet)	138	Epson Robot Controller	270
Cimon PLC Series (Ethernet)	140	Fanuc 0i/30i/31i/32i/35i Series	282
CODESYS V2 (Absolute Addressing) (Ethernet)..	142	Fanuc 0i/30i/31i/32i/35i Series (Ethernet).....	286
CODESYS V2 (Symbolic Addressing)	143	FATEK FB/FBs/B1/B1z Series	289
CODESYS V2 (Symbolic Addressing) (Ethernet)..	147	Fuji NB Series	301
		Fuji SPH2000 (Ethernet)	304
		GE 90-30 Series (Ethernet)	306

GE CMM	308	KEYENCE	
GE RX3i.....	315	KV-L20V/700/1000/3000/5000/7500/Nano Series	
GE RX3i (Ethernet)	321	(Ethernet)	485
GE SNP-X	322	KEYENCE KV-L20V/700/1000/3000/5000/Nano	
GE VersaMax (Ethernet).....	331	Series (KV Studio Mode)	487
Haiwell PLC.....	333	KONNEX KNXnet/IP	497
Haiwell PLC (Ethernet).....	339	Korenix 6550.....	500
Hangzhou Maiou MO-TECH.....	341	KOYO CLICK.....	501
Hanyoung Controller	344	KOYO CLICK (Ethernet)	504
HAWE PLVC	348	KOYO DIRECT	506
HeFei ShenNong Motor	351	KOYO Do-more.....	528
Heng Yuan EU series	354	KOYO Do-more (Ethernet)	532
Hitachi EH-SIO	358	KOYO Ethernet.....	534
Hitachi EHV Series (Ethernet).....	366	KOYO NK1.....	536
Hitachi H/EH/EHV Series	367	KW ProConOS	540
HollySys LE/LM PLC	379	Lenze.....	543
HUST H4C.....	383	LingYan BMS	547
HUST H4X.....	386	LIYAN EX series	550
IAI PCON-C-42PI.....	389	LoXin.....	553
IAI X-SEL CONTROLLER.....	396	LS GLOFA Cnet.....	557
IAI X-SEL CONTROLLER-SSE	400	LS GLOFA FEnet (Ethernet).....	564
IDEC Micro	404	LS GLOFA GM3467 (LOADER)	565
IDEC MicroSmart.....	413	LS MASTER-K Cnet	568
IDEC MicroSmart FC6A Series	422	LS MASTER-K CPU Direct.....	571
IEC 60870-5-104 IEC 104 Client.....	431	LS MASTER-K MODBUS RTU.....	574
IEC 60870-5-104 IEC 104 Server.....	433	LS MASTER-K10S1	577
Inovance H2U/H1U	437	LS XBM/XBC Cnet.....	580
Inovance H3U Series	441	LS XBM/XBC FEnet (Ethernet)	586
Inovance H3U Series (Ethernet)	445	LS XBM/XBC/XGK CPU DIRECT	588
Invt GD5000 Series (Ethernet).....	446	LS XEC Cnet	593
JTEKT Toyopuc CMP-Link (Ethernt)	447	LS XEC FEnet (Ethernet)	600
JTEKT Toyopuc PCK05	452	LS XEC/XGI CPU DIRECT	602
JTEKT Toyopuc PCK06	455	LS XGI Cnet	606
Justfi Controller	460	LS XGI Fenet (Ethernet)	612
Kernel sistemi DMX Series.....	463	LS XGK Cnet.....	614
KEYENCE KV-10/16/24/40/80/Visual KV Series .	466	LS XGK FEnet (Ethernet).....	619
KEYENCE KV-3000.....	471	LS Mecapion Metronix AnyPack.....	621
KEYENCE KV-L20V/700/1000/3000/5000/Nano		LTi Motion LustBus	624
Series	474	LTi Motion ServoOne (Ethernet).....	628

Master-Slave Server	629	MODBUS ASCII	805
MEGMEET MC Series.....	632	MODBUS ASCII Server	813
MEIKONG Metro Safe Server	635	MODBUS RTU	821
Memory Map	644	MODBUS RTU (0x/1x Range Adjustable)	831
MIKOM MX Series PLC.....	652	MODBUS RTU (Adjustable).....	844
Mitsubishi A1S/A2N.....	656	MODBUS Server (COM/Ethernet).....	855
Mitsubishi A2A/A2U/A2AS/A2USH.....	659	MODBUS TCP/IP	867
Mitsubishi A2US.....	662	MODBUS TCP/IP (0x/1x Range Adjustable)	869
Mitsubishi A3A/A3N/A1SH/A2SH	665	MODBUS TCP/IP 32Bit	874
Mitsubishi AJ71.....	668	Moeller XC-CPU101	875
Mitsubishi AJ71 (AnA/AnU CPU).....	675	motrona BY-340	878
Mitsubishi AJ71 (Format 4)	682	motrona CT-150	884
Mitsubishi Alpha2	689	motrona CT15012B	887
Mitsubishi F930GOT Server	692	motrona MC700.....	890
Mitsubishi FX0S/FX0N/FX1S/FX1N/FX2.....	696	MTConnect (Ethernet).....	893
Mitsubishi FX232/485BD.....	705	Nanjing CIGU Controller (for i-Series only)	895
Mitsubishi FX2N	714	Nanotec Stepper Motor	898
Mitsubishi FX2N-10GM/20GM	718	NMEA 0183.....	902
Mitsubishi FX3U (Ethernet).....	722	ODVA EtherNet/IP Explicit Messaging	905
Mitsubishi FX3U/FX3G	729	OMRON C/CQM1 Series	908
Mitsubishi FX5U	733	OMRON CJ/CS/CP.....	913
Mitsubishi FX5U - ASCII Mode (Ethernet).....	738	OMRON CJ/CS/CP (Ethernet - FINS/TCP).....	918
Mitsubishi FX5U - Binary Mode (Ethernet)	742	OMRON CP Series (USB)	920
Mitsubishi L6ADP.....	746	OMRON E5CN/E5EZ/E5ZN	921
Mitsubishi MELSEC-Q/L - ASCII Mode (Ethernet)		OMRON Ethernet	926
.....	749	OMRON Ethernet (FINS/TCP)	930
Mitsubishi MELSEC-Q/L - Binary Mode (Ethernet)		OMRON EtherNet/IP (NJ/NX Series)	932
.....	753	OMRON Host Link.....	937
Mitsubishi MR J3/J4 A	757	OPC UA Client	942
Mitsubishi MR-MQ100 (Ethernet)	766	OPTO22 CONT Protocol (Ethernet)	945
Mitsubishi Q00/Q00UJ/Q01/QJ71	768	OPTO22 MMIO Protocol (Ethernet)	948
Mitsubishi Q00J	779	OuHua OHJX	952
Mitsubishi Q00U/Q01U/Q02U/QnUD/QnUDH	782	Panasonic Eco-Power Meters	955
Mitsubishi Q00UJ/QnU/QnUD/QnUDH/QnUDEH/L		Panasonic FP/KW	961
(mini USB)	786	Panasonic FP (Ethernet)	972
Mitsubishi Q02/02H	788	Panasonic FP2 (Ethernet)	974
Mitsubishi Q06H	792	Panasonic MEWTOCOL7	976
Mitsubishi QJ71E71 (Ethernet)	796	Panasonic MINAS A4	982
Mitsubishi R04 (Ethernet)	803	Panasonic MINAS A5	987

Parker ACR9000	994	SEW Movilink	1161
Parker Compax3	997	SEW MOVITRAC LTE	1165
Parker Compumotor 6K Series	1005	SHIMADEN MR13/FP93	1170
Parker SLVD Series	1008	SHJ-A	1184
PATLITE VM/VMS Series	1011	SICK FLEXI SOFT	1187
Rockwell CompactLogix - Free Tag Names.....	1020	Siemens LOGO (Ethernet)	1190
Rockwell CompactLogix/FlexLogix.....	1028	Siemens S7-1200 (symbolic addressing) (Ethernet)	
Rockwell DF1.....	1033	1195
Rockwell DF1 (BCC).....	1038	Siemens S7-1200/S7-1500 (absolute addressing)	
Rockwell DH485	1043	(Ethernet)	1208
Rockwell EtherNet/IP (CompactLogix)	1051	Siemens S7-200	1216
Rockwell EtherNet/IP (CompactLogix) – Free Tag		Siemens S7-200 (Ethernet).....	1222
Names	1053	Siemens S7-200 (VD any address).....	1230
Rockwell EtherNet/IP (ControlLogix) – Free Tag		Siemens S7-200 PPI.....	1236
Names	1059	Siemens S7-200 SMART (Ethernet)	1245
Rockwell EtherNet/IP (DF1)	1065	Siemens S7-200 SMART PPI.....	1247
Rockwell Micro850 (Ethernet) - Free Tag Names		Siemens S7-300	1251
.....	1067	Siemens S7-300/S7-400 (ISO Ethernet)	1260
Rockwell Micro850 - Free Tag Names	1073	Siemens S7-300 MPI.....	1263
Rockwell PLC5	1081	Siemens S7-300/ET200S (Ethernet)	1274
RS Automation OEMAX Series.....	1085	Siemens S7-400 (Ethernet).....	1280
RS Automation X8 Series	1088	Siemens TI505.....	1287
SAIA PCD PGU Mode.....	1092	Siemens TI505 (Ethernet)	1294
SAIA PCD S-BUS Mode.....	1095	Siemens TI565.....	1295
SAIA S-BUS (Ethernet)	1106	SIGMATEK S-DIAS CPU (Ethernet)	1302
Samsung SPC-10	1108	SSTC SSD Series	1307
SCENE6 Controller	1112	TECHSOFT Intelligent Servo	1321
Schleicher XCS 20C	1114	TECO Inverter	1324
Schleicher XCX 300	1117	TECO TP02 Series	1328
Schneider IMS MOTION	1122	TECO TP03 Series/AP-360BT-A	1334
Schneider IMS SERVO	1125	TINHAO.....	1338
Schneider MODBUS RTU.....	1128	Toptek Topvert.....	1342
Schneider MODBUS TCP/IP	1132	TOSHIBA INVERTER VF	1347
Schneider PowerLogic Modbus RTU	1134	TOSHIBA T Series.....	1351
Schneider SoMachine M Series (Ethernet)	1143	TOSHIBA MACHINE Provisor TC200	1360
Schneider UniTelway	1145	Trio MODBUS RTU, TCP/IP	1363
Schneider Zelio	1150	Trio MODBUS RTU, TCP/IP (Mode 7)	1371
SERVO BLDC (400/750WD)	1154	VIGOR	1379
SEUNGIL AHU	1157	VIGOR VS Series	1384

VIPA 200, for ex. 214-2BT10 (Ethernet)	1390
VIPA 200/300 MPI	1391
VIPA 300S (Ethernet)	1400
VIPA 300S, for ex. 315-4NE12 (Ethernet).....	1407
Weintek Built-in CODESYS	1412
Weintek Remote IO (CANopen)	1416
Weintek Remote IO (MODBUS TCP/IP).....	1423
WIELAND SAMOS PRO.....	1426
XINJE XC Series.....	1429
XINJE XD Series.....	1432
YAMAHA ERCD	1436
YASKAWA CCMEP	1440
YASKAWA DX100/DX200/FS100/YRC1000 Robot Controller (Ethernet)	1443
YASKAWA MP Series - Extension (Ethernet)....	1446
YASKAWA MP Series - Memobus	1450
YASKAWA MP Series Memobus (Ethernet)	1460
YASKAWA MP Series SIO (Extension)	1462
YASKAWA MP2300Siec (Ethernet)	1468
YASKAWA MP3000 Series – Extension (Ethernet)	1477
YASKAWA Sigma-5	1479
YASKAWA SMC 3010	1482
YASKAWA SMC 3010 (Ethernet)	1486
YOKOGAWA FA-M3	1489
YOKOGAWA FA-M3 (Ethernet).....	1496
YUDIAN AIBUS.....	1498

ABB AC500

Supported Series: ABB AC500

HMI Setting:

Parameters	Recommended	Options	Notes
PLC type	ABB AC500		
PLC I/F	RS485 2W	RS232/RS485 2W / Ethernet	
Baud rate	19200		
Data bits	8		
Parity	Even		
Stop bits	1		
PLC sta. no.	0		
Port no.	502		Ethernet

Device Address:

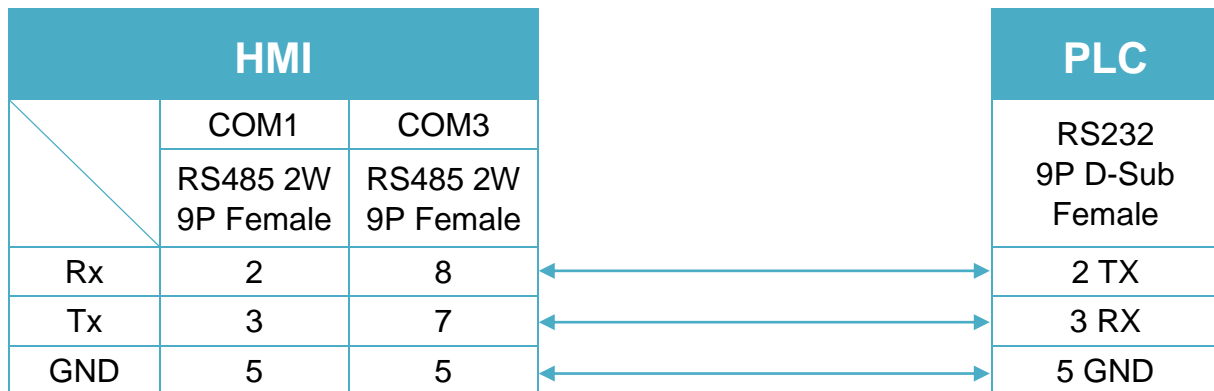
Bit/Word	Device type	Format	Range	Memo
B	MX0	DDDDo	0 ~ 81917	%MX0.0.0 ~ 0.8191.7
W	MW0	DDDDD	0 ~ 32767	%MW0.0 ~ 0.32767
W	MW1	DDDDD	0 ~ 32767	%MW0.1 ~ 1.32767
DW	MD0	DDDDD	0 ~ 16383	
DW	MD1	DDDDD	0 ~ 16383	

Wiring Diagram:

RS-232 9P D-Sub (Diagram 1 ~ Diagram 3)

Diagram 1

cMT Series	<i>cMT3151</i>
eMT Series	<i>eMT3070 / eMT3105 / eMT3120 / eMT3150</i>
MT-iE	<i>MT8073iE / MT8102iE</i>
MT-XE	<i>MT8092XE</i>
MT-iP	<i>MT6103iP</i>


Diagram 2

cMT Series	cMT-SVR
mTV	mTV
MT-iE	MT8070iE / MT6070iE / MT8100iE / MT8121iE / MT8150iE / MT8071iE / MT6071iE / MT8072iE / MT6072iE / MT8073iE / MT8101iE / MT8102iE / MT8103iE
MT-XE	MT8121XE / MT8150XE / MT8090XE


Diagram 3

MT-iE	MT8050iE
MT-iP	MT6051iP / MT6071iP / MT8071iP



RS-485 2W 9P D-Sub (Diagram 4 ~ Diagram 9)

Diagram 4

cMT Series *cMT3151*

eMT Series *eMT3070 / eMT3105 / eMT3120 / eMT3150*

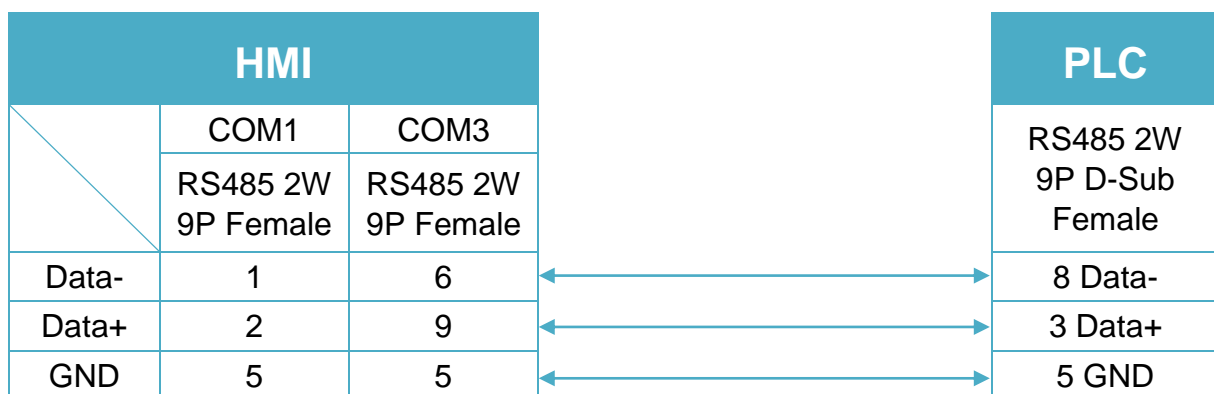


Diagram 5

cMT Series *cMT-SVR*

mTV *mTV*

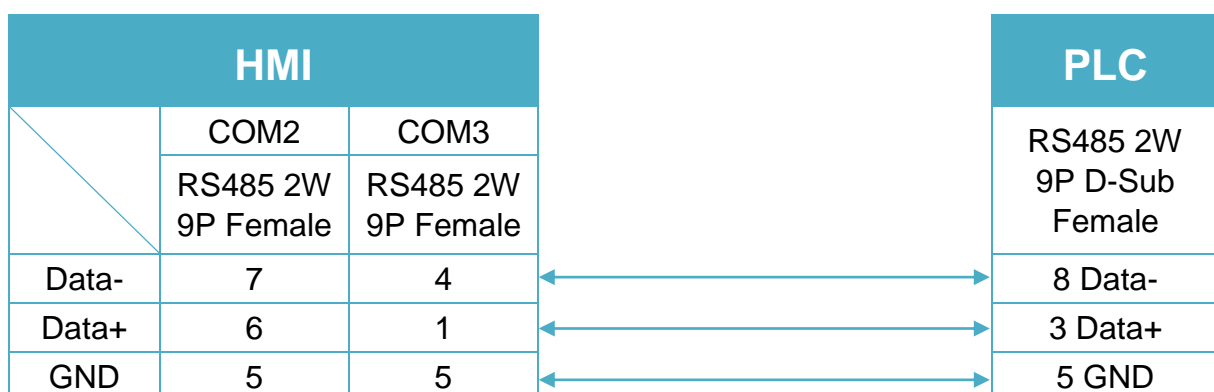


Diagram 6

MT-iE *MT8070iE / MT6070iE / MT8100iE / MT8121iE / MT8150iE*

MT-XE *MT8121XE / MT8150XE*

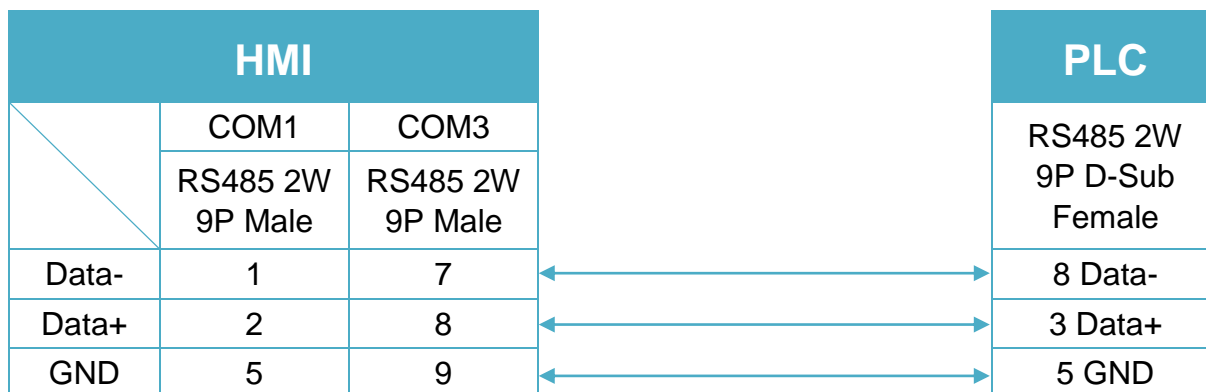


Diagram 7

MT-iE *MT8071iE / MT6071iE / MT8072iE / MT6072iE / MT8073iE /
MT8101iE / MT8102iE / MT8103iE*

MT-XE *MT8090XE / MT8092XE*

MT-iP *MT6103iP*

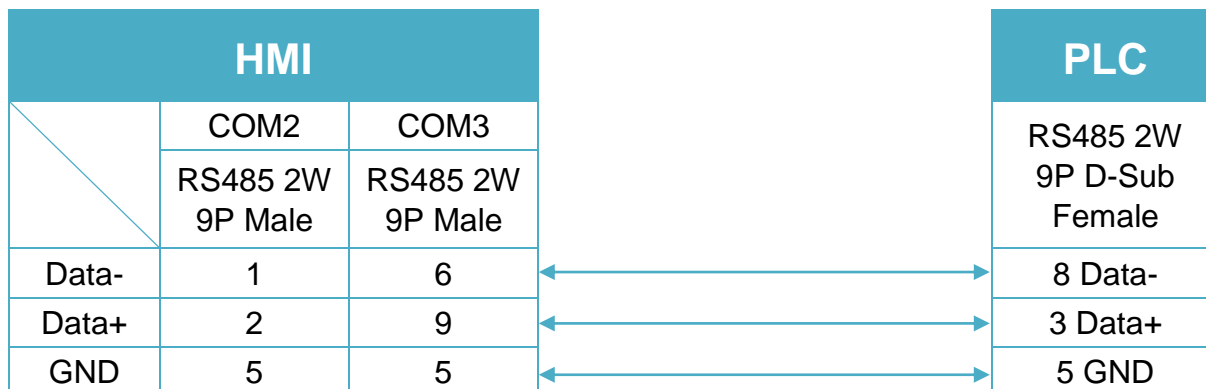


Diagram 8

MT-iE *MT8050iE*

MT-iP *MT6051iP*

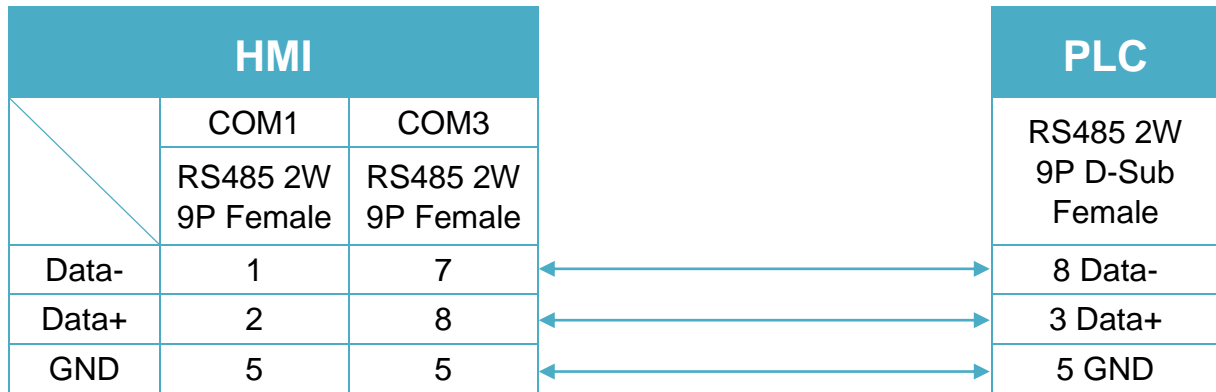


Diagram 9

MT-iP
MT6071iP / MT8071iP


Diagram 10

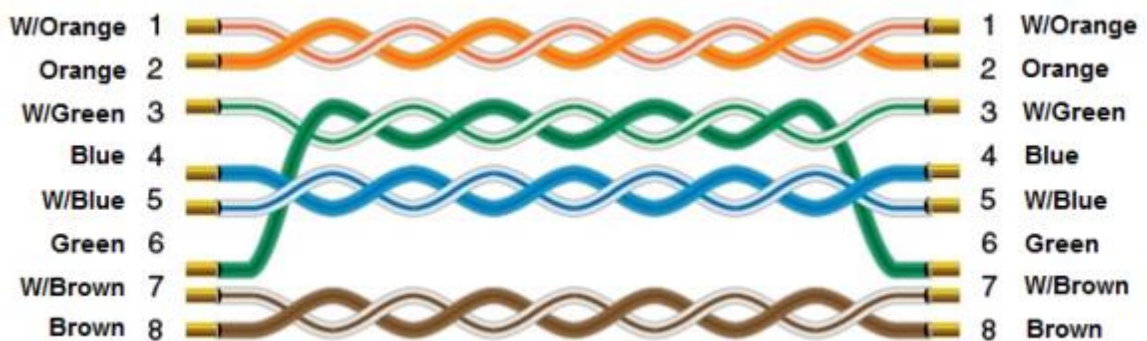
Ethernet cable:


ABB EtherNet/IP (Implicit Messaging)

Supported Series: ABB EtherNet/IP (Implicit Messaging)

HMI Setting:

Parameters	Recommended	Options	Notes
PLC type	ABB EtherNet/IP (Implicit Messaging)		
PLC I/F	Ethernet		
Port no.	44818		
Assembly instance	Input::101 Output:111	Input::101~106 Output:111~116	
Mode	Anybus Adapter (IRC5-DSQC669)	Anybus Adapter (IRC5-DSQC669) EIP Adapter (IRC5-DSQC10XX)	

Online simulator	YES
-------------------------	-----

Device Address:

Bit/Word	Device type	Format	Range	Memo
B	Input_Bit	DDDdd	0 ~ 51215	
B	Output_Bit	DDDdd	0 ~ 51215	
B	Input	DDD	0 ~ 512	
B	Output	DDD	0 ~ 512	

Wiring Diagram:

Ethernet cable



ABB NextMove ES

Supported Series: ABB NextMove ES

HMI Setting:

Parameters	Recommended	Options	Notes
PLC type	ABB NextMove ES		
PLC I/F	RS232		
Baud rate	9600	9600~115200	
Data bits	8		
Parity	None		
Stop bits	1		
PLC sta. no.	2	0~127	

Device Address:

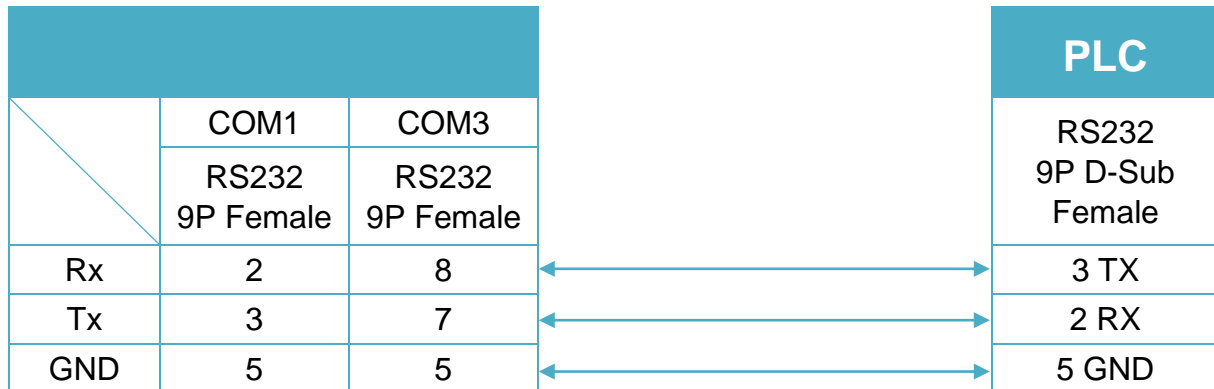
Bit/Word	Device type	Format	Range	Memo
DW	COMMS_Int_Bit	DDDdd	100 ~ 25531	
DW	COMMS	DDD	1 ~ 255	Float
DW	COMMS_Int	DDD	1 ~ 255	Int

Wiring Diagram:

RS-232 9P D-Sub (Diagram 1 ~ Diagram 3)

Diagram 1

cMT Series	<i>cMT3151</i>
eMT Series	<i>eMT3070 / eMT3105 / eMT3120 / eMT3150</i>
MT-iE	<i>MT8073iE / MT8102iE</i>
MT-XE	<i>MT8092XE</i>
MT-iP	<i>MT6103iP</i>


Diagram 2

cMT Series	<i>cMT-SVR</i>
mTV	<i>mTV</i>
MT-iE	<i>MT8070iE / MT6070iE / MT8100iE / MT8121iE / MT8150iE / MT8071iE / MT6071iE / MT8072iE / MT6072iE / MT8073iE / MT8101iE / MT8102iE / MT8103iE</i>
MT-XE	<i>MT8121XE / MT8150XE / MT8090XE</i>

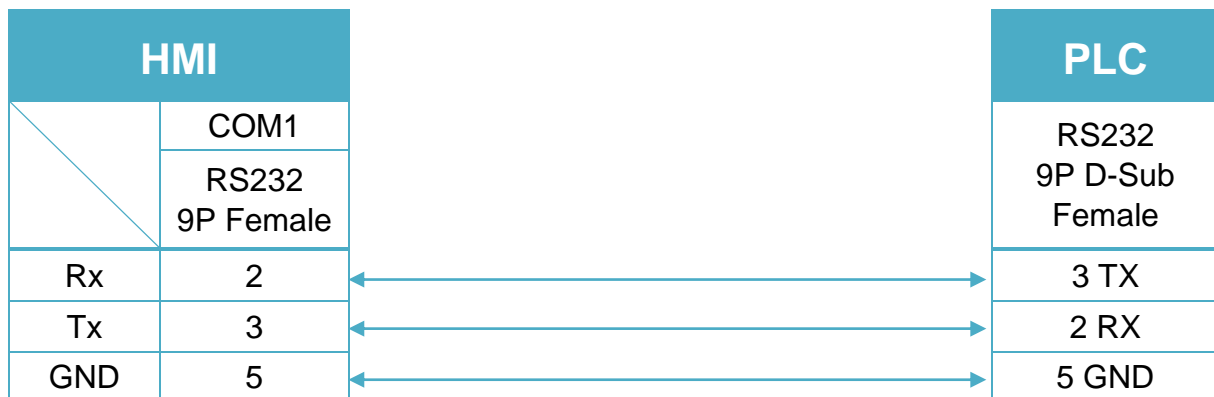


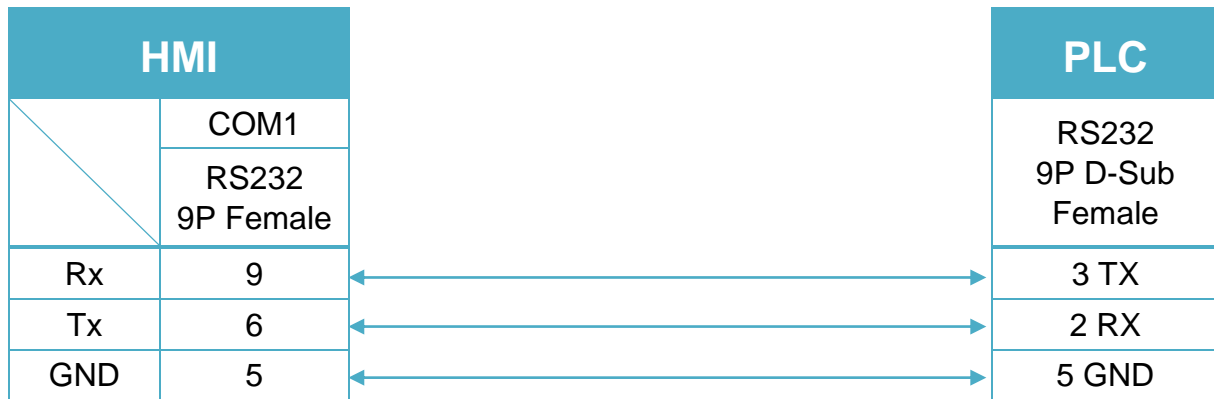
Diagram 3
MT-iE
MT8050iE
MT-iP
MT6051iP / MT6071iP / MT8071iP


ABB TOTALFLOW FCU

Supported Series: ABB TOTALFLOW FCU

Website: <http://new.abb.com/us>

HMI Setting:

Parameters	Recommended	Options	Notes
PLC type	ABB TOTALFLOW FCU		
PLC I/F	Ethernet		
Port no.	10000		
PLC sta. no.	0		

Device Address:

Bit/Word	Device type	Format	Range	Memo
B	BIT	DDD.DDD.DDDD	0 ~ 255.748.3647	
B	W_BIT	DDD.DDD.DDDDdd	0 ~ 255.748.364715	
Byte	BYTE	DDD.DDD.DDDD	0 ~ 255.748.3647	
W	WORD	DDD.DDD.DDDD	0 ~ 255.748.3647	
DW	DWORD	DDD.DDD.DDDD	0 ~ 255.748.3647	
W	STRING	DDD.DDD.DDDD	0 ~ 255.748.3647	

Wiring Diagram:

Diagram 1

Ethernet cable:



Altus ALNET-I

Supported Series: Altus SeriesMode PO3042, PO3142, PO3242, PO3342, PL103, PL104, PL105, QK800, QK801, QK2000.

HMI Setting:

Parameters	Recommended	Options	Notes
PLC type	Altus ALNET-I		
PLC I/F	RS232		
Baud rate	9600		
Data bits	8		
Parity	Even		
Stop bits	1		
PLC sta. no.	0		

Device Address:

Bit/Word	Device Type	Format	Range	Memo
B	M_Bit	DDDDh	0 ~ 1023f	Memories
B	A	DDDh	0 ~ 511f	Auxiliary Relays
B	E	DDDh	0 ~ 511f	Input Relays
B	D_Bit	DDDDdd	0 ~ 102331	Decimals
B	F_Bit	DDDDdd	0 ~ 102331	Reals
B	I_Bit	DDDDdd	0 ~ 102331	Integers
B	S	DDDh	0 ~ 511f	Output Relays
W	M	DDDD	0 ~ 4096	Memories
DW	D	DDDD	0 ~ 4096	Decimals
DW	F	DDDD	0 ~ 1023	Reals
DW	I	DDDD	0 ~ 1023	Integers
W	TM	HHHH	0 ~ ffff*	Memory Tables
DW	TD	HHHH	0 ~ ffff*	Decimal Tables
DW	TF	HHHH	0 ~ ffff*	Real Tables
DW	TI	HHHH	0 ~ ffff*	Integer Tables

Note: The formats of TM, TD, TF and TI in PLC software are represented as TXA[B]. "X" can be M, D, F, or I. The address range of B is 0~FF, and A is 0~FF. The device type is AAB, and the range depends on the PLC settings.

For example: Model PO3242, range of "A" is "0" and range of "B" is 0 ~ 7.

Wiring Diagram:

PLC PO3042, PO3142, PO3242, PO3342: RS-232 8P RJ45 (Diagram 1 ~ Diagram 3)

Diagram 1

cMT Series	<i>cMT3151</i>
eMT Series	<i>eMT3070 / eMT3105 / eMT3120 / eMT3150</i>
MT-iE	<i>MT8073iE / MT8102iE</i>
MT-XE	<i>MT8092XE</i>
MT-iP	<i>MT6103iP</i>

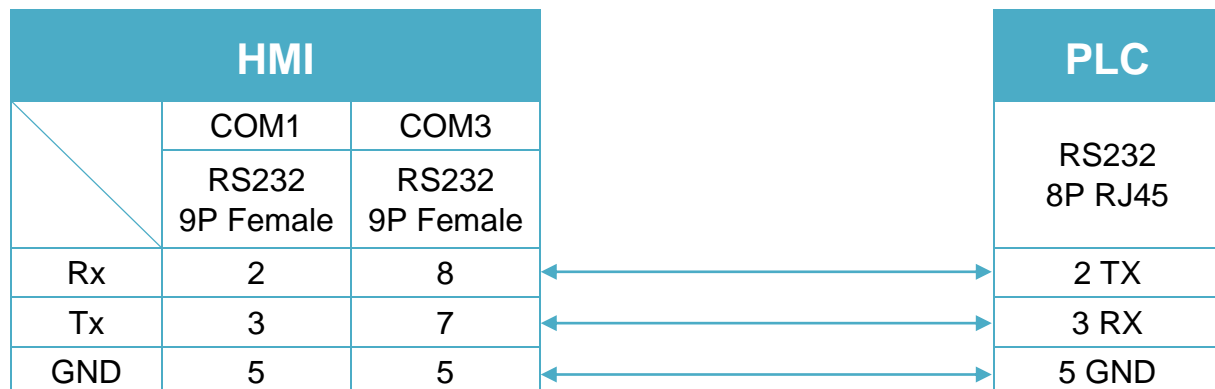


Diagram 2

cMT Series	<i>cMT-SVR</i>
mTV	<i>mTV</i>
MT-iE	<i>MT8070iE / MT6070iE / MT8100iE / MT8121iE / MT8150iE / MT8071iE / MT6071iE / MT8072iE / MT6072iE / MT8073iE / MT8101iE / MT8102iE / MT8103iE</i>
MT-XE	<i>MT8121XE / MT8150XE / MT8090XE</i>

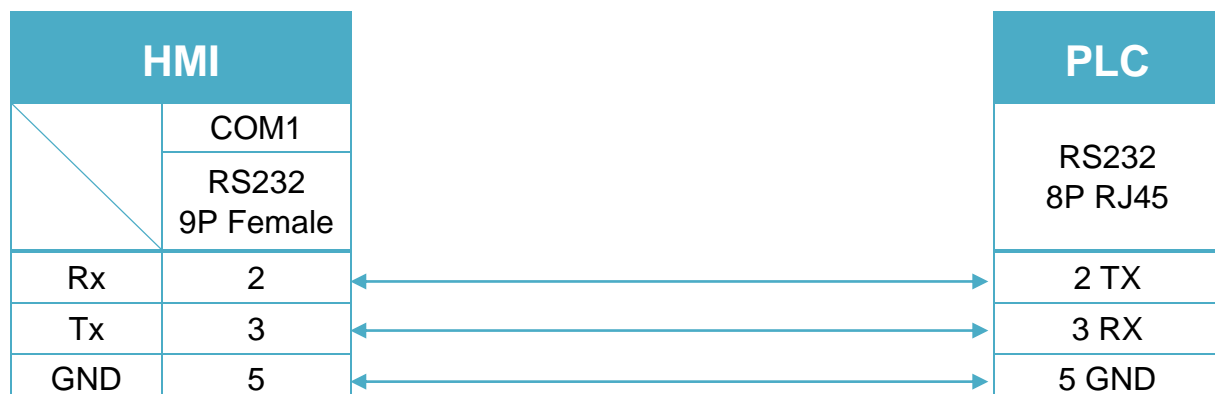


Diagram 3

MT-iE	<i>MT8050iE</i>
MT-iP	<i>MT6051iP / MT6071iP / MT8071iP</i>



PLC PL103, PL104, PL105: RS-232 9P D-Sub (Diagram 4 ~ Diagram 6)

Diagram 4

cMT Series	<i>cMT3151</i>
eMT Series	<i>eMT3070 / eMT3105 / eMT3120 / eMT3150</i>
MT-iE	<i>MT8073iE / MT8102iE</i>
MT-XE	<i>MT8092XE</i>
MT-iP	<i>MT6103iP</i>

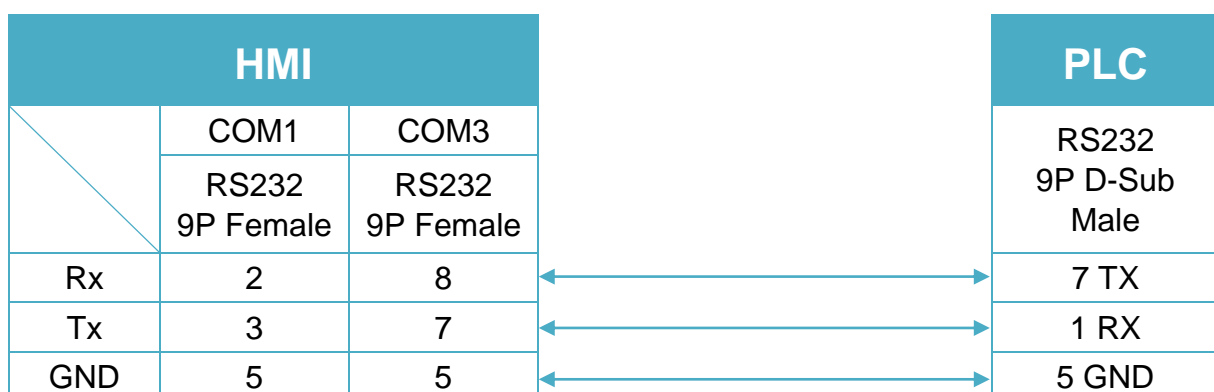


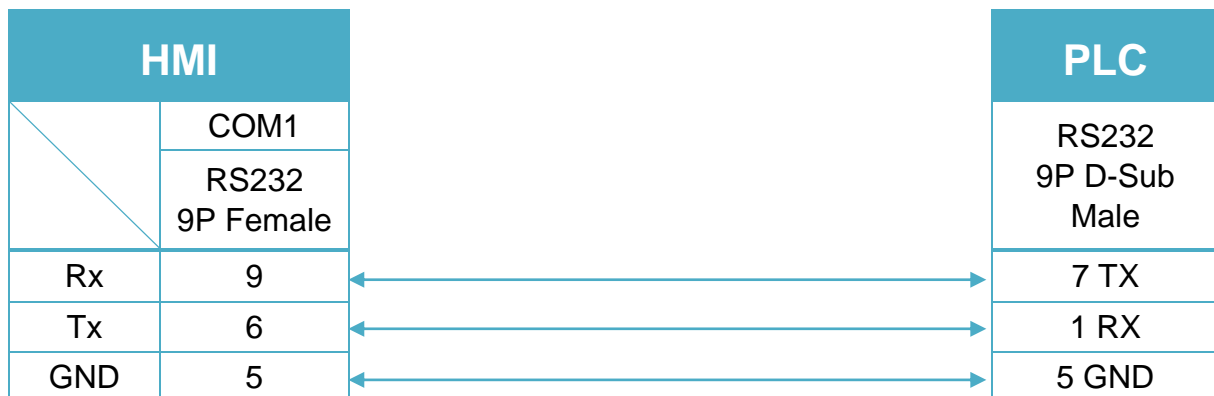
Diagram 5

cMT Series	cMT-SVR
mTV	mTV
MT-iE	MT8070iE / MT6070iE / MT8100iE / MT8121iE / MT8150iE / MT8071iE / MT6071iE / MT8072iE / MT6072iE / MT8073iE / MT8101iE / MT8102iE / MT8103iE
MT-XE	MT8121XE / MT8150XE / MT8090XE



Diagram 6

MT-iE	MT8050iE
MT-iP	MT6051iP / MT6071iP / MT8071iP



PLC QK800, QK801, QK2000: RS-232 9P D-Sub (Diagram 7 ~ Diagram 9)

Diagram 7

cMT Series	<i>cMT3151</i>
eMT Series	<i>eMT3070 / eMT3105 / eMT3120 / eMT3150</i>
MT-iE	<i>MT8073iE / MT8102iE</i>
MT-XE	<i>MT8092XE</i>
MT-iP	<i>MT6103iP</i>

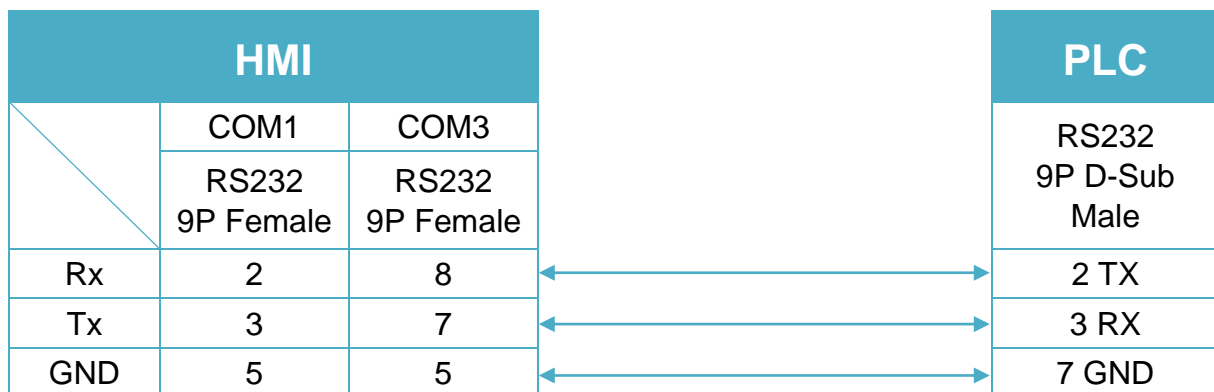


Diagram 8

cMT Series	<i>cMT-SVR</i>
mTV	<i>mTV</i>
MT-iE	<i>MT8070iE / MT6070iE / MT8100iE / MT8121iE / MT8150iE / MT8071iE / MT6071iE / MT8072iE / MT6072iE / MT8073iE / MT8101iE / MT8102iE / MT8103iE</i>
MT-XE	<i>MT8121XE / MT8150XE / MT8090XE</i>

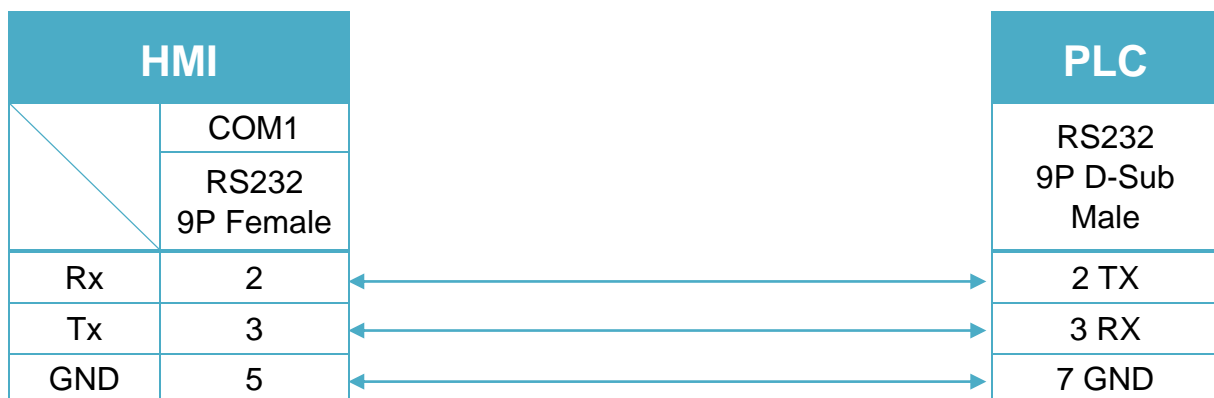
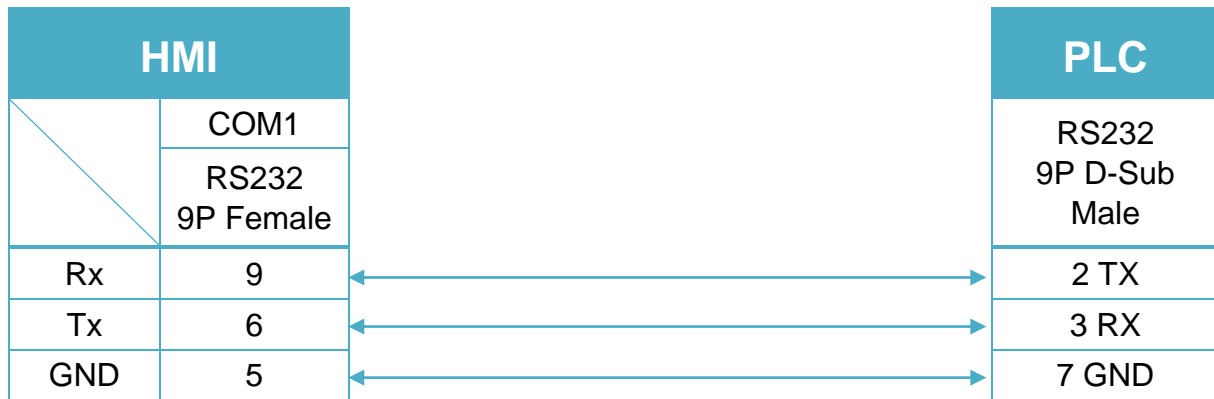


Diagram 9

MT-iE
MT8050iE
MT-iP
MT6051iP / MT6071iP / MT8071iP


Arcus DMX-K-SA Series

Supported Series: Arcus DMX-K-SA Series.

Website: <http://www.arcus-technology.com/>

HMI Setting:

Parameters	Recommended	Options	Notes
PLC type	Arcus DMX-K-SA Series		
PLC I/F	RS232	RS232 / RS485 2W	
Baud rate	9600	9600 ~ 115200	
Data bits	8		
Parity	None		
Stop bits	1		
PLC sta. no.	1		

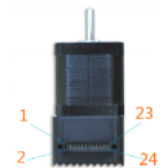
Device Address:

Bit/Word	Device Type	Format	Range	Memo
B	ABORT	D	0	
B	ABS	D	0	
B	CLR	D	0	
B	CLRS	D	0	
B	DI_Bit	D	1 ~ 6	
B	DO_Bit	D	1 ~ 3	
B	EDO	D	0	
B	EO	D	0	
B	H+	D	0	
B	H-	D	0	
B	J+	D	0	
B	J-	D	0	
B	L+	D	0	
B	L-	D	0	
B	LT	D	0	
B	MM	D	0	
B	MST	D	0 ~ 9	
B	POL	D	0 ~ 8	
B	RT	D	0	

Bit/Word	Device Type	Format	Range	Memo
B	SCV	D	0	
B	SL	D	0	
B	STORE	D	0	
B	SLOAD	D	0	
B	STOP	D	0	
B	Z+	D	0	
B	Z-	D	0	
B	ZH+	D	0	
B	ZH-	D	0	
W	ACC	D	0	
W	CUR	D	0	
W	CURI	D	0	
W	CURR	D	0	
W	DB	D	0	
W	DI	D	0	
W	DN	D	0 ~ 2	
W	DO	D	0	
W	DX	D	0	
W	EX	D	0	
W	HSPD	D	0	
W	ID	D	0 ~ 6	
W	LCA	D	0	
W	LSPD	D	0	
W	LTE	D	0	
W	LTP	D	0	
W	LTS	D	0	
W	PS	D	0	
W	PX	D	0	
W	SA	DDDD	0 ~ 1275	
W	SASTAT	D	0	
W	SLA	D	0	
W	SLE	D	0	
W	SLS	D	0	
W	SLT	D	0	
W	SR	D	0	
W	SPC	D	0	
W	SSPD	D	0	

Bit/Word	Device Type	Format	Range	Memo
W	SSPDM	D	0	
W	V	DD	0 ~ 99	
W	VER	D	0	
W	X	D	0	

Wiring Diagram:



RS-232 24P Connector (Diagram 1 ~ Diagram 3)

Diagram 1

cMT Series	<i>cMT3151</i>
eMT Series	<i>eMT3070 / eMT3105 / eMT3120 / eMT3150</i>
MT-iE	<i>MT8073iE / MT8102iE</i>
MT-XE	<i>MT8092XE</i>
MT-iP	<i>MT6103iP</i>

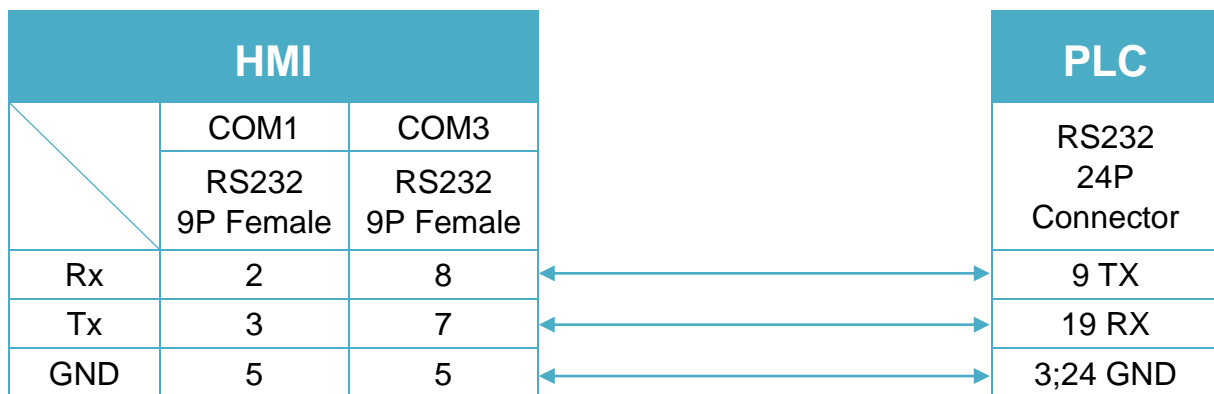


Diagram 2

cMT Series	cMT-SVR
mTV	mTV
MT-iE	MT8070iE / MT6070iE / MT8100iE / MT8121iE / MT8150iE / MT8071iE / MT6071iE / MT8072iE / MT6072iE / MT8073iE / MT8101iE / MT8102iE / MT8103iE
MT-XE	MT8121XE / MT8150XE / MT8090XE

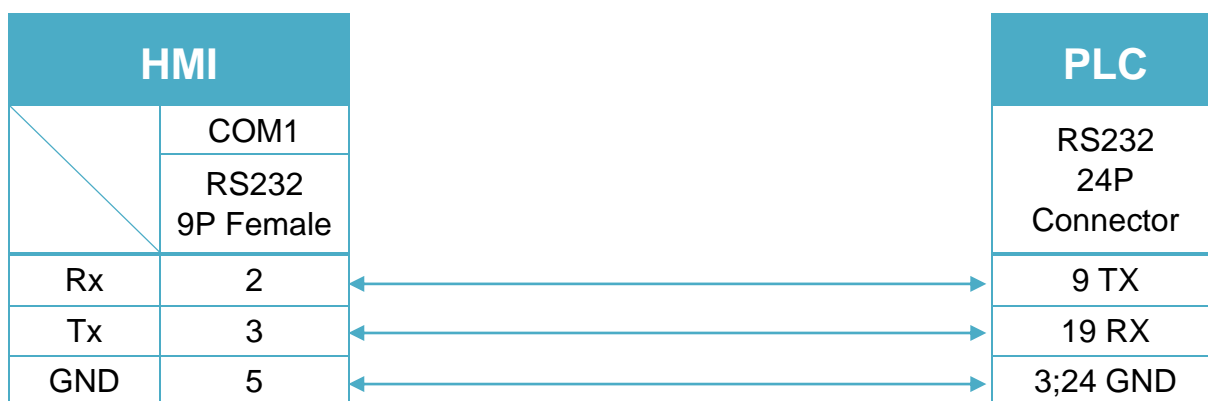
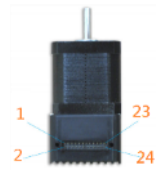


Diagram 3

MT-iE	MT8050iE
MT-iP	MT6051iP / MT6071iP / MT8071iP





RS-485 2W 24P Connector (Diagram 4 ~ Diagram 9)

Diagram 4

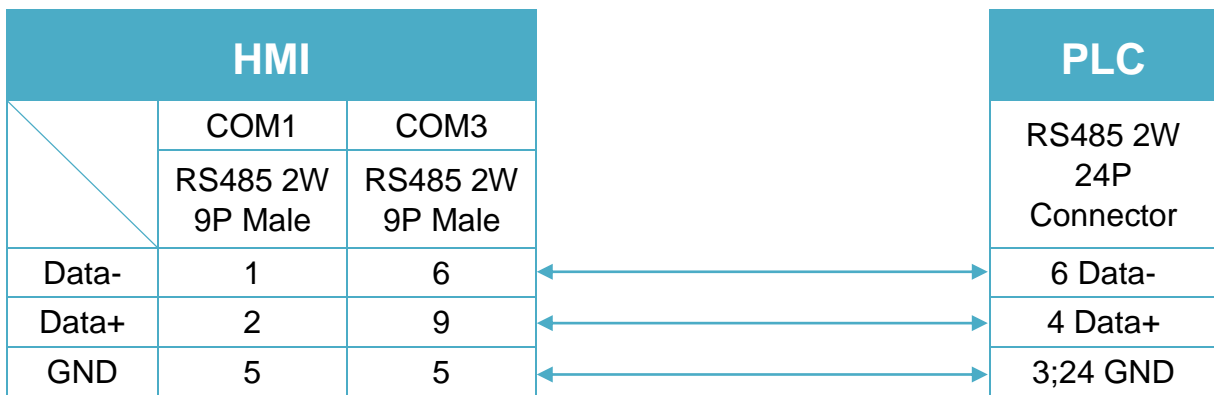
cMT Series
cMT3151
eMT Series
eMT3070 / eMT3105 / eMT3120 / eMT3150


Diagram 5

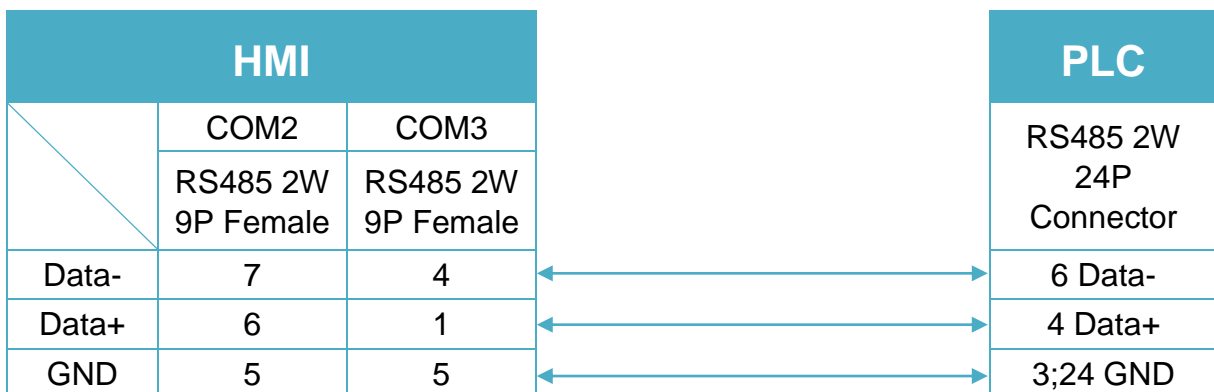
cMT Series
cMT-SVR
mTV
mTV


Diagram 6

MT-iE *MT8070iE / MT6070iE / MT8100iE / MT8121iE / MT8150iE*

MT-XE *MT8121XE / MT8150XE*

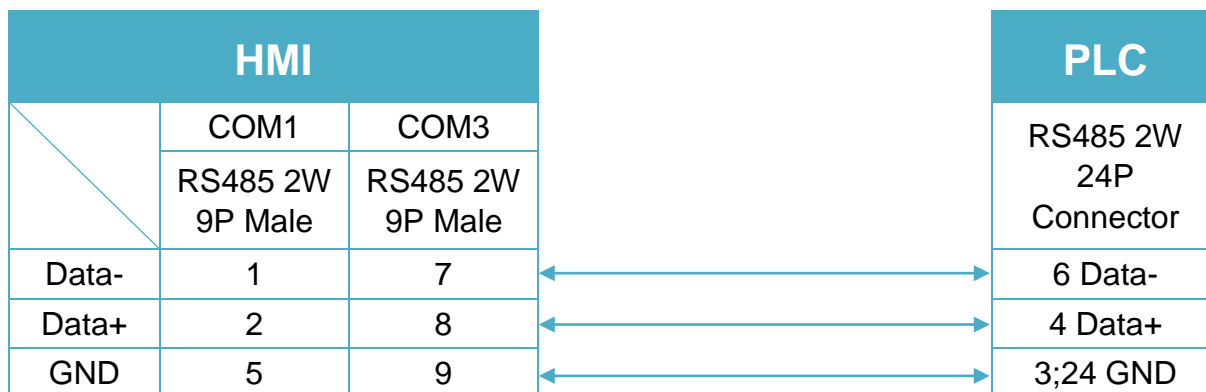


Diagram 7

MT-iE *MT8071iE / MT6071iE / MT8072iE / MT6072iE / MT8073iE /
MT8101iE / MT8102iE / MT8103iE*

MT-XE *MT8090XE / MT8092XE*

MT-iP *MT6103iP*

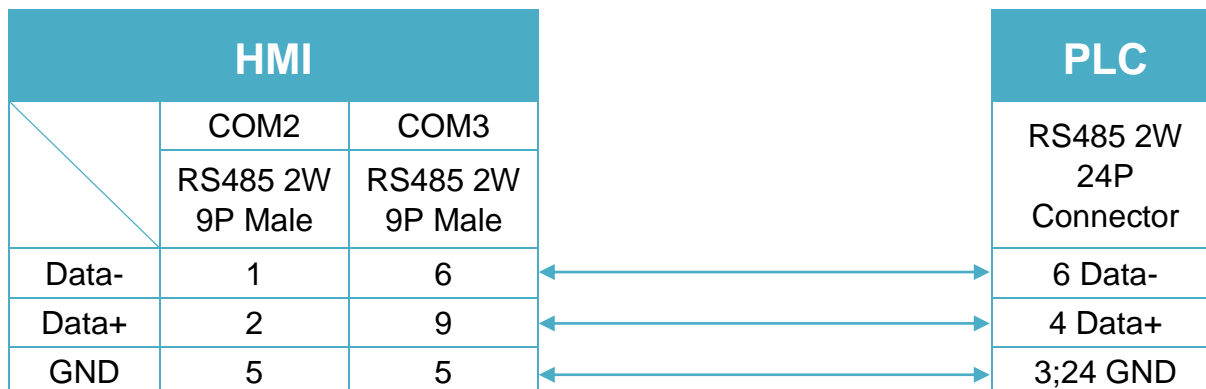


Diagram 8

MT-iE *MT8050iE*

MT-iP *MT6051iP*

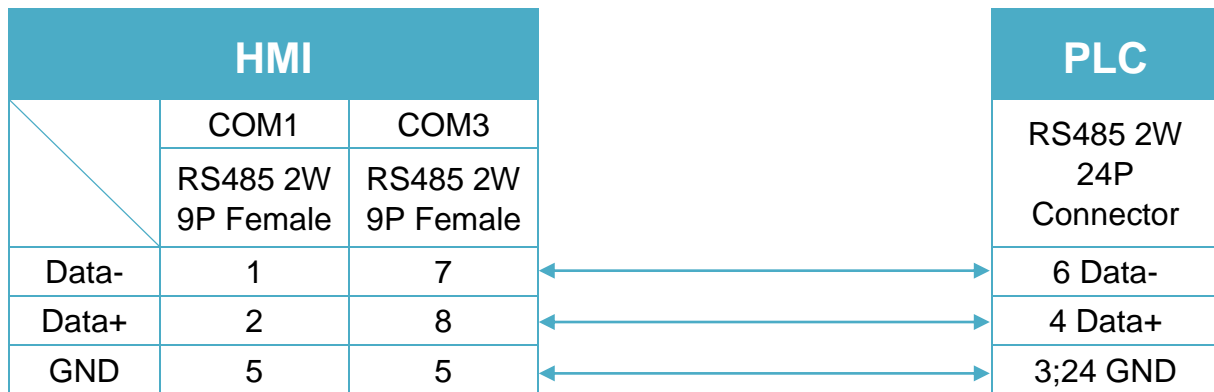
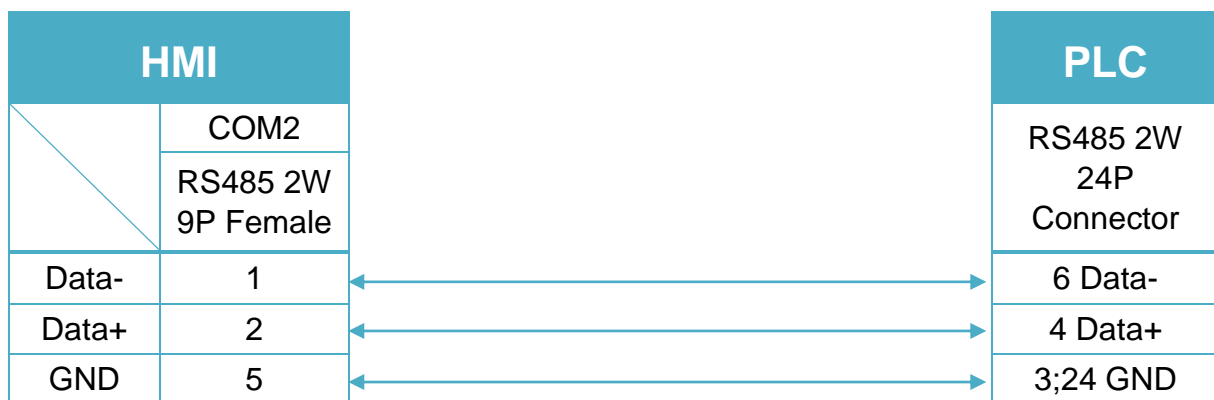


Diagram 9

MT-iP *MT6071iP / MT8071iP*



Artrich Inverter AR100 Series

Supported Series: Artrich Inverter AR100 Series

Website: www.artrich.cn

HMI Setting:

Parameters	Recommended	Options	Notes
PLC type	Artrich Inverter AR100 Series		
PLC I/F	RS485 2W		
Baud rate	9600		
Data bits	8		
Parity	None		
Stop bits	1		
PLC sta. no.	1		

Device Address:

Bit/Word	Device type	Format	Range	Memo
B	F3002_bit	Hh	0 ~ 0f	
B	F3003_bit	Hh	0 ~ 0f	
W	F0-0 ~ F0-1	D	0	W/R
W	F0-2	D	0 ~ 1	W/R *Note1
W	F0-3 ~ F0-157	D	0	W/R
W	F2-0 ~ F2-16	D	0	Read only
W	F3000 ~ F3001	D	0	Write only
W	F3002 ~ F3003	D	0	Read only
W	FC01 ~ FC12	D	0	Read only

Note 1: Value 0 means write to NAND Flash (Data will be saved after power off.) Value 1 means write to RAM (Data will not be saved after power off.)

Wiring Diagram:

RS-485 2W 8P RJ45 (Diagram 1 ~ Diagram 6)

Diagram 1

cMT Series ***cMT3151***

eMT Series ***eMT3070 / eMT3105 / eMT3120 / eMT3150***

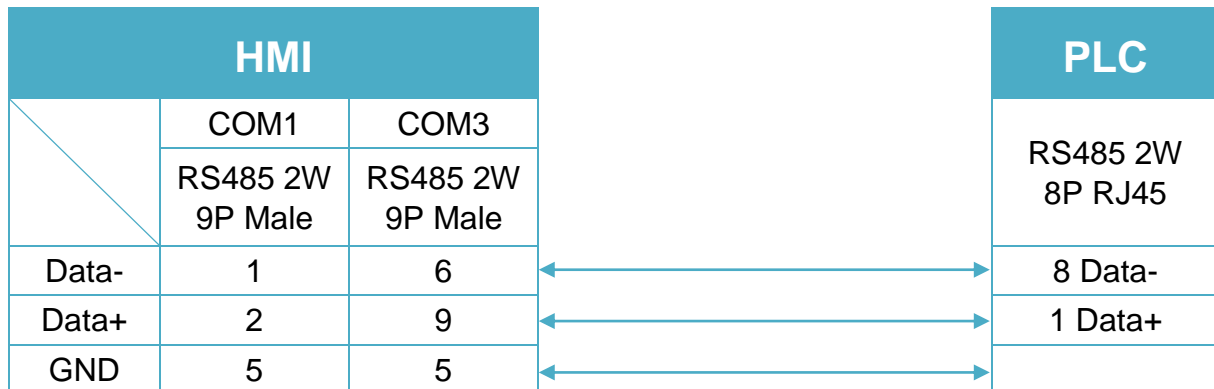


Diagram 2

cMT Series ***cMT-SVR***

mTV ***mTV***

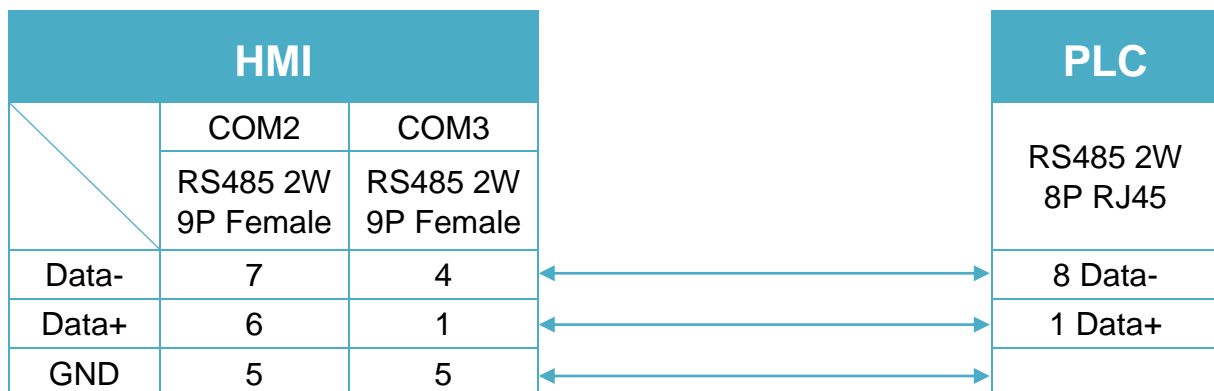


Diagram 3

MT-iE *MT8070iE / MT6070iE / MT8100iE / MT8121iE / MT8150iE*

MT-XE *MT8121XE / MT8150XE*

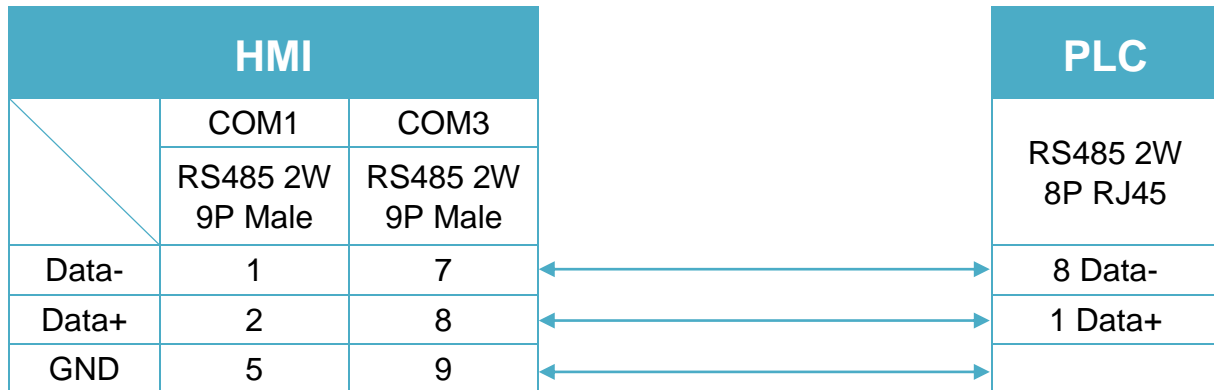


Diagram 4

MT-iE *MT8071iE / MT6071iE / MT8072iE / MT6072iE / MT8073iE /
MT8101iE / MT8102iE / MT8103iE*

MT-XE *MT8090XE / MT8092XE*

MT-iP *MT6103iP*

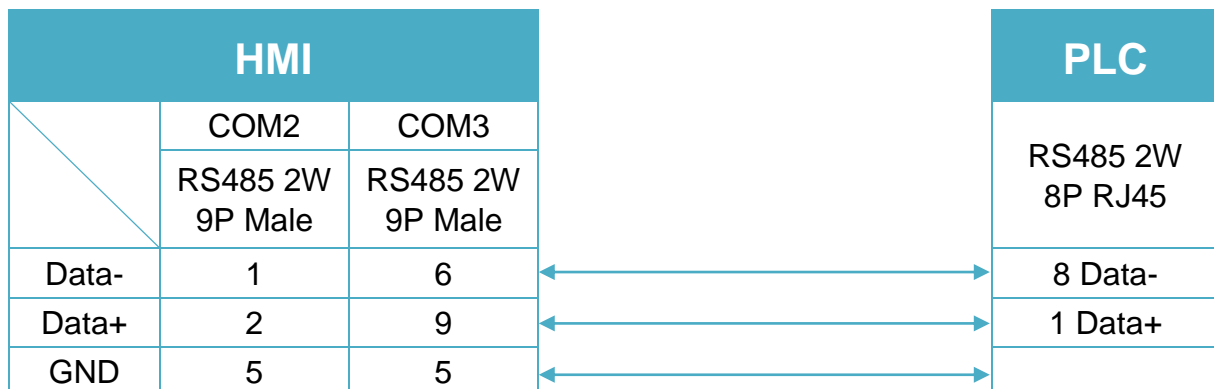


Diagram 5

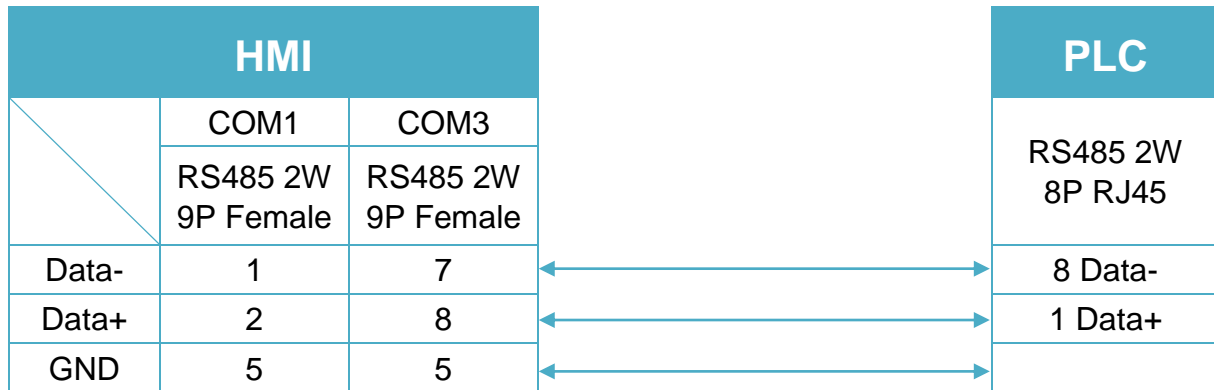
MT-iE *MT8050iE*
MT-iP *MT6051iP*


Diagram 6

MT-iP *MT6071iP / MT8071iP*


Artrich Inverter AR200/216/600 Series

Supported Series: Artrich Inverter AR200/216/600 Series

Website: www.artrich.cn

HMI Setting:

Parameters	Recommended	Options	Notes
PLC type	Artrich Inverter AR200/216/600 Series		
PLC I/F	RS485 2W		
Baud rate	9600		
Data bits	8		
Parity	None		
Stop bits	1		
PLC sta. no.	1		

Device Address:

Bit/Word	Device type	Format	Range	Memo
B	F3002_bit	Hh	0 ~ 0f	
B	F3003_bit	Hh	0 ~ 0f	
W	F0-0 ~ F0-1	D	0	W/R
W	F0-2	D	0 ~ 1	W/R *Note1
W	F0-3 ~ F0-178	D	0	W/R
W	F2-0 ~ F2-16	D	0	Read only
W	F3000 ~ F3001	D	0	Write only
W	F3002 ~ F3003	D	0	Read only
W	FC01 ~ FC12	D	0	Read only

Note 1: Value 0 means write to NAND Flash (Data will be saved after power off.) Value 1 means write to RAM (Data will not be saved after power off.)

Wiring Diagram:

RS-485 2W 8P RJ45 (Diagram 1 ~ Diagram 6)

Diagram 1

cMT Series **cMT3151**

eMT Series **eMT3070 / eMT3105 / eMT3120 / eMT3150**

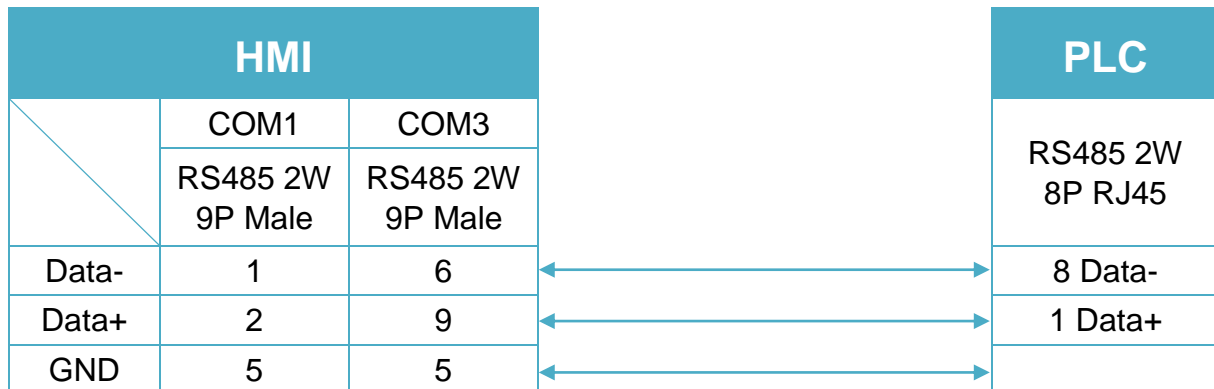


Diagram 2

cMT Series **cMT-SVR**

mTV **mTV**

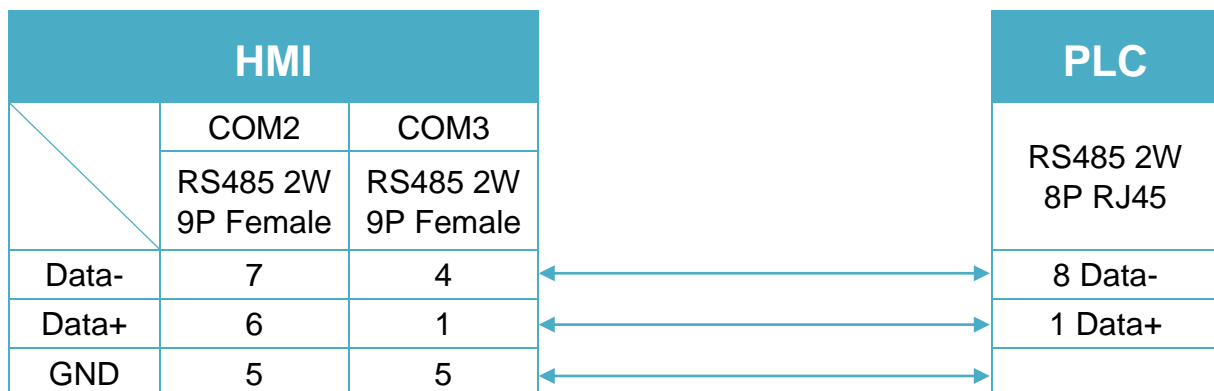


Diagram 3

MT-iE *MT8070iE / MT6070iE / MT8100iE / MT8121iE / MT8150iE*

MT-XE *MT8121XE / MT8150XE*

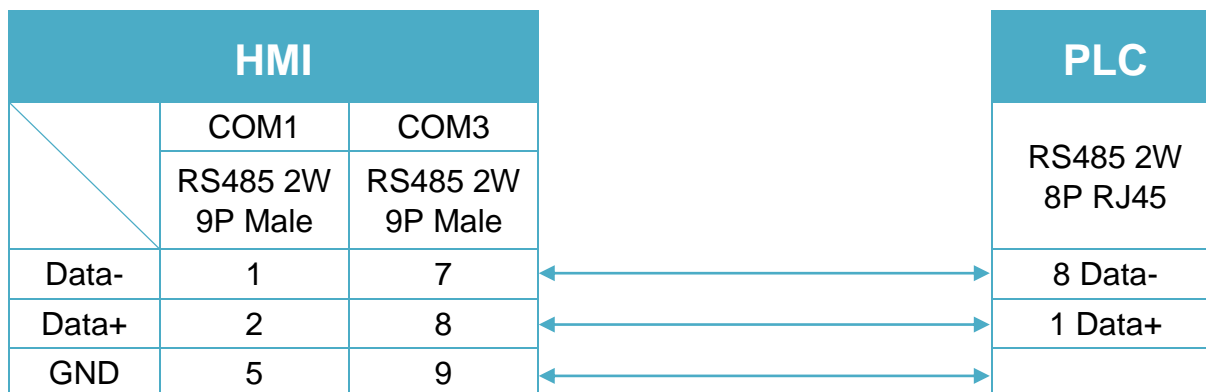


Diagram 4

MT-iE *MT8071iE / MT6071iE / MT8072iE / MT6072iE / MT8073iE /
MT8101iE / MT8102iE / MT8103iE*

MT-XE *MT8090XE / MT8092XE*

MT-iP *MT6103iP*

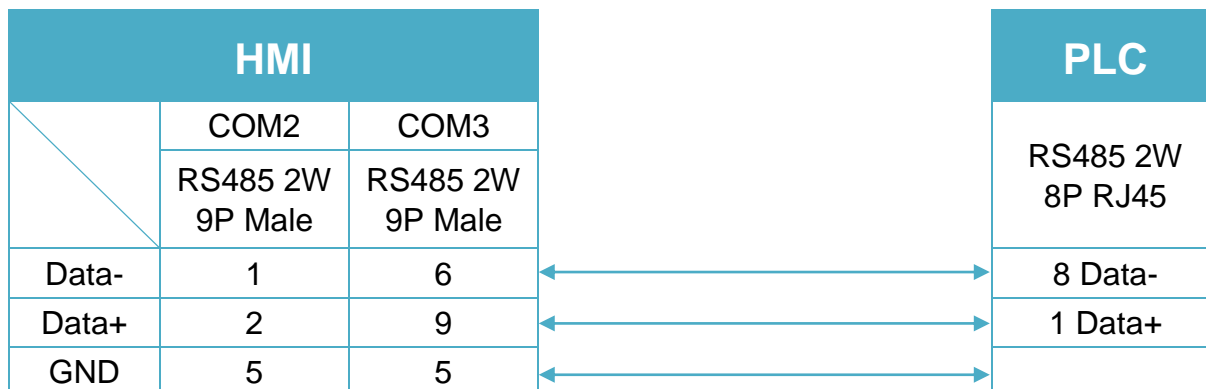


Diagram 5

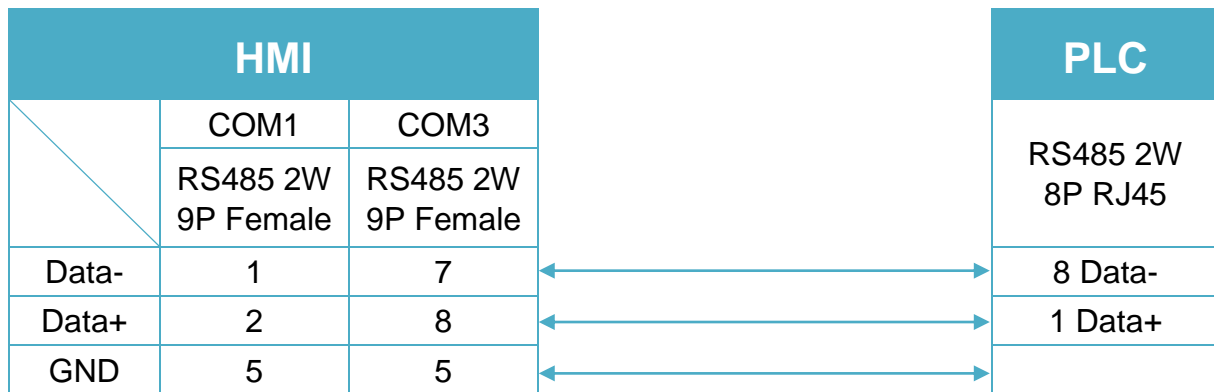
MT-iE *MT8050iE*
MT-iP *MT6051iP*


Diagram 6

MT-iP *MT6071iP / MT8071iP*


RS-485 2W Terminal (Diagram 7 ~ Diagram 12)

Diagram 7

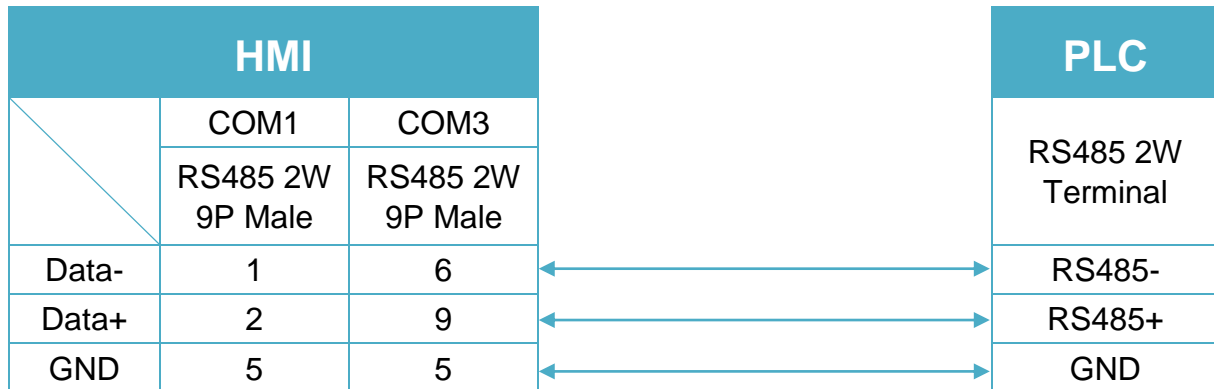
cMT Series
cMT3151
eMT Series
eMT3070 / eMT3105 / eMT3120 / eMT3150


Diagram 8

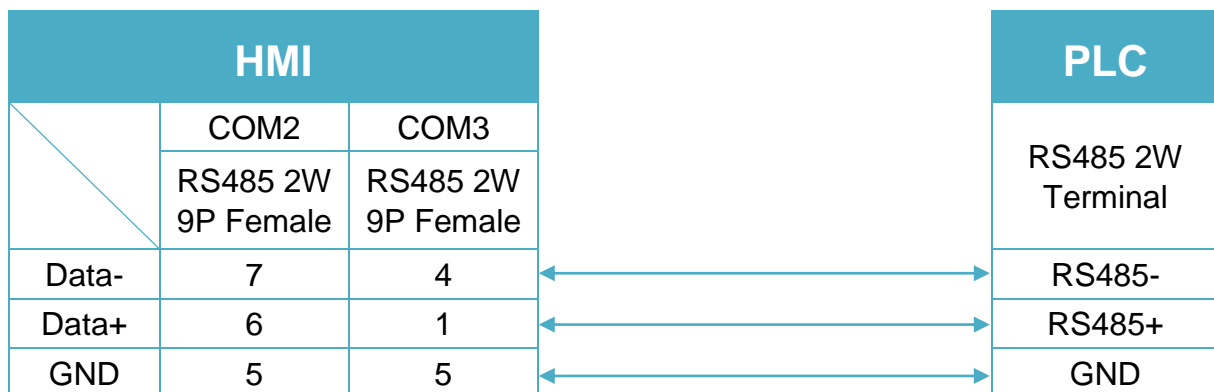
cMT Series
cMT-SVR
mTV
mTV


Diagram 9

MT-iE *MT8070iE / MT6070iE / MT8100iE / MT8121iE / MT8150iE*

MT-XE *MT8121XE / MT8150XE*

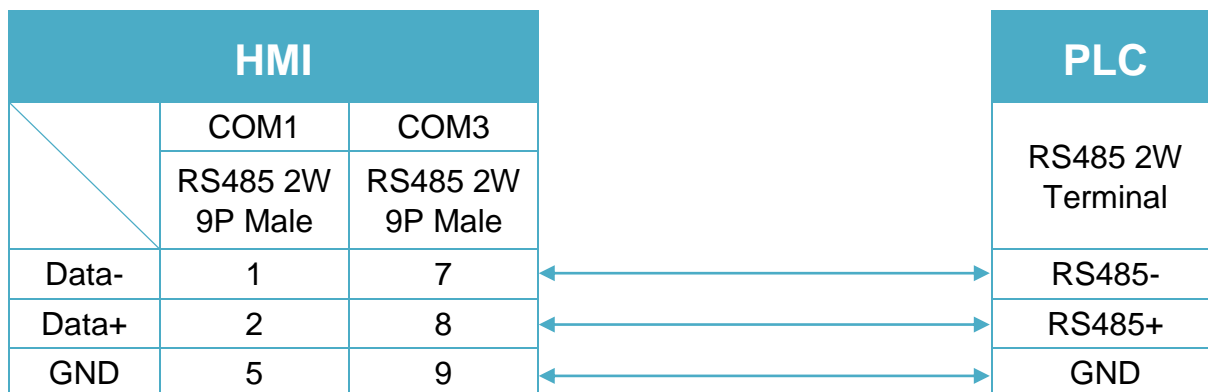


Diagram 10

MT-iE *MT8071iE / MT6071iE / MT8072iE / MT6072iE / MT8073iE / MT8101iE / MT8102iE / MT8103iE*

MT-XE *MT8090XE / MT8092XE*

MT-iP *MT6103iP*

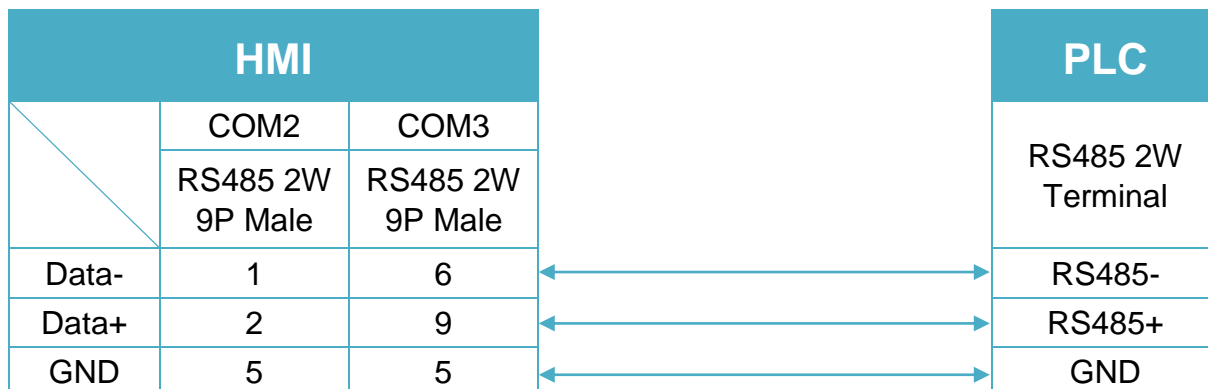


Diagram 11

MT-iE **MT8050iE**

MT-iP **MT6051iP**

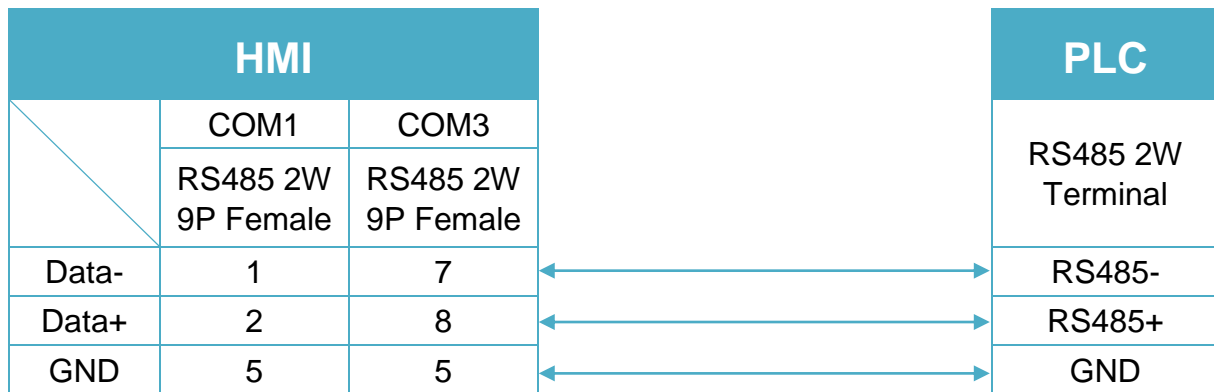


Diagram 12

MT-iP **MT6071iP / MT8071iP**



BACnet/IP

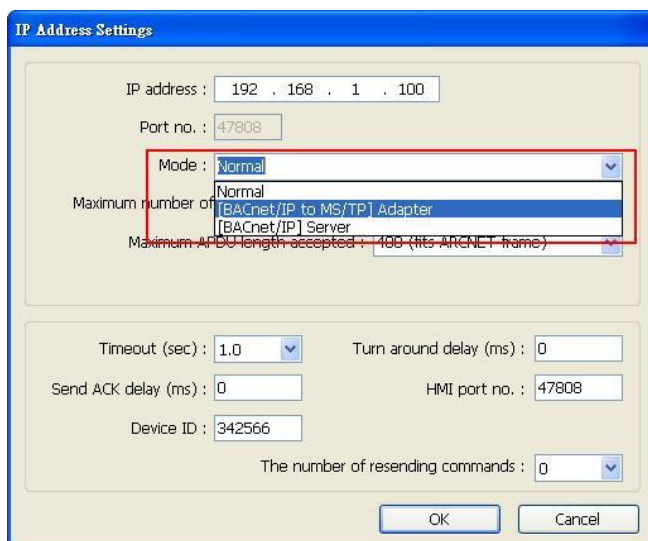
Supported series: BACnet/IP protocol devices

HMI Setting:

Parameters	Recommended	Options	Notes
PLC type	BACnet/IP		
PLC I/F	Ethernet		
Port no.	47808		47808 is the standard communication port of BACnet protocol.
HMI port no.	47808	49152~65535	Different HMI ports are required when connecting multiple
Device ID	342566	0~999999	According to device.
PLC sta. no.	1		

BACnet/IP to MS/TP Adapter Setting:

- When using BACnet/IP driver, please correctly set “Mode”, “Maximum number of segments accepted”, and “Maximum APDU length accepted” according to the actual device.



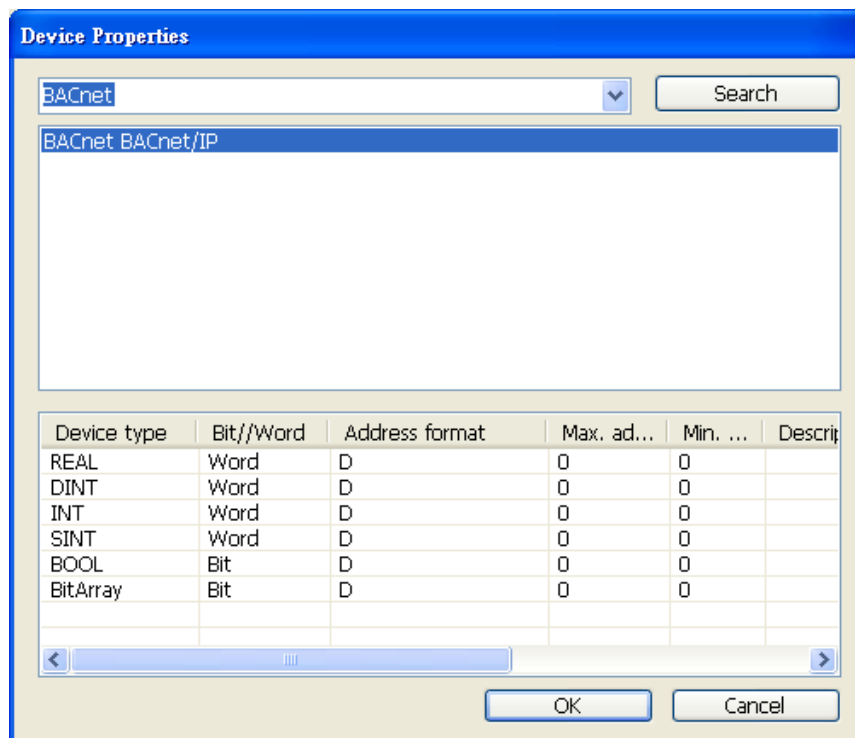
BACnet/IP to MS/TP adapter

2. As shown above, in BACnet/IP to MS/TP Adapter mode, [Network number] must follow the factory setting, and enter the device station number in [Device ID].
3. [HMI port no]. default: 47808, can be filled in other effective value.

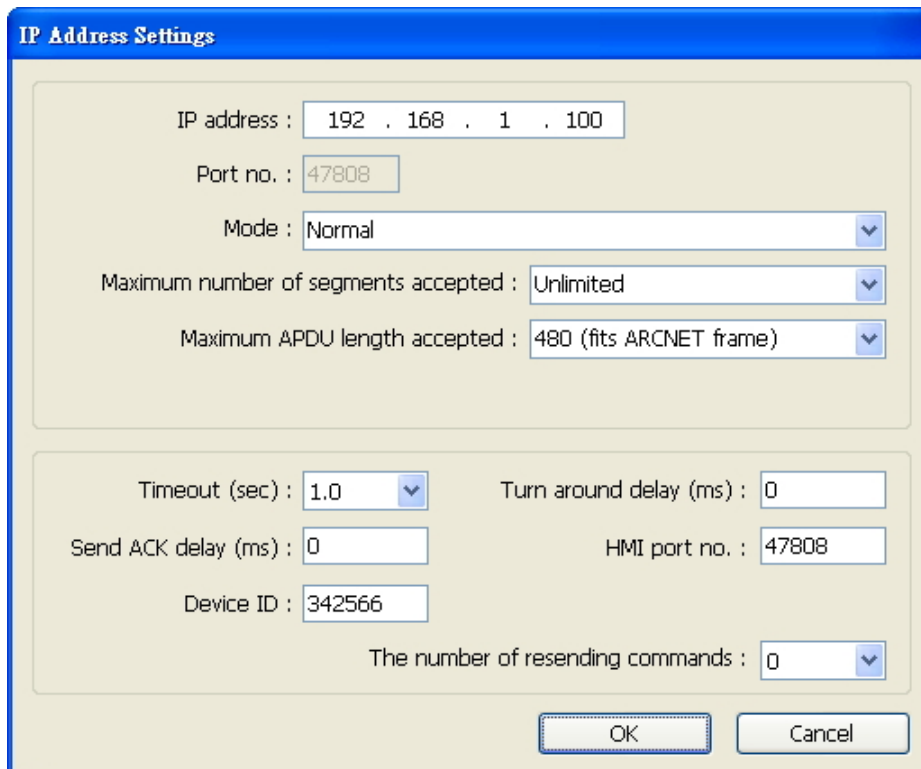
How to Import Tags:

EasyBuilder Pro provides two ways to gain tag addresses. One is to directly get tag information via internet, another is to export the generated CSV file via SCADA, and then import to EasyBuilder Pro. The following introduces how to import tag address information.

Step 1. Add BACnet/IP driver in System Parameters Settings



Step 2. Correctly set the relevant parameters.



IP Address Settings

IP address : 192 . 168 . 1 . 100

Port no. : 47808

Mode : Normal

Maximum number of segments accepted : Unlimited

Maximum APDU length accepted : 480 (fits ARCNET frame)

Timeout (sec) : 1.0

Turn around delay (ms) : 0

Send ACK delay (ms) : 0

HMI port no. : 47808

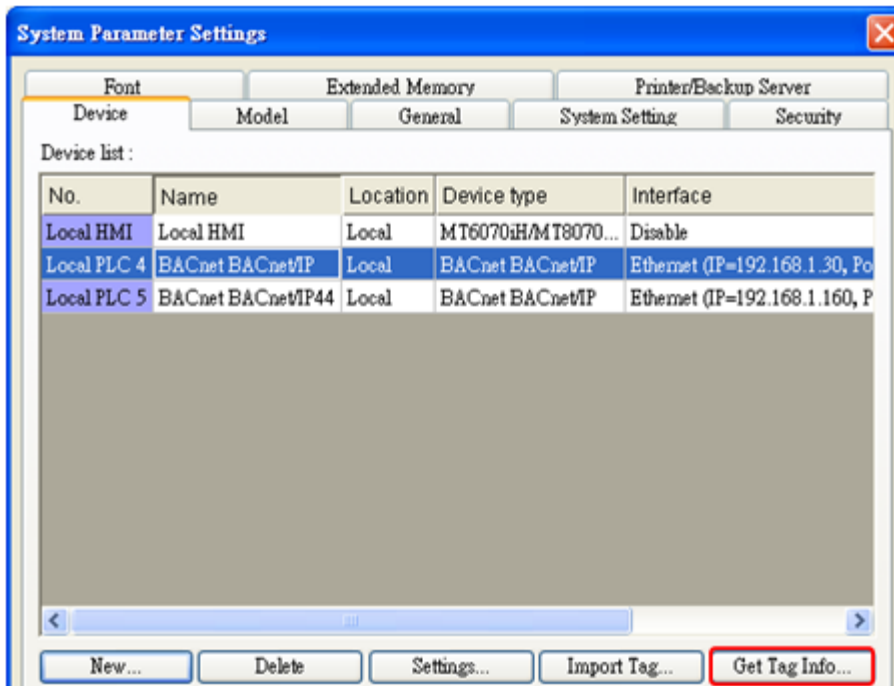
Device ID : 342566

The number of resending commands : 0

OK Cancel

Step 3. Get tag address information

Way 1: Click **Get Tag Info**.



System Parameter Settings

Font Extended Memory Printer/Backup Server

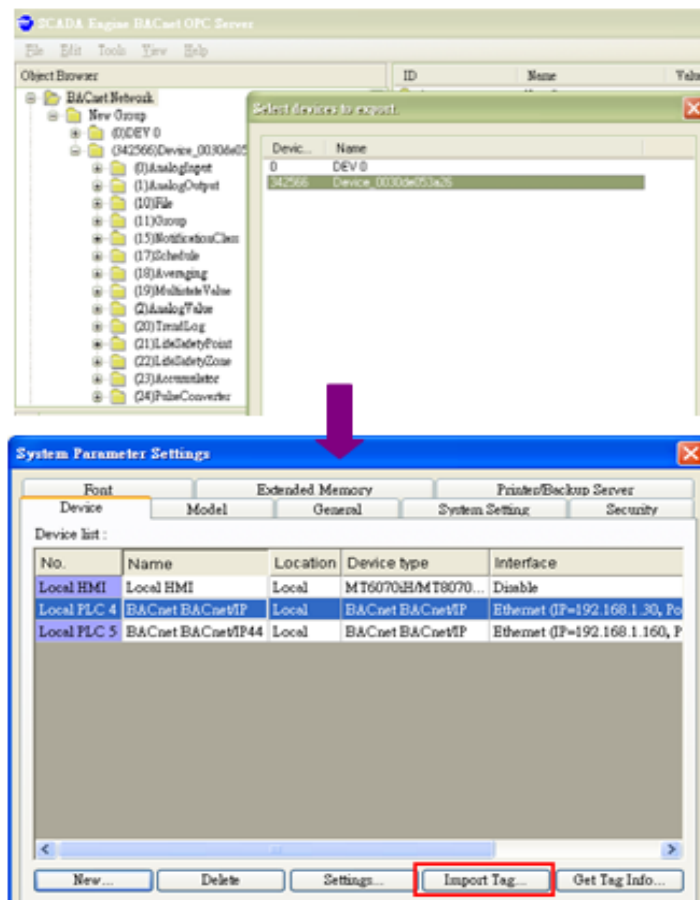
Device Model General System Setting Security

Device list :

No.	Name	Location	Device type	Interface
Local HMI	Local HMI	Local	MT6070iH/MT8070...	Disable
Local PLC 4	BACnet BACnet/IP	Local	BACnet BACnet/IP	Ethernet (IP=192.168.1.30, Po
Local PLC 5	BACnet BACnet/IP44	Local	BACnet BACnet/IP	Ethernet (IP=192.168.1.160, P

New... Delete Settings... Import Tag... **Get Tag Info...**

Way 2: Import the CSV file generated by SCADA software.

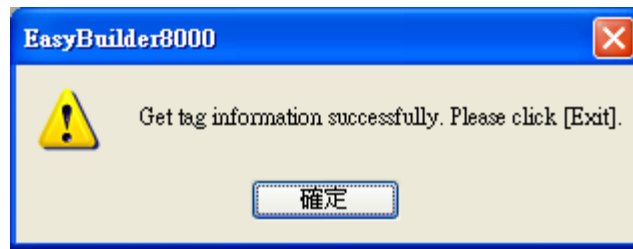


CSV file content is shown below; users can build the file and import:

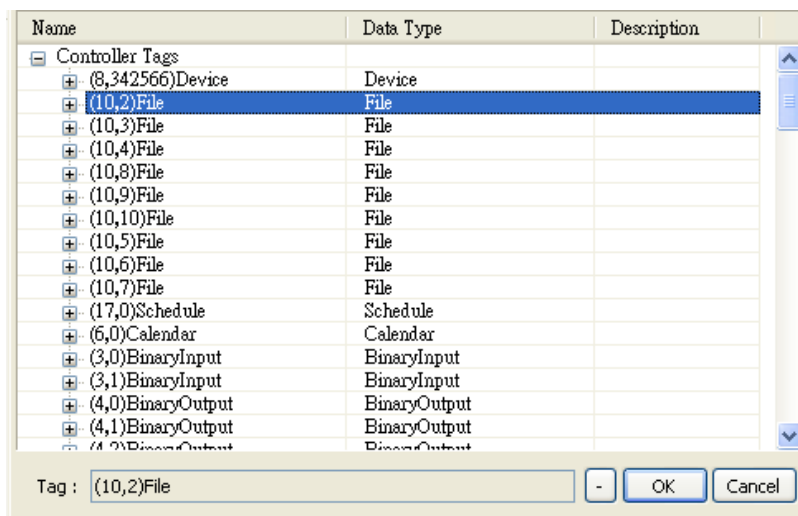
- Object format
- OBJECT NAME (user defined tag name, EasyBuilder will start reading data from the 6th row of CSV file.), DEVICE ID, OBJECT TYPE(object ID) and INSTANCE(object address)

A1		GROUP_ID		
A	B	C	D	
1	GROUP_ID	GROUP_NAME		a
2		1 New Group		
3	DEVICE_ID	GROUP_ID	DEVICE_NAME	
4	342566	1	Device_0030de053a26	
5	DEVICE_ID	OBJECT_TYPE	INSTANCE	OBJECT_NAME
6	342566	0		0 ANALOG_INPUT_0
7	342566	0		1 ANALOG_INPUT_1
8	342566	0		2 ANALOG_INPUT_2
9	342566	1		0 ANALOG_OUTPUT_0
10	342566	1	b	1 ANALOG_OUTPUT_1
11	342566	1		2 ANALOG_OUTPUT_2
12	342566	2		0 ANALOG_VALUE_0
13	342566	2		1 ANALOG_VALUE_1
14	342566	2		2 ANALOG_VALUE_2
15	342566	2		3 ANALOG_VALUE_3
16	342566	3		0 BINARY_INPUT_0
17	342566	3		1 BINARY_INPUT_1
18	342566	3		2 BINARY_INPUT_2
19	342566	3		3 BINARY_INPUT_3
20	342566	3		4 BINARY_INPUT_4
21	342566	3		5 BINARY_INPUT_5

Step 4. File imported successfully.



Take **(10·2)File** as an example, **10** represents object ID, **2** represents object address, **File** represents user defined name or default name.



Default Object Model:

Object ID	Object Name	Object Structure
0	Analog Input	Object Name Object Identifier Object Type Present Value Event State Out Of Service Units Min Press Value Max Press Value Cov Increment Resolution High Limit Low Limit

Object ID	Object Name	Object Structure
		Dead Band Profile Name
1	Analog Output	Object Name Object Identifier Object Type Present Value Event State Out Of Service Units Relinquish Default Min Press Value Max Press Value Cov Increment Resolution High Limit Low Limit Dead Band Profile Name
2	Analog Value	Object Name Object Identifier Object Type Present Value Event State Out Of Service Units Relinquish Default Cov Increment High Limit Low Limit Dead Band Profile Name
3	Binary Input	Object Name Object Identifier Object Type Present Value Event State Out Of Service Polarity

Object ID	Object Name	Object Structure
		Profile Name Notify Type Alarm Value
4	Binary Output	Object Name Object Identifier Object Type Present Value Event State Out Of Service Polarity Profile Name Notify Type
5	Binary Value	Object Name Object Identifier Object Type Present Value Event State Out Of Service Profile Name Notify Type Alarm Value
6	Calendar	Object Name Object Identifier Object Type Present Value
7	Command	Object Name Object Identifier Object Type Present Value In Process All Writes Successful
8	Device	Object Name Object Identifier Object Type System Status Vendor Name Vendor Identifier Model Name

Object ID	Object Name	Object Structure
		Firmware Revision Application Software Version Protocol Version Protocol Revision Max APDU length Accepted Segmentation Supported Apdu Timeout Number Of APDU retries Data Base Revision Max Segments Accepted Day light Savings Status Apdu Segment Timeout Backup Failure Timeout
10	File	Object Name Object Identifier Object Type File Type File Size Archive Read Only
11	Group	Object Name Object Identifier Object Type
13	Multi State Input	Object Name Object Identifier Object Type Present Value Event State Out Of Service Reliability Number Of States Time Delay Notification Class Notify Type Profile Name
14	Multi State Output	Object Name Object Identifier Object Type

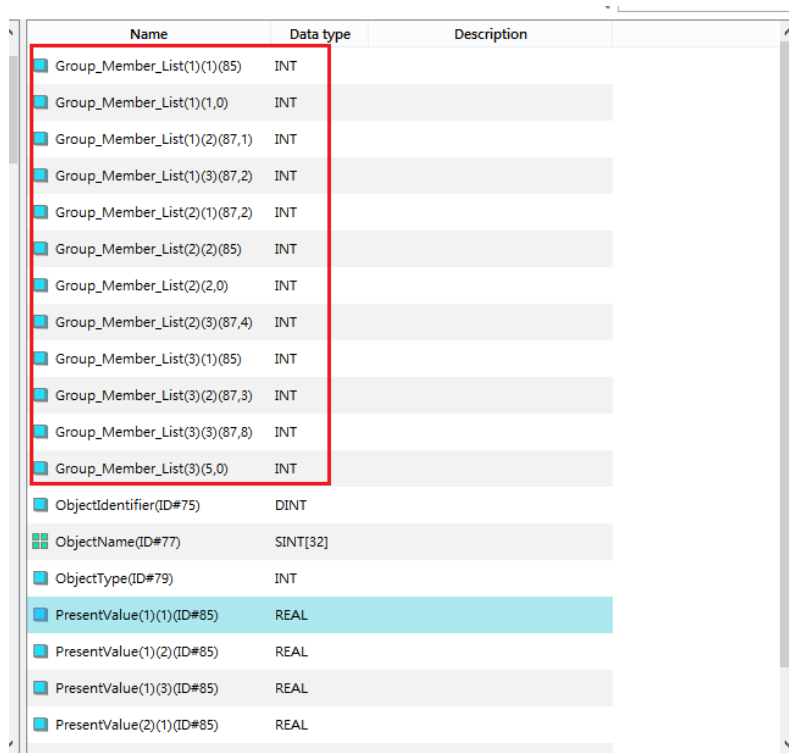
Object ID	Object Name	Object Structure
		Present Value Event State Out Of Service Reliability Number Of States Time Delay Notification Class Notify Type Profile Name
15	Notification Class	Object Name Object Identifier Object Type Notification Class Priority
17	Schedule	Object Name Object Identifier Object Type Present Value Priority For Writing Reliability Out Of Service
18	Averaging	Object Name Object Identifier Object Type Minimum Value Average Value Maximum Value Attempted Samples Valid Samples Window Interval Window Samples
19	Multi State Value	Object Name Object Identifier Object Type Present Value Event State Out Of Service Reliability

Object ID	Object Name	Object Structure
		Number Of States Notification Class Notify Type Profile Name Time Delay
20	Trend Log	Object Name Object Identifier Object Type Enable Stop When Full Buffer Size Record Count Total Record Count
21	Life Safety Point	Object Name Object Identifier Object Type Present Value Tracking Value Event State Reliability Out Of Service Mode Silenced
22	Life Safety Zone	Object Name Object Identifier Object Type Present Value Tracking Value Event State Reliability Out of Service Mode Silenced
23	Accumulator	Object Name Object Identifier Object Type Present Value Event State

Object ID	Object Name	Object Structure
		Out Of Service Scale Units Reliability
24	Pulse Converter	Object Name Object Identifier Object Type Present Value Event State Out Of Service Units Scale Factor Adjust Value High Limit Low Limit Dead Band Cov Increment Count

Note 1. Object name can not include “#”.

Note 2 Group objects can only communicate when the Group_Member_List addresses are placed in the project editing screen.



Name	Data type	Description
Group_Member_List(1)(1)(85)	INT	
Group_Member_List(1)(1,0)	INT	
Group_Member_List(1)(2)(87,1)	INT	
Group_Member_List(1)(3)(87,2)	INT	
Group_Member_List(2)(1)(87,2)	INT	
Group_Member_List(2)(2)(85)	INT	
Group_Member_List(2)(2,0)	INT	
Group_Member_List(2)(3)(87,4)	INT	
Group_Member_List(3)(1)(85)	INT	
Group_Member_List(3)(2)(87,3)	INT	
Group_Member_List(3)(3)(87,8)	INT	
Group_Member_List(3)(5,0)	INT	
ObjectIdentifier(ID#75)	DINT	
ObjectName(ID#77)	SINT[32]	
ObjectType(ID#79)	INT	
PresentValue(1)(1)(ID#85)	REAL	
PresentValue(1)(2)(ID#85)	REAL	
PresentValue(1)(3)(ID#85)	REAL	
PresentValue(2)(1)(ID#85)	REAL	

Wiring Diagram:

Diagram 1

Ethernet cable:



BACnet/IP Server

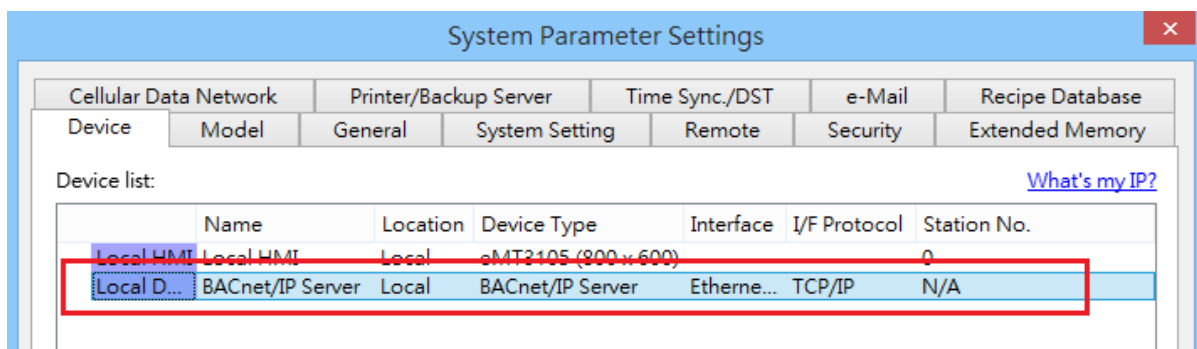
Supported series: BACnet/IP protocol devices

HMI Setting:

Parameters	Recommended	Options	Notes
PLC type	BACnet/IP Server		
PLC I/F	Ethernet		
Port no.	47808		47808 is the standard communication port of BACnet protocol.
HMI Device ID	4194302	0 ~ 4194302	

The following steps explain how to build the tag list.

1. In [System Parameter Settings] add [BACnet/IP Server] driver.



2. Click [Tag Manager].



3. Configure tag information as shown below.

3.1 HMI Device ID: Set the range to 0 ~ 4194302.

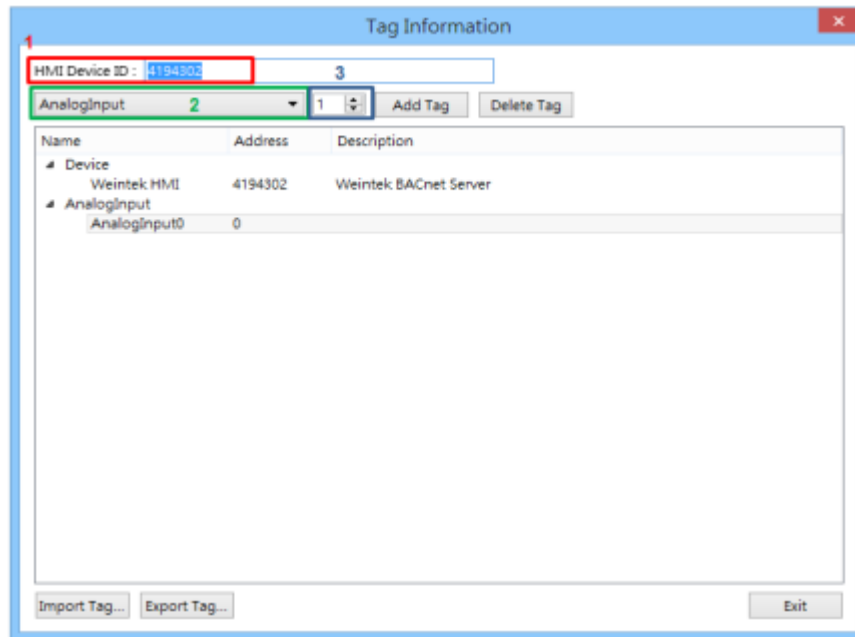
3.2 Tag Name: Add these tags: Analog Input, Analog Output, Analog Value, Binary Input, Binary Output, Binary Value

3.3 Specify the quantity of the selected tag, the allowable range: 1 ~ 100

3.4 [Add Tag]: According to the selected tag and the specified quantity, the added tags will be shown in the list.

3.5 [Delete Tag]: Delete a single tag or multiple tags.

3.6 [Import Tag] [Export Tag]: Import an existing CSV file or export current data as a CSV file. Please note that current data will be removed after importing a CSV file.



Object:

Object ID	Object Name	Object Structure
0	Analog Input	Description Object Identifier Object Name Object Type Present Value Units
1	Analog Output	Description Object Identifier Object Name Object Type Present Value Priority Priority Array Units Priority Reset
2	Analog Value	Description Object Identifier Object Name Object Type Present Value Priority

Object ID	Object Name	Object Structure
		Priority Array Units Priority Reset
3	Binary Input	Description Object Identifier Object Name Object Type Units Present Value
4	Binary Output	Description Object Identifier Object Name Object Type Priority Units Present Value Priority Array Priority Reset
5	Binary Value	Description Object Identifier Object Name Object Type Priority Units Present Value Priority Array Priority Reset

Wiring Diagram:

Diagram 1

Ethernet cable:



BACnet/MSTP

Supported series: BACnet/MSTP protocol devices

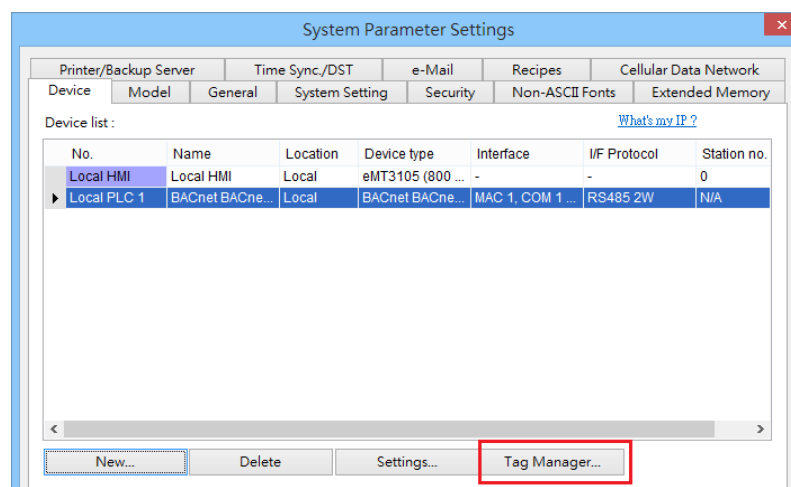
HMI Setting:

Parameters	Recommended	Options	Notes
PLC type	BACnet/MSTP		
PLC I/F	RS485-2W		
Baud rate	38400	9600,19200, 38400	
Data bits	8		
Parity	None		
Stop bits	1		
Time out (sec)	0.05	0.05 ~ 0.1	
Token wait time (ms)	50	20 ~ 100	
MAC	0	0 ~ 254	
HMI MAC	1	1 ~ 127	
Nmax_master	127	2 ~ 127	
Npoll	50	1 ~ 255	

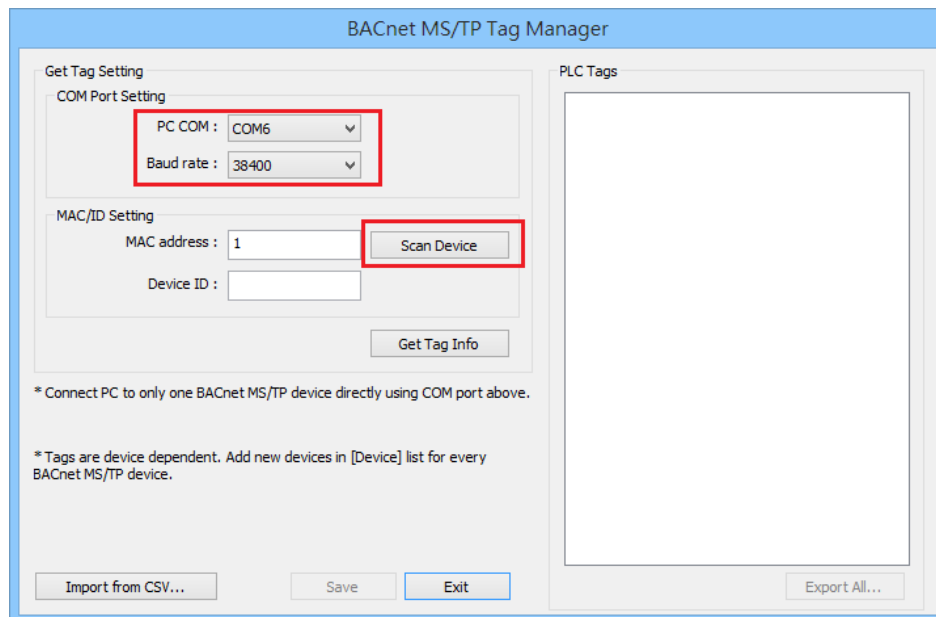
Online simulator	NO	Extend address mode	NO
-------------------------	----	----------------------------	----

How to Import Tags:

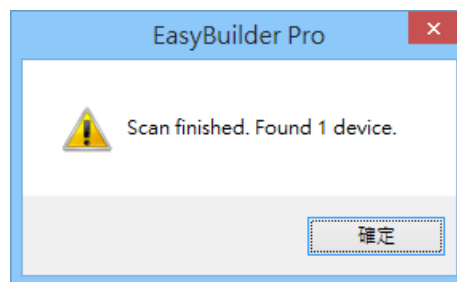
1. In EasyBuilder **System Parameter Settings** add **BACnet/MSTP** driver, set the communication parameters, and then click **Tag Manager** button.



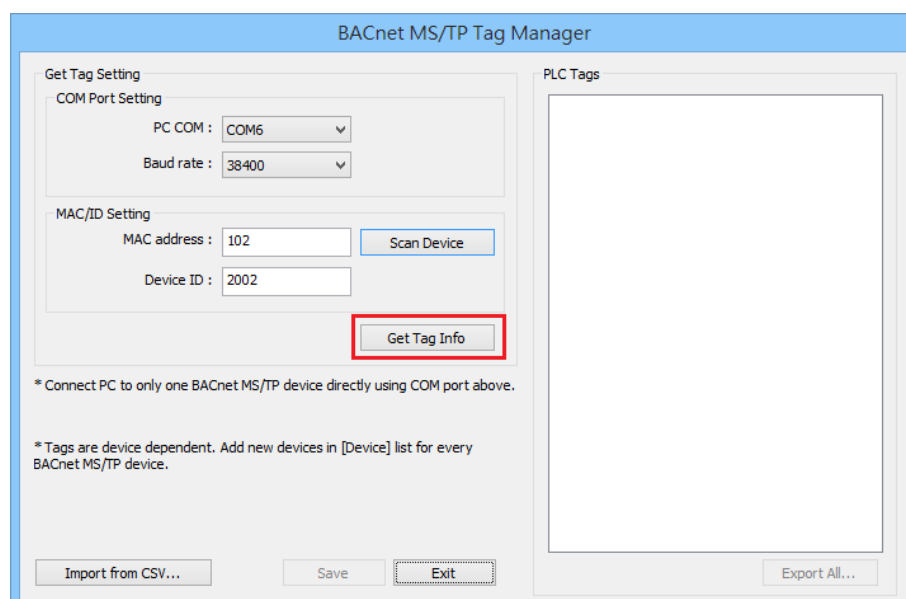
- Use a RS-232/RS-485 converter to connect the BACnet MS/TP unit with PC. Only one BACnet MS/TP unit is allowed. Set **PC COM** and **Baud rate**, click **Scan Device** button to find the **MAC address** and **Device ID** of the BACnet MS/TP unit.



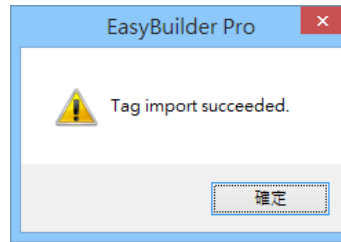
- If the device is found, the following message shows, click **OK**.



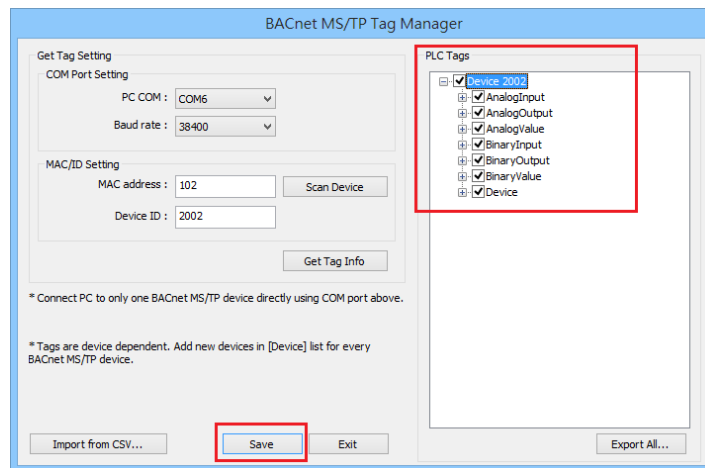
- After getting the **MAC address** and **Device ID**, click **Get Tag Info** button to get the address tags.



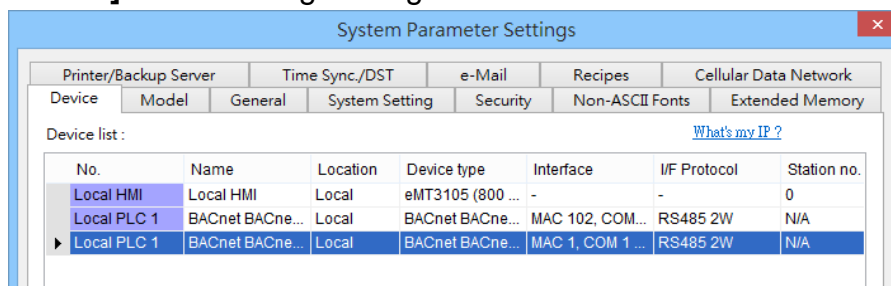
5. If the tags are obtained successfully, the following message shows, click **OK**.



6. In the **PLC Tags** field, the tags with its check box selected can be imported. After selecting the tags, click **Save**, and then click **Export All**, to save the address tags as CSV file. When finished, click **Exit** to finish importing address tags.



7. To connect another BACnet/MSTP unit, please add the **BACnet/MSTP** driver in EasyBuilder System Parameter Settings again. The communication parameters will follow the settings of the firstly added unit. The way to get tag information is the same as illustrated in the preceding steps. Another way to get tag information is to click **[Import form CSV]** button in Tag Manager.



Notes:

1. The MAC address and Device ID of certain BACnet MS/TP units can be gained by clicking [Scan Device] only at the first time the unit is powered up. To get this information in the same way again, please power up the unit again.

2. Certain BACnet MS/TP units do not support [Scan Device] and [Get Tag Info].
3. If the MAC address gained by clicking [Scan Device] does not match the one specified in EasyBuilder Pro Device Properties settings, a message shows as a reminder when [Get Tag Info] is clicked.

Default Object Model:

Object ID	Object Name	Object Structure
0	Analog Input	Object Name Object Identifier Object Type Present Value Present Value Array Units
1	Analog Output	Object Name Object Identifier Object Type Present Value Present Value Array Units Priority Priority Array Relinquish Default SubscribeCovTime
2	Analog Value	Object Name Object Identifier Object Type Present Value Present Value Array Units Priority Priority Array Relinquish Default SubscribeCovTime
3	Binary Input	Object Name Object Identifier Object Type Present Value Present Value Array

Object ID	Object Name	Object Structure
		SubscribeCovTime
4	Binary Output	Object Name Object Identifier Object Type Present Value Present Value Array Priority Priority Array Polarity SubscribeCovTime
5	Binary Value	Object Name Object Identifier Object Type Present Value Present Value Array Priority Priority Array SubscribeCovTime

Wiring Diagram:

RS-485 2W Terminal (Diagram 1 ~ Diagram 6)

Diagram 1

cMT Series

cMT3151

eMT Series

eMT3070 / eMT3105 / eMT3120 / eMT3150

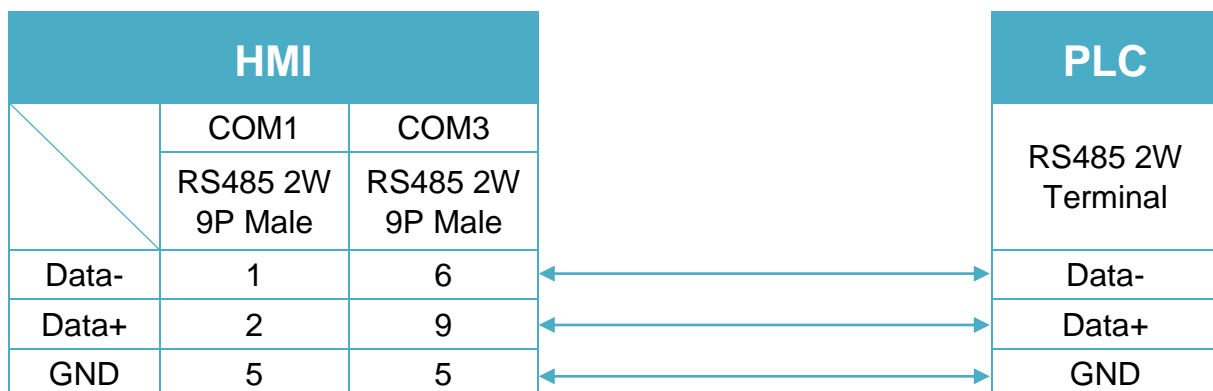


Diagram 2

cMT Series *cMT-SVR*

mTV *mTV*

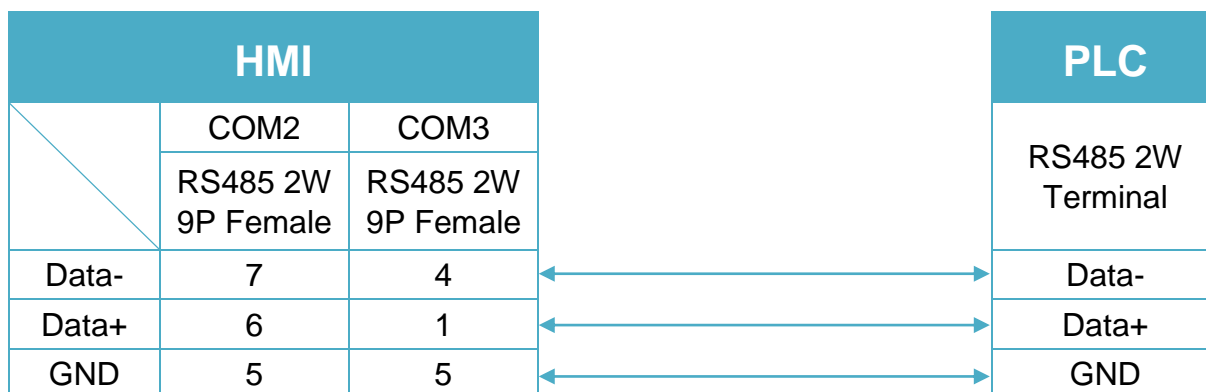


Diagram 3

MT-iE *MT8070iE / MT6070iE / MT8100iE / MT8121iE / MT8150iE*

MT-XE *MT8121XE / MT8150XE*

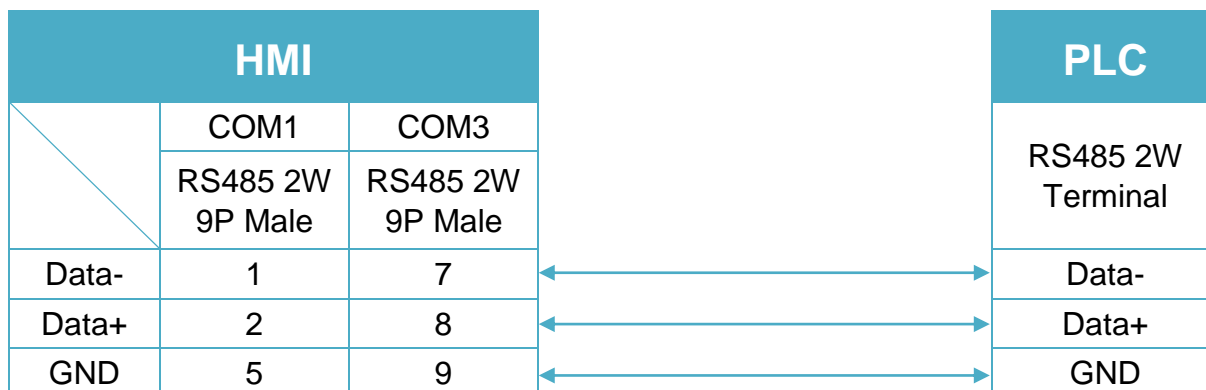
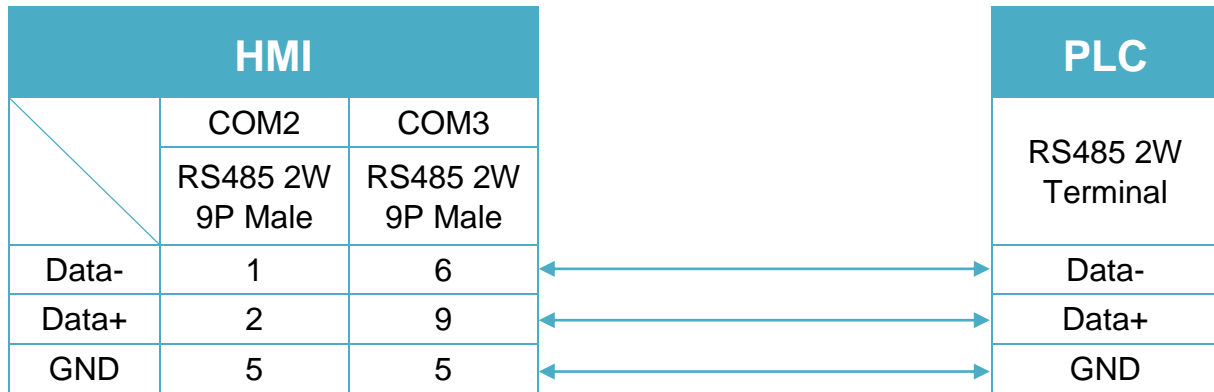


Diagram 4

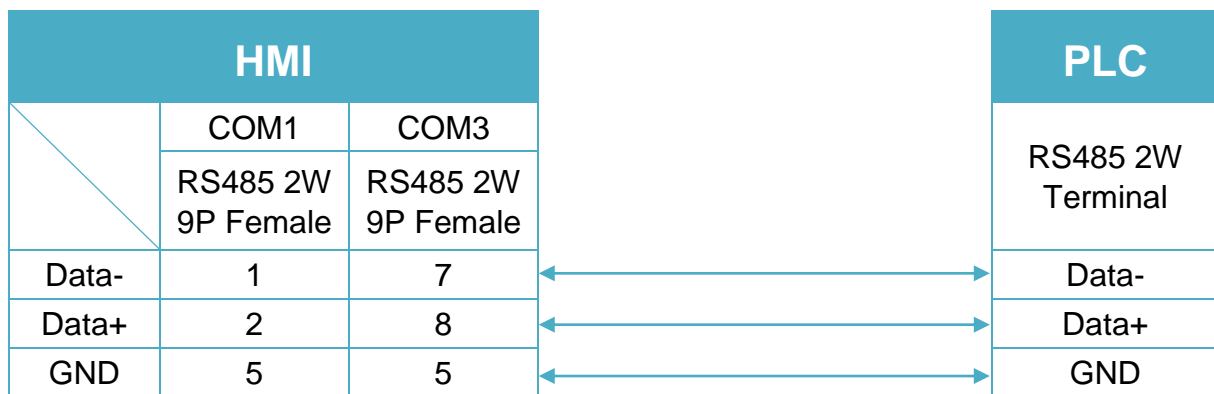
MT-iE *MT8071iE / MT6071iE / MT8072iE / MT6072iE / MT8073iE / MT8101iE / MT8102iE / MT8103iE*

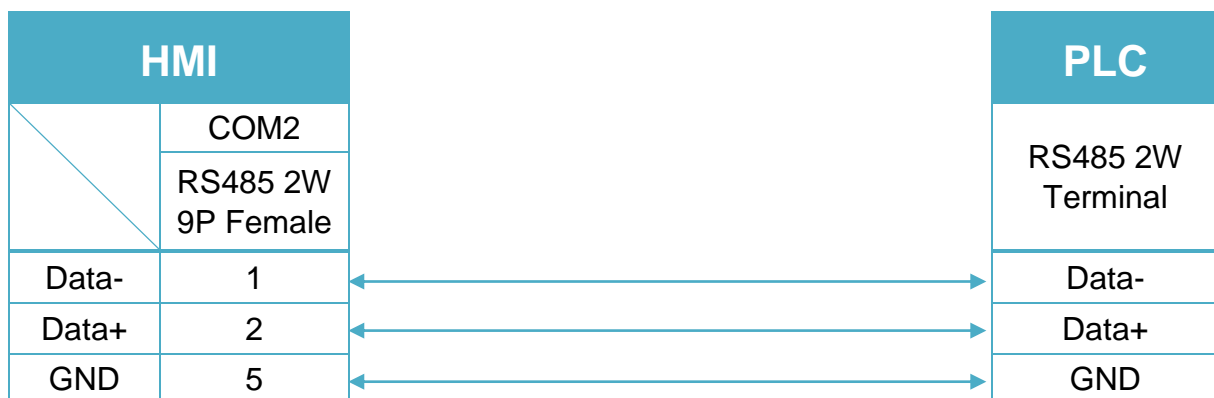
MT-XE *MT8090XE / MT8092XE*

MT-iP *MT6103iP*


Diagram 5

MT-iE *MT8050iE*

MT-iP *MT6051iP*

Diagram 6

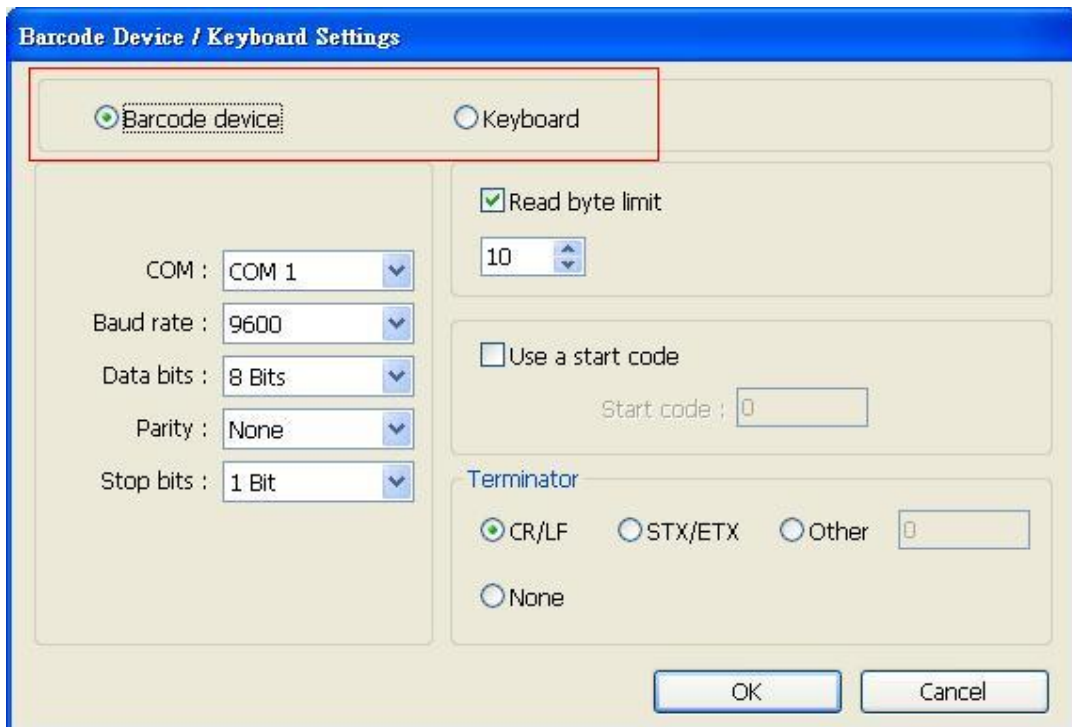
MT-iP *MT6071iP / MT8071iP*


Barcode/Keyboard (USB/COM)

HMI Setting:

Parameters	Recommended	Options	Notes
PLC type	Barcode/Keyboard (USB/COM)		
PLC I/F	RS232	RS232/485,USB	
Baud rate	9600	9600~115200	
Data bits	8	7,8	
Parity	None	None, Even, Odd	
Stop bits	1	1,2	
Terminator	CR/LF	CR/LF, STX/ETX, Other, None	

★When setting device properties, select [Barcode device] or [Keyboard] mode.



The image shows a dialog box titled "Barcode Device / Keyboard Settings". At the top, there are two radio buttons: "Barcode device" (which is selected) and "Keyboard". Below this, the settings are organized into several sections:

- COM:** A dropdown menu set to "COM 1".
- Baud rate:** A dropdown menu set to "9600".
- Data bits:** A dropdown menu set to "8 Bits".
- Parity:** A dropdown menu set to "None".
- Stop bits:** A dropdown menu set to "1 Bit".
- Read byte limit:** A checked checkbox with a value of "10" in a spin box.
- Use a start code:** An unchecked checkbox with a "Start code" input field set to "0".
- Terminator:** Radio buttons for "CR/LF" (selected), "STX/ETX", and "Other" (with an input field set to "0"), and a "None" option.

At the bottom right, there are "OK" and "Cancel" buttons.

Device Address:

Bit/Wor	Device type	Format	Range	Memo
B	FLAG	DD	0 ~ 17	Flag
B	RESET	O	0	*Note 1
B	CONNECT_STATUS	O	0	
W	BARCODE 1	DD	0 ~ 255	String
W	RESULT	D	0	*Note 2



1. RESET: If set on, clears the data of BARCODE and RESULT, and clears FLAG to OFF.
2. RESULT: Indicates the result of data reading.
The following values indicate:
 - 0 : Waiting to read BARCODE.
 - 1 : BARCODE is successfully read.
 - 2 : Invalid BARCODE format.
 - 3 : Exceeds the number of bytes specified in [Read byte limit].
 - 4 : The Start Code of the data read does not match the setting.
 - 5 : The Terminator of the data read does not match the setting.

Wiring Diagram:

RS-232 9P D-Sub (Diagram 1 ~ Diagram 3)

Diagram 1

cMT Series	<i>cMT3151</i>
eMT Series	<i>eMT3070 / eMT3105 / eMT3120 / eMT3150</i>
MT-iE	<i>MT8073iE / MT8102iE</i>
MT-XE	<i>MT8092XE</i>
MT-iP	<i>MT6103iP</i>

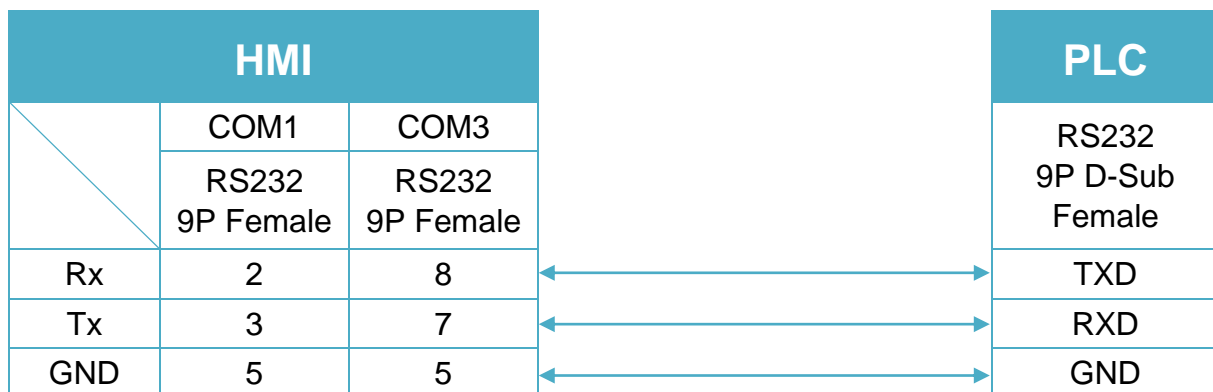


Diagram 2

cMT Series	cMT-SVR
mTV	mTV
MT-iE	MT8070iE / MT6070iE / MT8100iE / MT8121iE / MT8150iE / MT8071iE / MT6071iE / MT8072iE / MT6072iE / MT8073iE / MT8101iE / MT8102iE / MT8103iE
MT-XE	MT8121XE / MT8150XE / MT8090XE

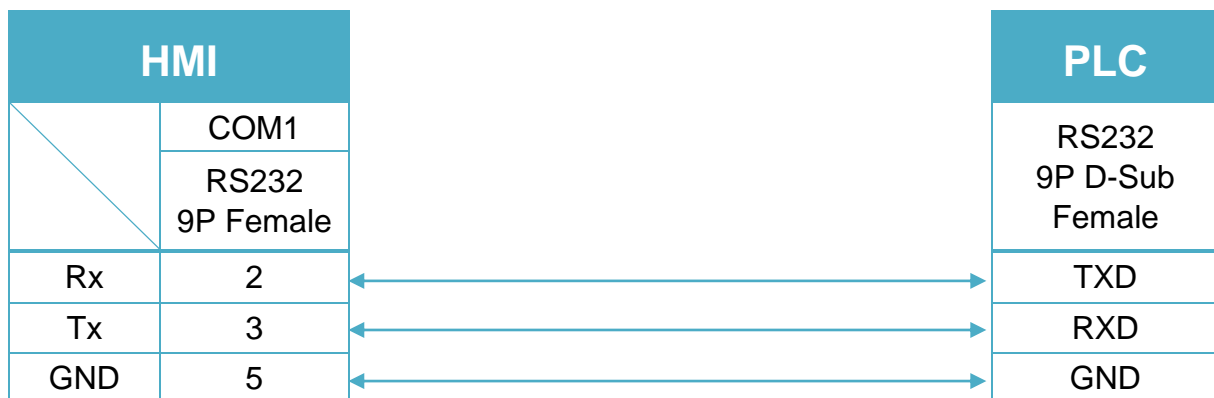
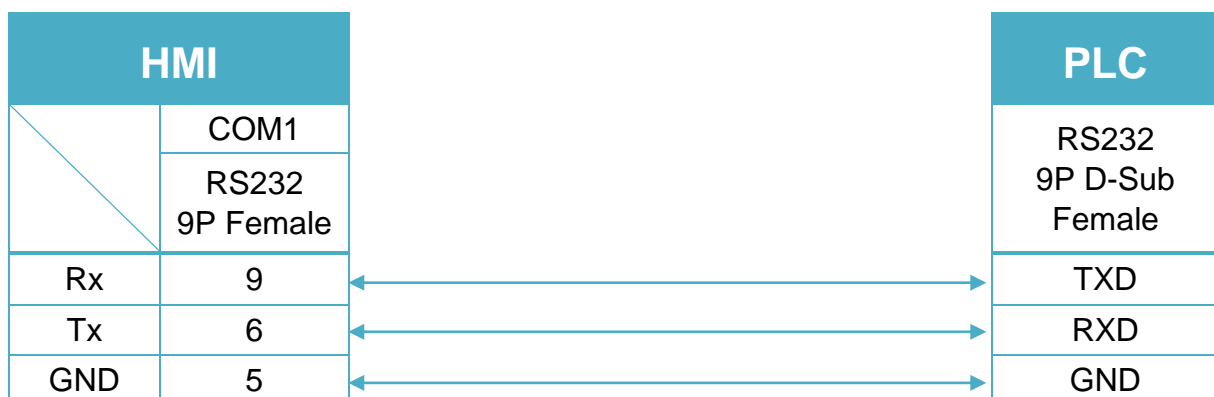


Diagram 3

MT-iE	MT8050iE
MT-iP	MT6051iP / MT6071iP / MT8071iP



Baumuller

Website: <http://www.baumuller.com/>

HMI Setting:

Parameters	Recommended	Options	Notes
PLC type	Baumuller		
PLC I/F	RS485 4W		
Baud rate	19200	9600, 19200	
Data bits	8	7 or 8	
Parity	Even	Even, Odd, None	
Stop bits	1	1 or 2	
HMI sta. no.	0		
PLC sta. no.	0	Defaults	

PLC Setting:

Communication mode	RK 512 Protocol, 19200, 8, 1, Even
---------------------------	------------------------------------

Device Address:

Bit/Word	Device type	Format	Range	Memo
B	DB0_bit ~ DB29_bit	DDDh	0 ~ 255f	
W	DB0 ~ DB29	DDD	0 ~ 255	

Wiring Diagram:

Baumuller Servo: RS-485 4W 9P D-Sub (Diagram 1 ~ Diagram 4)

Diagram 1

cMT Series	<i>cMT3151</i>
eMT Series	<i>eMT3070 / eMT3105 / eMT3120 / eMT3150</i>
MT-iE	<i>MT8070iE / MT6070iE / MT8100iE / MT8121iE / MT8150iE</i>
MT-XE	<i>MT8121XE / MT8150XE</i>

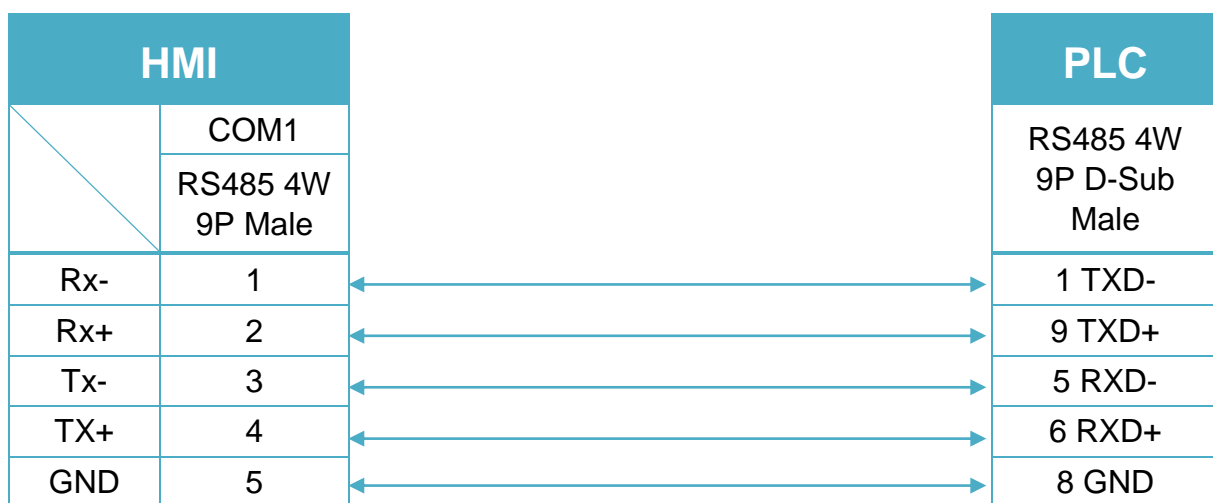


Diagram 2

cMT Series	<i>cMT-SVR</i>
mTV	<i>mTV</i>

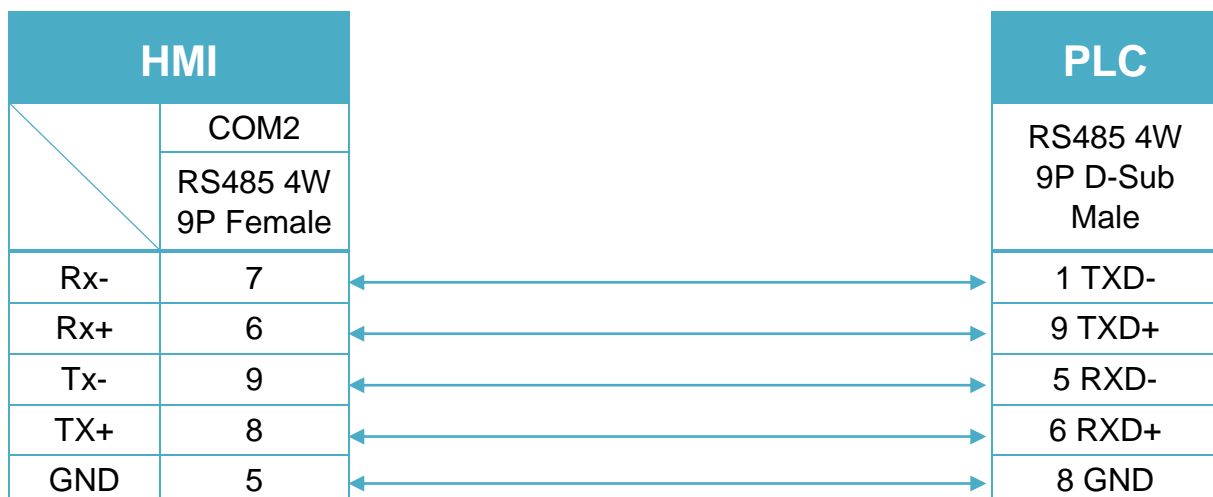


Diagram 3

MT-iE	<i>MT8071iE / MT6071iE / MT8072iE / MT6072iE / MT8073iE / MT8101iE / MT8102iE / MT8103iE</i>
MT-XE	<i>MT8090XE / MT8092XE</i>
MT-iP	<i>MT6071iP / MT8071iP / MT6103iP</i>

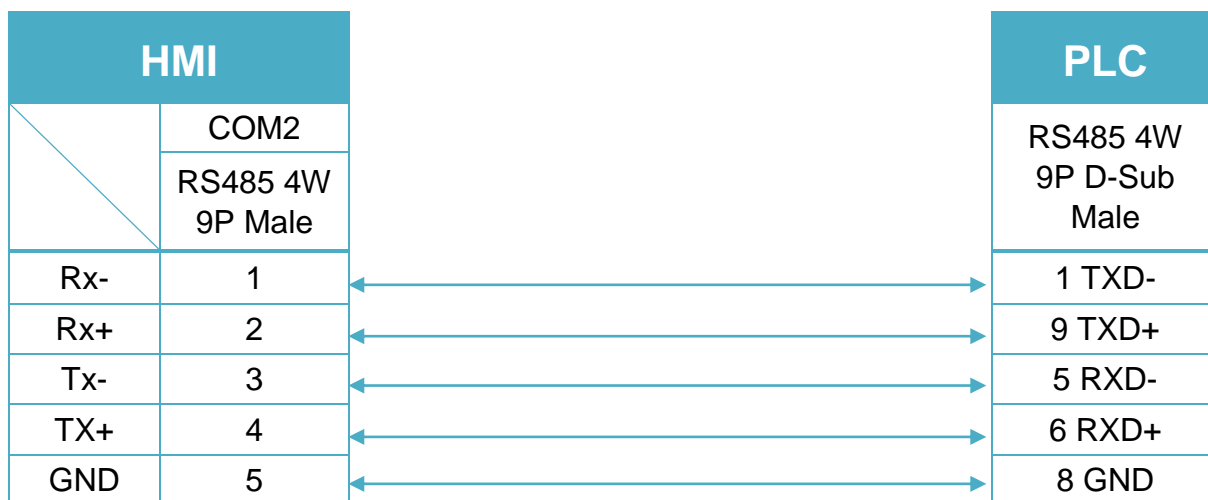


Diagram 4

MT-iE	<i>MT8050iE</i>
MT-iP	<i>MT6051iP</i>



Beckhoff ADS (Absolute Addressing)

Supported Series: TwinCAT

HMI Setting:

Parameters	Recommended	Options	Notes
PLC type	Beckhoff ADS (Absolute Addressing)		
PLC I/F	RS232		
Baud rate	38400		
Data bits	8		
Parity	Even		
Stop bits	1		
ADS Port	800	300, 800, 801, 811, 821, 831, 851 ~ 854	

Device Address:

Bit/Word	Device type	Format	Range	Memo
B	IX	DDDDDo	0 ~ 655357	
B	QX	DDDDDo	0 ~ 655357	
B	MX	DDDDDo	0 ~ 655357	
Byte	IB	DDDDD	0 ~ 65535	
Byte	QB	DDDDD	0 ~ 65535	
Byte	MB	DDDDD	0 ~ 65535	
W	IW	DDDDD	0 ~ 65535	
W	QW	DDDDD	0 ~ 65535	
W	MW	DDDDD	0 ~ 65535	
DW	ID	DDDDD	0 ~ 65535	
DW	QD	DDDDD	0 ~ 65535	
DW	MD	DDDDD	0 ~ 65535	

Wiring Diagram:

RS-232 9P D-Sub (Diagram 1 ~ Diagram 3)

Diagram 1

cMT Series	<i>cMT3151</i>
eMT Series	<i>eMT3070 / eMT3105 / eMT3120 / eMT3150</i>
MT-iE	<i>MT8073iE / MT8102iE</i>
MT-XE	<i>MT8092XE</i>
MT-iP	<i>MT6103iP</i>

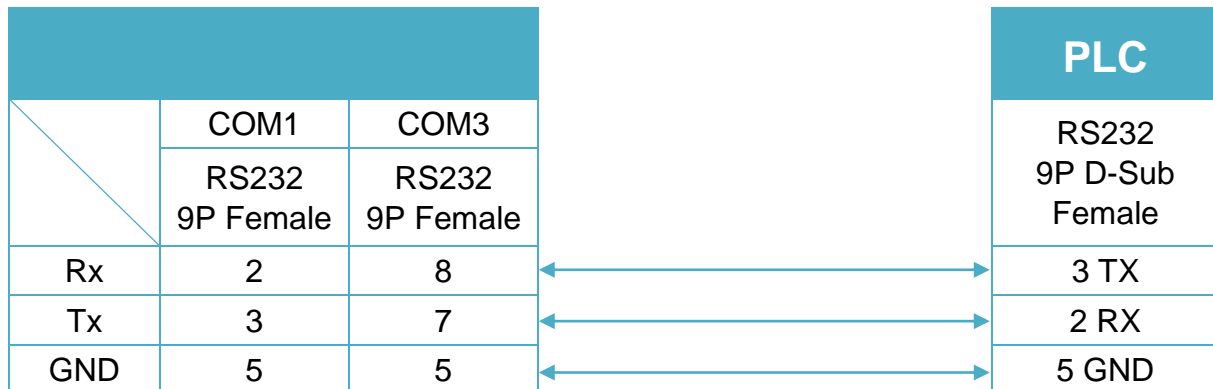


Diagram 2

cMT Series	<i>cMT-SVR</i>
mTV	<i>mTV</i>
MT-iE	<i>MT8070iE / MT6070iE / MT8100iE / MT8121iE / MT8150iE / MT8071iE / MT6071iE / MT8072iE / MT6072iE / MT8073iE / MT8101iE / MT8102iE / MT8103iE</i>
MT-XE	<i>MT8121XE / MT8150XE / MT8090XE</i>

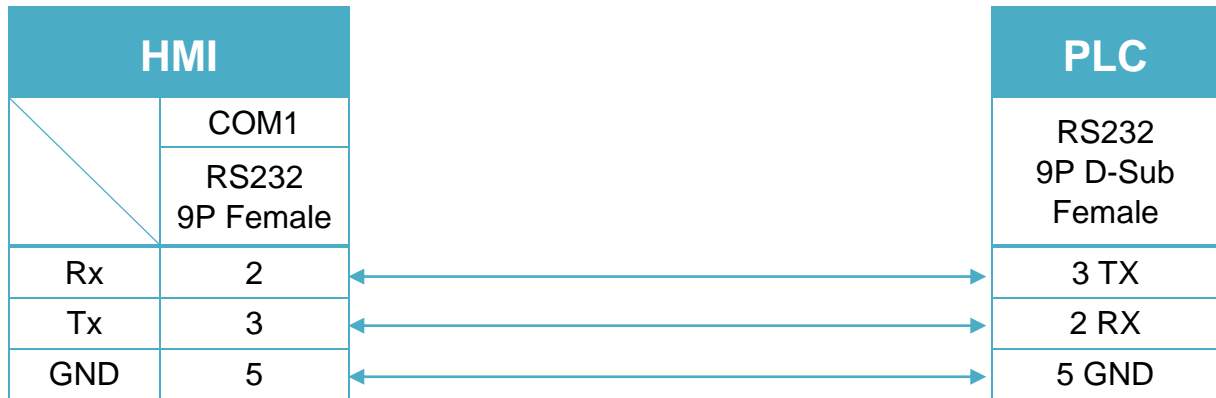


Diagram 3

MT-iE *MT8050iE*

MT-iP *MT6051iP / MT6071iP / MT8071iP*



Beckhoff ADS/AMS (Ethernet)

Supported Series: Twincat

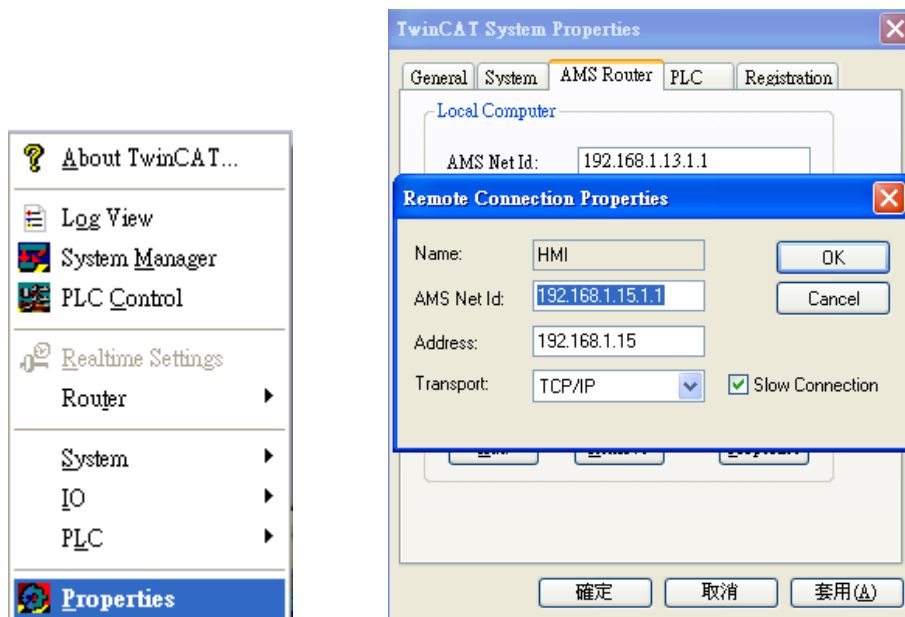
HMI Setting:

Parameters	Recommended	Options	Notes
PLC type	Beckhoff ADS/AMS (Ethernet)		
PLC I/F	Ethernet		
Port no.	48898		
ADS port	801	801, 811, 821, 831	
PLC sta. no.	1		

PLC Setting:

Step1.

Open TwinCAT System Properties.



PLC Settings: Set HMI Name, AMS Net ID, and Address.

Ex:

HMI IP: 192.168.1.15

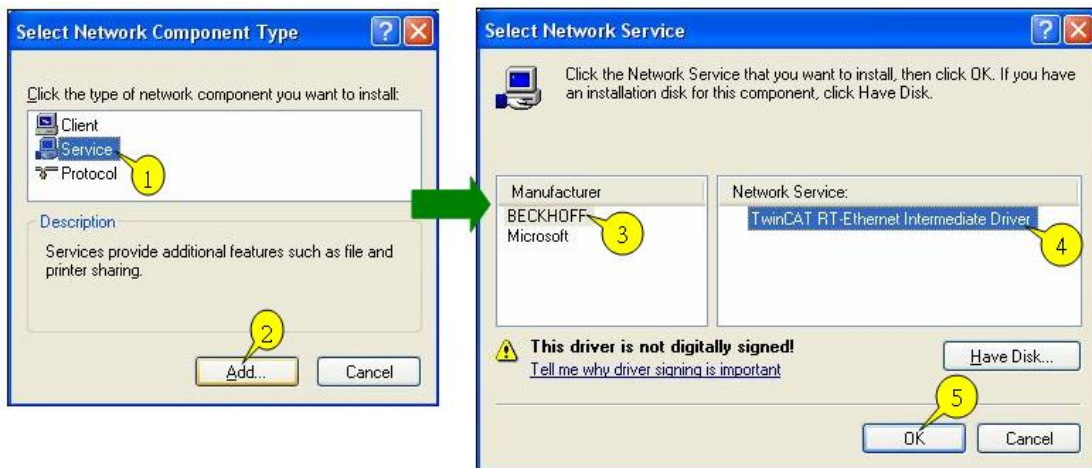
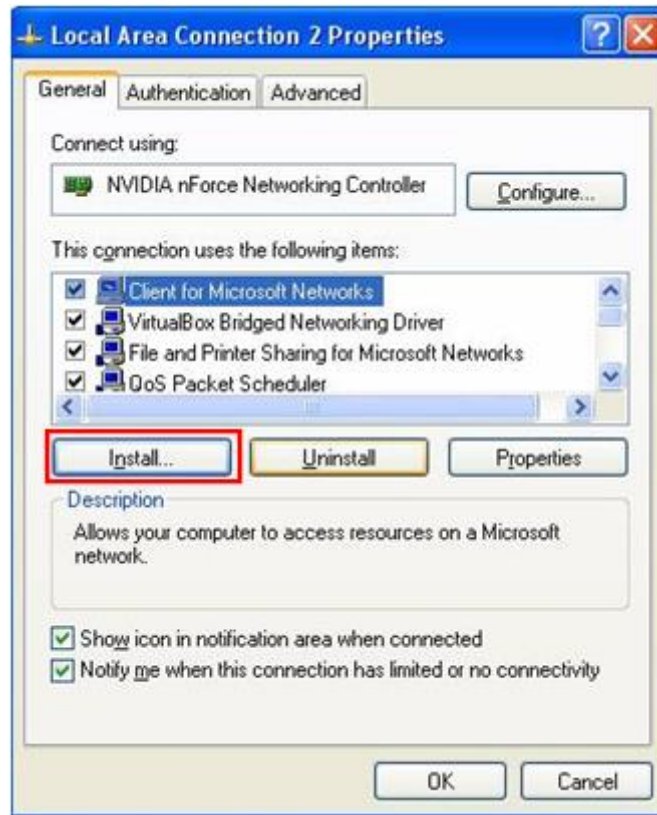
AMS Net ID: Must input 192.168.1.15.1.1

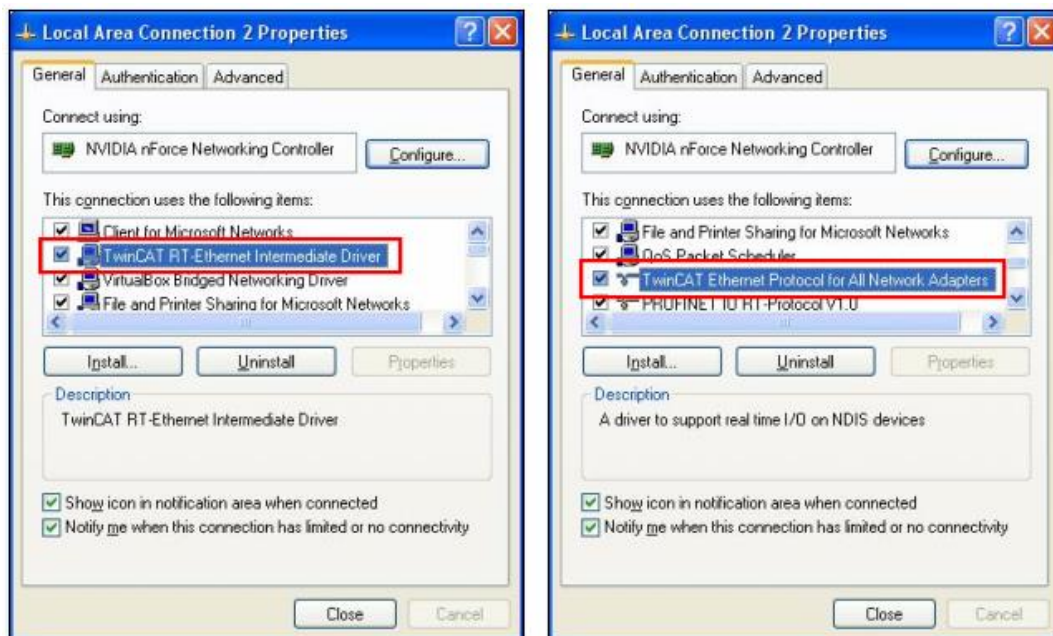
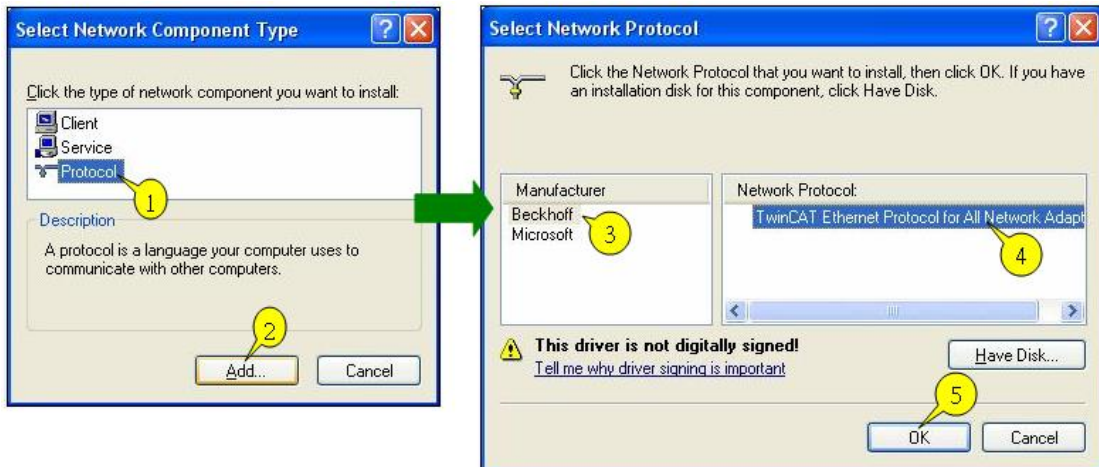
Address: 192.168.1.15

Name: Input "HMI" or any user-defined name.

Step2.

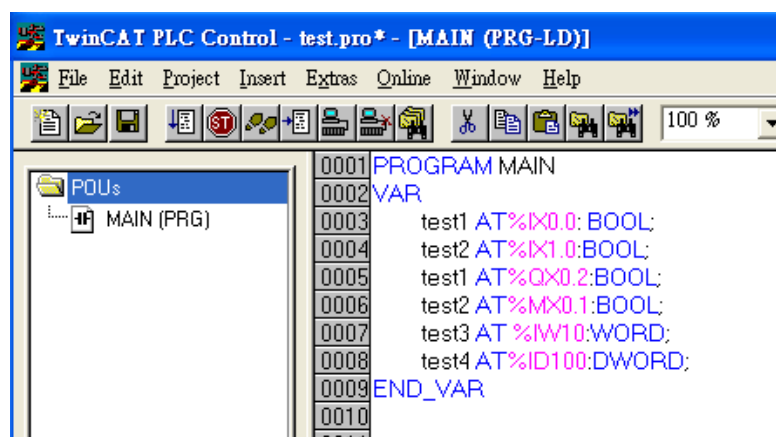
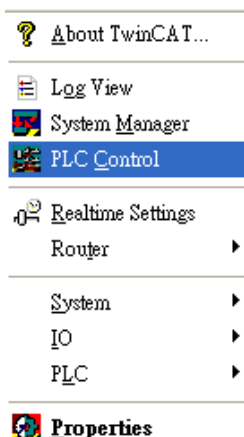
Simulate PLC on PC. 2 Twincat drivers must be installed as follows:





Step3.

The following commands can be utilized for Twincat PLC to output the parameters observed.



PS. TwinCAT PLC

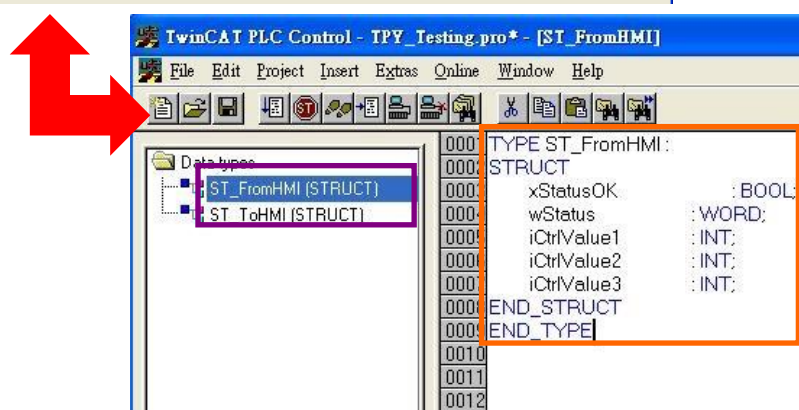
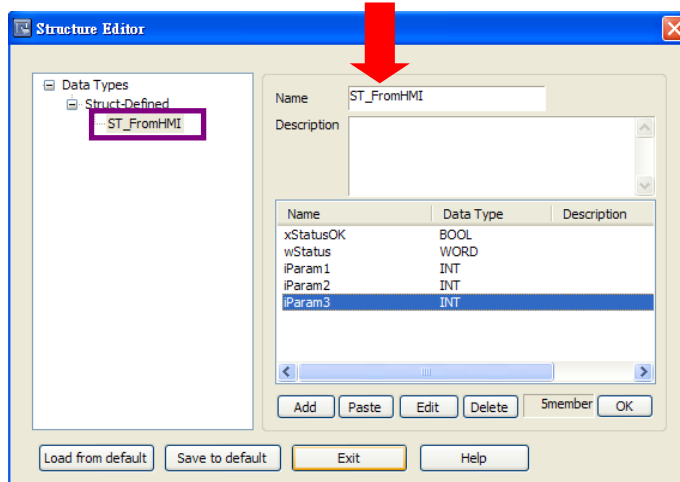
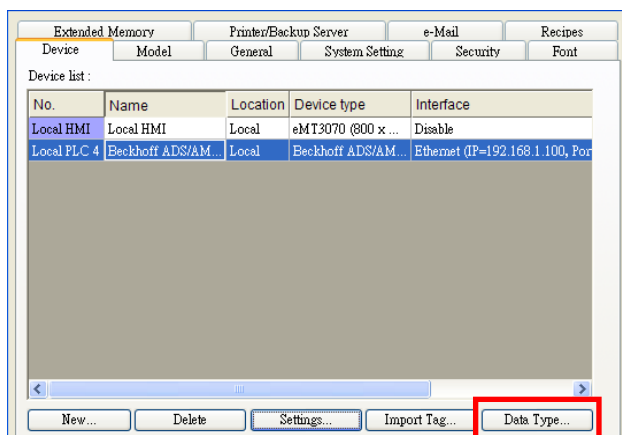
IX, QX, MX - Must output in BOOL type.

IW, QW, MW - Must output in UINT, WORD, and INT types.

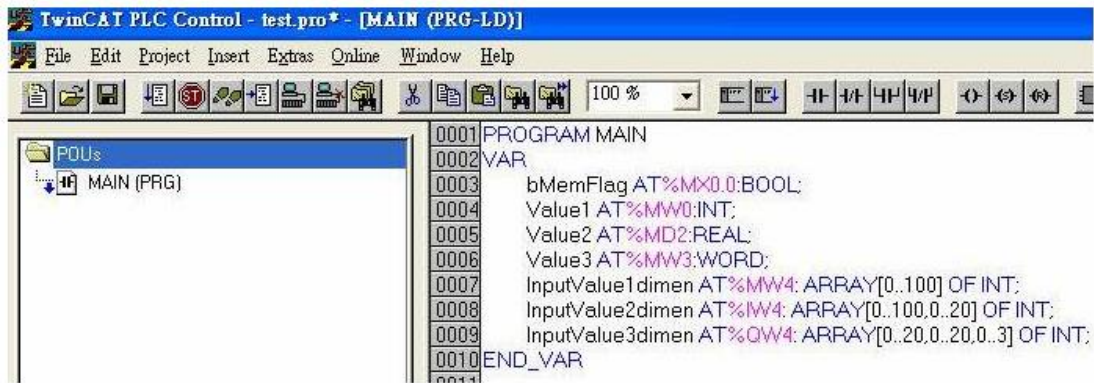
ID, QD, MD - Must output in UDINT, DWORD, and DINT types.

This driver supports variables under STRUCT structure. Click [Data Type] to open Structure Editor and create the same [Name] and [Data Type] as in TwinCAT PLC Control. The standard data types include:

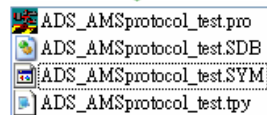
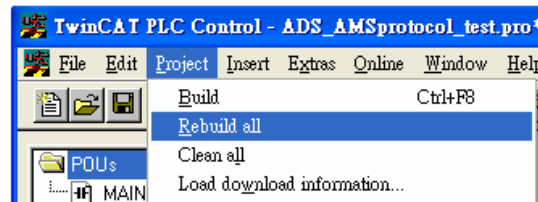
BOOL, WORD, INT, UINT, DINT, UDINT, REAL, DWORD, ARRAY



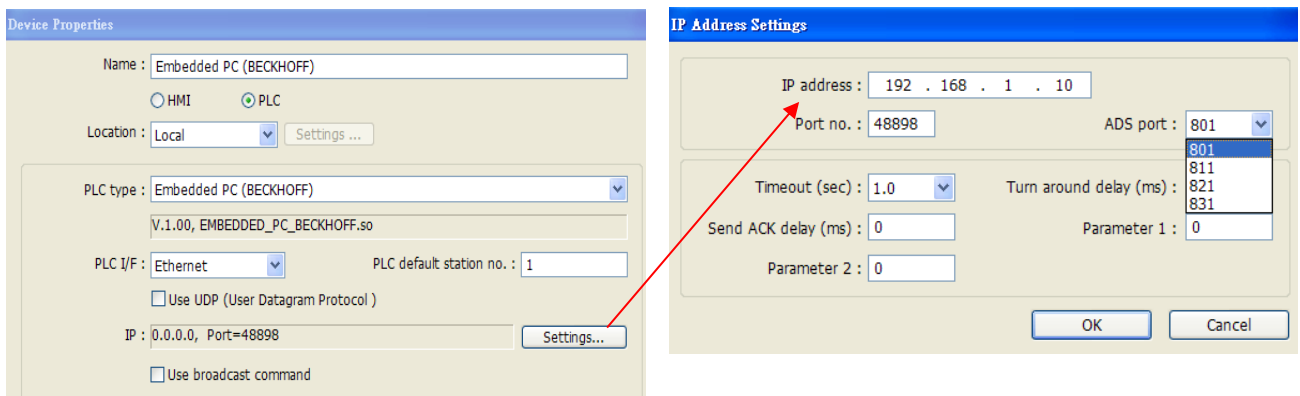
The syntax of Tag in TwinCAT software is: Tag Name +AT+%+Type, as shown in the following figure.



Project -> Rebuild all



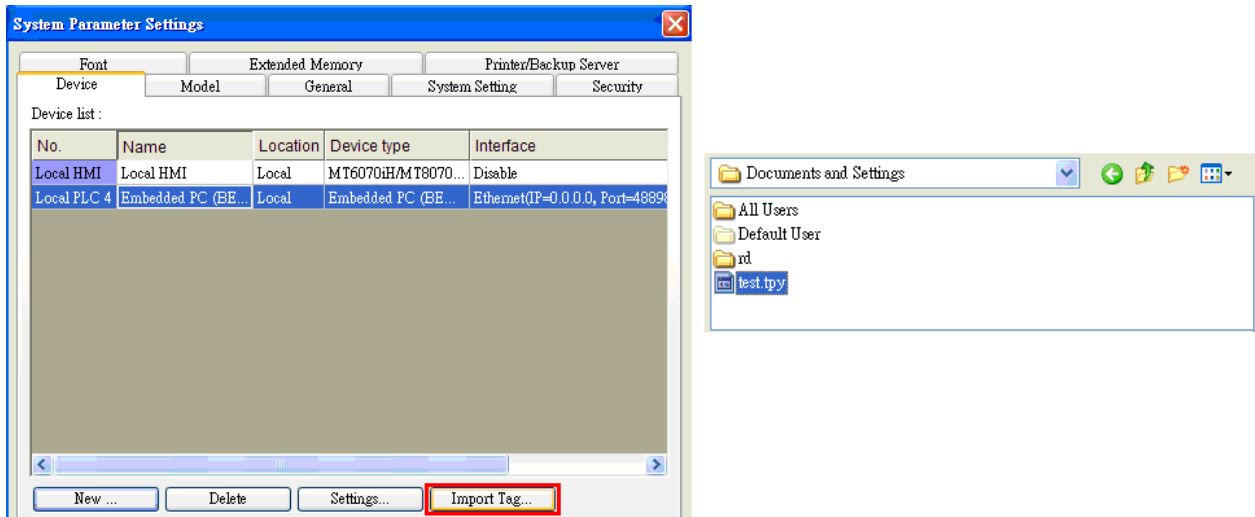
Step4. Set PLC IP in EasyBuilder.



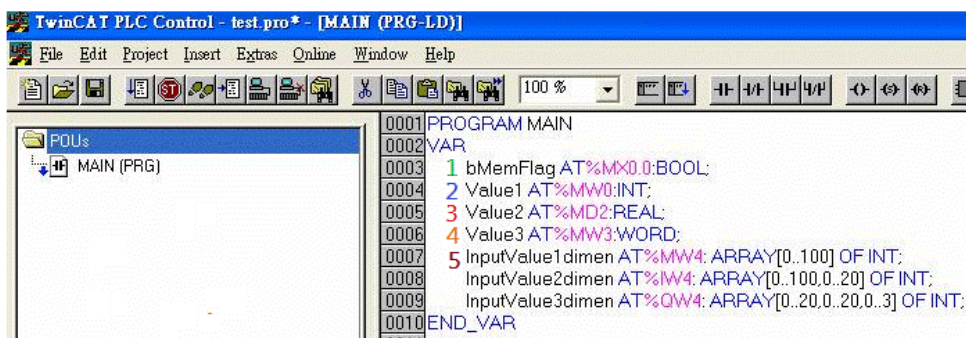
Step5.

Click [Import Tag] button in EasyBuilder to open the TPY file compiled by TwinCAT PLC Control.

Note: When using Beckhoff driver, if the TPY file cannot be imported, try download and install MSXML 4.0 in Microsoft - Download Center.



Import tpy to EasyBuilder, the result is shown in the following figure.

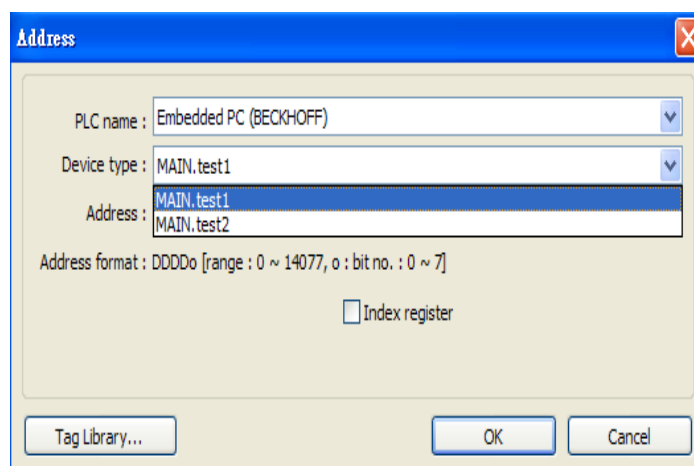
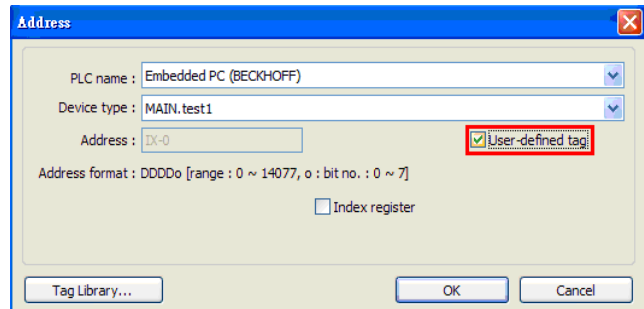
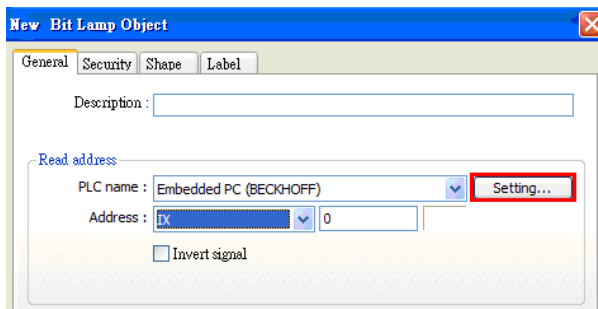
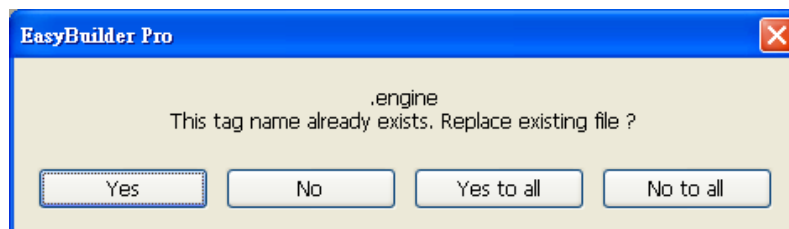
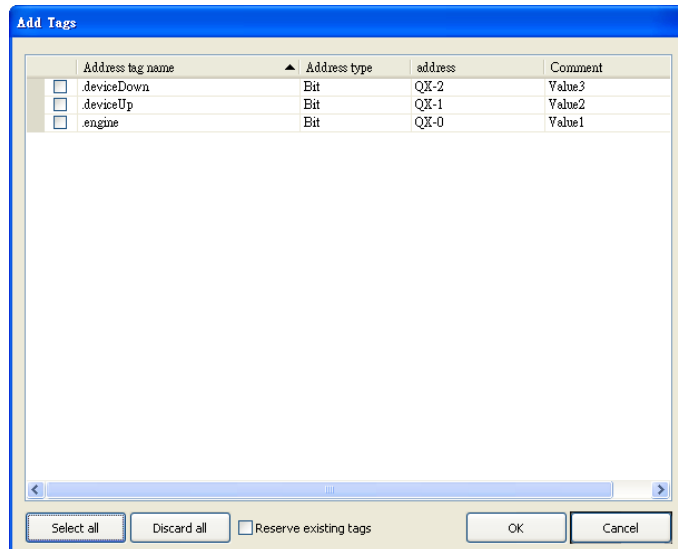


No.	Address tag name	PLC name	Addr...	Address	Read/W...
1	MAIN.bMemFlag	Beckhoff ADS/AMS (...)	Bit	MX-0 1	Read/...
2	MAIN.Value1	Beckhoff ADS/AMS (...)	Word	MW-0 2	Read/...
3	MAIN.Value2	Beckhoff ADS/AMS (...)	Word	MD-2 3	Read/...
4	MAIN.Value3	Beckhoff ADS/AMS (...)	Word	MW-3 4	Read/...
5	MAIN.InputValue1dimen[0]	Beckhoff ADS/AMS (...)	Word	MW-4 5	Read/...
6	MAIN.InputValue1dimen[1]	Beckhoff ADS/AMS (...)	Word	MW-6	Read/...
7	MAIN.InputValue1dimen[2]	Beckhoff ADS/AMS (...)	Word	MW-8	Read/...
8	MAIN.InputValue1dimen[3]	Beckhoff ADS/AMS (...)	Word	MW-10	Read/...
9	MAIN.InputValue1dimen[4]	Beckhoff ADS/AMS (...)	Word	MW-12	Read/...
10	MAIN.InputValue1dimen[5]	Beckhoff ADS/AMS (...)	Word	MW-14	Read/...
11	MAIN.InputValue1dimen[6]	Beckhoff ADS/AMS (...)	Word	MW-16	Read/...
12	MAIN.InputValue1dimen[7]	Beckhoff ADS/AMS (...)	Word	MW-18	Read/...
13	MAIN.InputValue1dimen[8]	Beckhoff ADS/AMS (...)	Word	MW-20	Read/...
14	MAIN.InputValue1dimen[9]	Beckhoff ADS/AMS (...)	Word	MW-22	Read/...
15	MAIN.InputValue1dimen[10]	Beckhoff ADS/AMS (...)	Word	MW-24	Read/...
16	MAIN.InputValue1dimen[11]	Beckhoff ADS/AMS (...)	Word	MW-26	Read/...
17	MAIN.InputValue1dimen[12]	Beckhoff ADS/AMS (...)	Word	MW-28	Read/...
18	MAIN.InputValue1dimen[13]	Beckhoff ADS/AMS (...)	Word	MW-30	Read/...

Step6.

The following dialog box appears for users to select all or part of the data to import. A reminding message is shown when import the same data repeatedly.

*EasyBuilder8000 does not support [Comment] setting.



Step7.

Download the project compiled in EasyBuilder to HMI.

Device address:

Bit/Wor	Device type	Format	Range	Memo
B	IX	DDDDDo	0 ~ 655357	o : Bit no.(0 ~ 7)
B	QX	DDDDDo	0 ~ 655357	o : Bit no.(0 ~ 7)
B	MX	DDDDDo	0 ~ 655357	o : Bit no.(0 ~ 7)
W	IW	DDDDD	0 ~ 65535	
W	QW	DDDDD	0 ~ 65535	
W	MW	DDDDD	0 ~ 65535	
DW	ID	DDDDD	0 ~ 65535	
DW	QD	DDDDD	0 ~ 65535	
DW	MD	DDDDD	0 ~ 65535	

Support Device Type:

Data type	EasyBuilder data format	Memo
Bool	bit	
Word	16-bit BCD, Hex, Binary, Unsigned	16-bit
Int	16-bit BCD, Hex, Binary, Signed	16-bit
UInt	16-bit BCD, Hex, Binary, Unsigned	16-bit
DWord	32-bit BCD, Hex, Binary, Unsigned	32-bit
DInt	32-bit BCD, Hex, Binary, Signed	32-bit
Real	32-bit Float	32-bit
UDInt	32-bit BCD, Hex, Binary, Unsigned	32-bit
String	ASCII input and ASCII display	

Wiring Diagram:

Ethernet cable:



Beckhoff Embedded PC

Supported Series: Intel-CX10x0, CX50x0 and Twincat

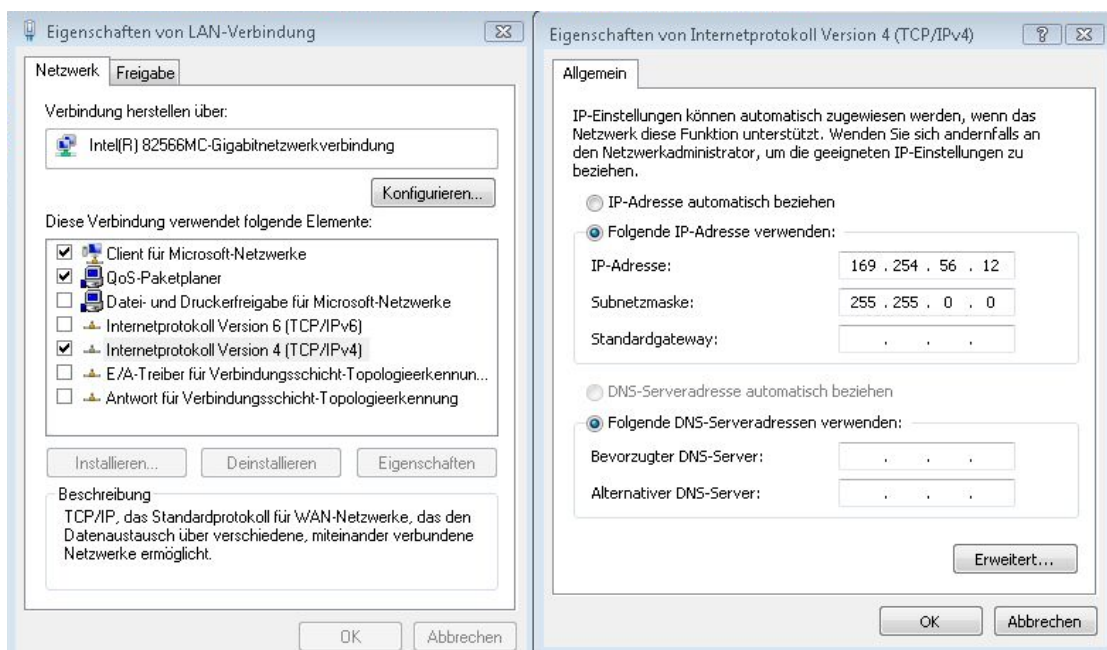
HMI Setting:

Parameters	Recommended	Options	Notes
PLC type	Beckhoff Embedded PC		
PLC I/F	Ethernet		
Port no.	48898		
ADS port	801	801, 811, 821, 831	
PLC sta. no.	1		

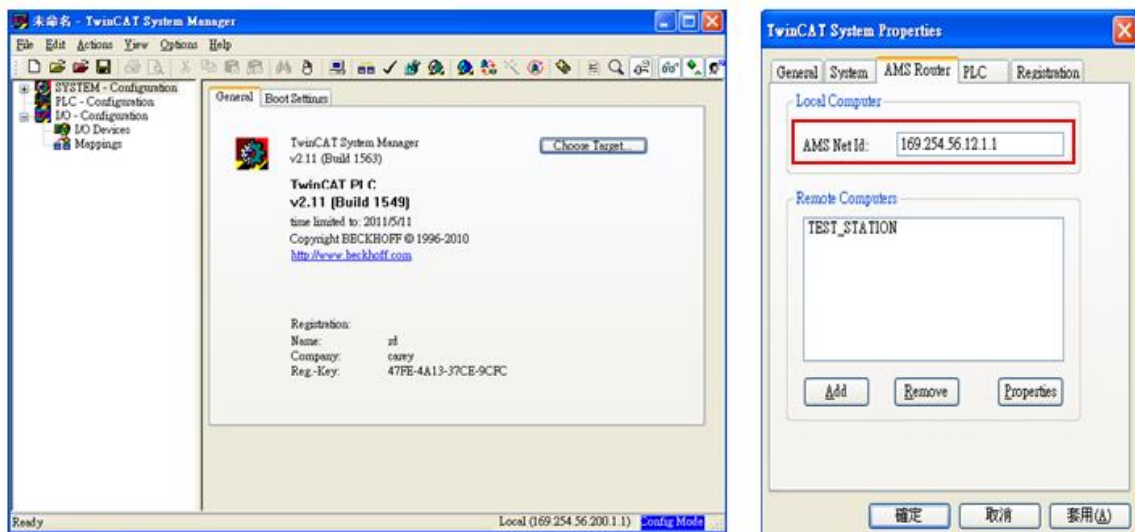
PLC Setting:

For Twincat:

- a. Confirm PC IP address

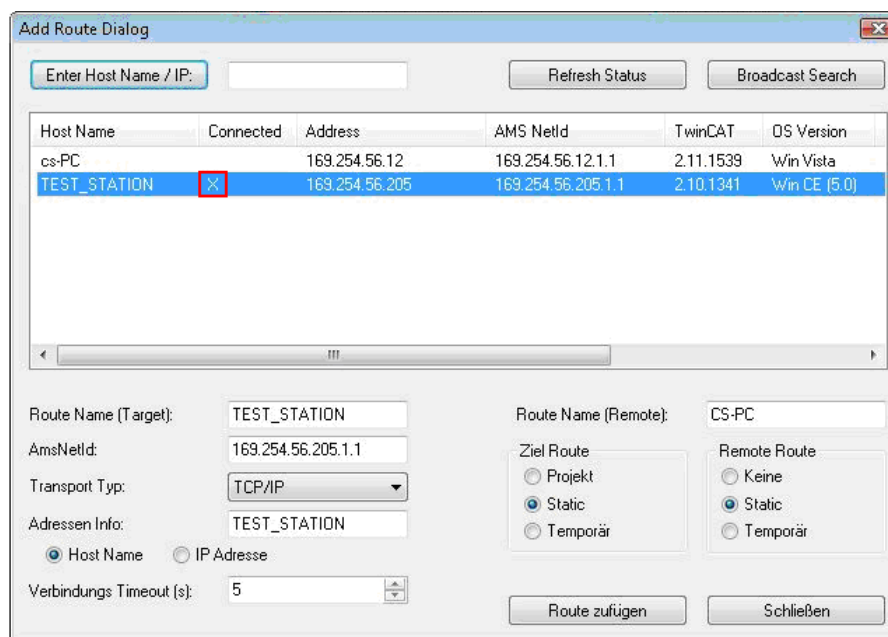


b. Open Twincat, Set IP address 169.254.56.12.1.1

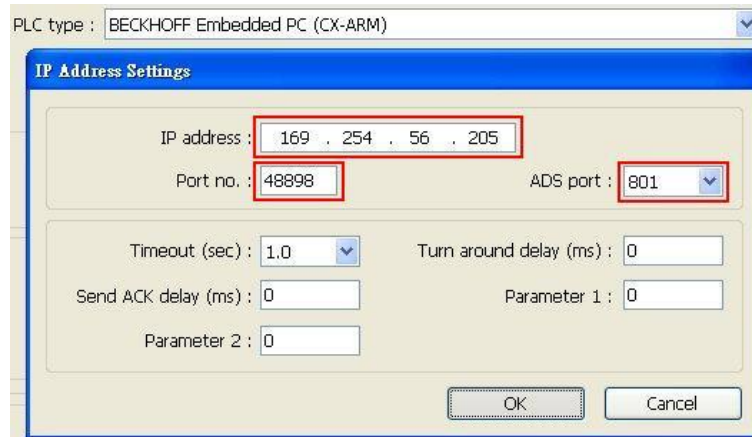


c. Use Twincat to build a Route Table to make sure the system is connected, if PLC power turns OFF and then ON, please redo this step.

Note: when connected, if “X” is displayed, the connection succeeded.



d. Open EasyBuilder, set IP address, ADS port and Port no.

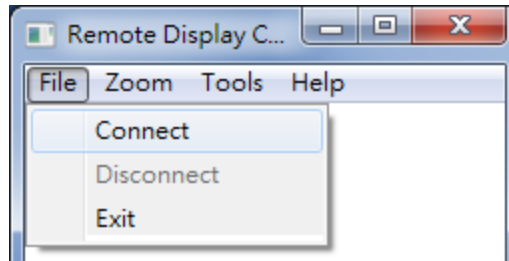


e. Run on line simulation.

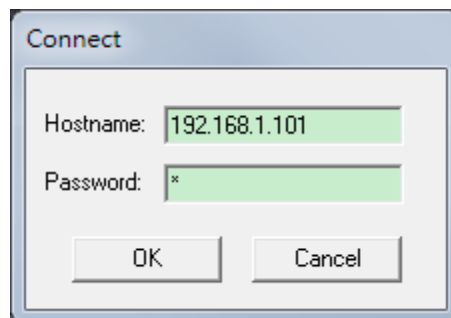
Note: If the project is downloaded to HMI, please set HMI IP 169.254.56.12 identically to Twincat IP address setting.

For CERHOST:

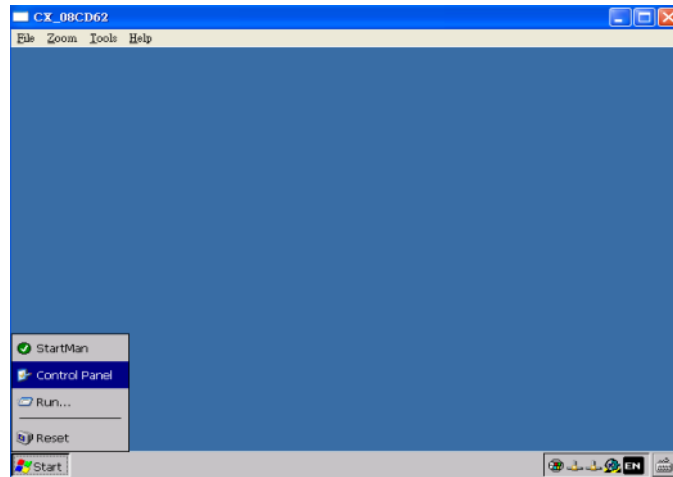
a. Execute CERHOST.exe to connect with PLC on PC.



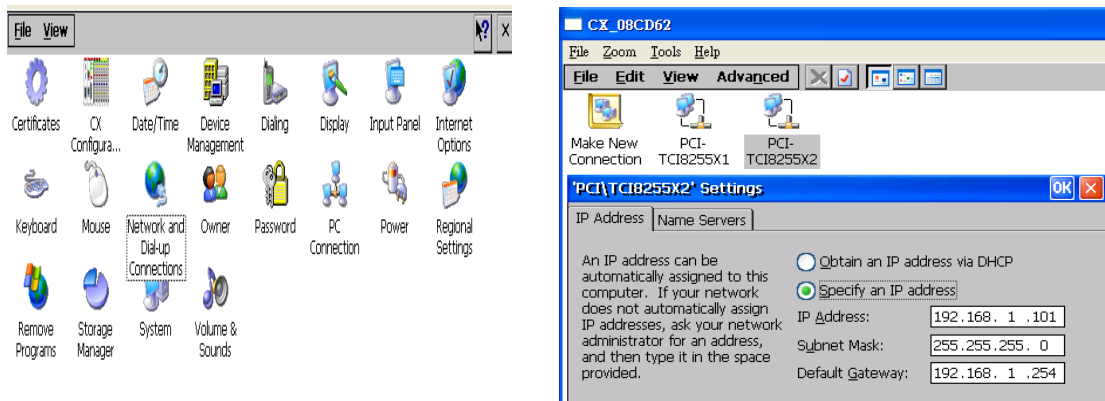
b. Enter PLC IP and Password (default password: 1).



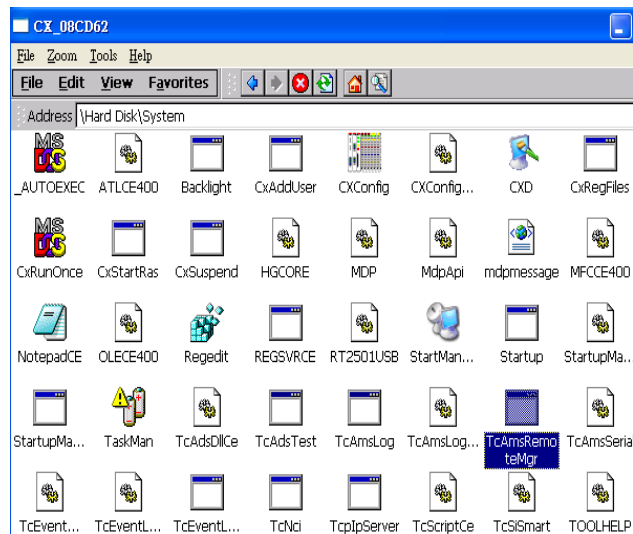
c. Succeeded to connect with PLC, click Start -> click Control Panel.



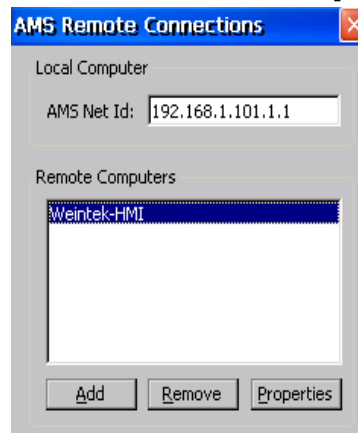
d. Click [Network and Dial-Up Connections] to display PLC device information; select the PLC to check its IP.



e. Access PLC system settings, the default directory: \Hard Disk\System, execute [TcAmsRemoteMgr].



f. AMS Net Id consists of 6 numbers, separated by “.”. The first 4 numbers stand for IP and followed by “1.1”. The figure below shows the AMS Net Id of Local Computer, please enter PLC IP plus “1.1”. Remote Computers shows the information of the HMI to connect with. Click [Add] to add the HMI and click [OK] to finish setting.



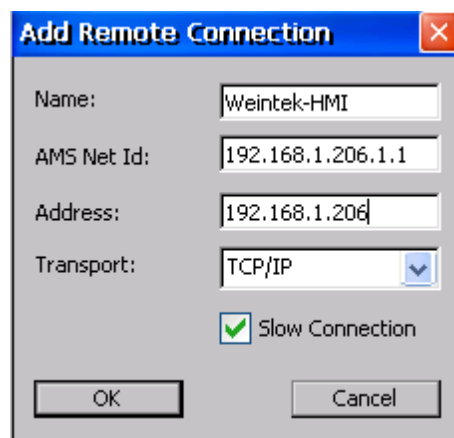
g. Name: Device name.

AMS Net Id: The IP followed by “1.1” of the device to connect with.

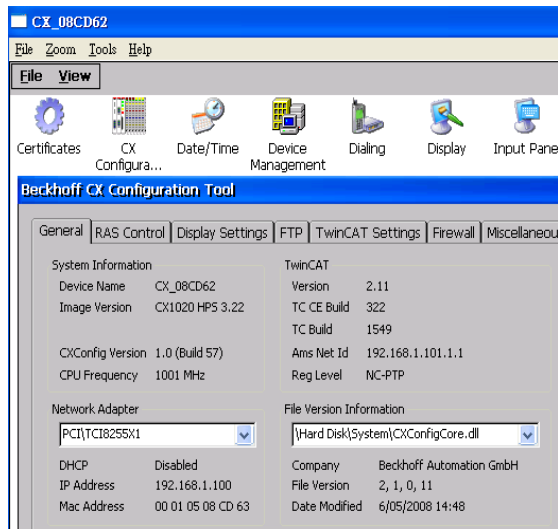
Address: The IP address of the device to connect with.

Transport: The way of connection.

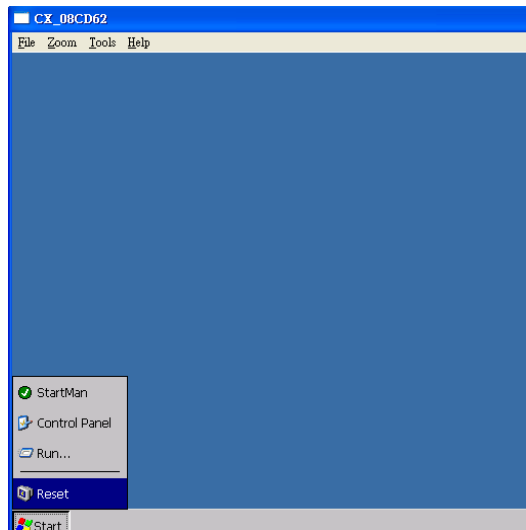
Slow Connection: As shown in the figure below.



h. Return to Control Panel; execute CX Configuration Tool to confirm PLC AMS Net Id.



i. Confirm settings and click Start -> Reset PLC.

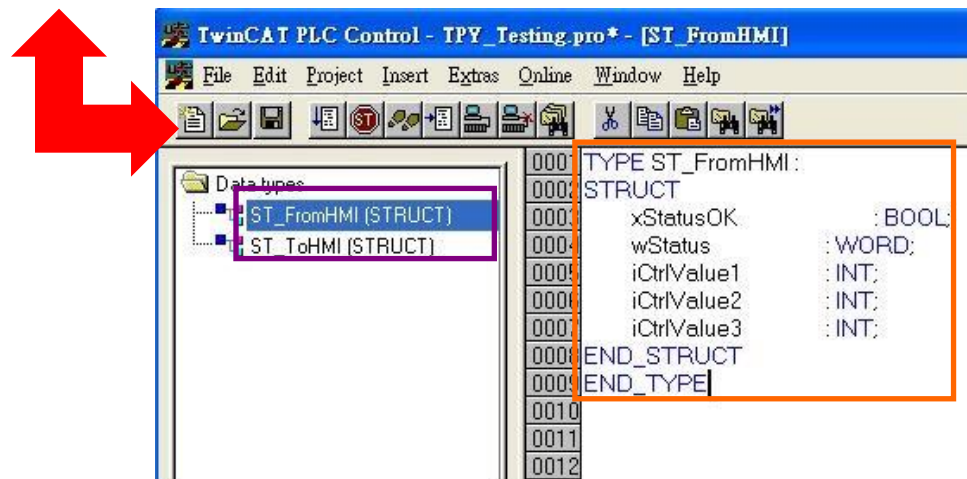
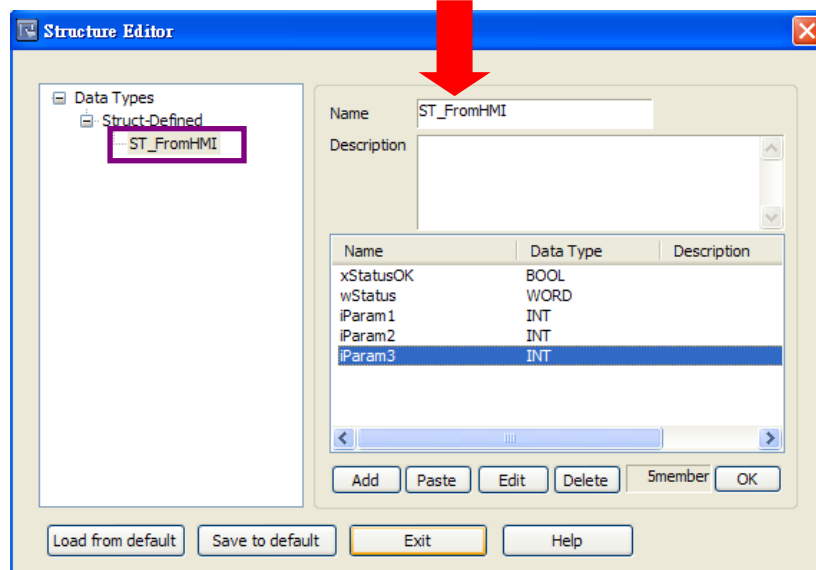
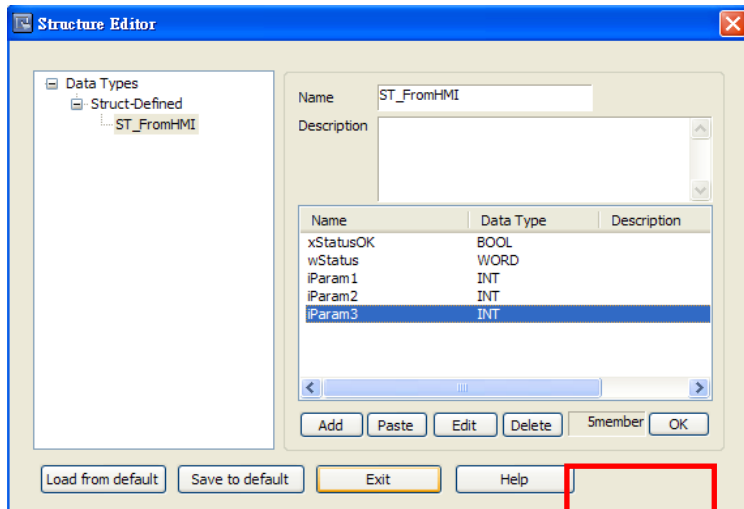


Building Data Structure :

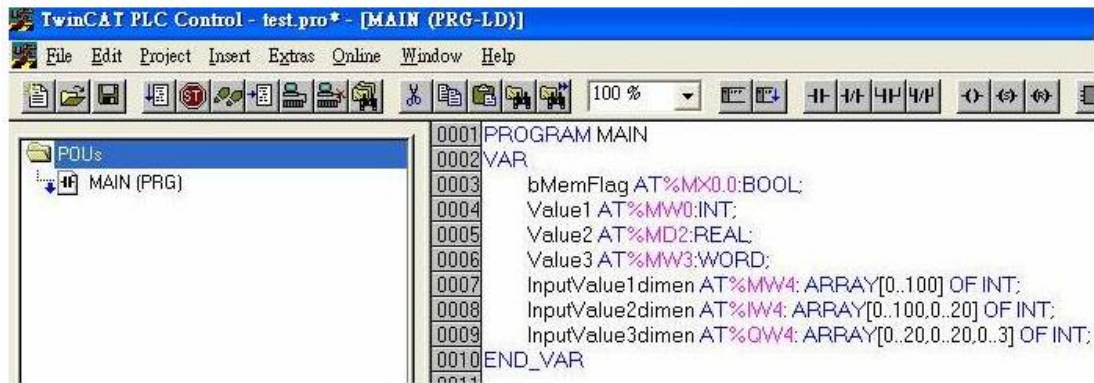
Step1. This driver supports variables under STRUCT structure. Click [Data Type] to open Structure Editor and create the same [Name] and [Data Type] as in Twincat PLC Control.

The standard data types include:

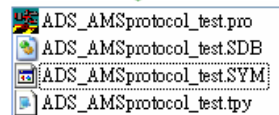
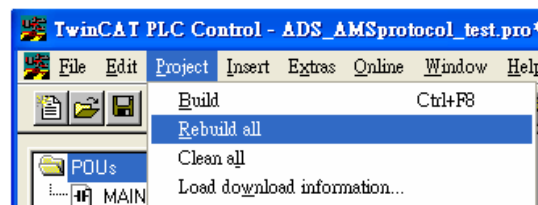
BOOL, WORD, INT, UINT, DINT, UDINT, REAL, DWORD, ARRAY



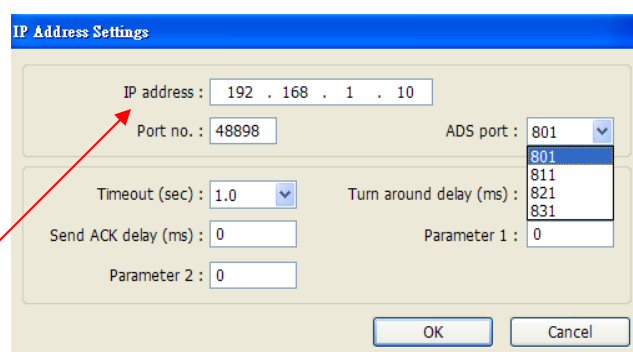
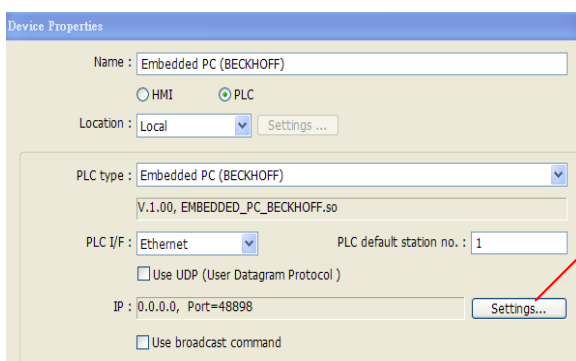
The syntax of Tag in TwinCAT software is: Tag Name +AT+%+Type, as shown in the following figure.



Step2.Project → Rebuild all



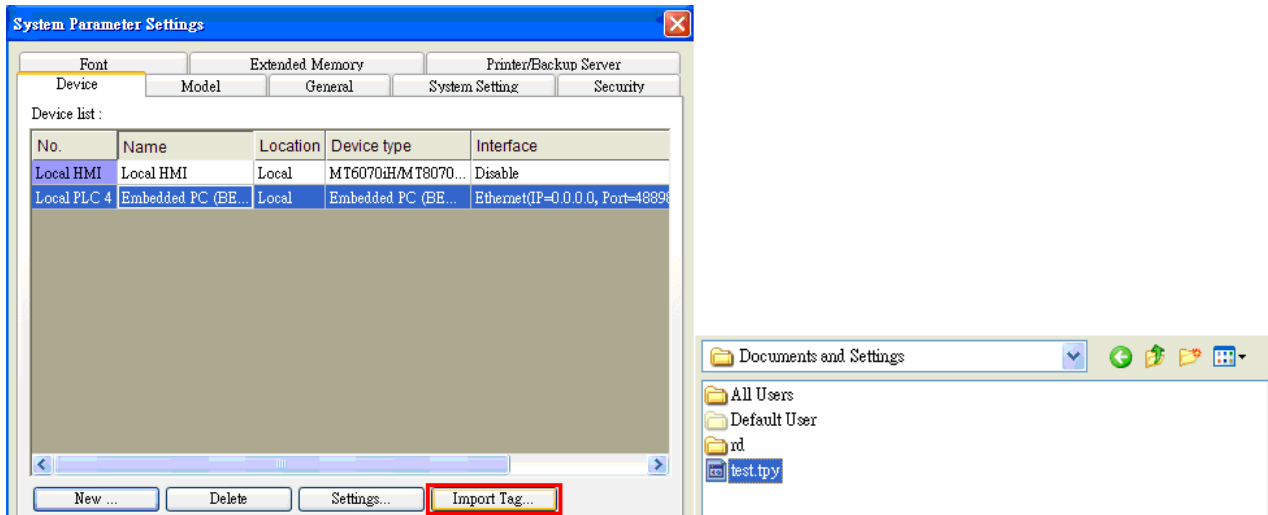
Step3. Set PLC IP in EasyBuilder.



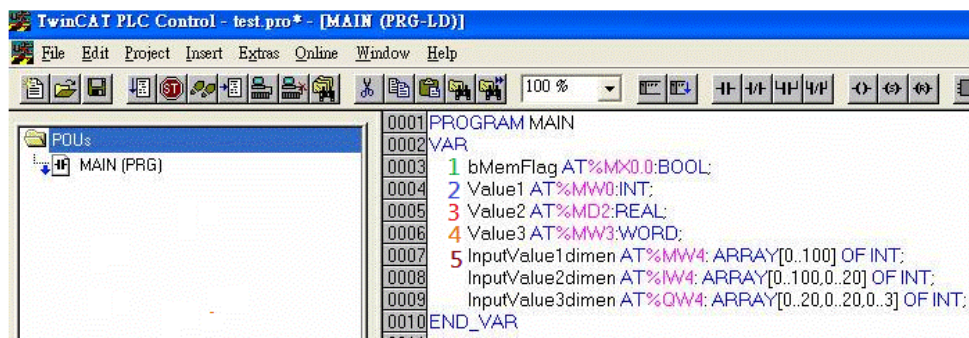
Step4.

Click [Import Tag] button in EasyBuilder to open the TPY file compiled by TwinCAT PLC Control.

Note: When using Beckhoff driver, if the TPY file cannot be imported, try download and install MSXML 4.0 in Microsoft - Download Center.



Import tpy to EasyBuilder, the result is shown in the following figure.

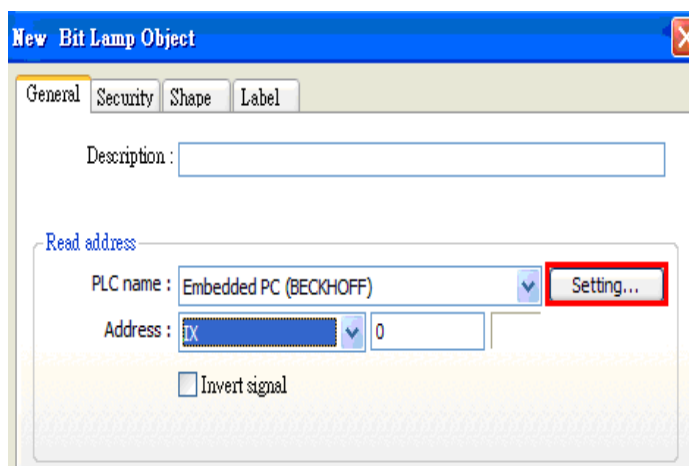
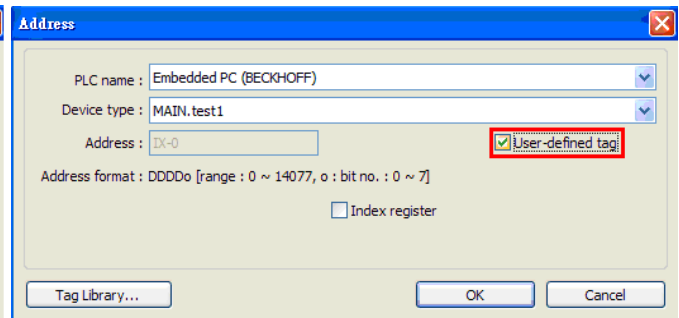
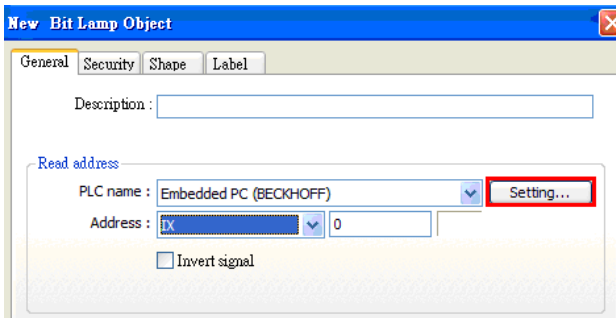
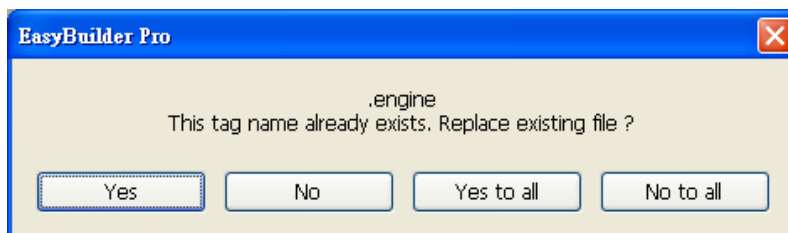
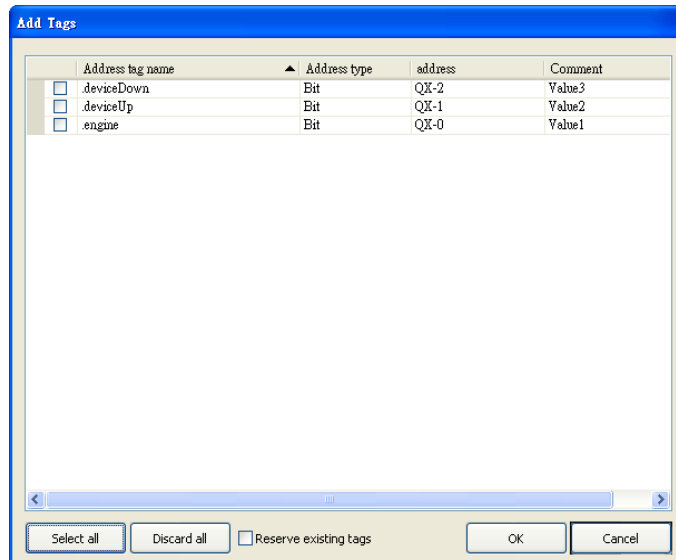


No.	Address tag name	PLC name	Address	Read/W...
1	MAIN.bMemFlag	Beckhoff ADS/AMS (...)	Bit MX-0 1	Read/...
2	MAIN.Value1	Beckhoff ADS/AMS (...)	Word MW-0 2	Read/...
3	MAIN.Value2	Beckhoff ADS/AMS (...)	Word MD-2 3	Read/...
4	MAIN.Value3	Beckhoff ADS/AMS (...)	Word MW-3 4	Read/...
5	MAIN.InputValue1dimen[0]	Beckhoff ADS/AMS (...)	Word MW-4 5	Read/...
6	MAIN.InputValue1dimen[1]	Beckhoff ADS/AMS (...)	Word MW-6	Read/...
7	MAIN.InputValue1dimen[2]	Beckhoff ADS/AMS (...)	Word MW-8	Read/...
8	MAIN.InputValue1dimen[3]	Beckhoff ADS/AMS (...)	Word MW-10	Read/...
9	MAIN.InputValue1dimen[4]	Beckhoff ADS/AMS (...)	Word MW-12	Read/...
10	MAIN.InputValue1dimen[5]	Beckhoff ADS/AMS (...)	Word MW-14	Read/...
11	MAIN.InputValue1dimen[6]	Beckhoff ADS/AMS (...)	Word MW-16	Read/...
12	MAIN.InputValue1dimen[7]	Beckhoff ADS/AMS (...)	Word MW-18	Read/...
13	MAIN.InputValue1dimen[8]	Beckhoff ADS/AMS (...)	Word MW-20	Read/...
14	MAIN.InputValue1dimen[9]	Beckhoff ADS/AMS (...)	Word MW-22	Read/...
15	MAIN.InputValue1dimen[10]	Beckhoff ADS/AMS (...)	Word MW-24	Read/...
16	MAIN.InputValue1dimen[11]	Beckhoff ADS/AMS (...)	Word MW-26	Read/...
17	MAIN.InputValue1dimen[12]	Beckhoff ADS/AMS (...)	Word MW-28	Read/...
18	MAIN.InputValue1dimen[13]	Beckhoff ADS/AMS (...)	Word MW-30	Read/...

Step5.

The following dialog box appears for users to select all or part of the data to import. A reminding message is shown when import the same data repeatedly.

*EasyBuilder8000 does not support [Comment] setting.



Step6.

Download the project compiled in EasyBuilder to HMI.

Device address:

Bit/Wor	Device type	Format	Range	Memo
B	IX	DDDDDo	0 ~ 655357	o : Bit no.(0 ~ 7)
B	QX	DDDDDo	0 ~ 655357	o : Bit no.(0 ~ 7)
B	MX	DDDDDo	0 ~ 655357	o : Bit no.(0 ~ 7)
W	IW	DDDDD	0 ~ 65535	
W	QW	DDDDD	0 ~ 65535	
W	MW	DDDDD	0 ~ 65535	
DW	ID	DDDDD	0 ~ 65535	
DW	QD	DDDDD	0 ~ 65535	
DW	MD	DDDDD	0 ~ 65535	

Support Device Type:

Data Type	EasyBuilder data format	Memo
Bool	bit	
Word	16-bit BCD, Hex, Binary, Unsigned	16-bit
Int	16-bit BCD, Hex, Binary, Signed	16-bit
UInt	16-bit BCD, Hex, Binary, Unsigned	16-bit
DWord	32-bit BCD, Hex, Binary, Unsigned	32-bit
DInt	32-bit BCD, Hex, Binary, Signed	32-bit
Real	32-bit Float	32-bit
UDInt	32-bit BCD, Hex, Binary, Unsigned	32-bit
String	ASCII input and ASCII display	

Wiring Diagram:

Ethernet cable:



Beckhoff TwinCAT 3 ADS/AMS (Ethernet)

Supported Series:

CX8000, CX90x0, CX1010, CP62xx, CX5010, CP62xx, CX1020, CX2020, CPxxxx, C6920, CX2030, CPxxxx, CP6930, CX2040, C65xx, C69xx.

Website: <http://infosys.beckhoff.com/>

HMI Setting:

Parameters	Recommended	Options	Notes
PLC type	Beckhoff TwinCAT 3 ADS/AMS (Ethernet)		
PLC I/F	Ethernet		
Port no.	48898		
ADS port	801	300,800,801,811,821,831,851,852,853,854	

Device Address:

Bit/Word	Device	Format	Range	Memo
B	IX	DDDDDDdd	0 ~ 6553515	*Note
B	QX	DDDDDDdd	0 ~ 6553515	*Note
B	MX	DDDDDDdd	0 ~ 6553515	
B	IX_Bit	DDDDDDo	0 ~ 65537	*Note
B	QX_Bit	DDDDDDo	0 ~ 65537	*Note
B	MX_Bit	DDDDDDo	0 ~ 65537	
W	IW	OOOOOO	0 ~ 65535	*Note
W	QW	DDDDDD	0 ~ 65535	*Note
W	MW	DDDDDD	0 ~ 65535	
W	ID	DDDDDD	0 ~ 65535	*Note
W	QD	DDDDDD	0 ~ 65535	*Note
W	MD	DDDDDD	0 ~ 65535	

Note: The I addresses and Q addresses are mapped to M addresses. To use I addresses or Q addresses, please use Beckhoff TwinCAT PLC (Ethernet) – Free Tag Names driver instead.

Wiring Diagram:

Ethernet cable:



Beckhoff TwinCAT PLC (Ethernet) – Free Tag

Names

Supported Series:

CX8000, CX90x0, CX1010, CP62xx, CX5010, CP62xx, CX1020, CX2020, CPxxxx, C6920, CX2030, CPxxxx, CP6930, CX2040, C65xx, C69xx.

Website: <http://infosys.beckhoff.com/>

HMI Setting:

Parameters	Recommended	Options	Notes
PLC type	Beckhoff TwinCAT PLC (Ethernet) – Free Tag Names		
PLC I/F	Ethernet		
Port no.	48898		
PLC sta. no.	No need to set station no.		

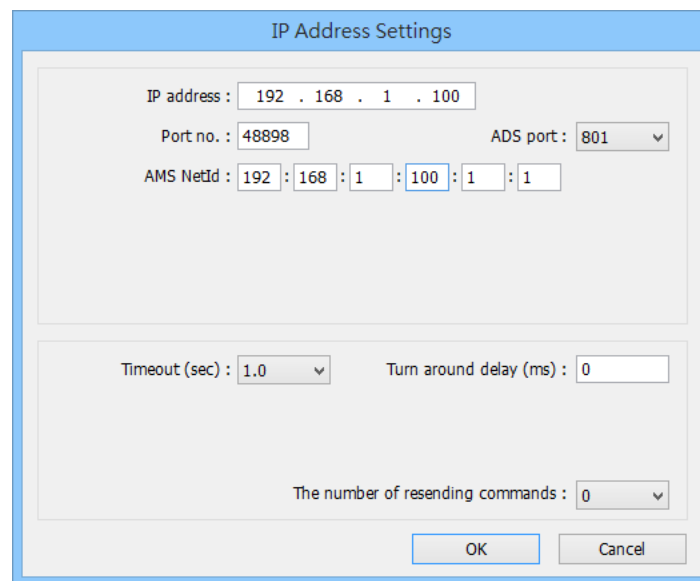
Support Device Type:

Data Type	EasyBuilder data format	Memo
Bool	bit	
Word	16-bit BCD, Hex, Binary, Unsigned	16-bit
Int	16-bit BCD, Hex, Binary, Signed	16-bit
UInt	16-bit BCD, Hex, Binary, Unsigned	16-bit
DWord	32-bit BCD, Hex, Binary, Unsigned	32-bit
DInt	32-bit BCD, Hex, Binary, Signed	32-bit
Real	32-bit Float	32-bit
UDInt	32-bit BCD, Hex, Binary, Unsigned	32-bit
String	ASCII input and ASCII display	

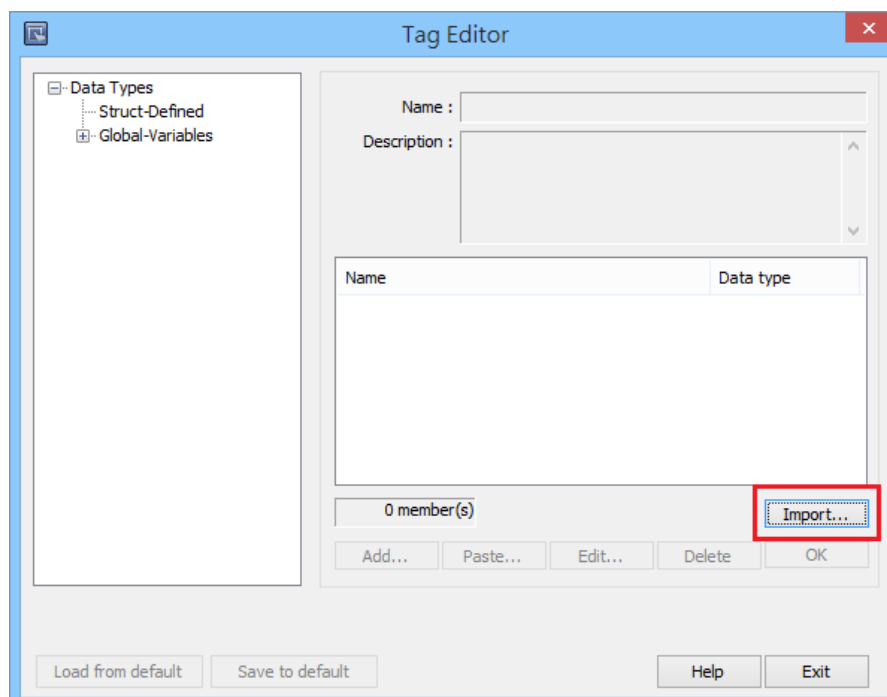
How to Import Tags:

The files generated after compilation in TwinCAT2 and TwinCAT3 programming software can be directly imported to EasyBuilder. The following steps explain how to import address tags.

1. Go to System Parameter Settings and add “Beckhoff TwinCAT PLC (Ethernet) – Free Tag Names” to the device list. Click [Settings] and configure the PLC parameters.



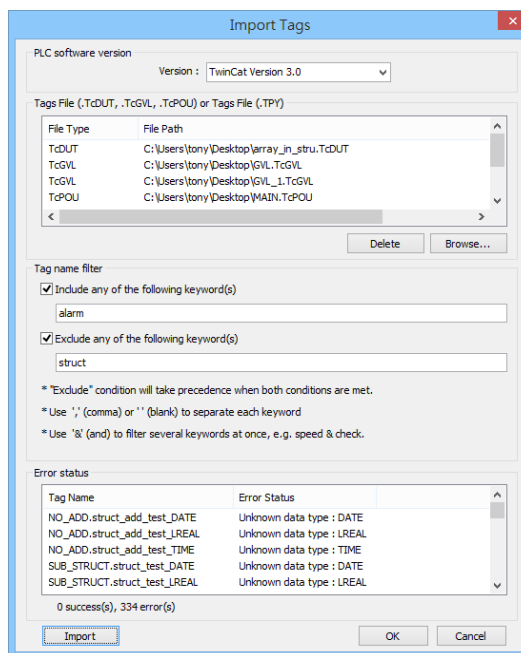
2. Go to System Parameter Settings » Tag Editor and click [Import].



3. Select PLC Software Version. The standard file type of TwinCAT 2.0 is .typ. The standard file types of TwinCAT 3.0 are: .TcDUT, .TcGVL, and .TcPOU. The tags to be imported can be selected by a tag name filter. Select the file type and then click [Import]. The invalid address types will be displayed in Error Status field. Click [OK] to leave.

Note1. Tag name can not include “.”.

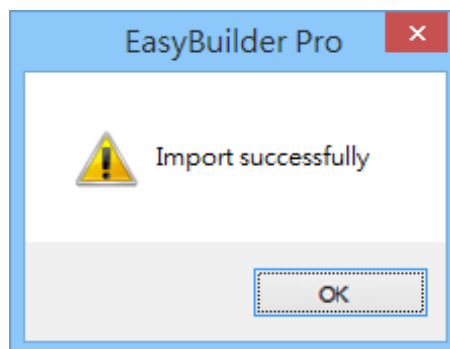
Note2. GVL files with Tc2GvlVarNames attribute are not supported.



```

1 {attribute Tc2GvlVarNames'}
2
3 VAR_GLOBAL      Not Supported
4     nVar: INT;
5 END_VAR
6
    
```

4. The “Import successfully” message will be shown upon completion.



Wiring Diagram:

Ethernet cable:



Bosch Rexroth

HMI Setting:

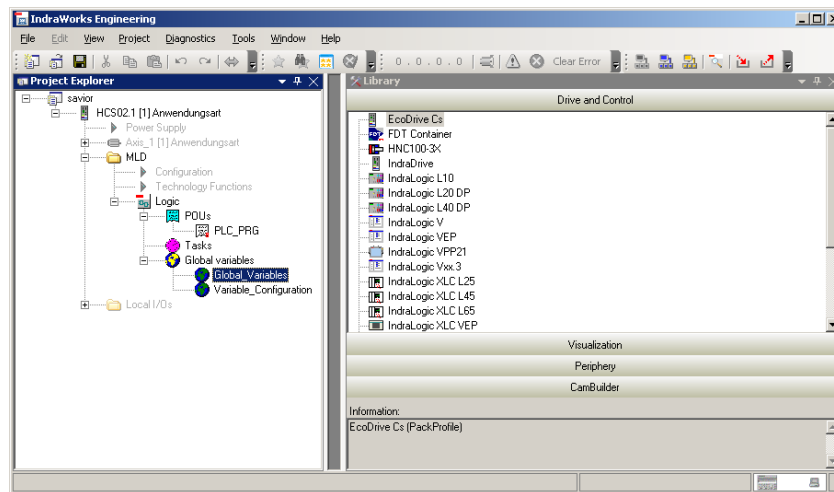
Parameters	Recommended	Options	Notes
PLC type	Bosch Rexroth		
PLC I/F	RS232		
Baud rate	115200		
Data bits	8		
Parity	None		
Stop bits	1		
PLC sta. no.	1		

Support Device Type:

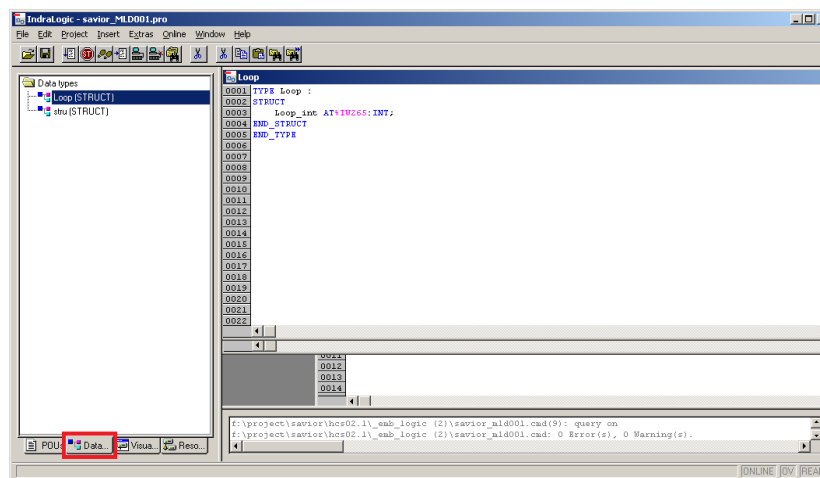
Data type	EasyBuilder data format	Memo
Bool	bit	
Byte	16-bit BCD, Hex, Binary, Unsigned	8-bit
SInt	16-bit BCD, Hex, Binary, Signed	8-bit
USInt	16-bit BCD, Hex, Binary, Unsigned	8-bit
Word	16-bit BCD, Hex, Binary, Unsigned	16-bit
Int	16-bit BCD, Hex, Binary, Signed	16-bit
UInt	16-bit BCD, Hex, Binary, Unsigned	16-bit
DWord	32-bit BCD, Hex, Binary, Unsigned	32-bit
DInt	32-bit BCD, Hex, Binary, Signed	32-bit
Real	32-bit Float	32-bit
UDInt	32-bit BCD, Hex, Binary, Unsigned	32-bit

Import Tag:

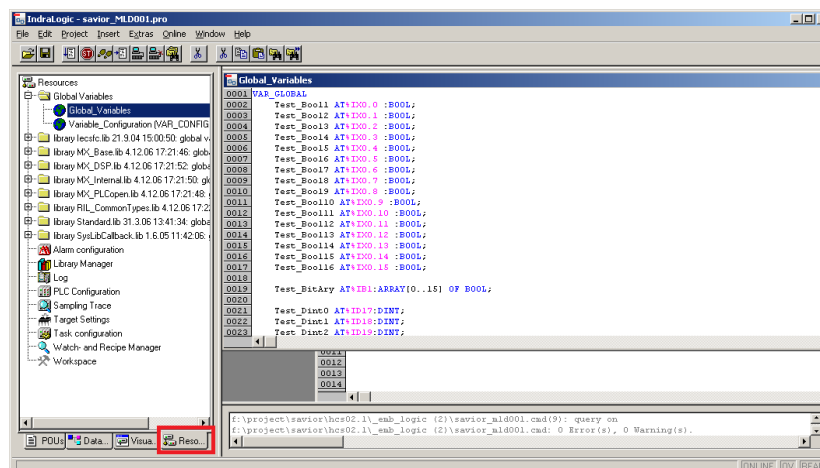
1. Launch IndraWorks PLC software, click **[Global_Variables]**, and edit the project.



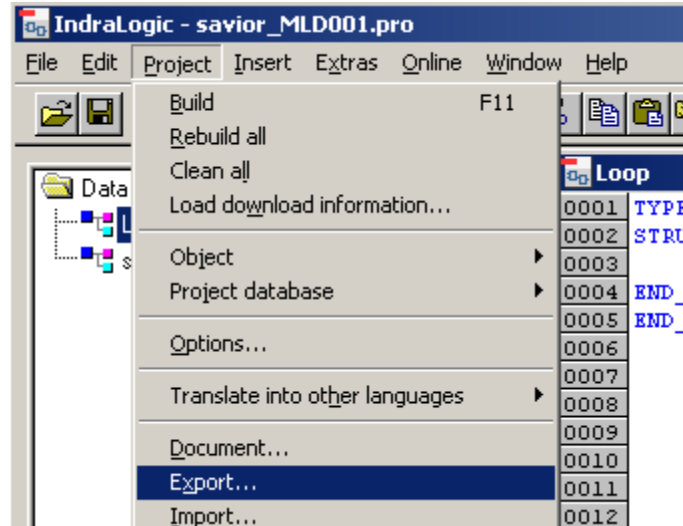
2. Struct can be edited in **[Data types]** tab, and Global_variables can be edited in **[Resources]** tab.
[Data types]



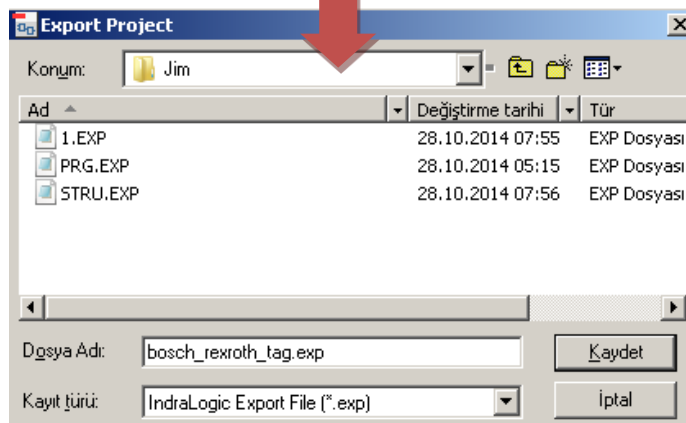
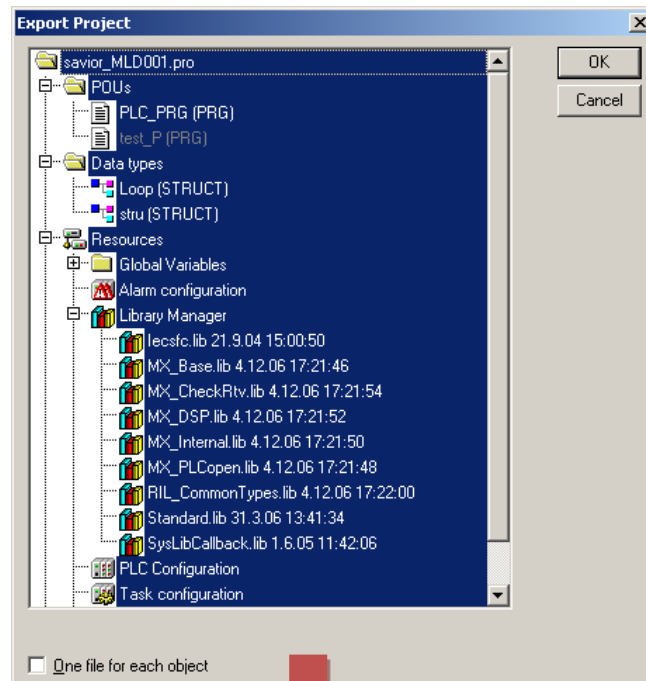
[Resources]



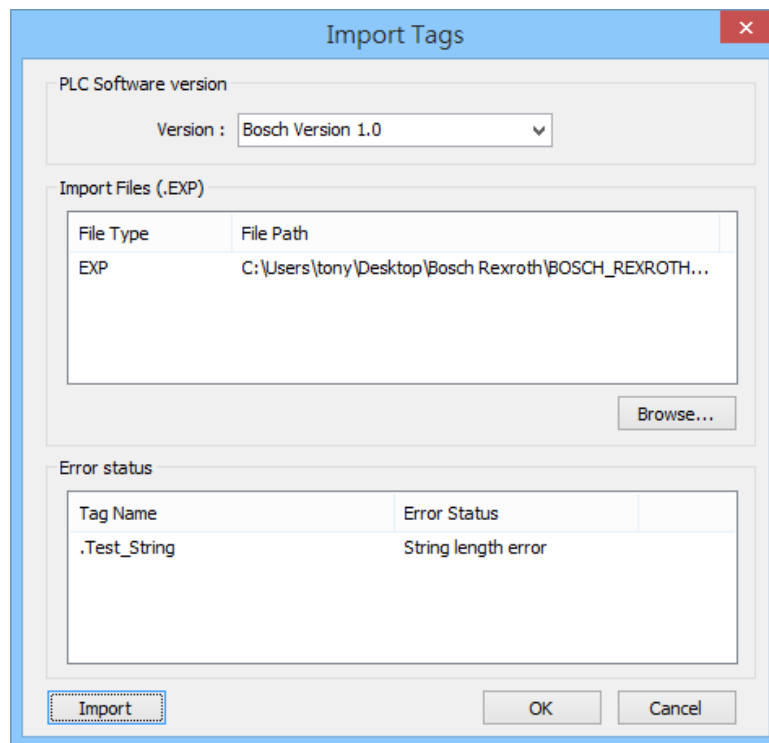
3. After editing the project, click **[Project]** -> **[Export]** to export the tags.



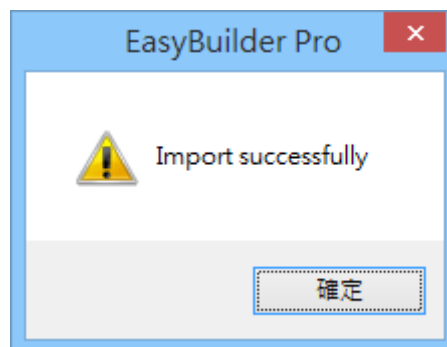
4. You may select all, a part of, or a single file to export. Click **[OK]**, enter the file name and designate the directory to store the file.



5. Launch EasyBuilder, select Bosch Rexroth driver, and import the address tags. The illegal addresses will be eliminated, and displayed in the **[Error status]** field. Click **[OK]** to leave.



6. "Import successfully" message will be displayed when successfully import the address tags.



Wiring Diagram:

RS-232 Terminal (Diagram 1 ~ Diagram 3)

Diagram 1

cMT Series	<i>cMT3151</i>
eMT Series	<i>eMT3070 / eMT3105 / eMT3120 / eMT3150</i>
MT-iE	<i>MT8073iE / MT8102iE</i>
MT-XE	<i>MT8092XE</i>
MT-iP	<i>MT6103iP</i>

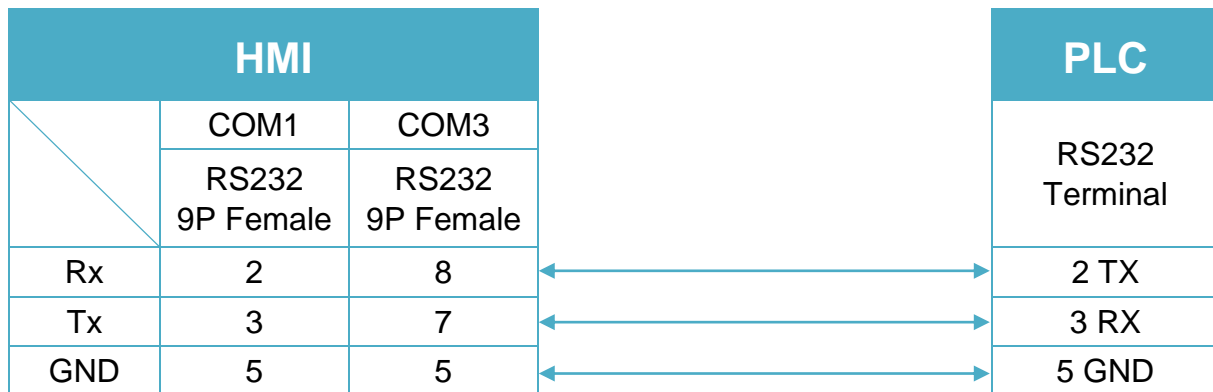


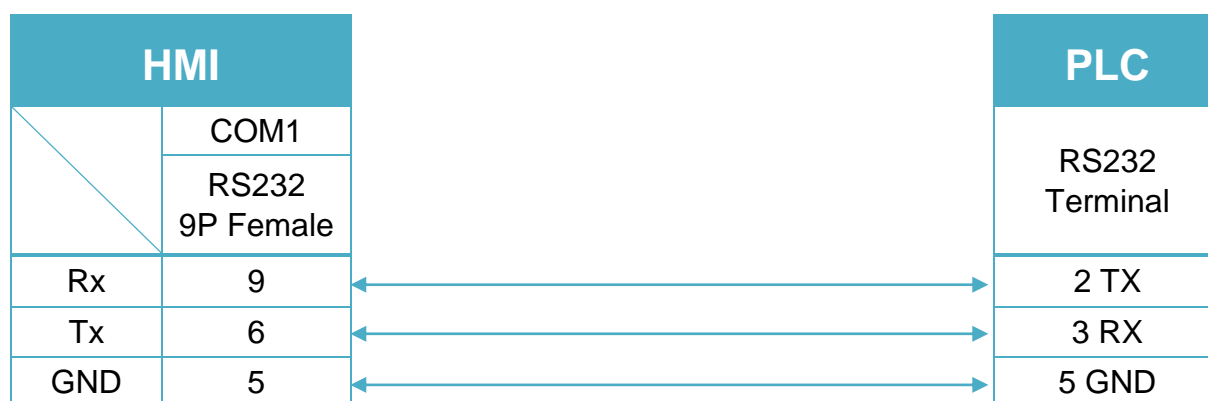
Diagram 2

cMT Series	cMT-SVR
mTV	mTV
MT-iE	MT8070iE / MT6070iE / MT8100iE / MT8121iE / MT8150iE / MT8071iE / MT6071iE / MT8072iE / MT6072iE / MT8073iE / MT8101iE / MT8102iE / MT8103iE
MT-XE	MT8121XE / MT8150XE / MT8090XE



Diagram 3

MT-iE	MT8050iE
MT-iP	MT6051iP / MT6071iP / MT8071iP



Bosch Rexroth IndraControl - Free Tag Names (Ethernet)

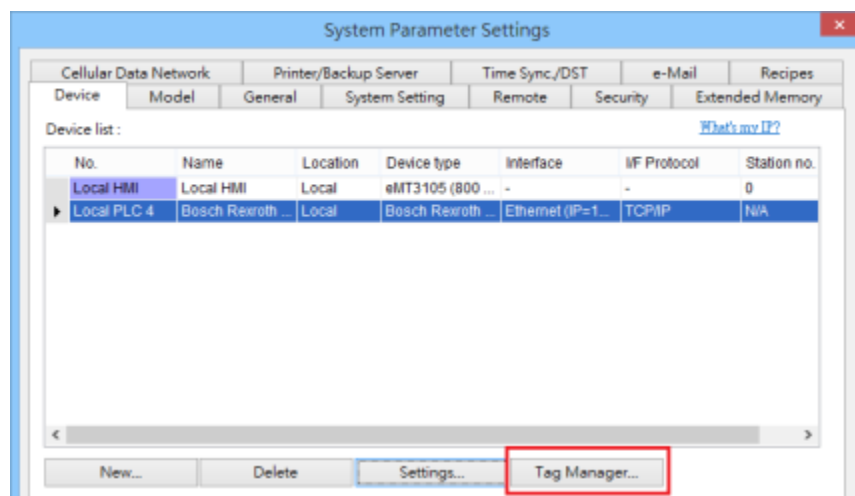
Supported series: IndraDrive HCS02

HMI Setting:

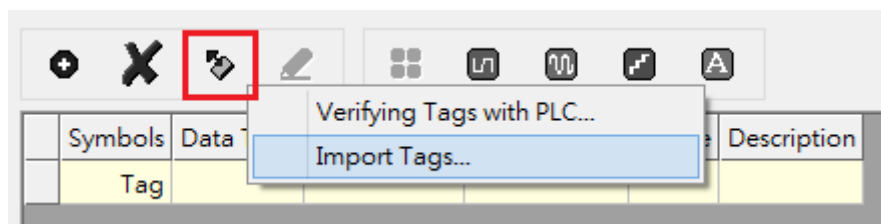
Parameters	Recommended	Options	Notes
PLC type	Bosch Rexroth IndraControl - Free Tag Names (Ethernet)		
PLC I/F	Ethernet		
Port no.	6042		

How to Import Tags:

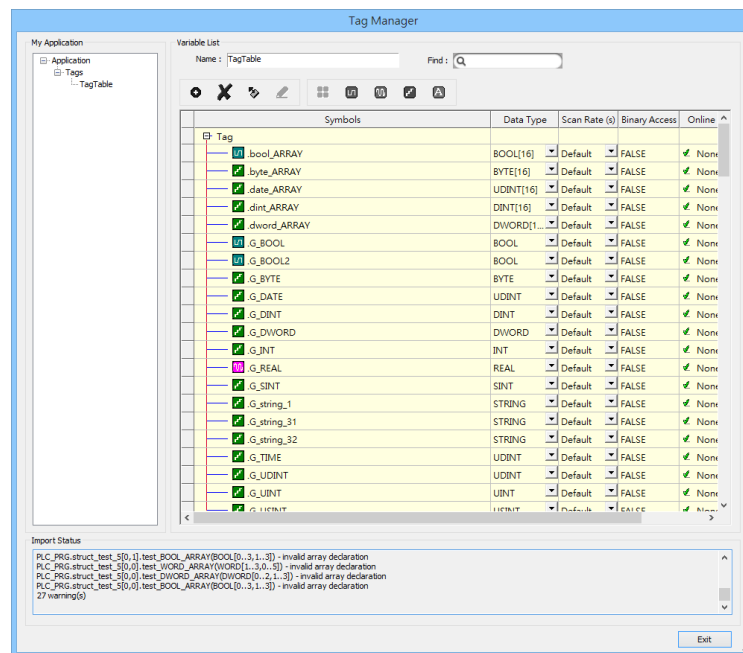
1. Click **[New]** to add **[Bosch Rexroth IndraControl - Free Tag Names (Ethernet)]** driver, and then click **[Tag Manager]**.



2. Select **[Get Tags]** » **[Import Tags]**, and then select the Tag **(.XML)** to be imported.



3. The successfully imported tags will be listed in a table. If any unsupported data type exists, a warning message will show in **[Import Status]** field.



Support Device Type:

S7-1200 data type	EasyBuilder data format	Memo
Bool	bit	
Byte	16-bit BCD, Hex, Binary, Unsigned	8-bit
SInt	16-bit BCD, Hex, Binary, Signed	8-bit
USInt	16-bit BCD, Hex, Binary, Unsigned	8-bit
Word	16-bit BCD, Hex, Binary, Unsigned	16-bit
Int	16-bit BCD, Hex, Binary, Signed	16-bit
UInt	16-bit BCD, Hex, Binary, Unsigned	16-bit
DWord	32-bit BCD, Hex, Binary, Unsigned	32-bit
DInt	32-bit BCD, Hex, Binary, Signed	32-bit
Real	32-bit Float	32-bit
UDInt	32-bit BCD, Hex, Binary, Unsigned	32-bit
Time	32-bit BCD, Hex, Binary, Unsigned	32-bit
Date	32-bit BCD, Hex, Binary, Unsigned	32-bit
String	Word array for ASCII input and display	Length=word

Wiring Diagram:

Diagram 1

Ethernet cable:



Bosch Rexroth SIS (Symbolic Addressing)

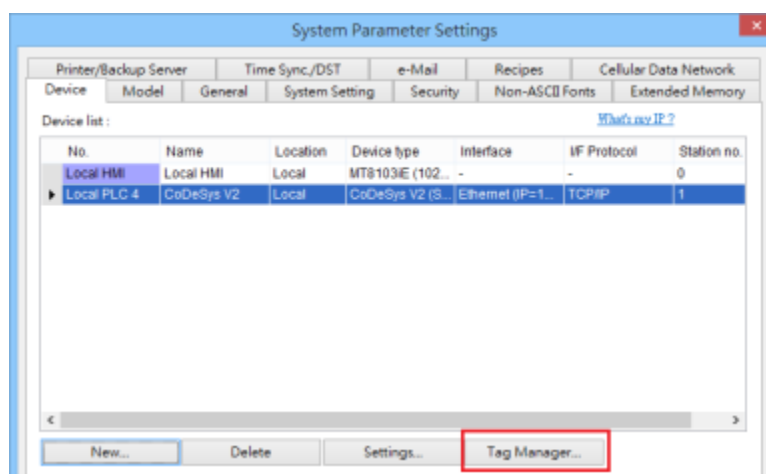
Supported Series: IndraDrive HCS02

HMI Setting:

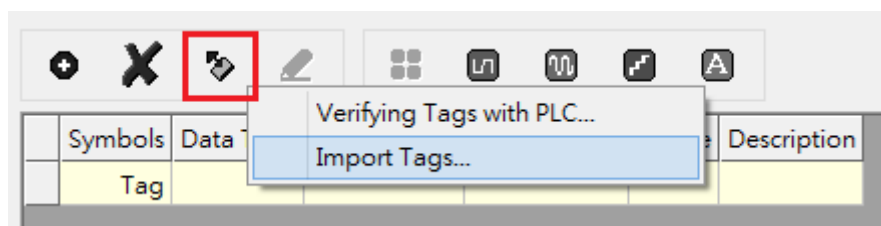
Parameters	Recommended	Options	Notes
PLC type	Bosch Roxroth SIS (Symbolic Addressing)		
PLC I/F	RS232		
Baud rate	38400		
Data bits	8		
Parity	None		
Stop bits	1		

How to Import Tags:

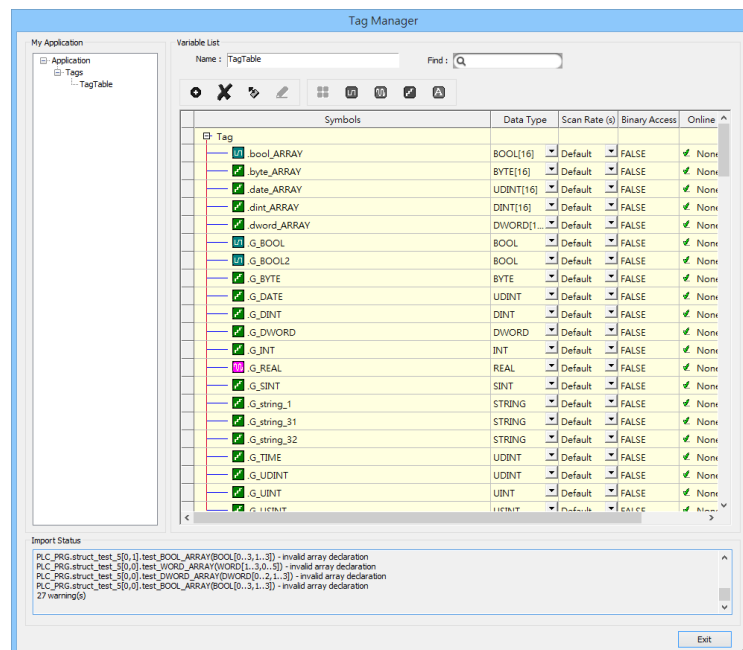
1. Click **[New]** to add **[CODESYS V2 (Symbolic Addressing)]** driver, and then click **[Tag Manager]**.



2. Select **[Get Tags]** » **[Import Tags]**, and then select the Tag **(.SYM_XML)** to be imported.



- The successfully imported tags will be listed in a table. If any unsupported data type exists, a warning message will show in **[Import Status]** field.



Note: Generate *.SYM_XML

- [Project]** -> **[Options]** -> **[Symbol configuration]** , select **[Dump symbol entries]** and **[Dump XML symbol table]**.
- Open **[Configure symbol file]**, select **[Export data entries]**

Wiring Diagram:

CM1-SC02A: RS-232 9P D-Sub (Diagram 1 ~ Diagram 3)

Diagram 1

cMT Series	<i>cMT3151</i>
eMT Series	<i>eMT3070 / eMT3105 / eMT3120 / eMT3150</i>
MT-iE	<i>MT8073iE / MT8102iE</i>
MT-XE	<i>MT8092XE</i>
MT-iP	<i>MT6103iP</i>

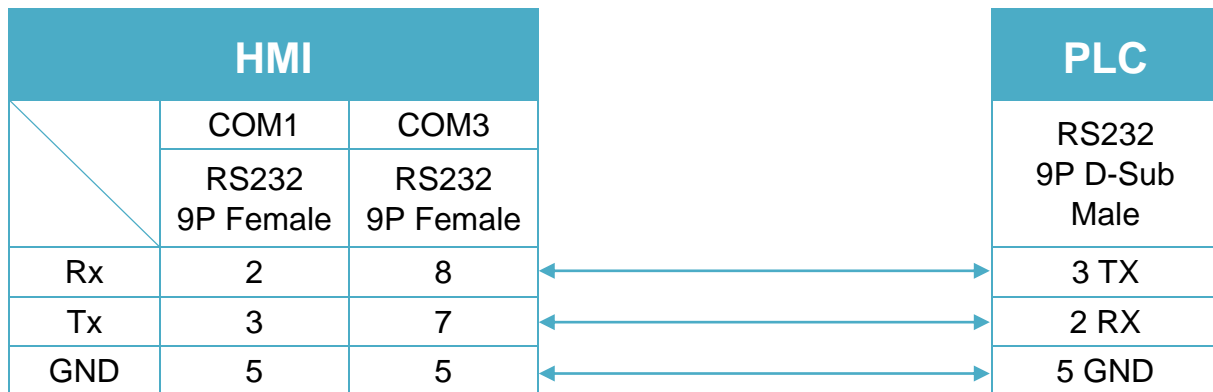


Diagram 2

cMT Series	cMT-SVR
mTV	mTV
MT-iE	MT8070iE / MT6070iE / MT8100iE / MT8121iE / MT8150iE / MT8071iE / MT6071iE / MT8072iE / MT6072iE / MT8073iE / MT8101iE / MT8102iE / MT8103iE
MT-XE	MT8121XE / MT8150XE / MT8090XE

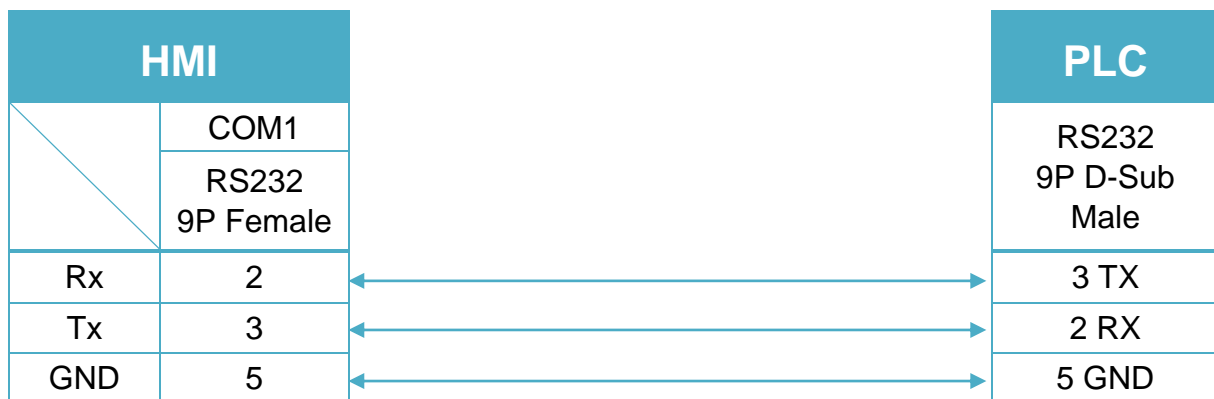


Diagram 3

MT-iE	MT8050iE
MT-iP	MT6051iP / MT6071iP / MT8071iP



Brother Speedio (Ethernet)

Supported Series: Brother Speedio (Ethernet)

Website: <http://www.brother.com/index.htm>

HMI Setting:

Parameters	Recommended	Options	Notes
PLC type	Brother Speedio (Ethernet)		
PLC I/F	Ethernet		
Port no.	10000		

Device Address:

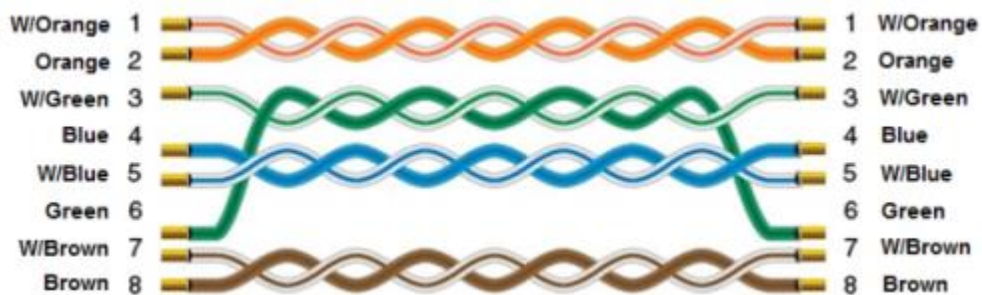
Bit/Word	Device type	Format	Range	Memo
B	X	HHH	0 ~ 3FF	
B	Y	HHH	0 ~ 3FF	
B	BX	HHH	0 ~ 3FF	
B	BY	HHH	0 ~ 3FF	
B	M	DDDD	0 ~ 8191	
B	LM_HS1	DDDD	0 ~ 1023	
B	LM_S1	DDDD	0 ~ 1023	
B	LM_HS2	DDDD	0 ~ 1023	
B	LM_S2	DDDD	0 ~ 1023	
W	BDX	DDD	0 ~ 255	
W	BDY	DDD	0 ~ 255	
W	D	DDDD	0 ~ 2047	
W	LD_HS1	DDDD	0 ~ 2047	
W	LT_CV_HS1	DDD	0 ~ 255	
W	LT_SV_HS1	DDD	0 ~ 255	
W	LC_CV_HS1	DDD	0 ~ 255	
W	LC_SV_HS1	DDD	0 ~ 255	
W	LD_S1	DDDD	0 ~ 2047	
W	LT_CV_S1	DDD	0 ~ 255	
W	LT_SV_S1	DDD	0 ~ 255	
W	LC_CV_S1	DDD	0 ~ 255	
W	LC_SV_S1	DDD	0 ~ 255	
W	LD_HS2	DDDD	0 ~ 2047	
W	LT_CV_HS2	DDD	0 ~ 255	

Bit/Word	Device type	Format	Range	Memo
W	LT_SV_HS2	DDD	0 ~ 255	
W	LC_CV_HS2	DDD	0 ~ 255	
W	LC_SV_HS2	DDD	0 ~ 255	
W	LD_S2	DDDD	0 ~ 2047	
W	LT_CV_S2	DDD	0 ~ 255	
W	LT_SV_S2	DDD	0 ~ 255	
W	LC_CV_S2	DDD	0 ~ 255	
W	LC_SV_S2	DDD	0 ~ 255	

Wiring Diagram:

Diagram 1

Ethernet cable:



CAN Bus CANopen Slave

Supported series: CAN Bus 2.0a / CAN Bus 2.0B device.

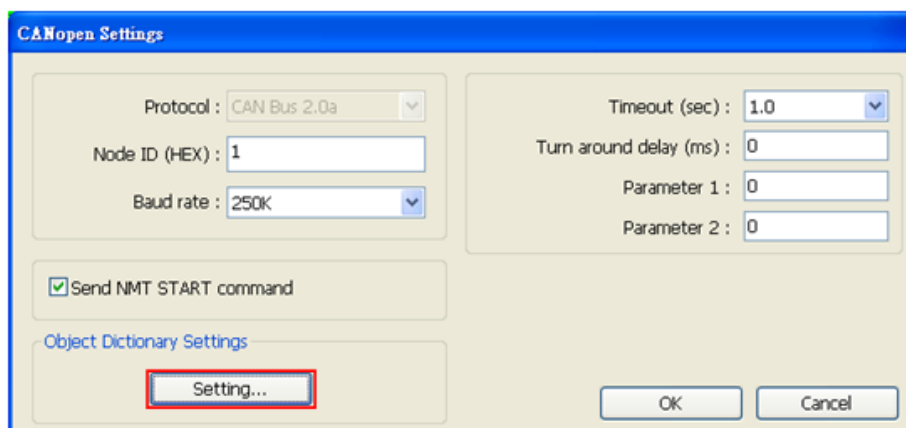
HMI Setting:

Parameters	Recommended	Options	Notes
PLC type	CAN Bus CANopen Slave		
Node ID	1	1~127	
Baud rate	250K	10K~1M	

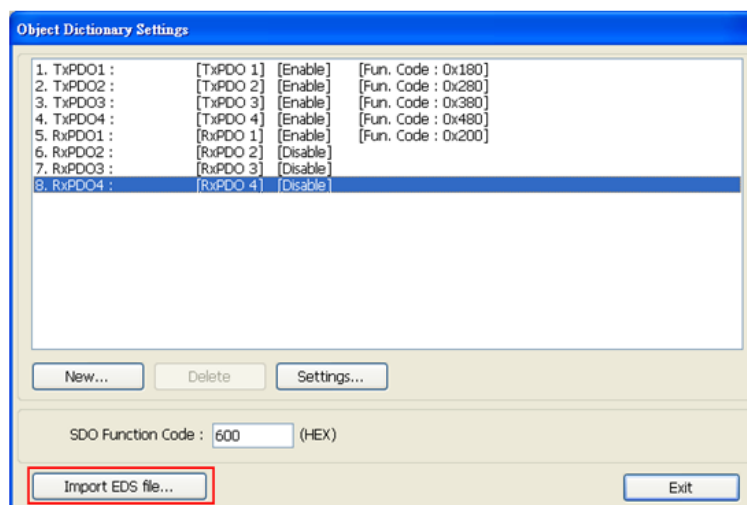
Online simulator	NO	Extend address mode	NO
------------------	----	---------------------	----

Follow the steps to import EDS file.

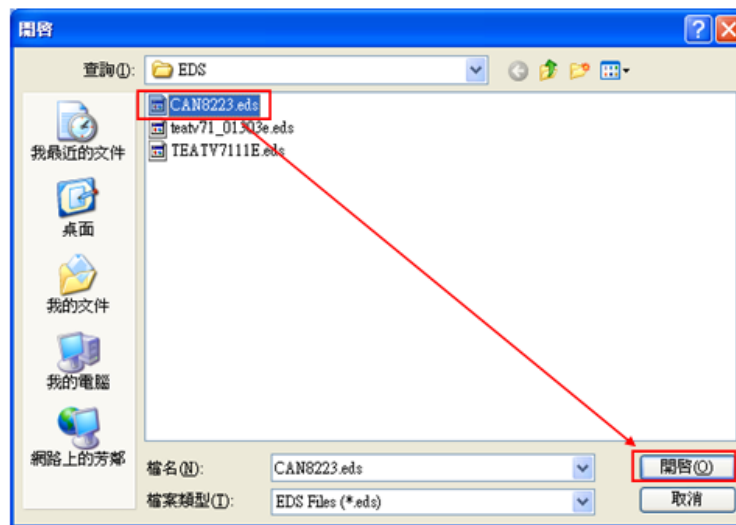
Step 1. Object Dictionary Settings -> Setting



Step 2. Import EDS file.



Step 3. Select the EDS file to be imported.



Step 4. Successfully import EDS file.



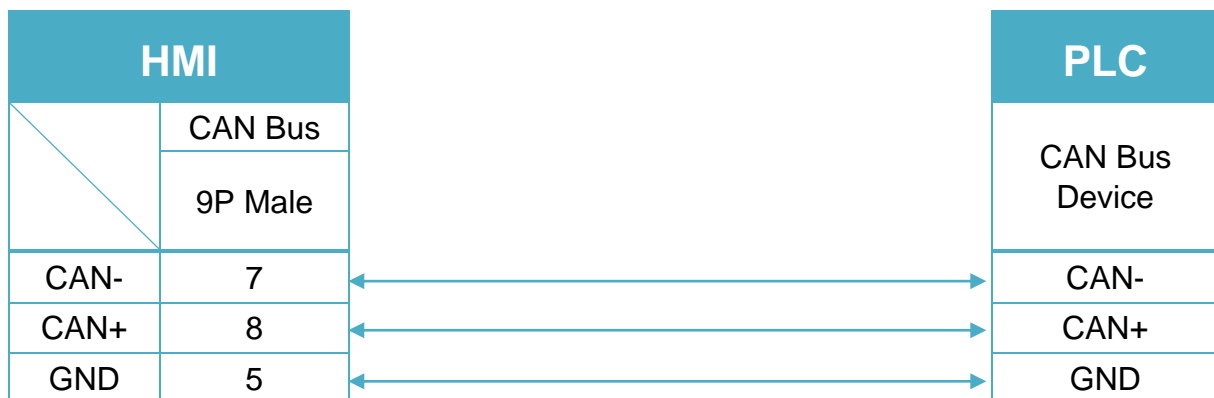
Device Address:

Bit/Wor	Device type	Format	Range	Memo
B	TxPDOOn_BIT	Dd	0 ~ 77	D : address (unit: byte) d : bit no.
B	RxPDOOn_BIT	Dd	0 ~ 77	D : address (unit: byte) d : bit no.
B	SDO_8bit_Bit	HHHHHHo	0 ~ FFFFFFF7	HHHH(Index)+HH(Sub-index)+o(Bit no)
B	SDO_16bit_Bit	HHHHHHdd	0 ~ HHHHHH15	HHHH(Index)+HH(Sub-index)+dd(Bit no)
W	TxPDOOn	D	0 ~ 7	

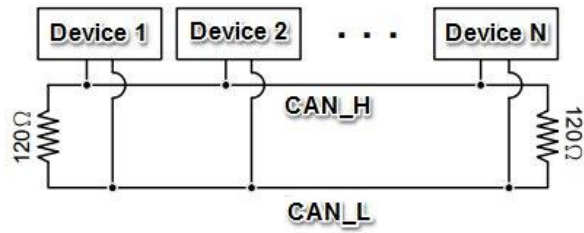
Bit/Wor	Device type	Format	Range	Memo
W	TxPDOOn_Byte	D	0 ~ 7	
W	RxPDOOn	D	0 ~ 7	
W	RxPDOOn_Byte	D	0 ~ 7	
W	SDO_8bit	HHHHHH	0~FFFFFF	HHHH(Index)+HH(Sub-index)
W	SDO_16bit	HHHHHH	0~FFFFFF	
W	SDO_32bit	HHHHHH	0~FFFFFF	

Wiring Diagram:

Diagram 1

cMT Series
cMT-3151
eMT Series
eMT3070 / eMT3105 / eMT3120 / eMT3150
MT-XE
MT8092XE


To minimize signal reflection on the CAN bus network, termination resistors should be installed at both ends of the network, as shown in the following figure. (eMT3070A has built-in termination resistor, so it is not required for eMT3070A)



Demo Project Link:



CAN Bus 2.0A/2.0B General and SAE J1939

Supported series: CAN Bus 2.0A / CAN Bus 2.0B / SAE J1939.

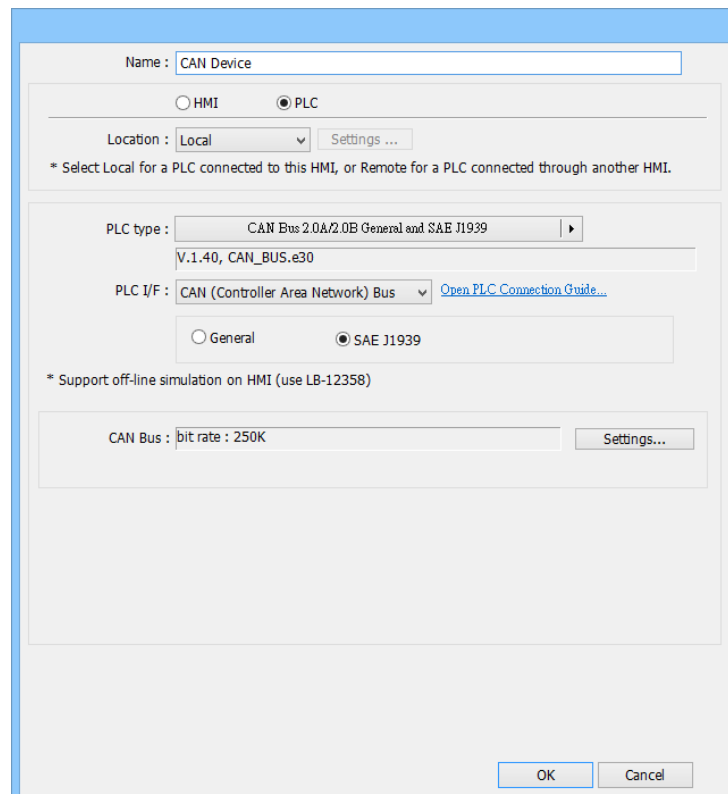
HMI Setting:

Parameters	Recommended	Options	Notes
PLC type	CAN Bus 2.0A/2.0B General and SAE J1939		
	General	General / SAE J1939	
Baud rate	250K	10K~1M	

Online simulator	NO	Extend address mode	NO
------------------	----	---------------------	----

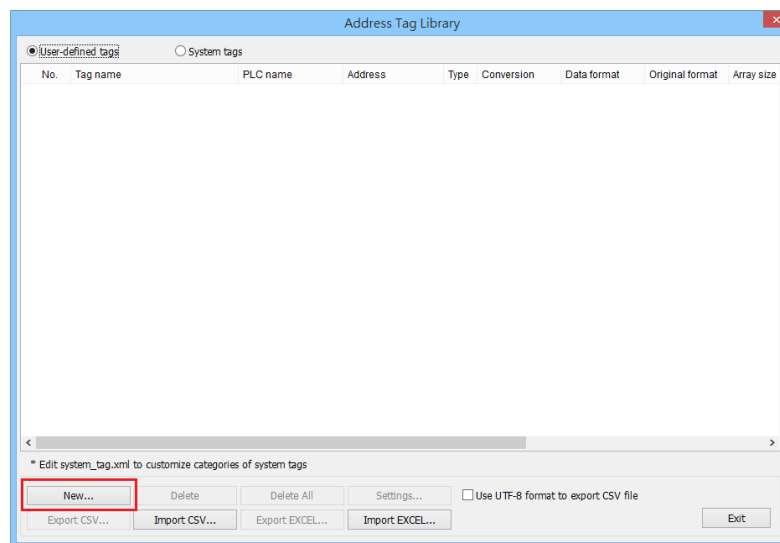
How to import SAE J1939 address tags:

1. In EasyBuilder Pro add **[CAN Bus 2.0A/2.0B General and SAE J1939]** driver.



The screenshot shows the 'HMI Settings' dialog box for a CAN Device. The 'Name' field is set to 'CAN Device'. The 'Device Type' is set to 'PLC'. The 'Location' is set to 'Local'. The 'PLC type' is set to 'CAN Bus 2.0A/2.0B General and SAE J1939'. The 'PLC I/F' is set to 'CAN (Controller Area Network) Bus'. The 'SAE J1939' option is selected. The 'CAN Bus' bit rate is set to '250K'. The dialog includes 'OK' and 'Cancel' buttons at the bottom right.

2. Open Address Tag Library, select **[User-defined tags]** and then click **[New]**.



3. Name: Enter the tag name.

PLC: Select the **SAE J1939**

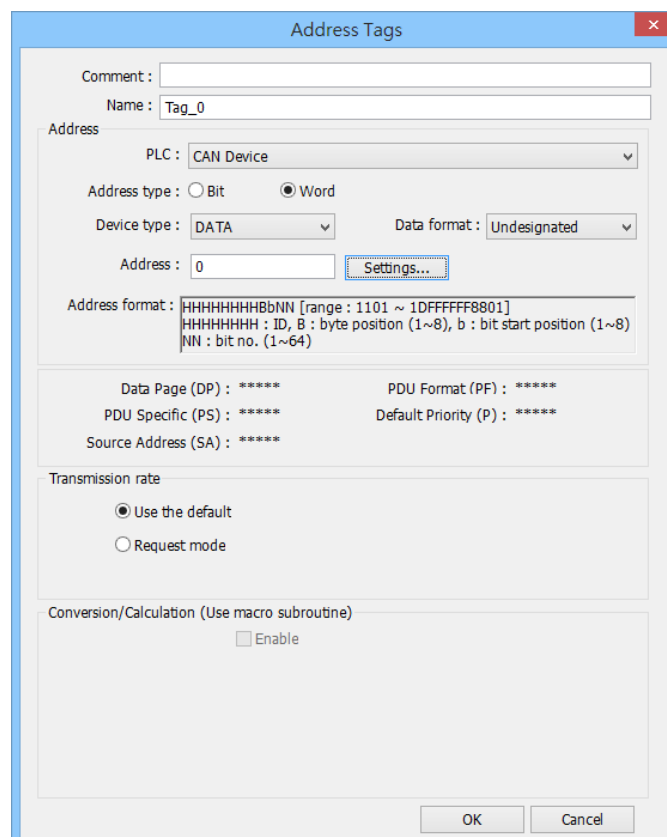
Address type: Select **Bit** or **Word**.

Transmission rate:

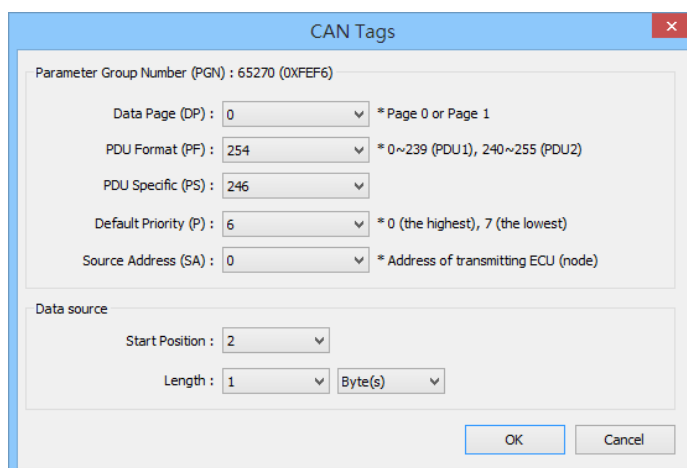
If **[Use the default]** is selected, then HMI will wait for the reply from CAN device.

If **[Request mode]** is selected, then HMI will send polling packet.

After entering the above information, click **[Settings]**.



4. Please set the following parameters according to the specification of the CAN device used.



CAN Tags

Parameter Group Number (PGN) : 65270 (0XFEF6)

Data Page (DP) : 0 * Page 0 or Page 1

PDU Format (PF) : 254 * 0~239 (PDU1), 240~255 (PDU2)

PDU Specific (PS) : 246

Default Priority (P) : 6 * 0 (the highest), 7 (the lowest)

Source Address (SA) : 0 * Address of transmitting ECU (node)

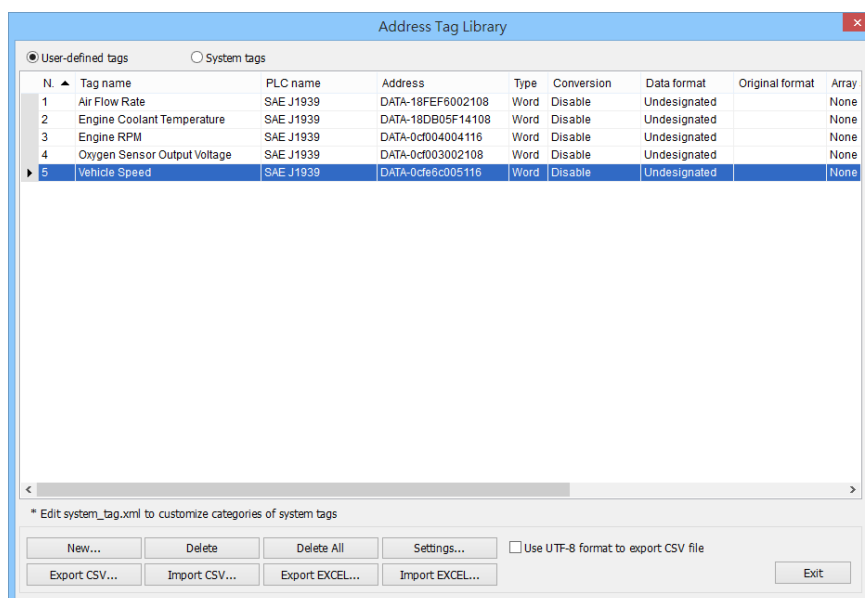
Data source

Start Position : 2

Length : 1 Byte(s)

OK Cancel

5. After building the tags click **[Exit]**.



Address Tag Library

User-defined tags System tags

N	Tag name	PLC name	Address	Type	Conversion	Data format	Original format	Array
1	Air Flow Rate	SAE J1939	DATA-18FEF6002108	Word	Disable	Undesignated		None
2	Engine Coolant Temperature	SAE J1939	DATA-18DB05F14108	Word	Disable	Undesignated		None
3	Engine RPM	SAE J1939	DATA-0cf004004116	Word	Disable	Undesignated		None
4	Oxygen Sensor Output Voltage	SAE J1939	DATA-0cf003002108	Word	Disable	Undesignated		None
5	Vehicle Speed	SAE J1939	DATA-0cf6c005116	Word	Disable	Undesignated		None

* Edit system_tag.xml to customize categories of system tags

New... Delete Delete All Settings... Use UTF-8 format to export CSV file

Export CSV... Import CSV... Export EXCEL... Import EXCEL... Exit

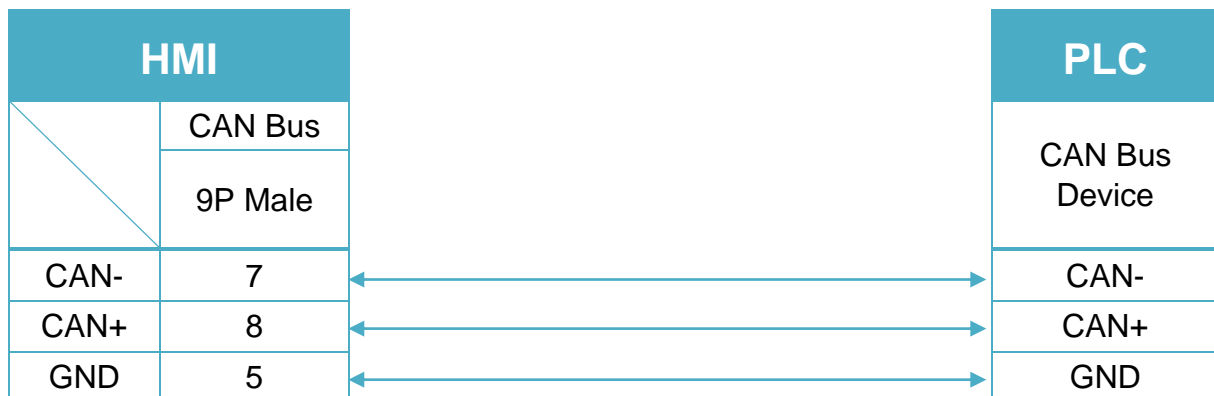
Device Address:

Bit/Wor	Device type	Format	Memo
B	DATA_Bit	HHHHHHHHBb	H: ID B: Byte position (1~8) b: bit start position (1~8)
W	DATA	HHHHHHHHBbNN	H: ID B: Byte position (1~8) b: bit start position (1~8) NN: bit no. (1~64)

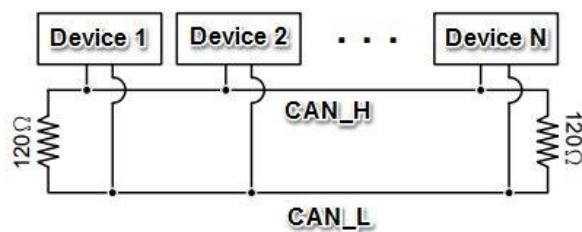
Wiring Diagram:

Diagram 1

cMT Series	cMT-3151
eMT Series	eMT3070 / eMT3105 / eMT3120 / eMT3150
MT-XE	MT8092XE



To minimize signal reflection on the CAN bus network, termination resistors should be installed at both ends of the network, as shown in the following figure. (eMT3070A has built-in termination resistor, so it is not required for eMT3070A)



CAS CI-1580A

Supported Series : CAS CI-1580A

Website : <http://www.globalcas.com/bemarket/main/main.php>

HMI Setting:

Parameters	Recommended	Options	Notes
PLC type	CAS CI-1580A		
PLC I/F	RS232	RS232/RS485 4W	
Baud rate	9600	9600 ~ 115200	
Data bits	8	8	
Parity	None	Even, Odd, None	
Stop bits	1	1	
PLC sta. no.	1	1 ~ 99	
Parameter1	0	0,1	0:BBC not used / 1:BBC used

Online simulator	YES
-------------------------	-----

PLC Setting:

F30 Parity bit	0 No Parity (default)
	1 Odd Parity
	2 Even Parity
F31 Baud rate	0 115200 bps
	1 76800 bps
	2 57600 bps
	3 38400 bps
	4 28800 bps
	5 19200 bps
	6 14400 bps
	7 9600 bps
	8 4800 bps
9 2400 bps	
F33 Communication Mode	0 Unilateral transmission mode
	1 Command mode
	2 LCD mode
	4 External display mode

F34 ID Number	1~99 (default:1)
F36 BCC selection mode	0 BCC not used
	1 BCC used
F40 Weight unit	0 kg
	1 g
	2 ton

Device Address:

Bit/Word	Device type	Format	Range	Memo
B	CURRENT_WEIGHT_HEAD	D	1	OL: OVER/UNDER LOAD
B	CURRENT_WEIGHT_HEAD	D	2	ST: Stable indicator
B	CURRENT_WEIGHT_HEAD	D	3	US: Unstable indicator
B	CURRENT_WEIGHT_HEAD	D	4	NT: NETWEIGHT
B	CURRENT_WEIGHT_HEAD	D	5	GS: GROSS WEIGHT
W	TARE	D	1	
W	TARE_RESET	D	1	
W	ZERO	D	1	
W	HOLD	D	1	
W	HOLD_RESET	D	1	
W	PACKMODE_START	D	1	
W	PACKMODE_STOP	D	1	
W	KEY_TARE	D	1	
W	CURRENT_WEIGHT	D	1	
W	CURRENT_WEIGHT_UNIT	D	1	0:KG , 1:ton , 2:g (F40)
W	LOWEST_LIMIT	D	1	
W	UPPER_LIMIT	D	1	
W	SERIAL_NUMBER	D	1	
W	CODE_NUMBER	D	1	
W	PART_NUMBER	D	1	

Wiring Diagram:

RS-232 9P D-Sub (Diagram 1 ~ Diagram 3)

Diagram 1

cMT Series	<i>cMT3151</i>
eMT Series	<i>eMT3070 / eMT3105 / eMT3120 / eMT3150</i>
MT-iE	<i>MT8073iE / MT8102iE</i>
MT-XE	<i>MT8092XE</i>
MT-iP	<i>MT6103iP</i>

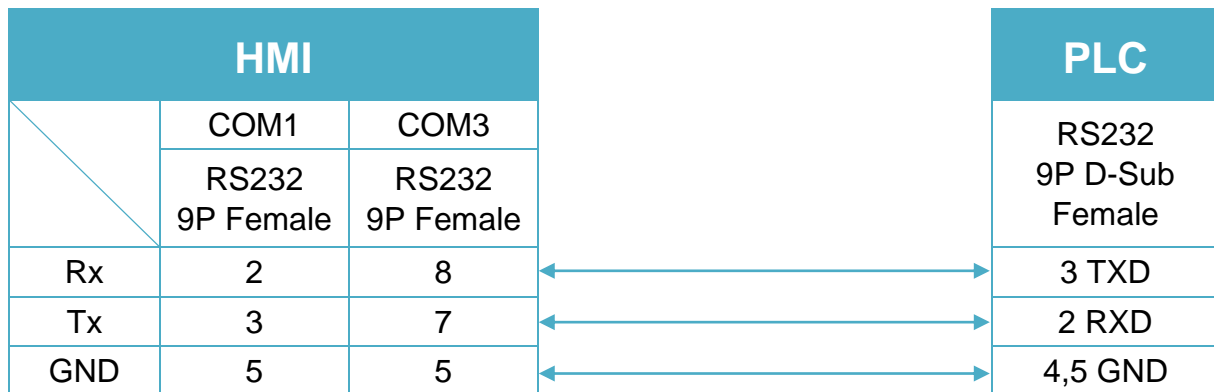


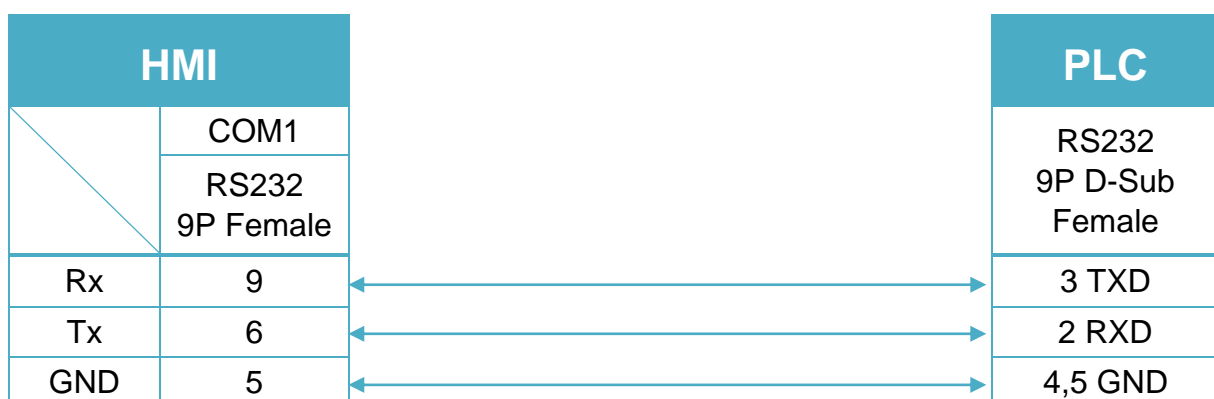
Diagram 2

cMT Series	cMT-SVR
mTV	mTV
MT-iE	MT8070iE / MT6070iE / MT8100iE / MT8121iE / MT8150iE / MT8071iE / MT6071iE / MT8072iE / MT6072iE / MT8073iE / MT8101iE / MT8102iE / MT8103iE
MT-XE	MT8121XE / MT8150XE / MT8090XE



Diagram 3

MT-iE	MT8050iE
MT-iP	MT6051iP / MT6071iP / MT8071iP



RS-485 4W 9P D-Sub (Diagram 4 ~ Diagram 7)

Diagram 4

cMT Series	<i>cMT3151</i>
eMT Series	<i>eMT3070 / eMT3105 / eMT3120 / eMT3150</i>
MT-iE	<i>MT8070iE / MT6070iE / MT8100iE / MT8121iE / MT8150iE</i>
MT-XE	<i>MT8121XE / MT8150XE</i>

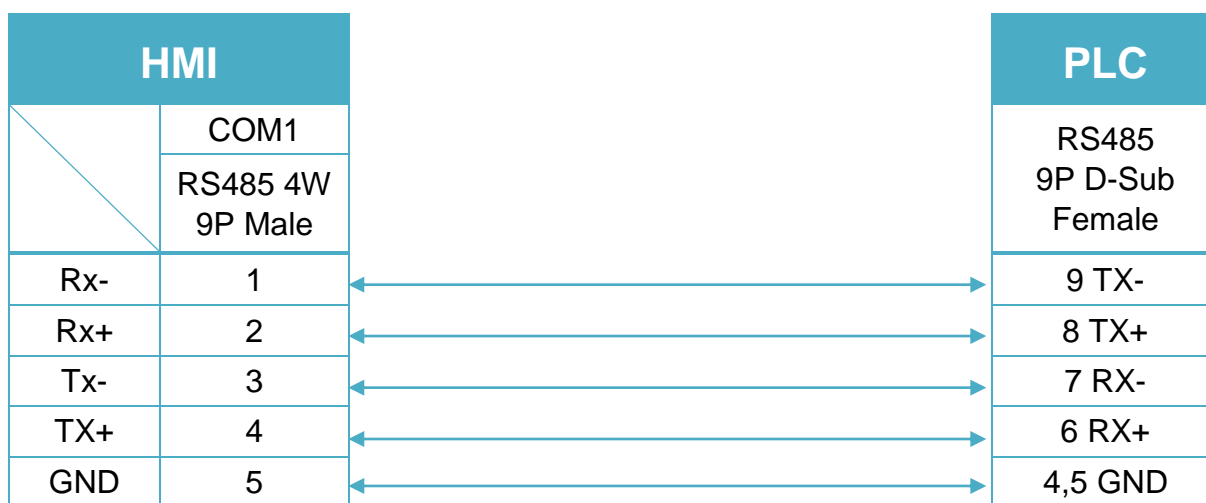


Diagram 5

cMT Series	<i>cMT-SVR</i>
mTV	<i>mTV</i>

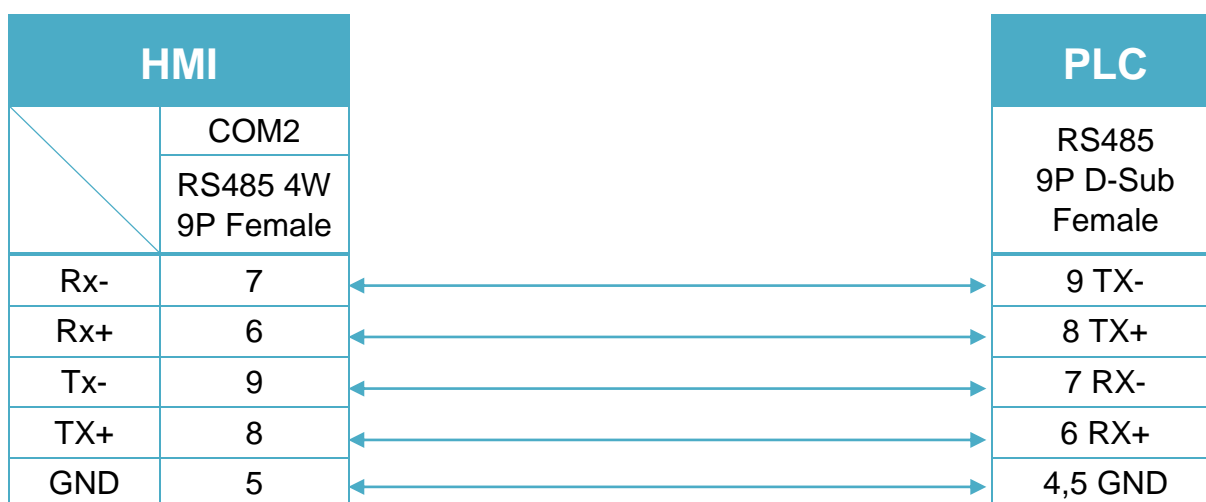


Diagram 6

MT-iE	<i>MT8071iE / MT6071iE / MT8072iE / MT6072iE / MT8073iE / MT8101iE / MT8102iE / MT8103iE</i>
MT-XE	<i>MT8090XE / MT8092XE</i>
MT-iP	<i>MT6071iP / MT8071iP / MT6103iP</i>

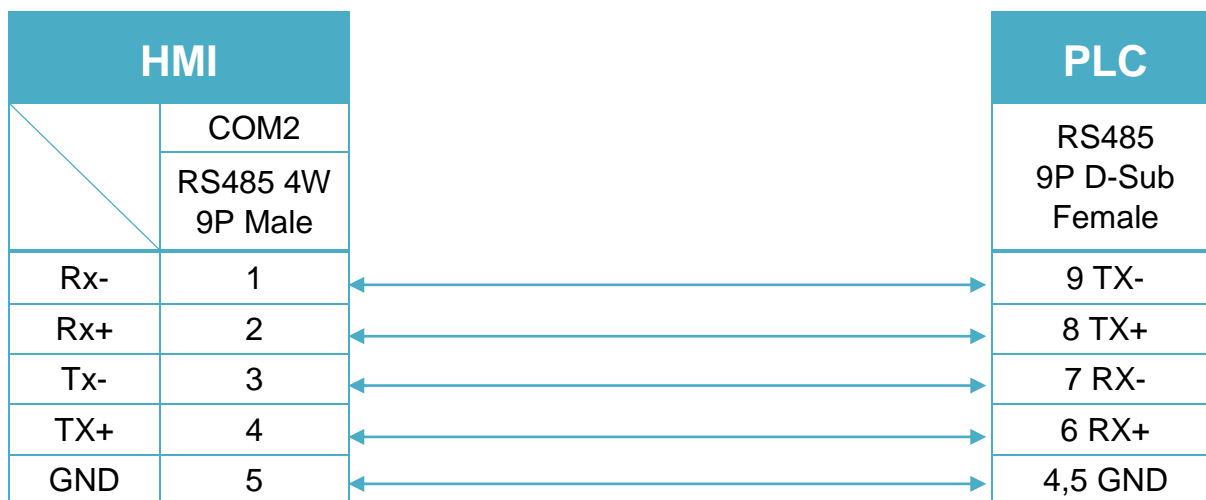
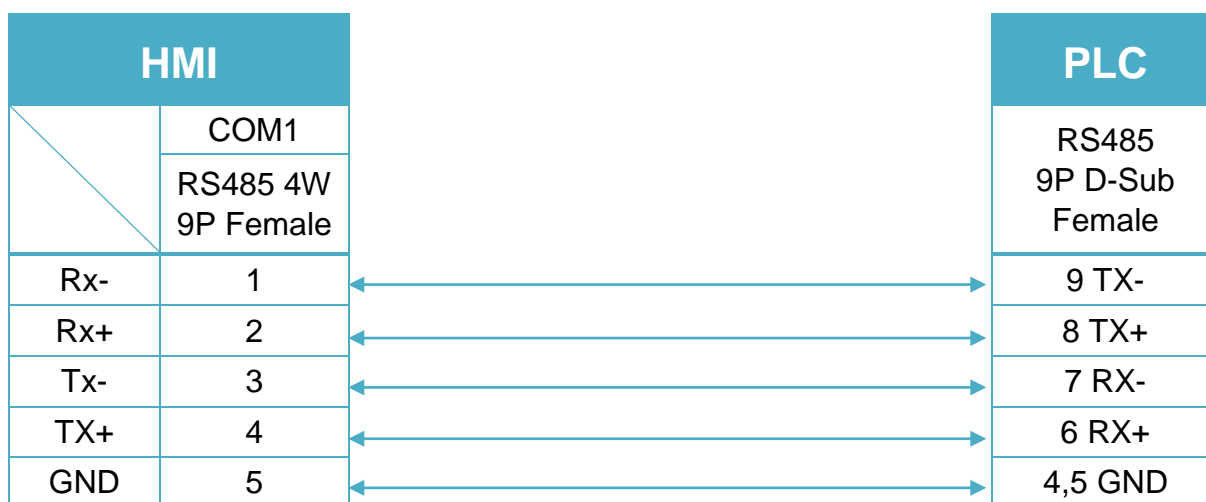


Diagram 7

MT-iE	<i>MT8050iE</i>
MT-iP	<i>MT6051iP</i>



CD MODBUS RTU

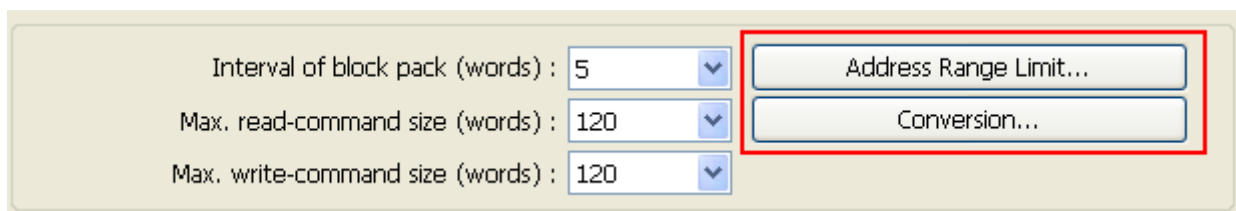
Supported Series : REVO-CL / REVO-M / REVO E / CD3000E / MULTIDRIVE / REVO-TC / REVO-PC

Website : <http://www.cdautomation.com/>

HMI Setting:

Parameters	Recommended	Options	Notes
PLC type	CD MODBUS RTU		
PLC I/F	RS485	RS232/RS485	
Baud rate	9600	9600~115200	
Data bits	8	7, 8	
Parity	Even	Even, Odd, None	
Stop bits	1	1, 2	
PLC sta. no.	1	0-255	

Online simulator	YES	Broadcast	YES
Extend address mode	YES		



Interval of block pack (words) : 5

Max. read-command size (words) : 120

Max. write-command size (words) : 120

Address Range Limit...

Conversion...

[Address Range Limit]

The address range of 0x, 1x, and 0x_multi_coils device types can be set.

[Conversion]

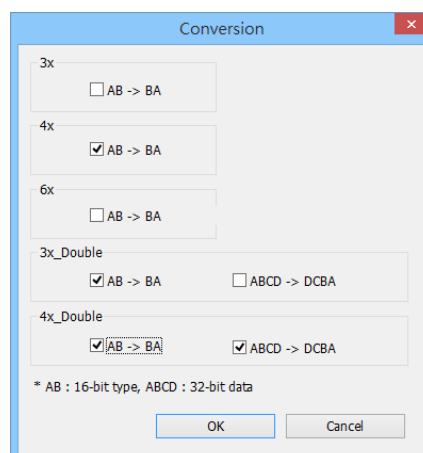
The 3x_Double and 4x_Double address types are added. If [ABCD ->CDAB] check box is selected, please select 3x_Double and 4x_Double address types.

Device Address:

Bit/Word	Device type	Format	Range	Memo
B	0x	DDDDD	1 ~ 65535	Output bit
B	0x_multi_coils	DDDDD	1 ~ 65535	Write multiple coils
B	0x_single_Bit	DDDDD	1 ~ 65535	
B	1x	DDDDD	1 ~ 65535	Input bit (read only)
B	1x_single_Bit	DDDDD	1 ~ 65535	
B	3x_Bit	DDDDDdd	100 ~ 6553515	Input Register bit (read
B	4x_Bit	DDDDDdd	100 ~ 6553515	Output Register bit
B	6x_Bit	DDDDDdd	100 ~ 6553515	Output Register bit
B	0x_1 ~ 0x_9	DDDDD	1 ~ 65535	
B	1x_1 ~ 1x_9	DDDDD	1 ~ 65535	
W	3x	DDDDD	1 ~ 65535	Input Register (read only)
W	3x_MAX1W	DDDDD	1 ~ 65535	Display 32 bits *Note1
DW	3x_MAX2W	DDDDD	1 ~ 65535	*Note1
DW	3x_Double	DDDDD	1 ~ 65535	*Note2
W	4x	DDDDD	1 ~ 65535	Output Register
W	4x_MAX1W	DDDDD	1 ~ 65535	Display 32 bits *Note1
DW	4x_MAX2W	DDDDD	1 ~ 65535	*Note1
DW	4x_Double	DDDDD	1 ~ 65535	*Note2
W	4x_32Bit	DDDDD	1 ~ 65535	Output Register *Note1
DW	5x	DDDDD	1 ~ 65535	4x double word swap
W	6x	DDDDD	1 ~ 65535	4x single word write

Note1: MAX1W and 4X_32Bit read/write 1 word for each package and display a 32-bits value, whereas MAX2W reads/write 2 words for each package.

Note2: Go the [System Parameter Settings] -> [Device Properties] and click [Conversion] to set the data format of device types 3x, 4x, 6x, 3x_double, 4x double.



NOTE:

Address type “5x” is mapping to Hold Reg. The communication protocol of 5x is almost the same as “4x” except that “5x” swaps double word.

If 4x contains the following information:

Address	1	2	3	4	5	6	...
Data in word	0x1	0x2	0x3	0x4	0x5	0x6	
Data	0x20001		0x40003		0x60005		

For 5x, it will be:

Address	1	2	3	4	5	6	...
Data in word	0x2	0x1	0x4	0x3	0x6	0x5	
Data	0x10002		0x30004		0x50006		

Modbus RTU function code:

0x	0x01	Read coil	0x05	write single coil
0x_multi_coils	0x01	Read coil	0x0f	write multiple coils
1x	0x02	Read discrete input	N/A	for write operation
3x	0x04	Read input register	N/A	for write operation
4x	0x03	Read holding register	0x10	write multiple registers
5x	0x03	Read holding register	0x10	write multiple registers

(Note: reverse word order in double word format)

3xbit is equivalent to 3x

4xbit is equivalent to 4x

6x	0x03	Read holding register	0x06	write single register
----	------	-----------------------	------	-----------------------

(Note: 6x is limited to device of one word only)

Wiring Diagram:

RS-485 2W 9P D-Sub (Diagram 1 ~ Diagram 6)

Diagram 1

cMT Series *cMT3151*

eMT Series *eMT3070 / eMT3105 / eMT3120 / eMT3150*

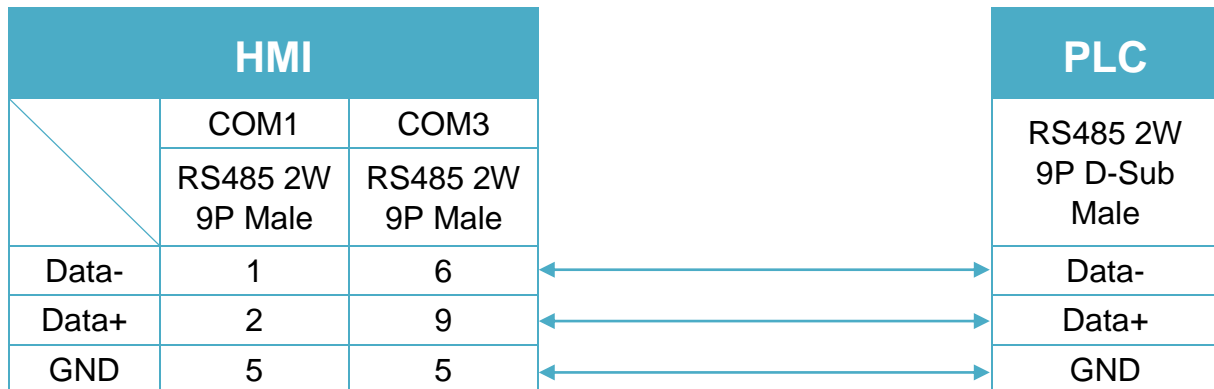


Diagram 2

cMT Series *cMT-SVR*

mTV *mTV*

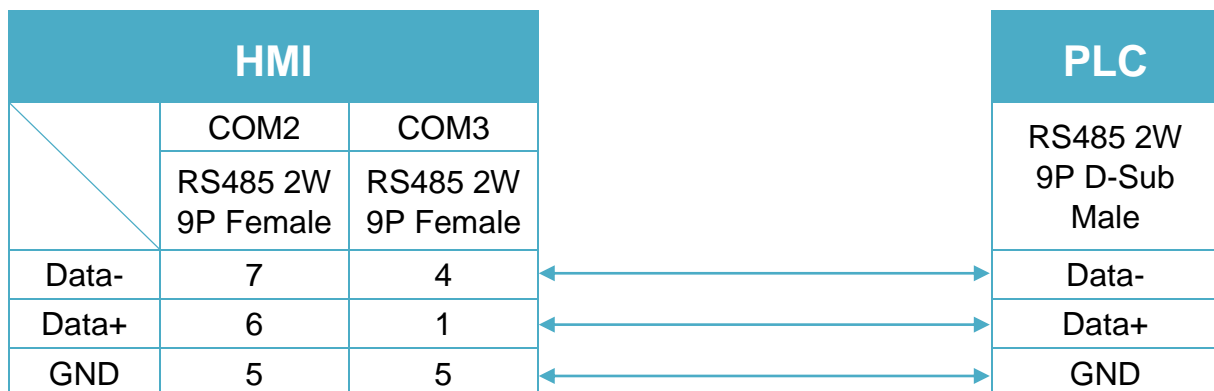


Diagram 3

MT-iE *MT8070iE / MT6070iE / MT8100iE / MT8121iE / MT8150iE*

MT-XE *MT8121XE / MT8150XE*

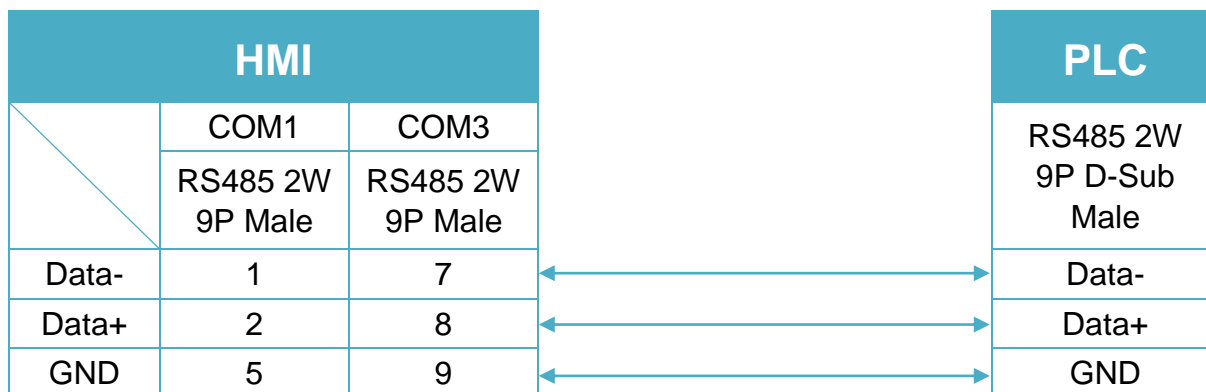


Diagram 4

MT-iE *MT8071iE / MT6071iE / MT8072iE / MT6072iE / MT8073iE /
MT8101iE / MT8102iE / MT8103iE*

MT-XE *MT8090XE / MT8092XE*

MT-iP *MT6103iP*

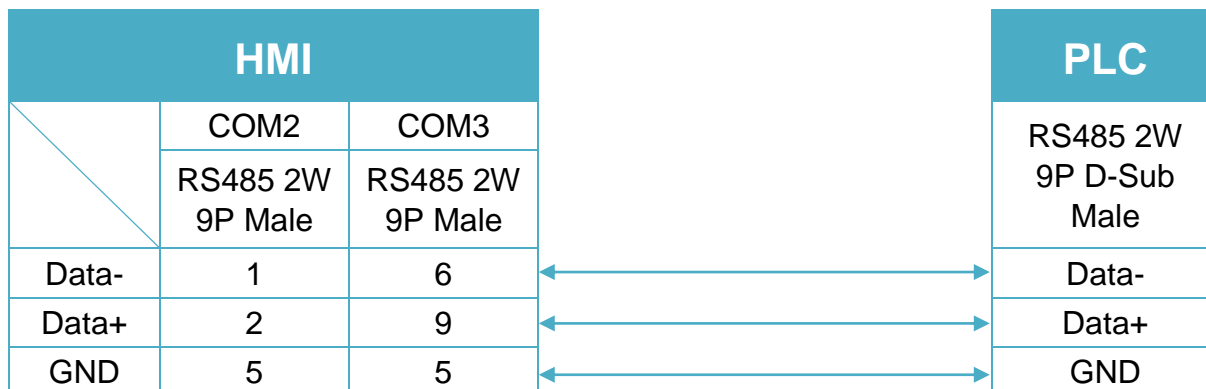


Diagram 5

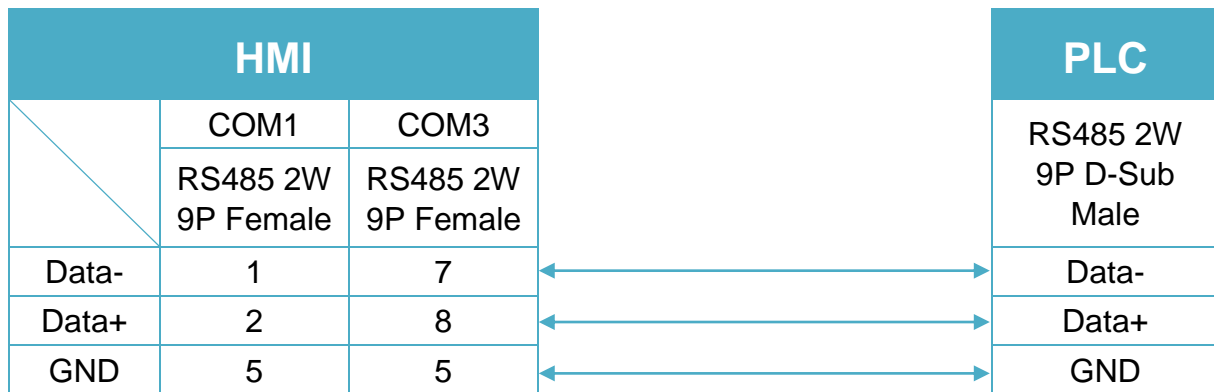
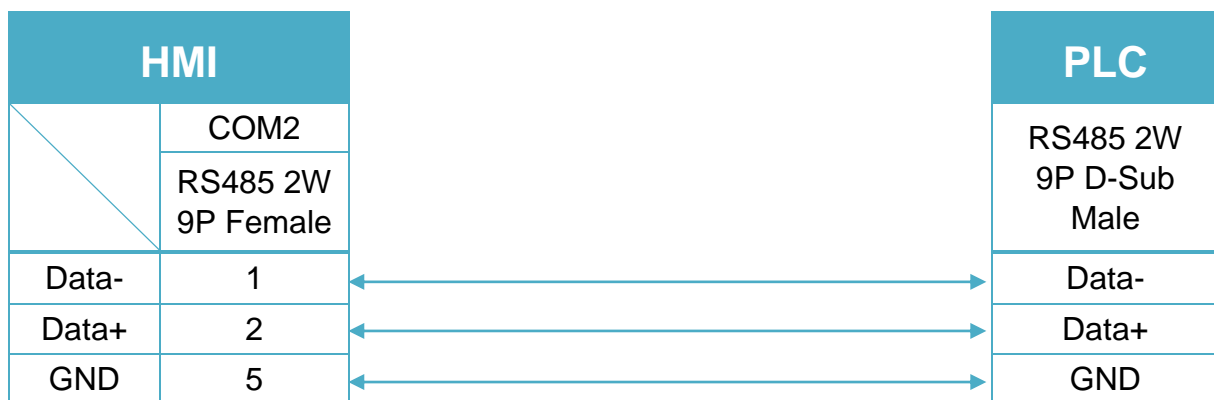
MT-iE *MT8050iE*
MT-iP *MT6051iP*


Diagram 6

MT-iP *MT6071iP / MT8071iP*


CD MODBUS TCP/IP

Supported Series: REVO-CL / REVO-M / REVO E / CD3000E / MULTIDRIVE / REVO-TC / REVO-PC

Website : <http://www.cdautomation.com/>

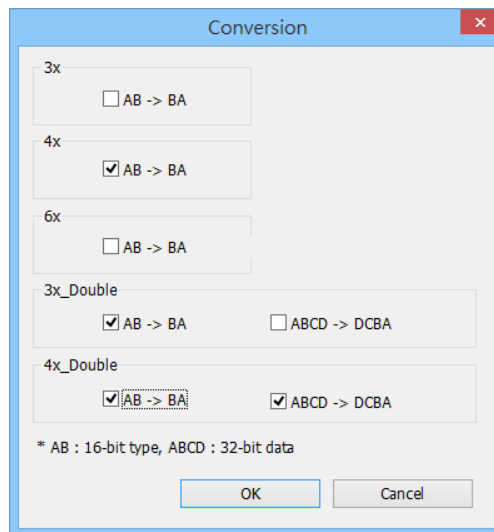
HMI Setting:

Parameters	Recommended	Options	Notes
PLC type	CD MODBUS TCP/IP		
PLC I/F	Ethernet		
Port no.	502		
PLC sta. no.	1	0~255	

Device Address:

Bit/Word	Device type	Format	Range	Memo
B	0x	DDDDD	1 ~ 65535	Output bit
B	0x_single_Bit	DDDDD	1 ~ 65535	
B	0x_multi_coils	DDDDD	1 ~ 65535	Write multiple coils
B	1x	DDDDD	1 ~ 65535	Input bit (read only)
B	1x_single_Bit	DDDDD	1 ~ 65535	
B	3x_bit	DDDDDdd	100 ~ 6553515	Input Register bit(read
B	4x_bit	DDDDDdd	100 ~ 6553515	Output Register bit
B	6x_bit	DDDDDdd	100 ~ 6553515	Output Register bit
B	0x_1 ~ 0x_9	DDDDD	1 ~ 65535	
B	1x_1 ~ 1x_9	DDDDD	1 ~ 65535	
W	3x	DDDDD	1 ~ 65535	Input Register
DW	3x_Double	DDDDD	1 ~ 65535	*Note1
W	4x	DDDDD	1 ~ 65535	Output Register
DW	4X_Double	DDDDD	1 ~ 65535	*Note1
DW	5x	DDDDD	1 ~ 65535	4x double word swap
W	6x	DDDDD	1 ~ 65535	4x single word write
W	4x string central europe	DDDDD	1 ~ 65535	Convert the Central Europe ASCII to Unicode.
W	4x string central europe (rev)	DDDDD	1 ~ 65535	

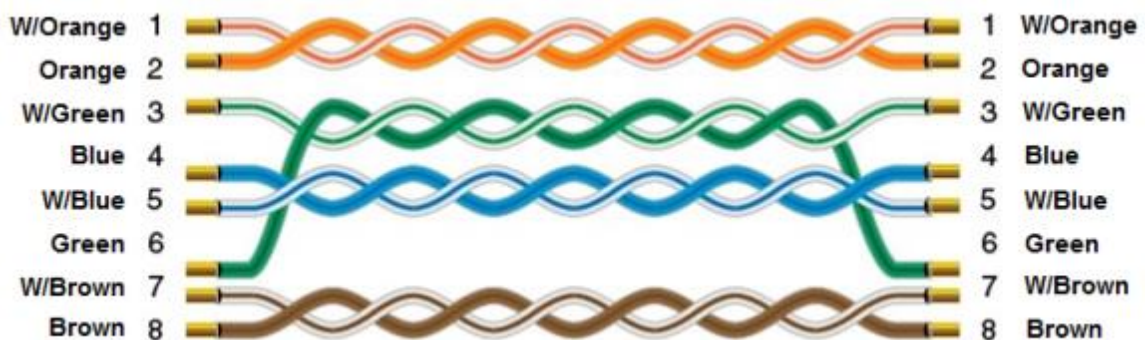
Note1: Go the [System Parameter Settings] -> [Device Properties] and click [Conversion] to set the data format of device types 3x, 4x, 6x, 3x_double, 4x double.



Wiring Diagram:

Diagram 1

Ethernet cable:



Change

Supported Series: Compressor controller

Website: <http://www.sh-changjia.com/>

HMI Setting:

Parameters	Recommended	Options	Notes
PLC type	Change		
PLC I/F	RS485 2W		
Baud rate	9600		
Data bits	8		
Parity	None		
Stop bits	1		
PLC sta. no.	1	1~6	

Device Address:

Bit/Word	Device type	Format	Range	Memo
B	CTL	DDD	0 ~ 5, 128, 150	Write only
DW	SET	DDD	0 ~ 57, 128	
DW	STATUS	DD	1 ~ 20	Read only

Wiring Diagram:

RS-485 2W Terminal (Diagram 1 ~ Diagram 6)

Diagram 1

cMT Series

cMT3151

eMT Series

eMT3070 / eMT3105 / eMT3120 / eMT3150

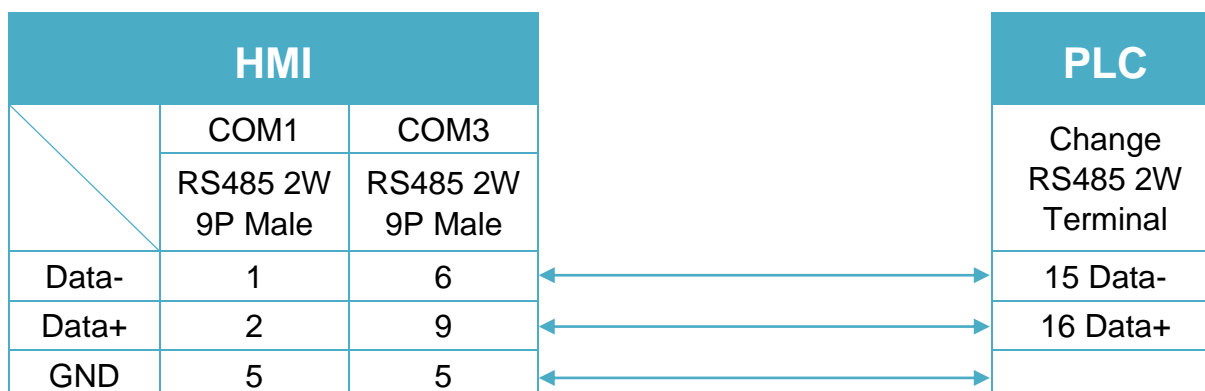


Diagram 2

cMT Series *cMT-SVR*

mTV *mTV*

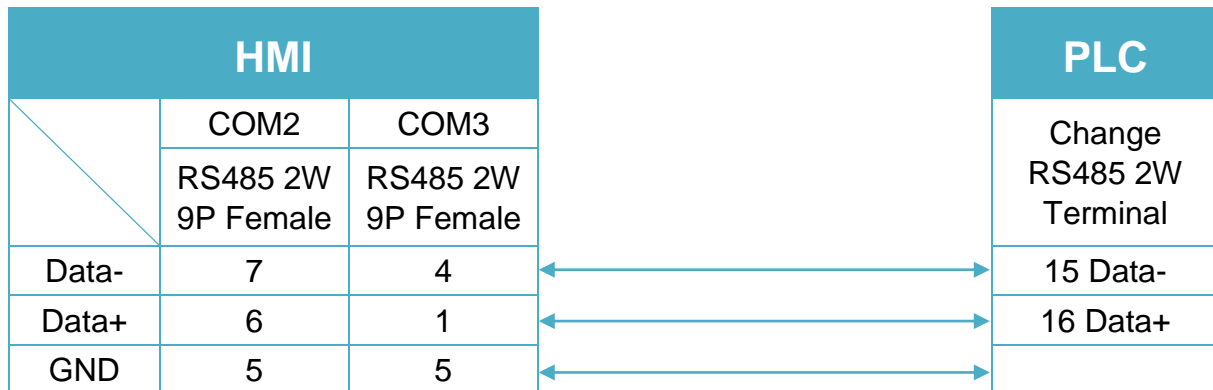


Diagram 3

MT-iE *MT8070iE / MT6070iE / MT8100iE / MT8121iE / MT8150iE*

MT-XE *MT8121XE / MT8150XE*

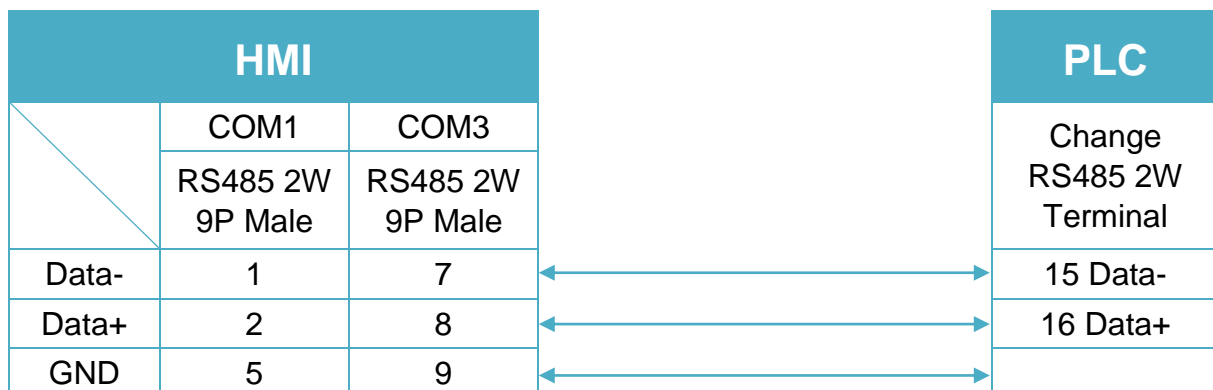
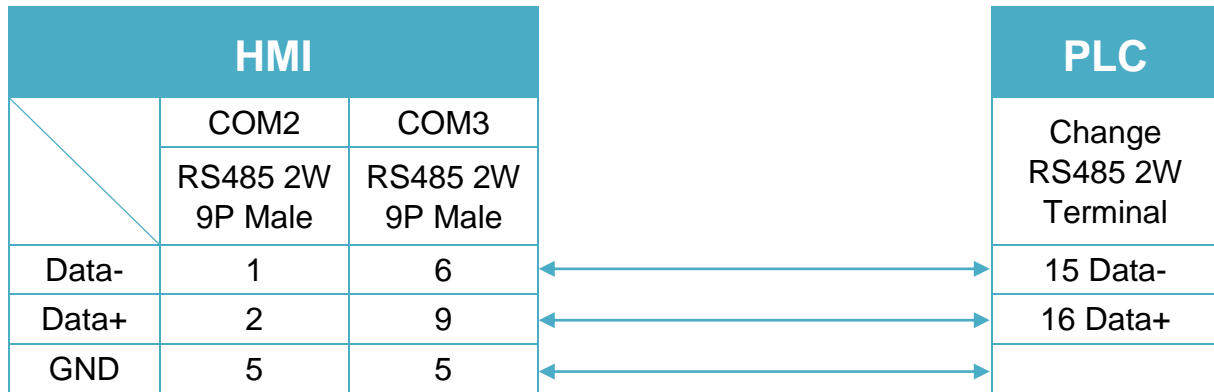


Diagram 4

MT-iE *MT8071iE / MT6071iE / MT8072iE / MT6072iE / MT8073iE / MT8101iE / MT8102iE / MT8103iE*

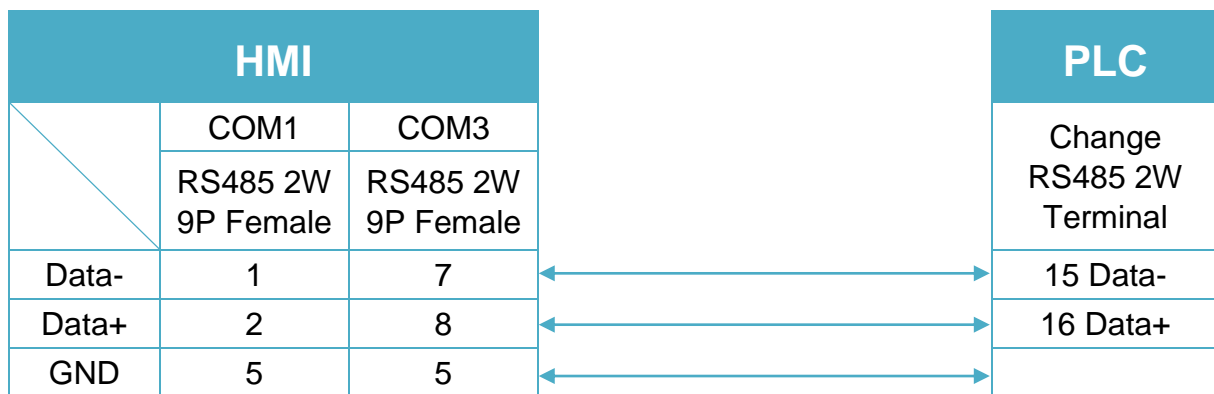
MT-XE *MT8090XE / MT8092XE*

MT-iP *MT6103iP*

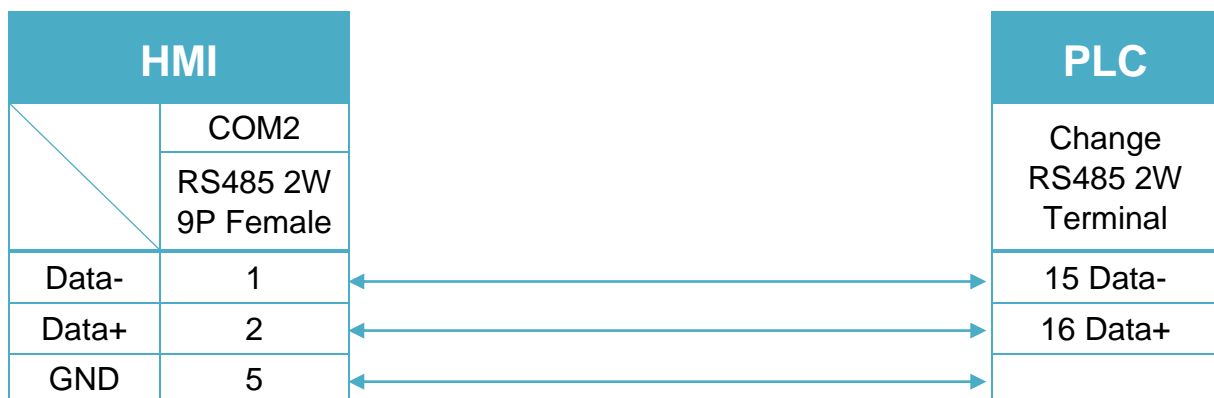

Diagram 5

MT-iE *MT8050iE*

MT-iP *MT6051iP*


Diagram 6

MT-iP *MT6071iP / MT8071iP*



Cimon CM1-CP4A/ECO1A

Supported Series: Cimon CM1 series, CP4A module

Website: <http://www.kdtsys.com>

HMI Setting:

Parameters	Recommended	Options	Notes
PLC type	Cimon CM1-CP4A/ECO1A		
PLC I/F	RS232		
Baud rate	38400		
Data bits	8		
Parity	None		
Stop bits	1		
PLC sta. no.	1		

Device Address:

Bit/Word	Device type	Format	Range	Memo
B	X	DDDDh	0 ~ 1023f	0-1F Read Only
B	Y	DDDDh	0 ~ 1023f	
B	M	DDDh	0 ~ 511f	
B	K	DDDh	0 ~ 127f	
B	L	DDDh	0 ~ 127f	
B	F	DDDh	0 ~ 127f	Read Only
B	T	DDDh	0 ~ 102f	
B	C	DDDh	0 ~ 102f	
W	D	DDDD	0 ~ 9999	
W	S	DD	0 ~ 99	Max. Range: 99
W	TS	DDDD	0 ~ 1023	
W	TC	DDDD	0 ~ 1023	
W	CS	DDDD	0 ~ 1023	
W	CC	DDDD	0 ~ 1023	

Wiring Diagram:

CM1-CP4A: RS-232 6P RJ11 (Diagram 1 ~ Diagram 3)

Diagram 1

cMT Series	<i>cMT3151</i>
eMT Series	<i>eMT3070 / eMT3105 / eMT3120 / eMT3150</i>
MT-iE	<i>MT8073iE / MT8102iE</i>
MT-XE	<i>MT8092XE</i>
MT-iP	<i>MT6103iP</i>

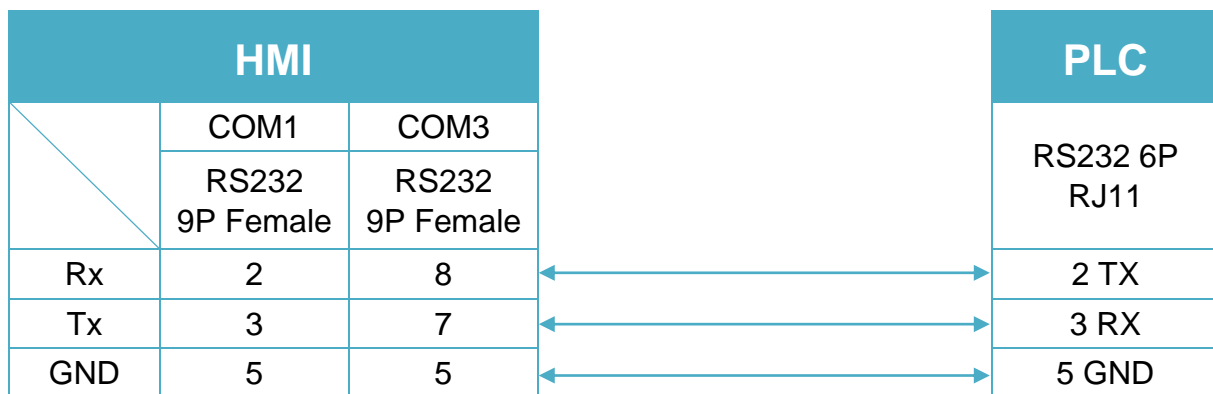
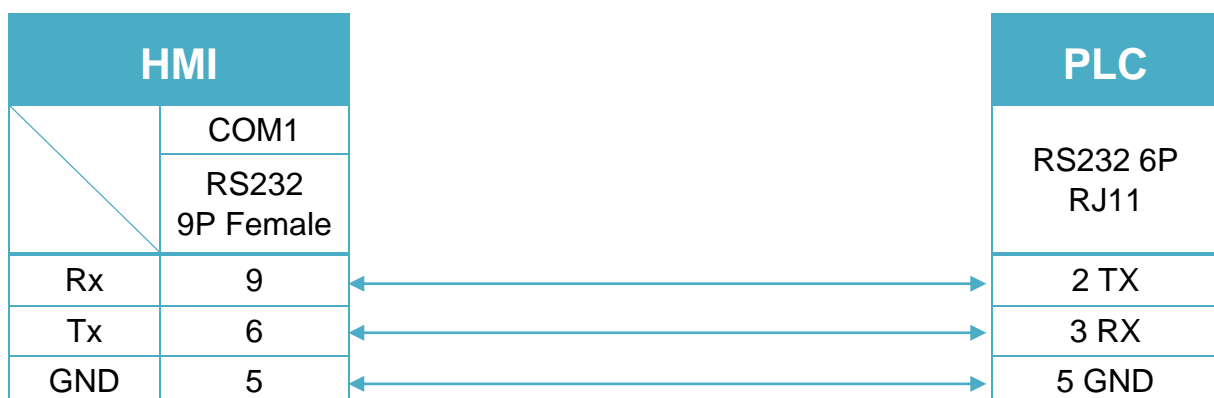


Diagram 2

cMT Series	cMT-SVR
mTV	mTV
MT-iE	MT8070iE / MT6070iE / MT8100iE / MT8121iE / MT8150iE / MT8071iE / MT6071iE / MT8072iE / MT6072iE / MT8073iE / MT8101iE / MT8102iE / MT8103iE
MT-XE	MT8121XE / MT8150XE / MT8090XE


Diagram 3

MT-iE	MT8050iE
MT-iP	MT6051iP / MT6071iP / MT8071iP



Cimon CM1-SC02A

Supported Series: Cimon CM series, SC02A module

Website: <http://www.kdtsys.com>

HMI Setting:

Parameters	Recommended	Options	Notes
PLC type	Cimon CM1-SC02A		
PLC I/F	RS232		
Baud rate	38400		
Data bits	8		
Parity	None		
Stop bits	1		
PLC sta. no.	1		

Device Address:

Bit/Word	Device type	Format	Range	Memo
B	X	DDDDh	0 ~ 1023f	0-1F Read Only
B	Y	DDDDh	0 ~ 1023f	0-F Read Only
B	M	DDDh	0 ~ 511f	
B	K	DDDh	0 ~ 127f	
B	L	DDDh	0 ~ 127f	
B	F	DDDh	0 ~ 127f	Read Only
B	T	DDDh	0 ~ 102f	
B	C	DDDh	0 ~ 102f	
W	D	DDDD	0 ~ 9999	
W	S	DD	0 ~ 99	Max. Range: 99
W	TS	DDDD	0 ~ 1023	
W	TC	DDDD	0 ~ 1023	
W	CS	DDDD	0 ~ 1023	
W	CC	DDDD	0 ~ 1023	

Wiring Diagram:

CM1-SC02A: RS-232 9P D-Sub (Diagram 1 ~ Diagram 3)

Diagram 1

cMT Series	<i>cMT3151</i>
eMT Series	<i>eMT3070 / eMT3105 / eMT3120 / eMT3150</i>
MT-iE	<i>MT8073iE / MT8102iE</i>
MT-XE	<i>MT8092XE</i>
MT-iP	<i>MT6103iP</i>

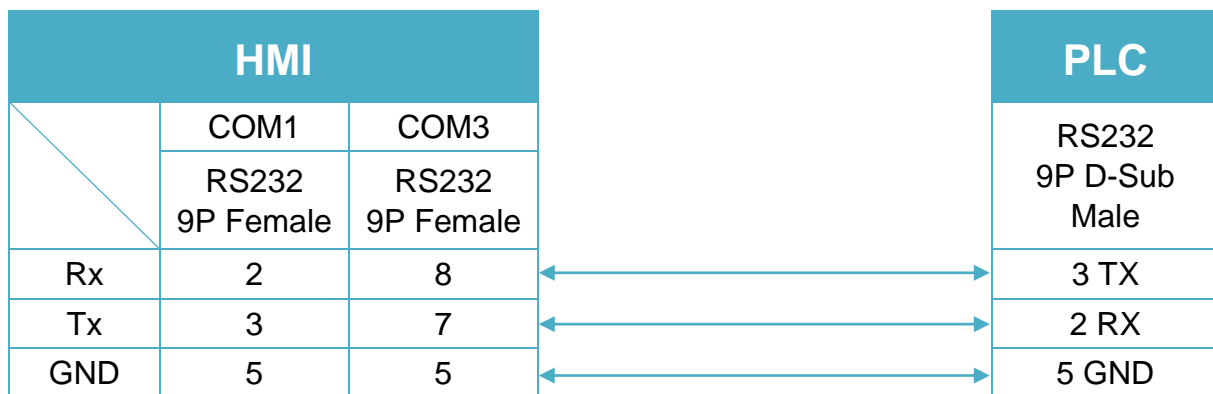


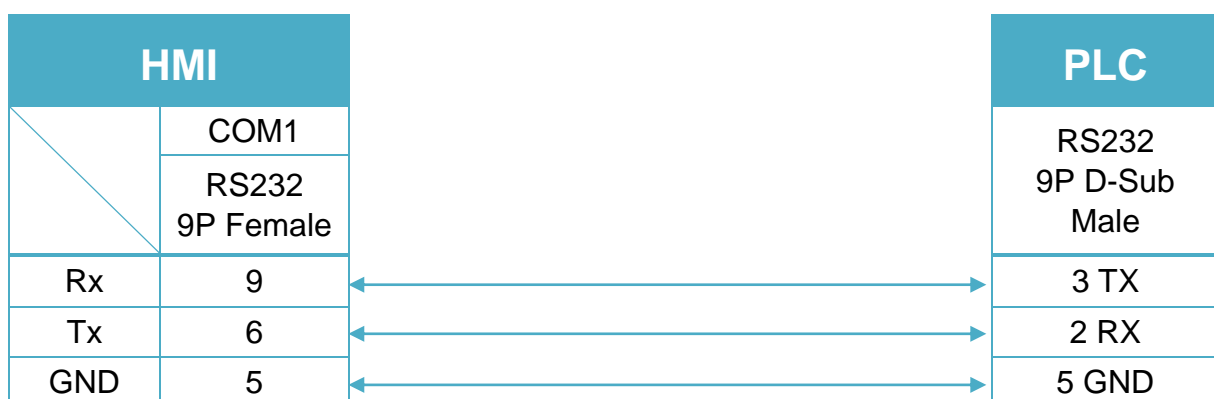
Diagram 2

cMT Series	cMT-SVR
mTV	mTV
MT-iE	MT8070iE / MT6070iE / MT8100iE / MT8121iE / MT8150iE / MT8071iE / MT6071iE / MT8072iE / MT6072iE / MT8073iE / MT8101iE / MT8102iE / MT8103iE
MT-XE	MT8121XE / MT8150XE / MT8090XE



Diagram 3

MT-iE	MT8050iE
MT-iP	MT6051iP / MT6071iP / MT8071iP



Cimon CM3-SP32MDT/SP16MDR/V/E/F(Ethernet)

Supported Series: CM3-SP32MDT/SP16MDR/V/E/F

Website: <http://www.kdtsys.com>

HMI Setting:

Parameters	Recommended	Options	Notes
PLC type	Cimon CM3-SP32MDT/SP16MDR/V/E/F(Ethernet)		
PLC I/F	Ethernet		Use UDP
Port no.	10266		

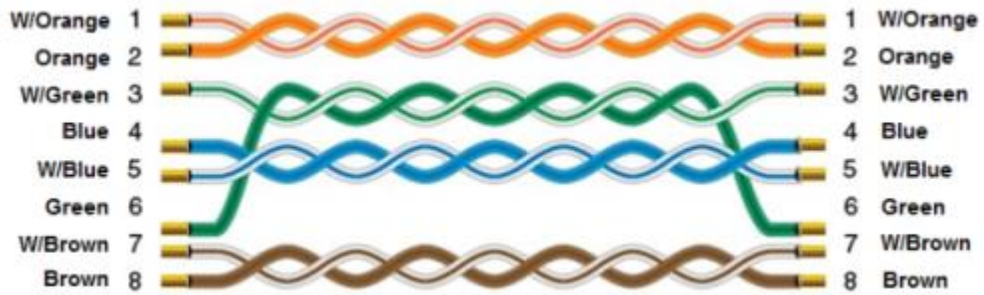
Device Address:

Bit/Word	Device type	Format	Range	Memo
B	X	DDh	0 ~ 63F	
B	Y	DDh	0 ~ 63F	
B	M	DDDh	0 ~ 511F	
B	L	DDDh	0 ~ 255F	
B	K	DDDh	0 ~ 255F	
B	F	DDDh	0 ~ 127F	
B	T	DDD	0 ~ 511	
B	C	DDD	0 ~ 511	
B	Q	DDDh	0 ~ 511F	
W	S_Bit	DDDD	0 ~ 9999	
W	S	DD	0 ~ 99	
W	R	DD	0 ~ 15	
W	D	DDDD	0 ~ 9999	
W	Z	DDDD	0 ~ 1063	
W	TC	DDDD	0 ~ 1023	
W	TS	DDDD	0 ~ 1023	
W	CC	DDDD	0 ~ 1023	
W	CS	DDDD	0 ~ 1023	

Wiring Diagram:

Diagram 1

Ethernet cable:



Cimon PLC Series (Ethernet)

Supported Series: Cimon PLC Series (Ethernet)

Website: <http://www.kdtsys.com>

HMI Setting:

Parameters	Recommended	Options	Notes
PLC type	Cimon PLC Series (Ethernet)		
PLC I/F	Ethernet		
Port no.	10260	10260(TCP) / 10262(UDP)	

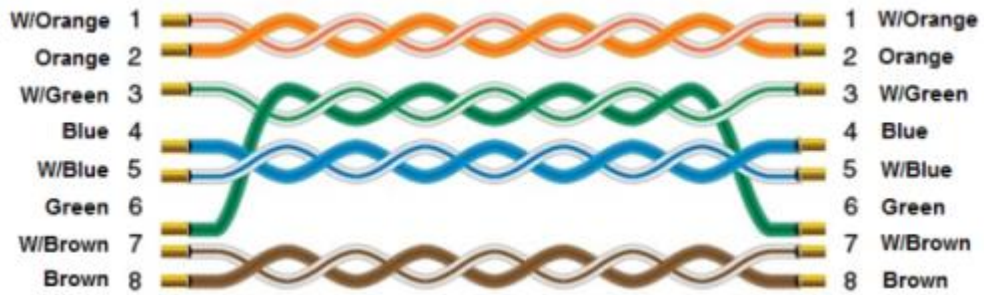
Device Address:

Bit/Word	Device type	Format	Range	Memo
B	X_Bit	DDDh	0 ~ 511F	
B	Y_Bit	DDDh	0 ~ 511F	
B	M_Bit	DDDh	0 ~ 999F	
B	K_Bit	DDDh	0 ~ 999F	
B	L_Bit	DDDh	0 ~ 999F	
B	T	DDDh	0 ~ 4095	
B	C	DDDh	0 ~ 4095	
B	F_Bit	DDDh	0 ~ 999F	
W	X	DDD	0 ~ 511	
W	Y	DDD	0 ~ 511	
W	M	DDD	0 ~ 999	
W	K	DDD	0 ~ 999	
W	L	DDD	0 ~ 999	
W	TC	DDDD	0 ~ 4095	
W	CC	DDDD	0 ~ 4095	
W	D	DDDD	0 ~ 31999	
W	F	DDD	0 ~ 127	
W	Z	DDDD	0 ~ 2047	
W	S	DD	0 ~ 99	
W	TS	DDDD	0 ~ 4095	
W	CS	DDDD	0 ~ 4095	

Wiring Diagram:

Diagram 1

Ethernet cable:



CODESYS V2 (Absolute Addressing) (Ethernet)

Supported Version: CoDeSys V2.2

HMI Setting:

Parameters	Recommended	Options	Notes
PLC type	CODESYS V2 (Absolute Addressing) (Ethernet)		
PLC I/F	Ethernet		
Port no.	1200		
PLC sta. no.	No need to set station no.		

Device Address:

Bit/Word	Device	Format	Range	Memo
B	IX	DDDDDDdd	0 ~ 6553515	
B	QX	DDDDDDdd	0 ~ 6553515	
B	MX	DDDDDDdd	0 ~ 6553515	
W	IW	OOOOOO	0 ~ 65535	
W	QW	DDDDD	0 ~ 65535	
W	MW	DDDDD	0 ~ 65535	
W	ID	DDDDD	0 ~ 65535	
W	QD	DDDDD	0 ~ 65535	
W	MD	DDDDD	0 ~ 65535	

Wiring Diagram:

Diagram 1

Ethernet cable:



CODESYS V2 (Symbolic Addressing)

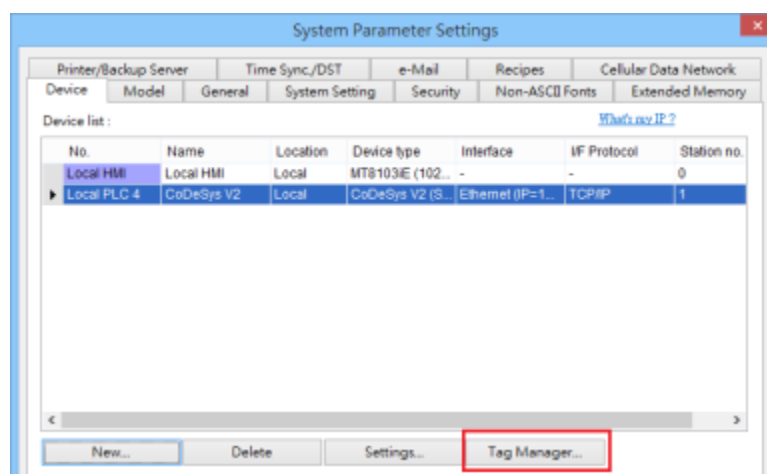
Supported Series: CODESYS V2

HMI Setting:

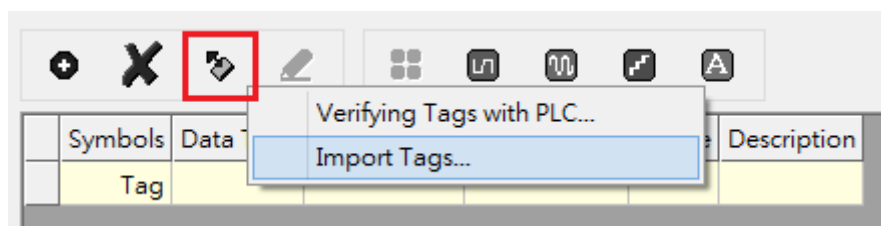
Parameters	Recommended	Options	Notes
PLC type	CODESYS V2 (Symbolic Addressing)		
PLC I/F	RS232		
Baud rate	38400		
Data bits	8		
Parity	None		
Stop bits	1		

How to Import Tags:

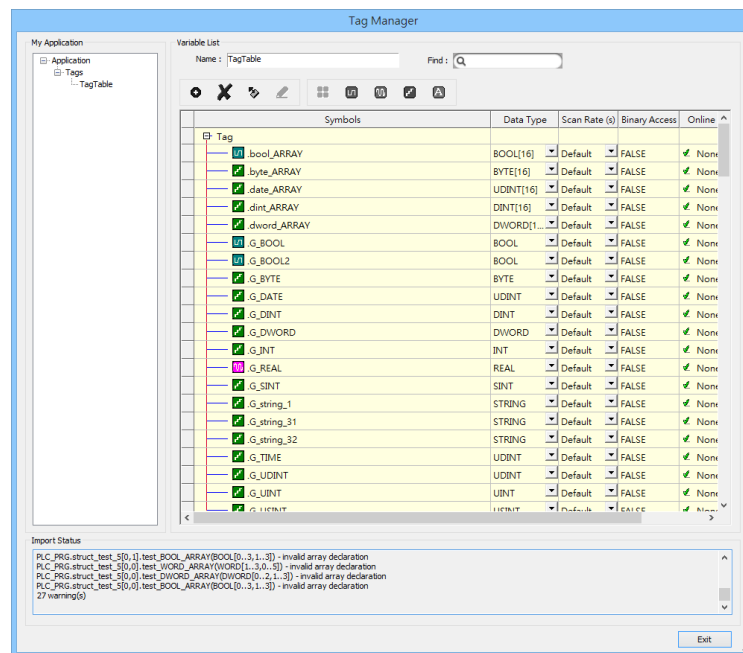
- Click **[New]** to add **[CODESYS V2 (Symbolic Addressing)]** driver, and then click **[Tag Manager]**.



- Select **[Get Tags]** » **[Import Tags]**, and then select the Tag **(.SYM_XML)** to be imported.



- The successfully imported tags will be listed in a table. If any unsupported data type exists, a warning message will show in **[Import Status]** field.



Note: Generate *.SYM_XML

- [Project]** -> **[Options]** -> **[Symbol configuration]** , select **[Dump symbol entries]** and **[Dump XML symbol table]**.
- Open **[Configure symbol file]**, select **[Export data entries]**

Wiring Diagram:

CM1-SC02A: RS-232 9P D-Sub (Diagram 1 ~ Diagram 3)

Diagram 1

cMT Series	<i>cMT3151</i>
eMT Series	<i>eMT3070 / eMT3105 / eMT3120 / eMT3150</i>
MT-iE	<i>MT8073iE / MT8102iE</i>
MT-XE	<i>MT8092XE</i>
MT-iP	<i>MT6103iP</i>

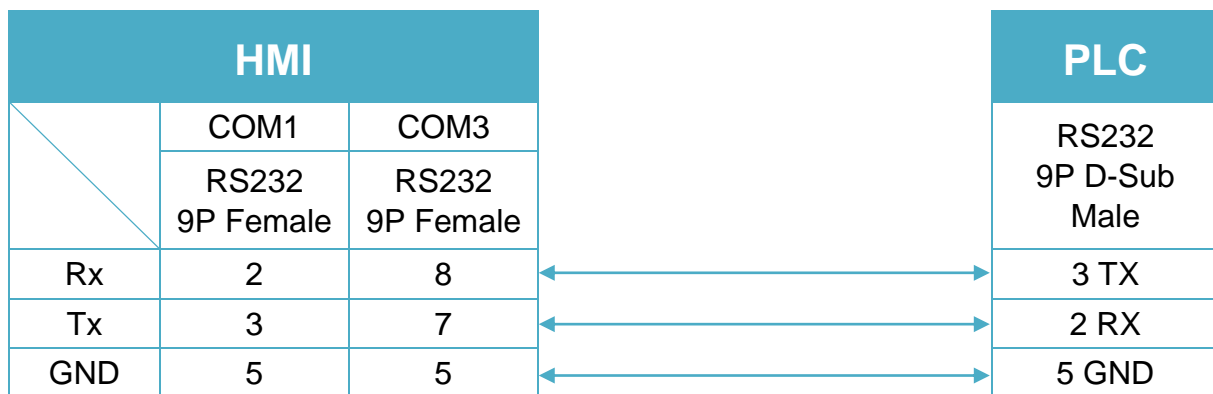


Diagram 2

cMT Series	cMT-SVR
mTV	mTV
MT-iE	MT8070iE / MT6070iE / MT8100iE / MT8121iE / MT8150iE / MT8071iE / MT6071iE / MT8072iE / MT6072iE / MT8073iE / MT8101iE / MT8102iE / MT8103iE
MT-XE	MT8121XE / MT8150XE / MT8090XE

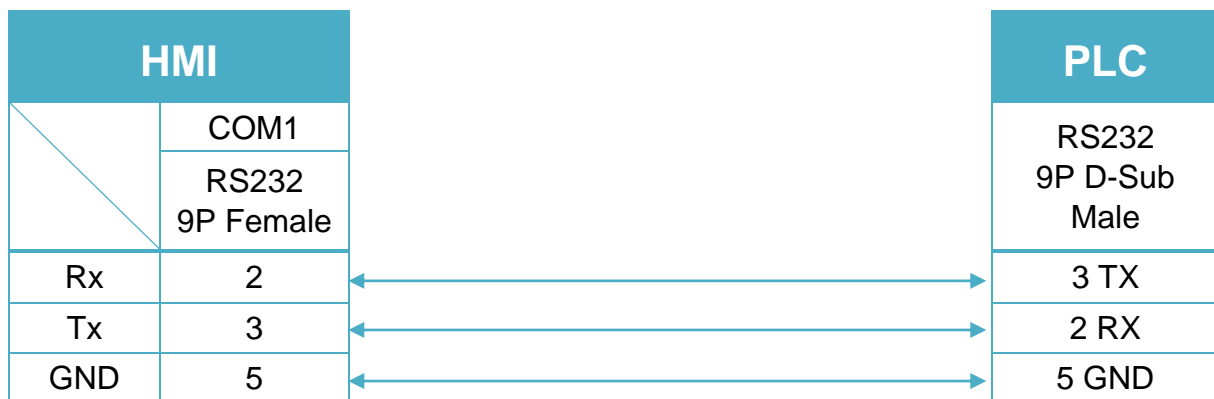
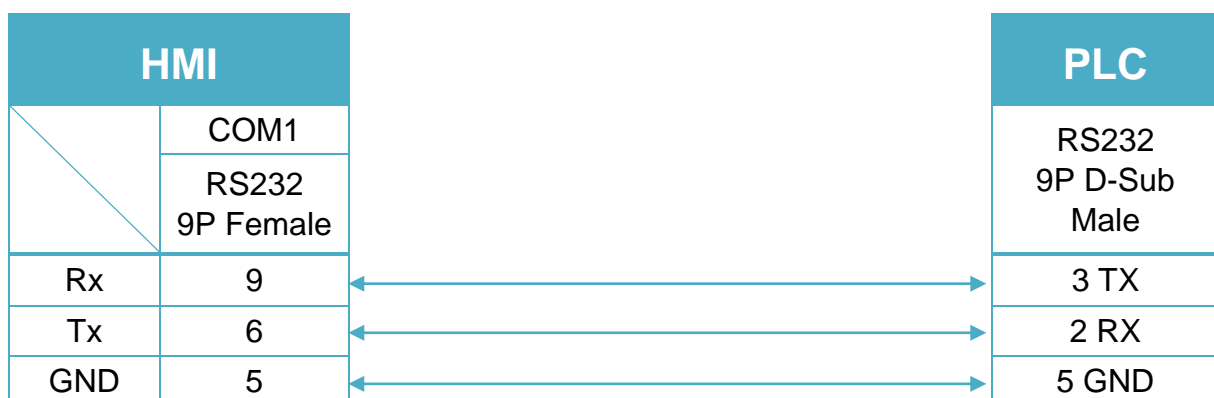


Diagram 3

MT-iE	MT8050iE
MT-iP	MT6051iP / MT6071iP / MT8071iP



CODESYS V2 (Symbolic Addressing) (Ethernet)

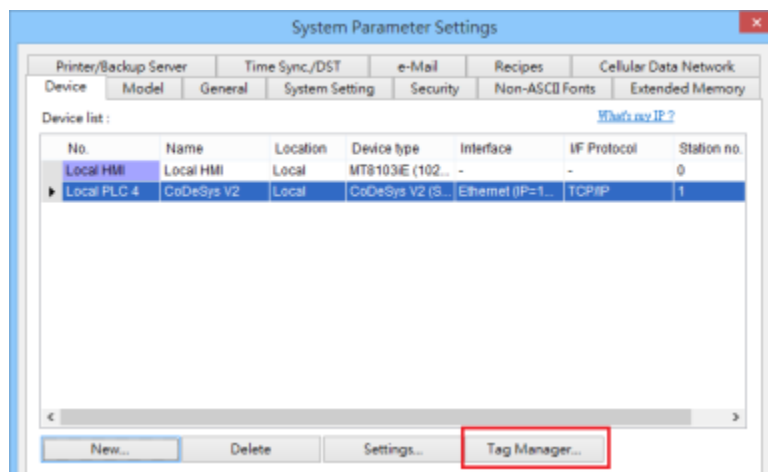
Supported series: CODESYS V2

HMI Setting:

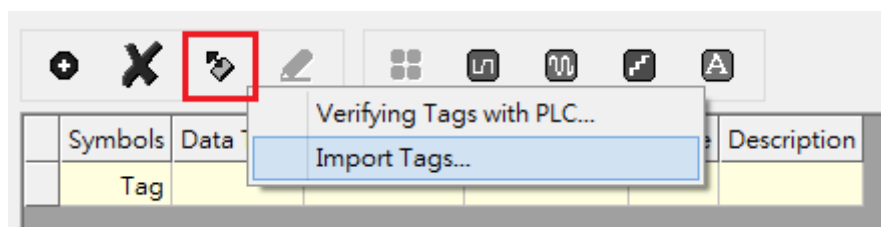
Parameters	Recommended	Options	Notes
PLC type	CODESYS V2 (Symbolic Addressing) (Ethernet)		
PLC I/F	Ethernet		
Port no.	1200		
Protocol	TCP/IP	TCP/IP, TCP/IP[Level 2]	

How to Import Tags:

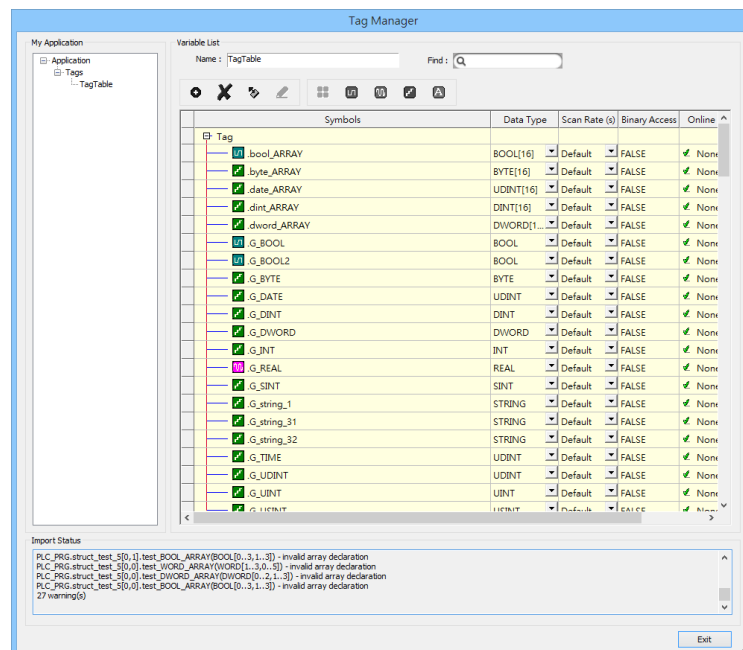
- Click **[New]** to add **[CODESYS V2 (Symbolic Addressing) (Ethernet)]** driver, and then click **[Tag Manager]**.



- Select **[Get Tags]** » **[Import Tags]**, and then select the Tag **(.SYM_XML)** to be imported.

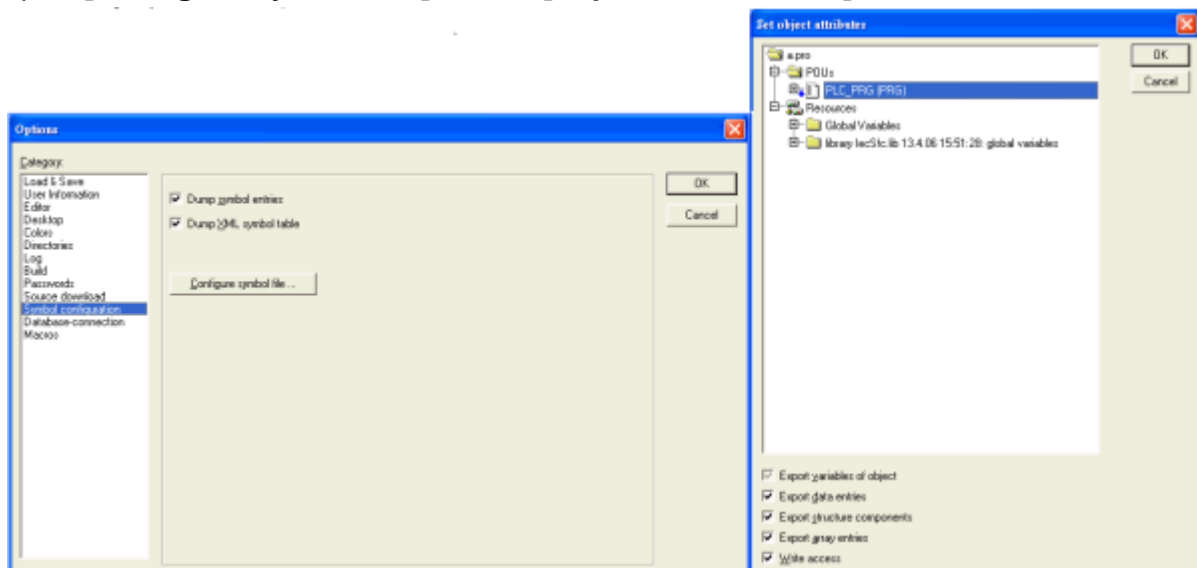


- The successfully imported tags will be listed in a table. If any unsupported data type exists, a warning message will show in **[Import Status]** field.



Note: Generate *.SYM_XML

- [Project]** -> **[Options]** -> **[Symbol configuration]** , select **[Dump symbol entries]** and **[Dump XML symbol table]**.
- Open **[Configure symbol file]**, select **[Export data entries]**



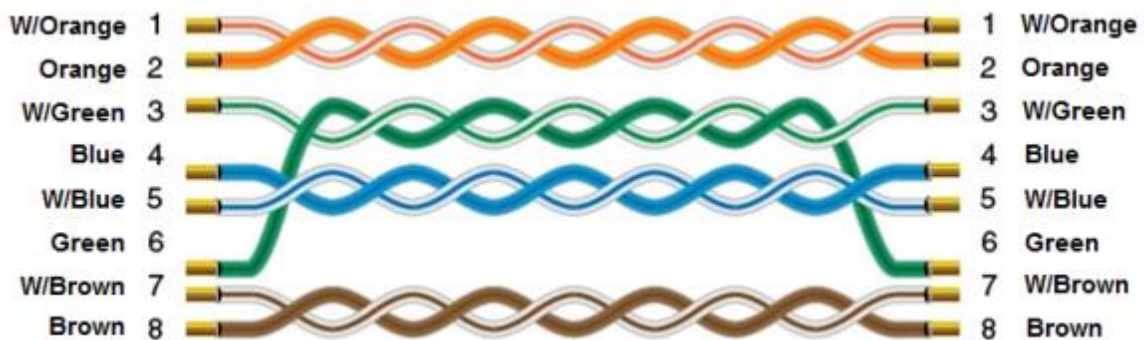
Support Device Type:

S7-1200 data type	EasyBuilder data format	Memo
Bool	bit	
Byte	16-bit BCD, Hex, Binary, Unsigned	8-bit
SInt	16-bit BCD, Hex, Binary, Signed	8-bit
USInt	16-bit BCD, Hex, Binary, Unsigned	8-bit
Word	16-bit BCD, Hex, Binary, Unsigned	16-bit
Int	16-bit BCD, Hex, Binary, Signed	16-bit
UInt	16-bit BCD, Hex, Binary, Unsigned	16-bit
DWord	32-bit BCD, Hex, Binary, Unsigned	32-bit
DInt	32-bit BCD, Hex, Binary, Signed	32-bit
Real	32-bit Float	32-bit
UDInt	32-bit BCD, Hex, Binary, Unsigned	32-bit
String	Word array for ASCII input and display	Length=word

Wiring Diagram:

Diagram 1

Ethernet cable:



CODESYS V3 (Ethernet)

Supported series: LTI MOTION MO CM-3, MO CM-6, CODESYS V3

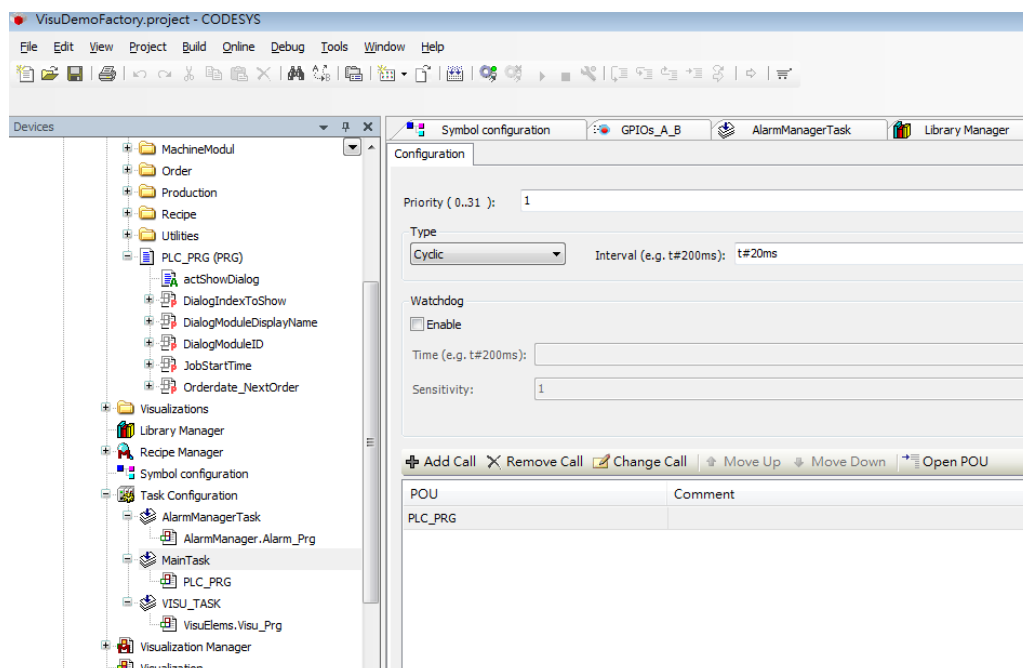
Website: <http://www.lti-motion.com/>

HMI Setting:

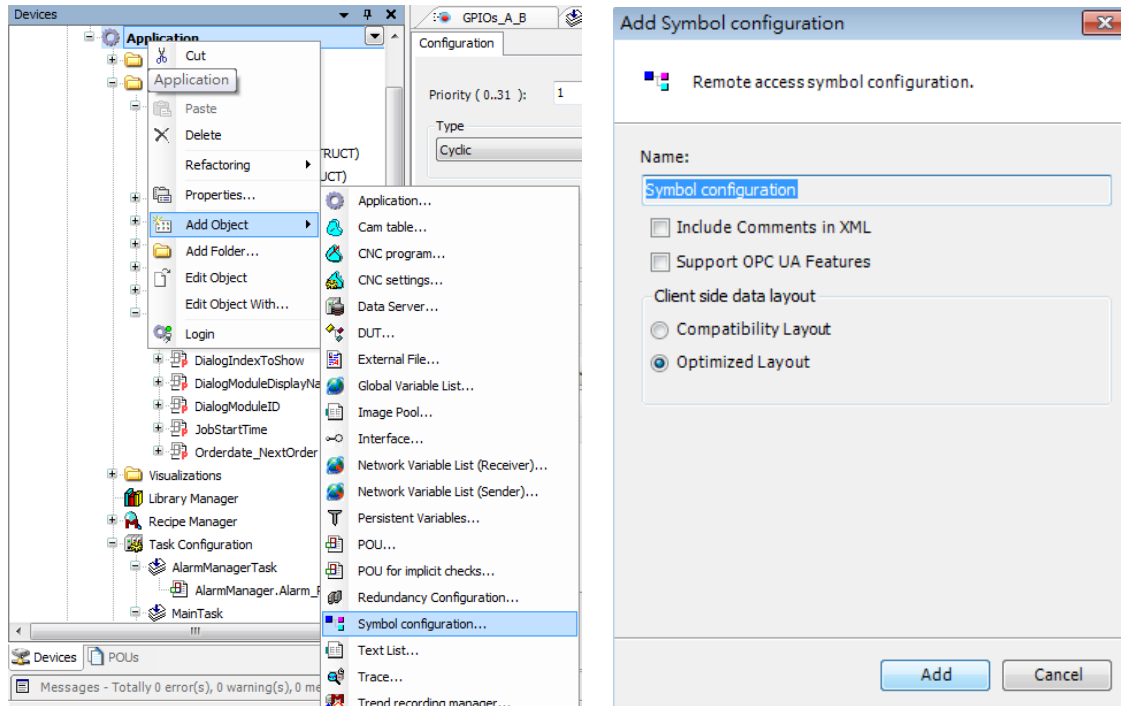
Parameters	Recommended	Options	Notes
PLC type	CODESYS V3 (Ethernet)		
PLC I/F	Ethernet		
Port no.	1740		
Source port	1742		
Protocol	V3 UDP/IP	UDP/IP ; TCP/IP	

How to Import Tags:

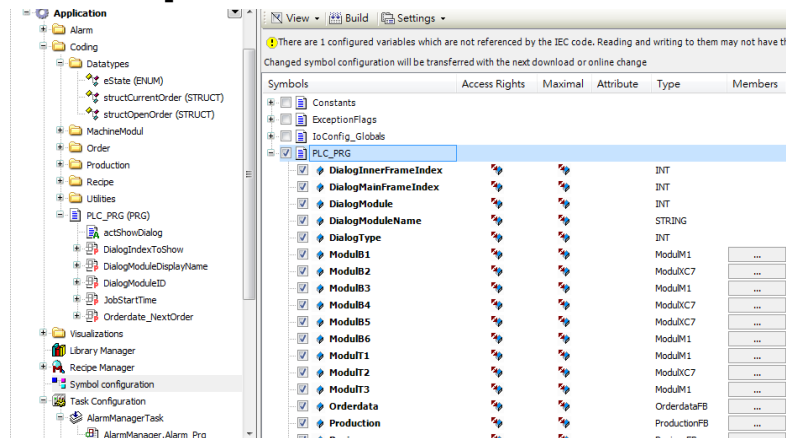
1. Under “MainTask” set POU PLC_PRG.



2. Add “Symbol configuration” into Devices list.



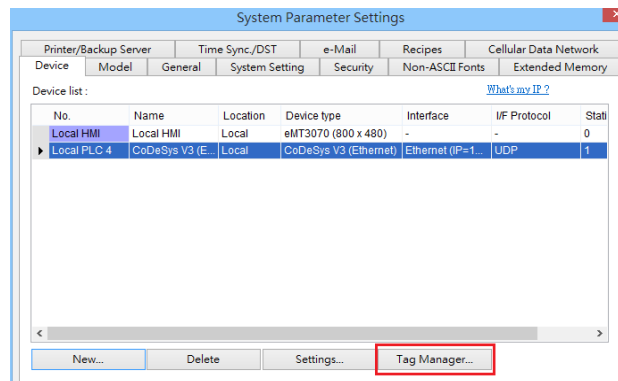
3. Select PLC_RPG and its tag information is shown, build the project. [build] -> [Generate Code]



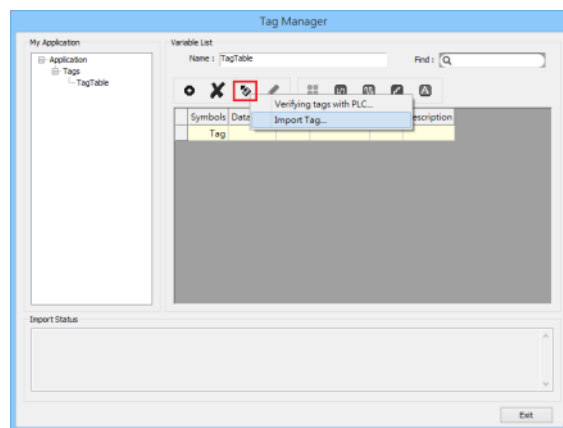
4. A *.xml file is generated in the directory of the project.

VisuDemoFactory.Device.Application.77b33013-b5cd-4...	2016/4/29 11:36	BOOTINFO 檔案	43,347 KB
VisuDemoFactory.Device.Application.77b33013-b5cd-4...	2016/4/29 11:36	BOOTINFO_GUL...	1 KB
VisuDemoFactory.Device.Application.77b33013-b5cd-4...	2016/4/29 11:36	COMPILEINFO 檔...	43,347 KB
VisuDemoFactory.Device.Application.xml	2016/4/29 11:36	XML Document	29 KB
VisuDemoFactory.project	2016/4/29 19:26	CODESYS project	1,362 KB
VisuDemoFactory.project.~u	2016/5/4 11:17	~U 檔案	1 KB
VisuDemoFactory-admin-Weintek-RD-APP1.opt	2016/4/29 19:26	OPT 檔案	81 KB
VisuDemoFactory-AllUsers.opt	2016/4/29 19:26	OPT 檔案	1 KB

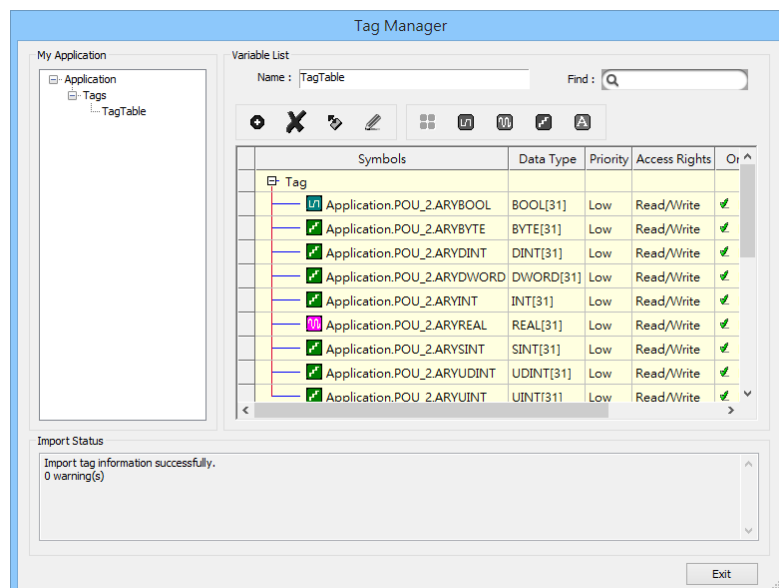
5. In System Parameter Settings click **[New]** to add CoDeSys V3 (Ethernet) driver into the device list and then click **[Tag Manager]**.



6. In Tag Manager click **Get tag -> Import Tag**, and then select the tag file (.xml) generated by the PLC software.



7. When the tags are imported successfully, click **[Exit]** to leave.



Support Device Type:

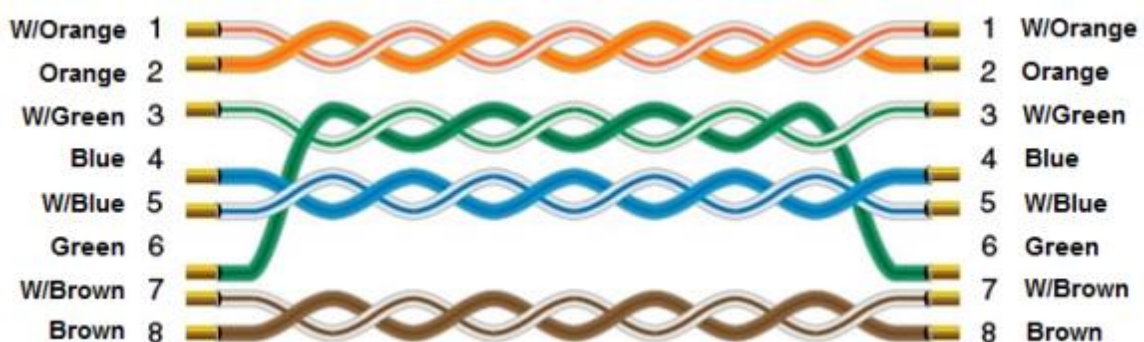
Data type	EasyBuilder data format	Memo
Bool	bit	
Byte	16-bit BCD, Hex, Binary, Unsigned	8-bit
SInt	16-bit BCD, Hex, Binary, Signed	8-bit
USInt	16-bit BCD, Hex, Binary, Unsigned	8-bit
Word	16-bit BCD, Hex, Binary, Unsigned	16-bit
Int	16-bit BCD, Hex, Binary, Signed	16-bit
UInt	16-bit BCD, Hex, Binary, Unsigned	16-bit
DWord	32-bit BCD, Hex, Binary, Unsigned	32-bit
DInt	32-bit BCD, Hex, Binary, Signed	32-bit
Real	32-bit Float	32-bit
UDInt	32-bit BCD, Hex, Binary, Unsigned	32-bit
String	Word array for ASCII input and display	Length=word

String length must be set identical to the length in Codesys software.

Wiring Diagram:

Diagram 1

Ethernet cable:



Control Techniques SI-Ethernet Modbus TCP/IP

Supported Series: Unidrive M400 and SI Ethernet Module

Website: <http://www.nidec.com/en-Global/>

HMI Setting:

Parameters	Recommended	Options	Notes
PLC type	Control Techniques SI-Ethernet Modbus TCP/IP		
PLC I/F	Ethernet		
Port no.	502		
Address mode	Standard	Standard / Modified	

Device Address:

Bit/Word	Device type	Format	Range	Memo
B	BIT	SSS.MM.PPP	0 ~ 255.99.999	Slot.Menu.Parameter
Byte	BYTE	SSS.MM.PPP	0 ~ 255.99.999	Slot.Menu.Parameter
W	WORD	SSS.MM.PPP	0 ~ 255.99.999	Slot.Menu.Parameter
DW	DWORD	SSS.MM.PPP	0 ~ 255.99.999	Slot.Menu.Parameter

*The standard addressing mode allows parameters up to 99 to be accessed, for any parameter above 99, the modified addressing mode must be used, however, this mode limits the highest accessible menu number to 63.

S.15.013	Modbus Register Addressing Mode			Memo
Minimum	0 (standard)	Maximum	1 (Modified)	8 Bit User Save

Wiring Diagram:

Diagram 1

Ethernet cable:



Control Technology 2500 Series

Supported Series: CTI 2500 Series PLCs (Classic and Compact): C100, C200, C300 and C400.

Website: <http://www.controltechnology.com/>

HMI Setting:

Parameters	Recommended	Options	Notes
PLC type	Control Technology 2500 Series		NITP protocol
PLC I/F	RS232	RS232, RS485 4W	
Baud rate	19200	19200	
Data bits	7	7	
Parity	Odd	Odd	
Stop bits	1	1	
PLC sta. no.	0	Does not apply	

Device Address:

Bit/Word	Device type	Format	Range	Memo
B	CR	DDDDD	1 ~ 65535	Internal Relay
B	X	DDDDD	1 ~ 65535	Discrete Input Coils
B	Y	DDDDD	1 ~ 65535	Discrete Output Coils
B	V_Bit	DDDDDdd	101 ~ 6553616	User Data Register Bits
W	V	DDDDD	1 ~ 65535	User Data Registers
DW	VD	DDDDD	1 ~ 65536	User Data Registers (32bit)
W	STW	DDDDD	1 ~ 65535	Status Word Registers
W	TCP	DDDDD	1 ~ 65535	Timer/Counter Preset Values
W	TCC	DDDDD	1 ~ 65535	Timer/Counter Current Values
W	WX	DDDDD	1 ~ 65535	Word Discrete Inputs
W	WY	DDDDD	1 ~ 65535	Word Discrete Outputs

Wiring Diagram:

RS232 9P D-Sub (Diagram 1 ~ Diagram 3)

Diagram 1

cMT Series	<i>cMT3151</i>
eMT Series	<i>eMT3070 / eMT3105 / eMT3120 / eMT3150</i>
MT-iE	<i>MT8073iE / MT8102iE</i>
MT-XE	<i>MT8092XE</i>
MT-iP	<i>MT6103iP</i>



Diagram 2

cMT Series	<i>cMT-SVR</i>
mTV	<i>mTV</i>
MT-iE	<i>MT8070iE / MT6070iE / MT8100iE / MT8121iE / MT8150iE / MT8071iE / MT6071iE / MT8072iE / MT6072iE / MT8073iE / MT8101iE / MT8102iE / MT8103iE</i>
MT-XE	<i>MT8121XE / MT8150XE / MT8090XE</i>

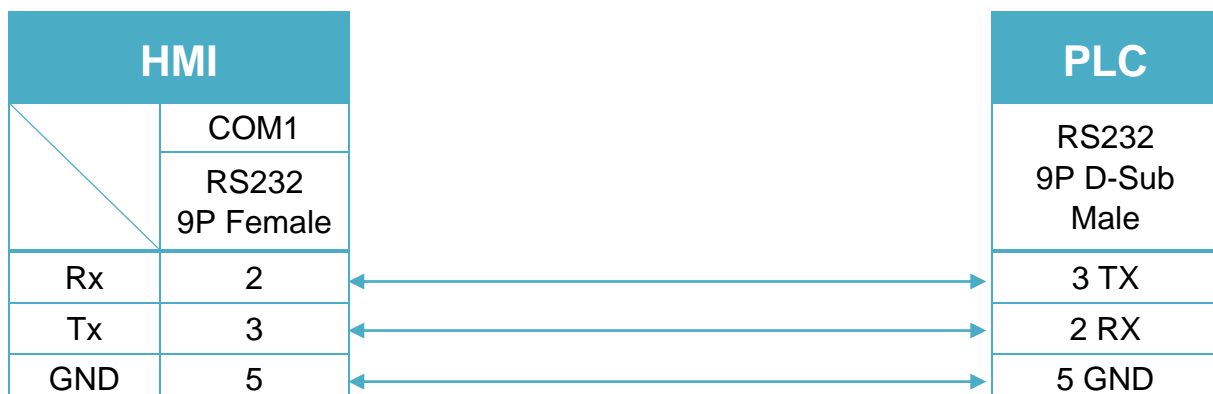
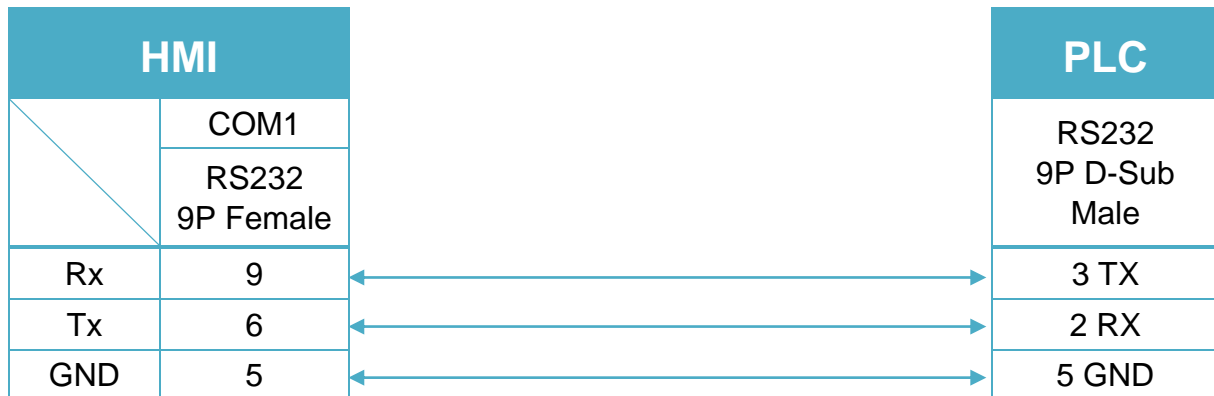


Diagram 3

MT-iE	MT8050iE
MT-iP	MT6051iP / MT6071iP / MT8071iP



RS485 4W 9P D-Sub (Diagram 4 ~ Diagram 7)

Diagram 4

cMT Series	cMT3151
eMT Series	eMT3070 / eMT3105 / eMT3120 / eMT3150
MT-iE	MT8070iE / MT6070iE / MT8100iE / MT8121iE / MT8150iE
MT-XE	MT8121XE / MT8150XE

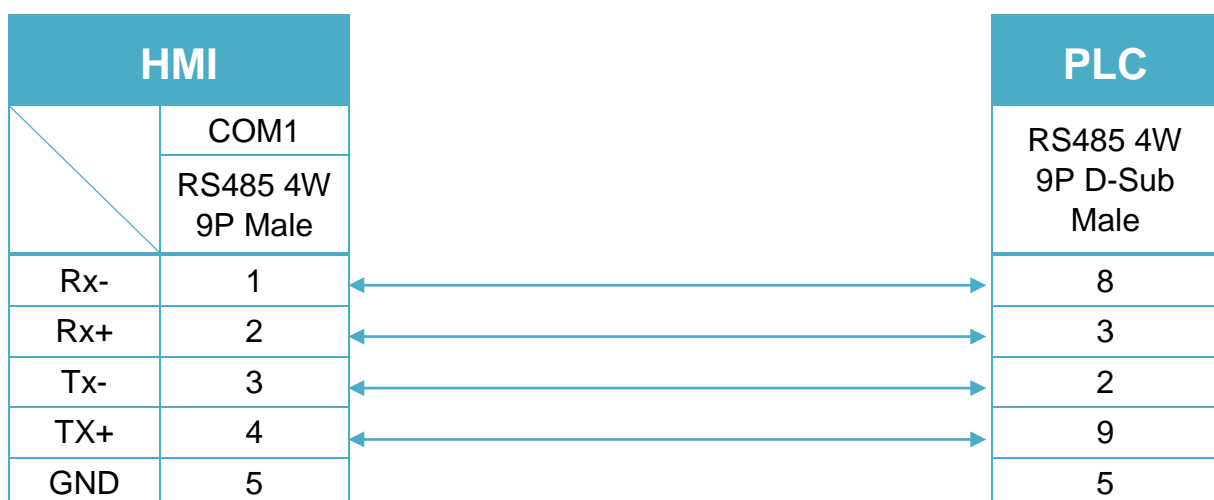


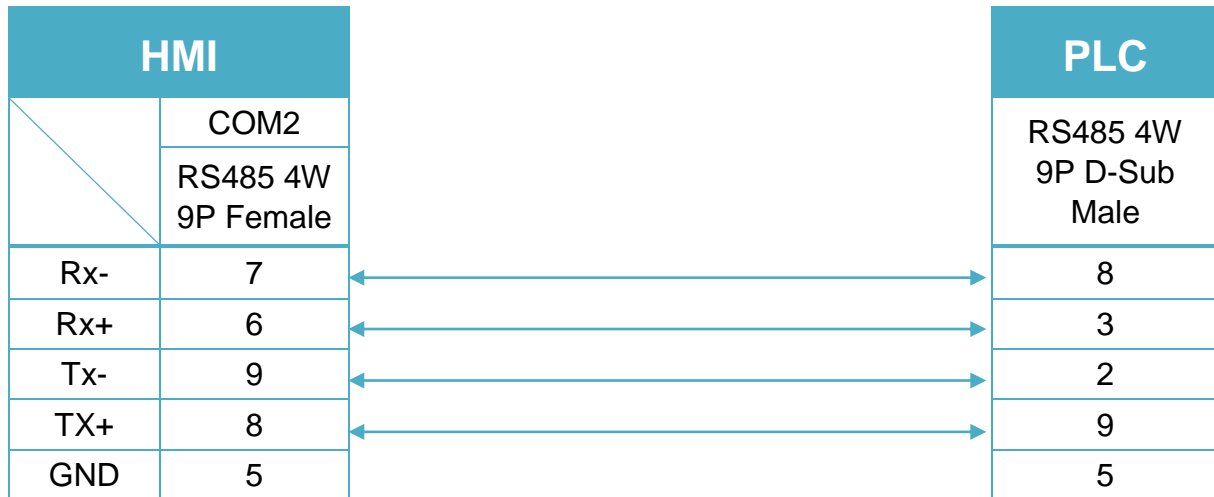
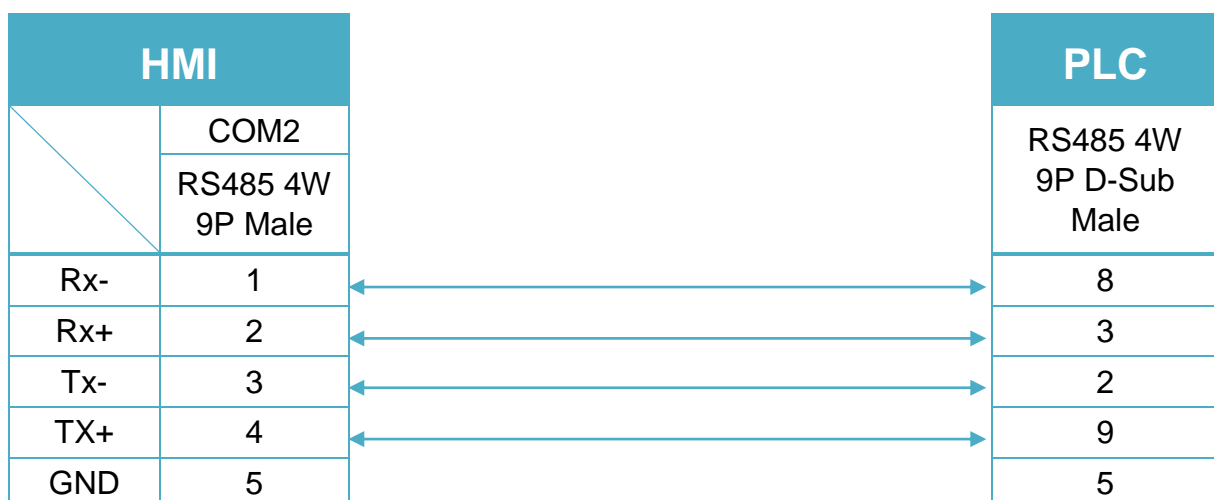
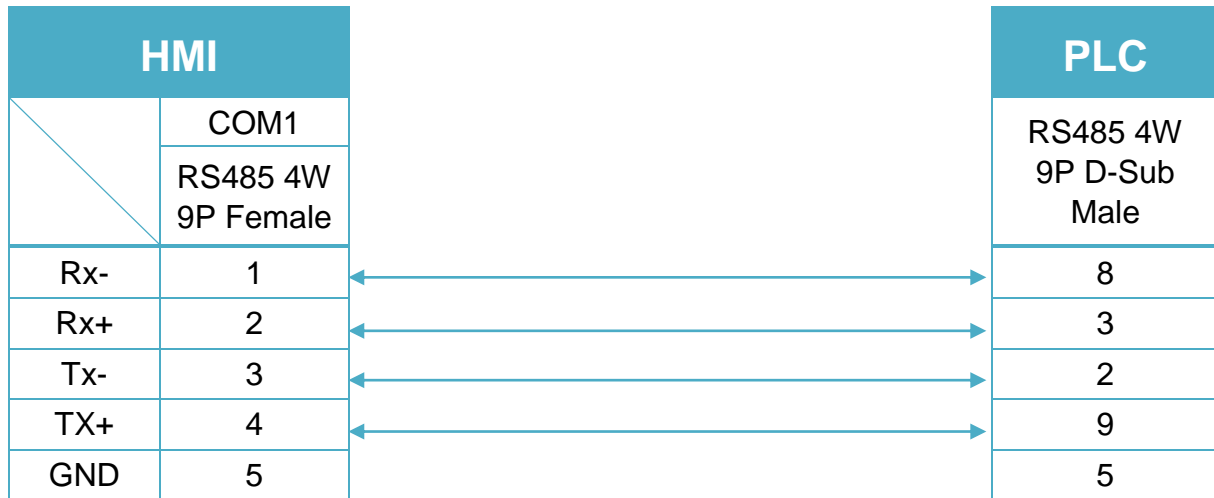
Diagram 5
cMT Series
cMT-SVR
mTV
mTV

Diagram 6
MT-iE
***MT8071iE / MT6071iE / MT8072iE / MT6072iE / MT8073iE /
MT8101iE / MT8102iE / MT8103iE***
MT-XE
MT8090XE / MT8092XE
MT-iP
MT6071iP / MT8071iP / MT6103iP


Diagram 7

MT-iE *MT8050iE*

MT-iP *MT6051iP*



Control Technology 2500 Series (Ethernet)

Supported Series: CTI 2500 Series PLCs (Classic and Compact): C100, C200, C300 and C400

Website: <http://www.controltechnology.com/>

HMI Setting:

Parameters	Recommended	Options	Notes
PLC type	Control Technology 2500 Series (Ethernet)		
PLC I/F	Ethernet		
Port no.	1505		
PLC sta. no.	1		

Device Address:

Bit/Word	Device type	Format	Range	Memo
B	CR	DDDDD	1 ~ 65536	Internal Relay
B	X	DDDDD	1 ~ 65536	Discrete Input Coils
B	Y	DDDDD	1 ~ 65536	Discrete Output Coils
B	V_Bit	DDDDDdd	101 ~ 6553616	User Data Register Bits
W	V	DDDDD	1 ~ 65536	User Data Registers
DW	VD	DDDDD	1 ~ 65535	User Data Registers (32bit)
W	STW	DDDDD	1 ~ 65536	Status Word Registers
W	TCP	DDDDD	1 ~ 65536	Timer/Counter Preset Values
W	TCC	DDDDD	1 ~ 65536	Timer/Counter Current
W	WX	DDDDD	1 ~ 65536	Word Discrete Inputs
W	WY	DDDDD	1 ~ 65536	Word Discrete Outputs

Wiring Diagram:

Ethernet cable:



Copley Digital Drives

Supported Series: Digital Servo Driver & Controllers, Xenus, Xenus Micro, Accelnet, Accelnet Micro, Stepnet series.

Website: <http://www.copleycontrols.com/>

HMI Setting:

Parameters	Recommended	Options	Notes
PLC type	Copley Digital Drives		
PLC I/F	RS232		
Baud rate	9600	9600~115200	
Data bits	8	8	
Parity	None	Even, Odd, None	
Stop bits	1	1	
HMI sta. no.	0		
PLC sta. no.	0	0-127	

Device Address:

Bit/Word	Device type	Format	Range	Memo
W	Flash INT 16	HHH	0 ~ 999	For Register is INT16 or U16
W	RAM INT 16	HHH	0 ~ 999	For Register is INT16 or U16
W	Flash INT 32	HHH	0 ~ 999	For Register is INT32 or U32
W	RAM INT 32	HHH	0 ~ 999	For Register is INT32 or U32
W	Register	DDDD	0 ~ 2457	
W	T_command	H	0	
W	Reset	H	0	
W	Flash_INT16_B	HHH	0 ~ 999	
W	RAM_INT16_B	HHH	0 ~ 999	
W	Flash_INT32_B	HHH	0 ~ 999	
W	RAM_INT32_B	HHH	0 ~ 999	
W	Register_B	DDDD	0 ~ 2457	
W	T_command_B	H	0	
W	Reset_B	H	0	
W	Flash_INT16_C	HHH	0 ~ 999	
W	RAM_INT16_C	HHH	0 ~ 999	
W	Flash_INT32_D	HHH	0 ~ 999	
W	RAM_INT32_D	HHH	0 ~ 999	

Bit/Word	Device type	Format	Range	Memo
W	Register_D	DDDD	0 ~ 2457	
W	T_command_D	H	0	
W	Reset_D	H	0	

Wiring Diagram:

Xenus, Xenus Micro, Accelnet, Stepnet: RS-232 6P RJ11 (Diagram 1 ~ Diagram 3)

Diagram 1

cMT Series	<i>cMT3151</i>
eMT Series	<i>eMT3070 / eMT3105 / eMT3120 / eMT3150</i>
MT-iE	<i>MT8073iE / MT8102iE</i>
MT-XE	<i>MT8092XE</i>
MT-iP	<i>MT6103iP</i>

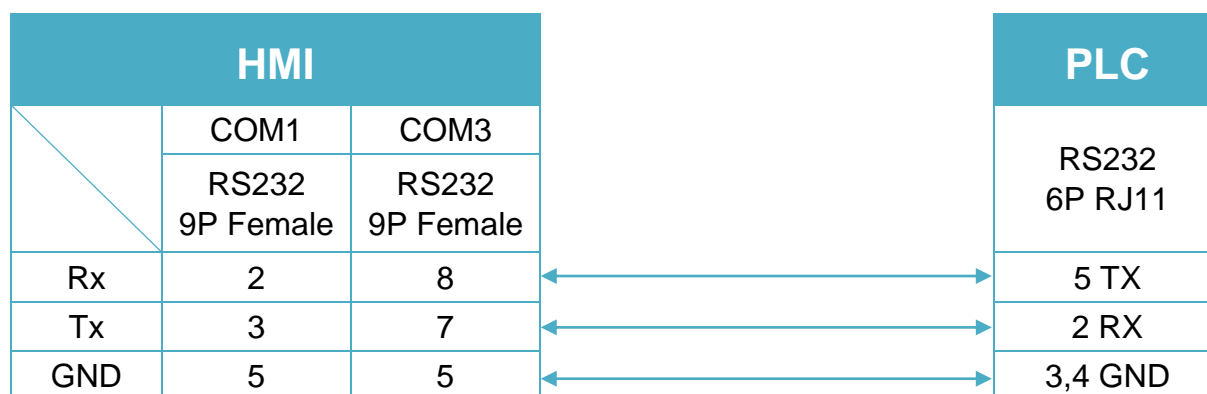


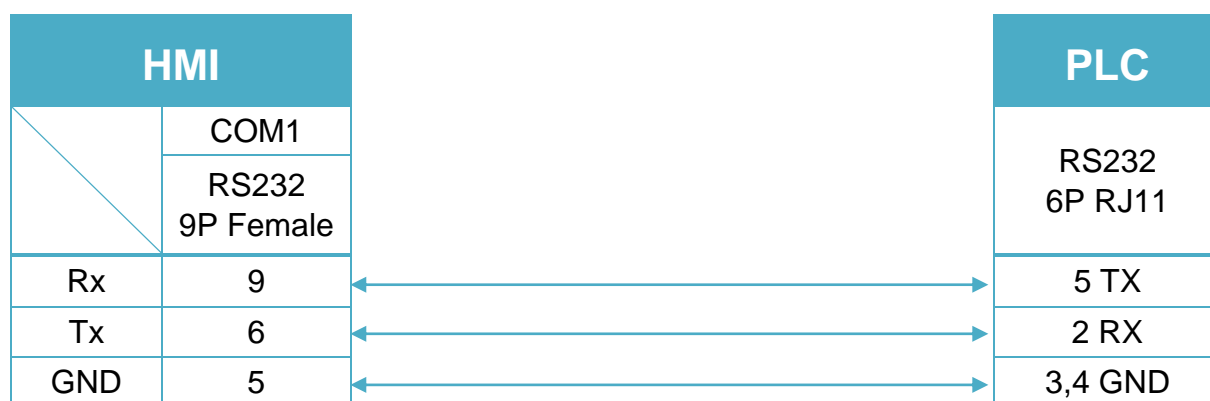
Diagram 2

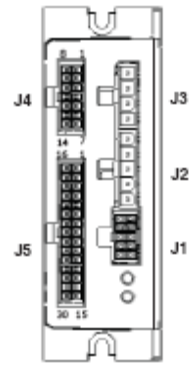
cMT Series	cMT-SVR
mTV	mTV
MT-iE	MT8070iE / MT6070iE / MT8100iE / MT8121iE / MT8150iE / MT8071iE / MT6071iE / MT8072iE / MT6072iE / MT8073iE / MT8101iE / MT8102iE / MT8103iE
MT-XE	MT8121XE / MT8150XE / MT8090XE



Diagram 3

MT-iE	MT8050iE
MT-iP	MT6051iP / MT6071iP / MT8071iP





Accelnet Micro: RS-232 J5 Cable Connector (Diagram 4 ~ Diagram 6)

Diagram 4

cMT Series	<i>cMT3151</i>
eMT Series	<i>eMT3070 / eMT3105 / eMT3120 / eMT3150</i>
MT-iE	<i>MT8073iE / MT8102iE</i>
MT-XE	<i>MT8092XE</i>
MT-iP	<i>MT6103iP</i>

HMI			PLC
	COM1	COM3	RS232 J5 Cable Connector
	RS232 9P Female	RS232 9P Female	
Rx	2	8	29 TX
Tx	3	7	14 RX
GND	5	5	15 GND

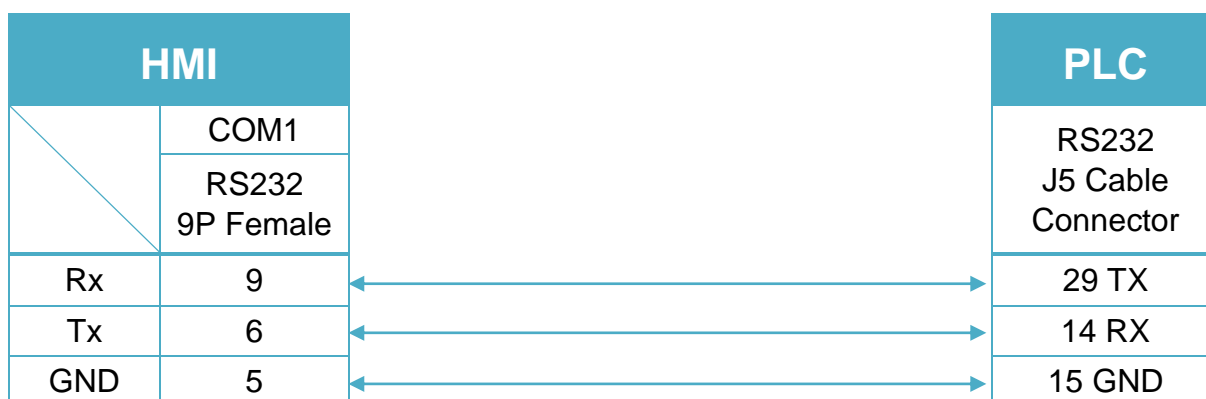
Diagram 5

cMT Series	<i>cMT-SVR</i>
mTV	<i>mTV</i>
MT-iE	<i>MT8070iE / MT6070iE / MT8100iE / MT8121iE / MT8150iE / MT8071iE / MT6071iE / MT8072iE / MT6072iE / MT8073iE / MT8101iE / MT8102iE / MT8103iE</i>
MT-XE	<i>MT8121XE / MT8150XE / MT8090XE</i>



Diagram 6

MT-iE	<i>MT8050iE</i>
MT-iP	<i>MT6051iP / MT6071iP / MT8071iP</i>



CO-TRUST CTH300-H (Ethernet)

Supported Series: CO-TRUST CTH300-H35

Website: <http://www.co-trust.com/cn/index.php>

HMI Setting:

Parameters	Recommended	Options	Notes
PLC type	CO-TRUST CTH300-H (Ethernet)		Use UDP
PLC I/F	Ethernet		
Port no.	1024		
PLC sta. no.	0		

Device Address:

Bit/Word	Device type	Format	Range	Memo
B	I	DDDDo	0 ~ 40957	Input (I)
B	Q	DDDDo	0 ~ 40957	Output (O)
B	M	DDDDo	0 ~ 40957	Bit Memory
B	VW_Bit	DDDDDo	0 ~ 102397	V Memory Bit Address
B	S	DDDDo	0 ~ 40957	SCR
B	SM	DDDDo	0 ~ 40957	Special Memory
B	T_Bit	DDDD	0 ~ 1023	Timer
B	C_Bit	DDDD	0 ~ 1023	Counter
B	DBnBit	FFFDDDDDo	0 ~ 255655357	
Byte	VB	DDDDD	0 ~ 10239	
W	VW	DDDDD	0 ~ 10239	V Memory
W	VW_Odd	DDDDD	0 ~ 10239	V Memory
W	VW_String	DDDDD	0 ~ 10239	String
W	VW_String_Odd	DDDDD	0 ~ 10239	String
DW	VD	DDDDD	0 ~ 10239	V Memory Double
DW	VD_Odd	DDDDD	0 ~ 10239	V Memory Double
DW	VD_String	DDDDD	0 ~ 10239	String
DW	VD_String_Odd	DDDDD	0 ~ 10239	String
Byte	MB	DDDDD	0 ~ 10239	Byte Memory
W	MW	DDDDD	0 ~ 10239	Word Memory
W	MW_Odd	DDDDD	0 ~ 10239	Word Memory
DW	MD	DDDDD	0 ~ 10239	Word Memory

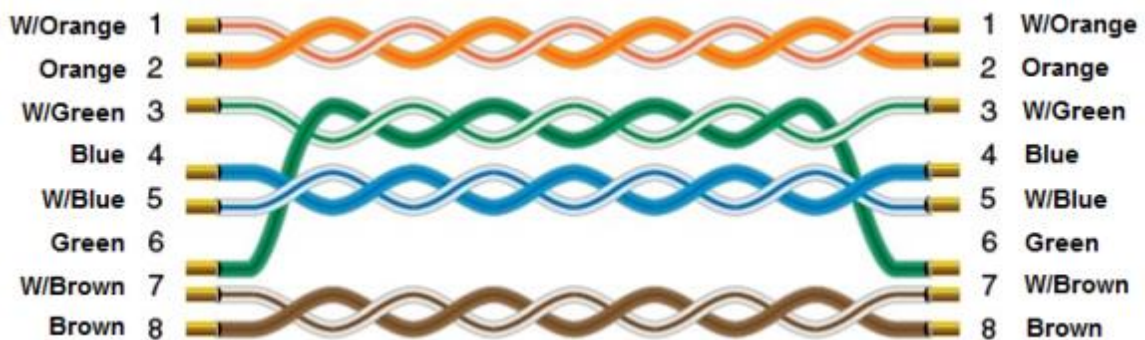
Bit/Word	Device type	Format	Range	Memo
Byte	SB	DDDDD	0 ~ 10239	SCR
W	SW	DDDDD	0 ~ 10239	SCR
DW	SD	DDDDD	0 ~ 10239	SCR
Byte	SMB	DDDDD	0 ~ 10239	Special Memory
W	SMW	DDDDD	0 ~ 10239	Special Memory
DW	SMD	DDDDD	0 ~ 10239	Special Memory
W	T	DDD	0 ~ 1023	Timer
W	C	DDD	0 ~ 1023	Counter
Byte	DBBn	FFFDDDDD	0 ~ 25565535	
W	DBn	FFFDDDDD	0 ~ 25565535	
DW	DBDn	FFFDDDDD	0 ~ 25565535	
D	DBn_STRINGCHAR	FFFDDDDD	0 ~ 25565535	

- Double Word and floating point value must use VD device type.

Wiring Diagram:

Diagram 1

Ethernet cable:



CO-TRUST CTH300-H PPI

Supported Series: CO-TRUST CTH300-H35

Website: <http://www.co-trust.com/cn/index.php>

HMI Setting:

Parameters	Recommended	Options	Notes
PLC type	CO-TRUST CTH300-H PPI		
PLC I/F	RS485 2W	RS485 2W	
Baud rate	9600	9600, 19200, 187.5K	
Data bits	8	7,8	
Parity	Even	Even, Odd, None	
Stop bits	1	1, 2	
Turn around delay	5		
ACK delay time (ms)	30		
PLC sta. no.	2	1 ~ 126	

Online simulator	YES	Extend address mode	YES
Broadcast	NO		

PLC Setting:

PLC setting	PLC sta. no. can not be the same as HMI sta. no.
-------------	--

Device Address:

Bit/Word	Device type	Format	Range	Memo
B	I	DDDDo	0 ~ 40957	Input (I)
B	Q	DDDDo	0 ~ 40957	Output (O)
B	M	DDDDo	0 ~ 40957	Bit Memory
B	VW_Bit	DDDDDo	0 ~ 102397	V Memory Bit Address
B	S	DDDDo	0 ~ 40957	SCR
B	SM	DDDDo	0 ~ 40957	Special Memory
B	T_Bit	DDDD	0 ~ 1023	Timer
B	C_Bit	DDDD	0 ~ 1023	Counter
B	DBnBit	FFFDDDDDo	0 ~ 255655357	
Byte	VB	DDDDD	0 ~ 10239	

Bit/Word	Device type	Format	Range	Memo
W	VW	DDDDD	0 ~ 10239	V Memory
W	VW_Odd	DDDDD	0 ~ 10239	V Memory
W	VW_String	DDDDD	0 ~ 10239	String
W	VW_String_Odd	DDDDD	0 ~ 10239	String
DW	VD	DDDDD	0 ~ 10239	V Memory Double
DW	VD_Odd	DDDDD	0 ~ 10239	V Memory Double
DW	VD_String	DDDDD	0 ~ 10239	String
DW	VD_String_Odd	DDDDD	0 ~ 10239	String
Byte	MB	DDDDD	0 ~ 10239	Byte Memory
W	MW	DDDDD	0 ~ 10239	Word Memory
W	MW_Odd	DDDDD	0 ~ 10239	Word Memory
DW	MD	DDDDD	0 ~ 10239	Word Memory
Byte	SB	DDDDD	0 ~ 10239	SCR
W	SW	DDDDD	0 ~ 10239	SCR
DW	SD	DDDDD	0 ~ 10239	SCR
Byte	SMB	DDDDD	0 ~ 10239	Special Memory
W	SMW	DDDDD	0 ~ 10239	Special Memory
DW	SMD	DDDDD	0 ~ 10239	Special Memory
W	T	DDD	0 ~ 1023	Timer
W	C	DDD	0 ~ 1023	Counter
Byte	DBBn	FFFDDDDD	0 ~ 25565535	
W	DBn	FFFDDDDD	0 ~ 25565535	
DW	DBDn	FFFDDDDD	0 ~ 25565535	
D	DBn_STRINGCHAR	FFFDDDDD	0 ~ 25565535	

- Double Word and floating point value must use VD device type.

Multi-HMIs-Multi-PLCs Communication Setting:



For S7-200 PLC, Multi-HMIs-Multi-PLCs communication can be achieved using S7/200 PPI driver, please refer to the settings below.

IN EasyBuilder COM Port Settings, two important parameters must be set:

COM Port Settings

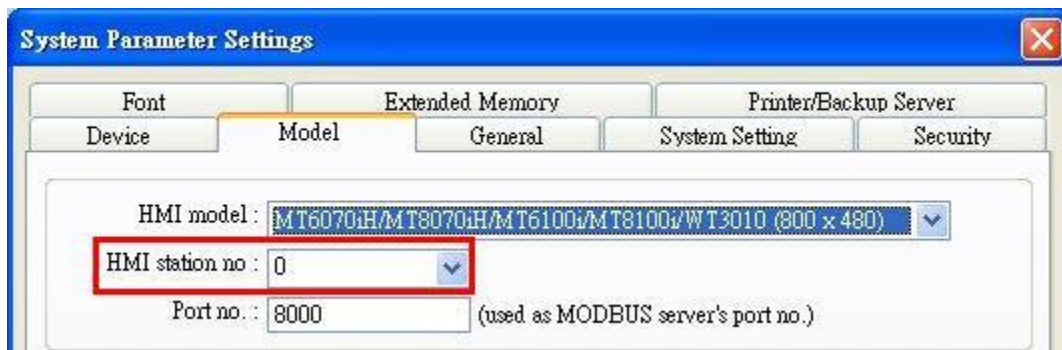
COM : <input type="text" value="COM 1"/>	Timeout (sec) : <input type="text" value="1.0"/>
Baud rate : <input type="text" value="9600"/>	Turn around delay (ms) : <input type="text" value="10"/>
Data bits : <input type="text" value="8 Bits"/>	Send ACK delay (ms) : <input type="text" value="30"/>
Parity : <input type="text" value="Even"/>	High station address (HSA) : <input type="text" value="3"/>
Stop bits : <input type="text" value="1 Bit"/>	Gap update factor (GUF) : <input type="text" value="1"/>
	The number of resending commands : <input type="text" value="0"/>

1. [High station address (HSA)]:

Setting Max. Station Number of HMI in PPI network.

For the effectiveness of system operation, it is highly recommended that the HMI station number starts from zero and go on sequentially. If there are 4 HMI in PPI network, set station no. from 0~3, and [High station address (HSA)] to 3.

Set HMI station number in [System Parameters] / [Model] / [HMI station no.]:



2. [Gap update factor(GUF)]:

The condition to pass a Token. In PPI network only HMI can hold a Token, PLC can only be controlled.

When the HMI that holds Token communicates with PLC for a number of times that equals to the value set here, HMI will pass the Token (control of PLC) to the next HMI. For example, if GUF is set to "1", HMI will pass the control of PLC to the next HMI when read or write the value in an address.

If GUF is set to a bigger value, the HMI that holds Token will control the PLC for a longer time and therefore the Token won't be passed to another HMI and cause failure in communicating with PLC.

A complete communication means HMI reads / writes PLC value for one time.

Note:

- HMI sta. no. can not be the same as PLC sta. no.
- Highly recommended that HMI sta. no. starts from 0 and go on sequentially for the effectiveness of operation.
- Available for EasyBuilder8000 V4.50 and later.

Wiring Diagram:

RS-485 2W 9P D-Sub (Diagram 1 ~ Diagram 6)

Diagram 1

cMT Series	<i>cMT3151</i>
eMT Series	<i>eMT3070 / eMT3105 / eMT3120 / eMT3150</i>

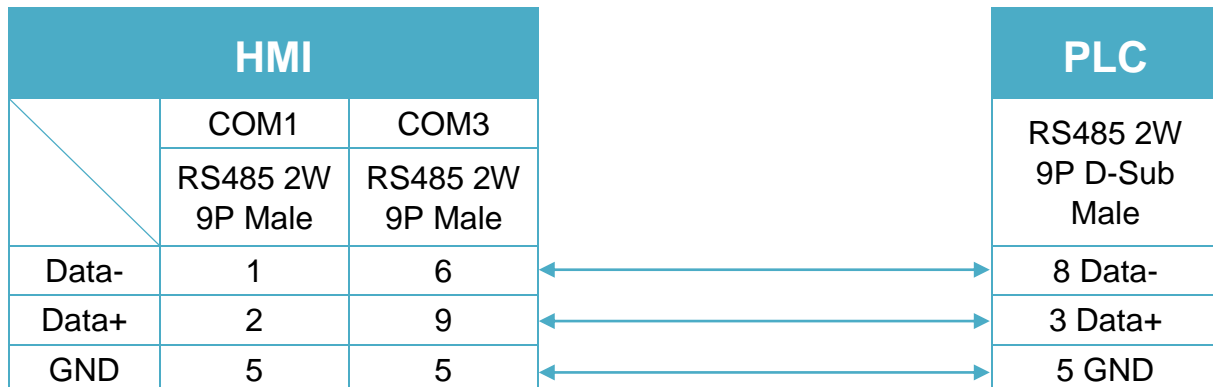


Diagram 2

cMT Series	<i>cMT-SVR</i>
mTV	<i>mTV</i>

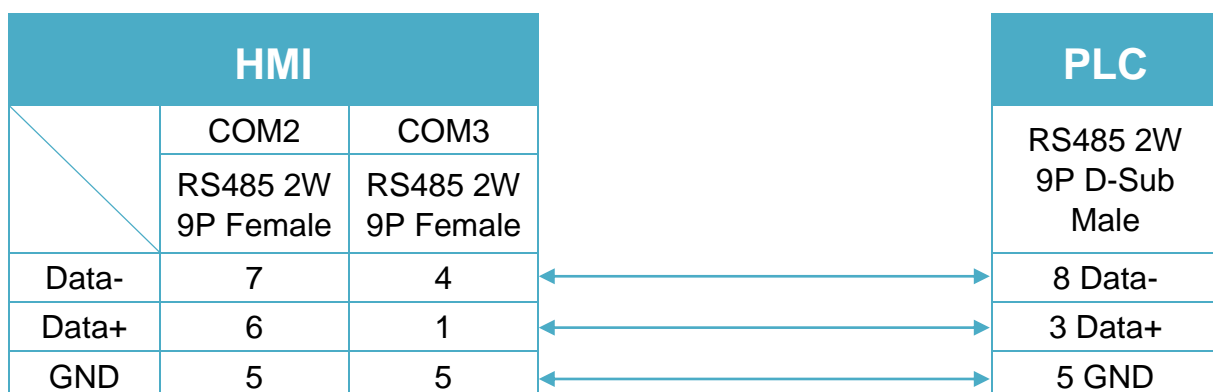


Diagram 3

MT-iE *MT8070iE / MT6070iE / MT8100iE / MT8121iE / MT8150iE*

MT-XE *MT8121XE / MT8150XE*

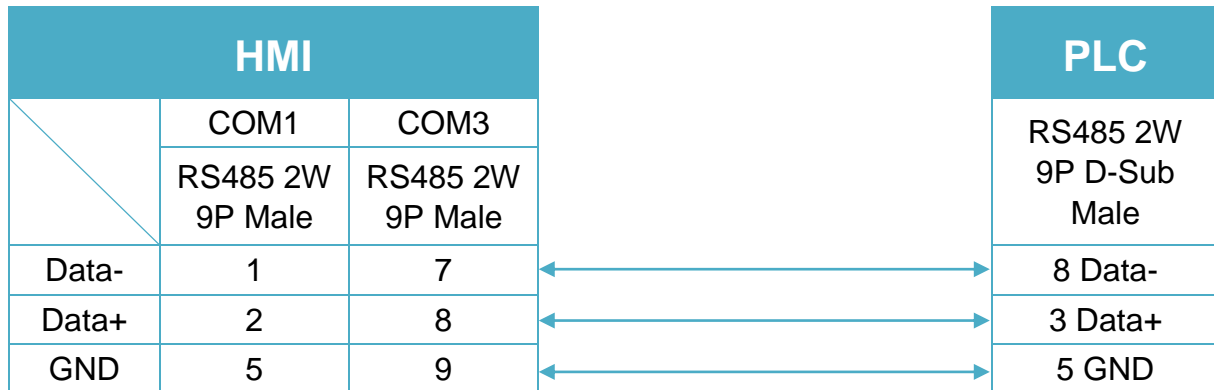


Diagram 4

MT-iE *MT8071iE / MT6071iE / MT8072iE / MT6072iE / MT8073iE /
MT8101iE / MT8102iE / MT8103iE*

MT-XE *MT8090XE / MT8092XE*

MT-iP *MT6103iP*

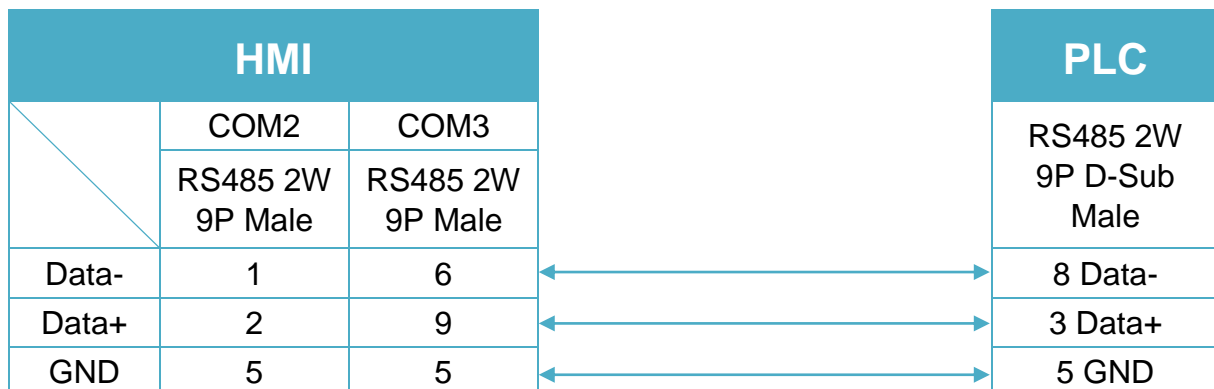


Diagram 5

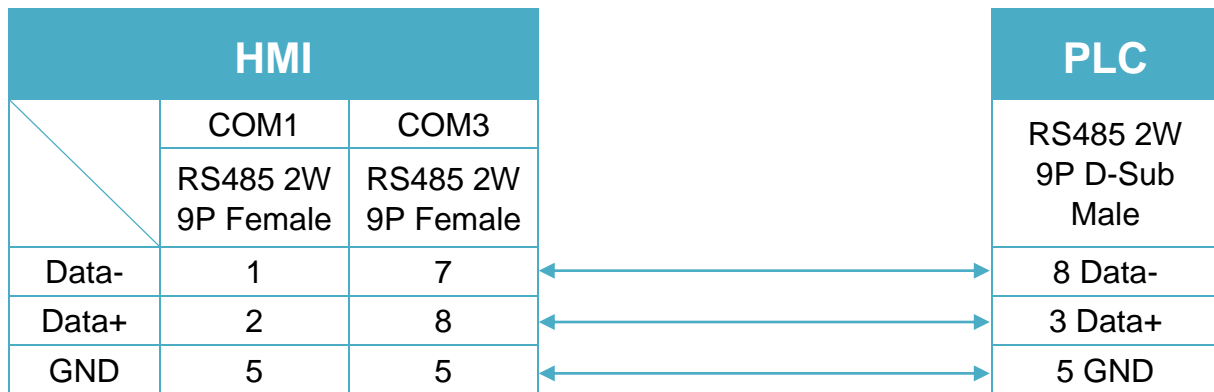
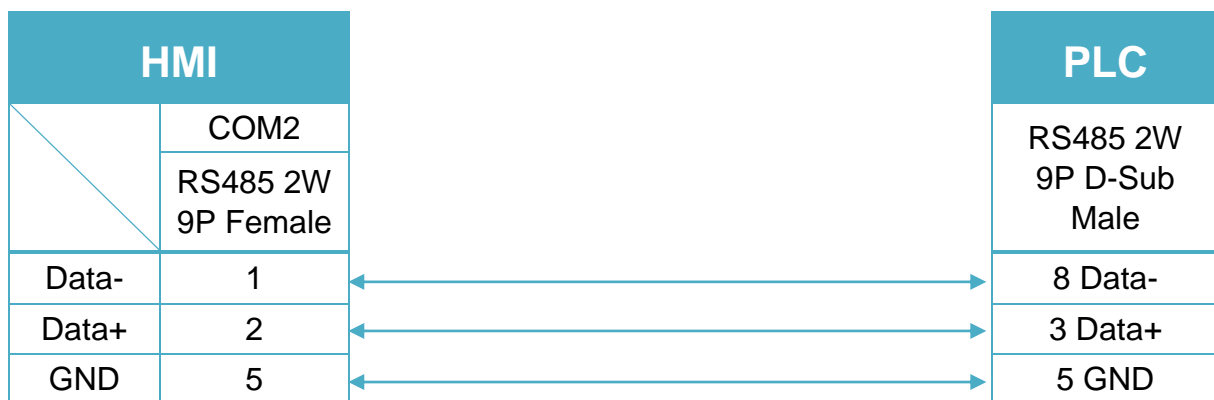
MT-iE *MT8050iE*
MT-iP *MT6051iP*


Diagram 6

MT-iP *MT6071iP / MT8071iP*


CROUZET M3 (FBD)

HMI Setting:

Parameters	Recommended	Options	Notes
PLC type	CROUZET M3 (FBD)		
PLC I/F	RS232		
Baud rate	115200		
Data bits	7		
Parity	Even		
Stop bits	1		
PLC sta. no.	1		

*Support communications between HMI and PLC in pass-through mode

*Set LW-9903 to 2 to enhance the speed of download/upload PLC program in pass-through mode

Device Address:

Bit/Word	Device type	Format	Range	Memo
B	I	DD	1 ~ 99	Input
B	SLI_Bit	DDh	10 ~ 24f	Serial link input
B	SLO_Bit	DDh	250 ~ 48f	Serial link output (read only)
B	State	D	1	State in PLC (read only)
W	AI	DD	1 ~ 99	Analogy input (default: 1 ~ 4)
W	SL_IN	DD	1 ~ 24	Serial link input
W	SL_OUT	DD	25 ~ 48	Serial link output (read only)
W	Time	D	1 ~ 6	Time & Day*
W	Order	D	1	Command** (write only)
W	ID_Table	DD	1 ~ 22	

* address 1: second, address 2 : minute, address 3 : hour , address 4 : day, address 5 : month, address 6 : year. The value range for “Year” is 0~99, entering “0” represents year 2000, entering “99” represents year 2099.

** run mode write 2, stop mode write 1.

Wiring Diagram:

CROUZET M3: RS-232 9P D-Sub (Diagram 1 ~ Diagram 4)

Diagram 1

cMT Series	<i>cMT3151</i>
eMT Series	<i>eMT3070 / eMT3105 / eMT3120 / eMT3150</i>
MT-iE	<i>MT8070iE / MT6070iE / MT8100iE / MT8121iE / MT8150iE / MT8071iE / MT6071iE / MT8072iE / MT6072iE / MT8073iE / MT8101iE / MT8102iE / MT8103iE</i>
MT-XE	<i>MT8121XE / MT8150XE / MT8090XE / MT8092XE</i>
MT-iP	<i>MT6103iP</i>

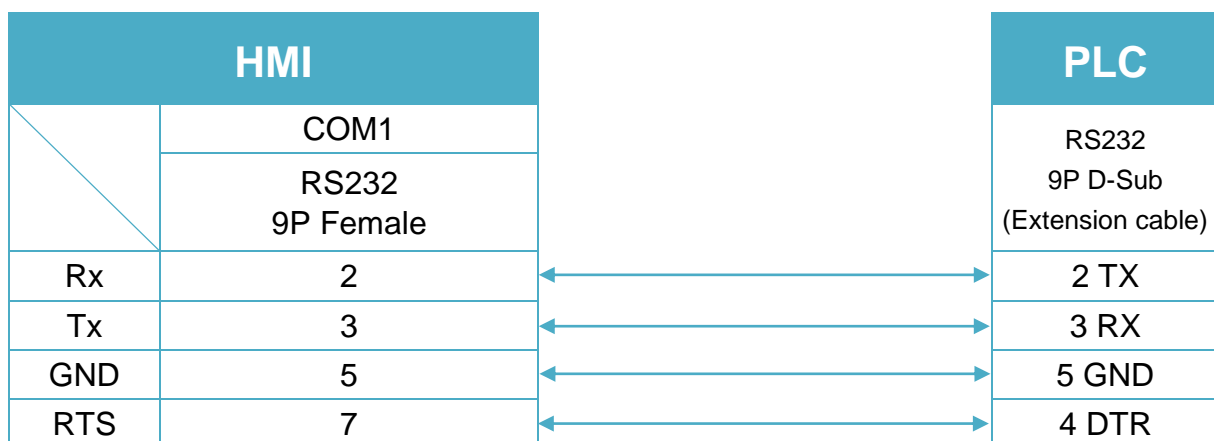


Diagram 2

cMT Series *cMT-SVR*

mTV *mTV*

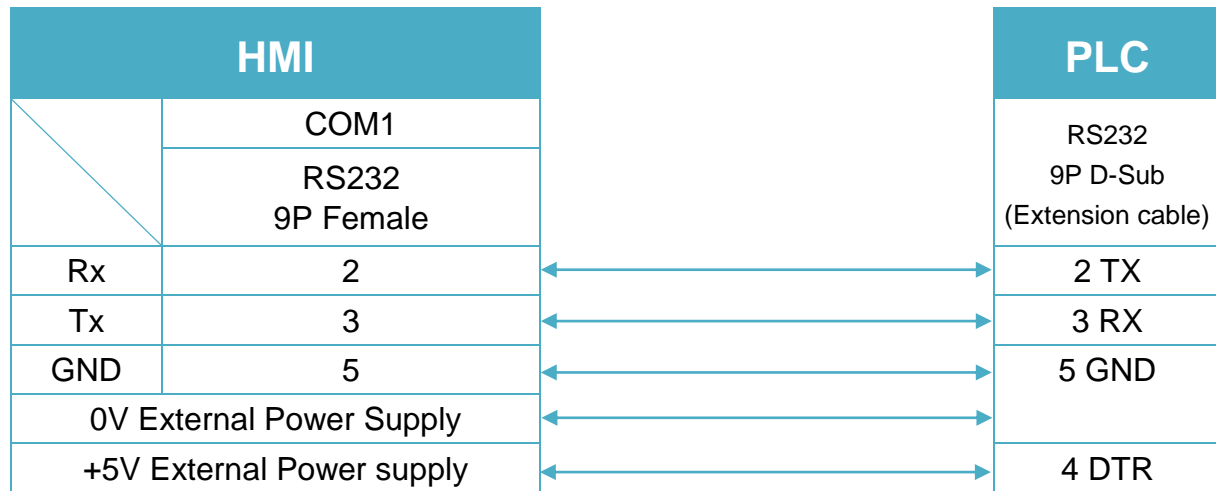


Diagram 3

MT-iE *MT8050iE*

MT-iP *MT6051iP*

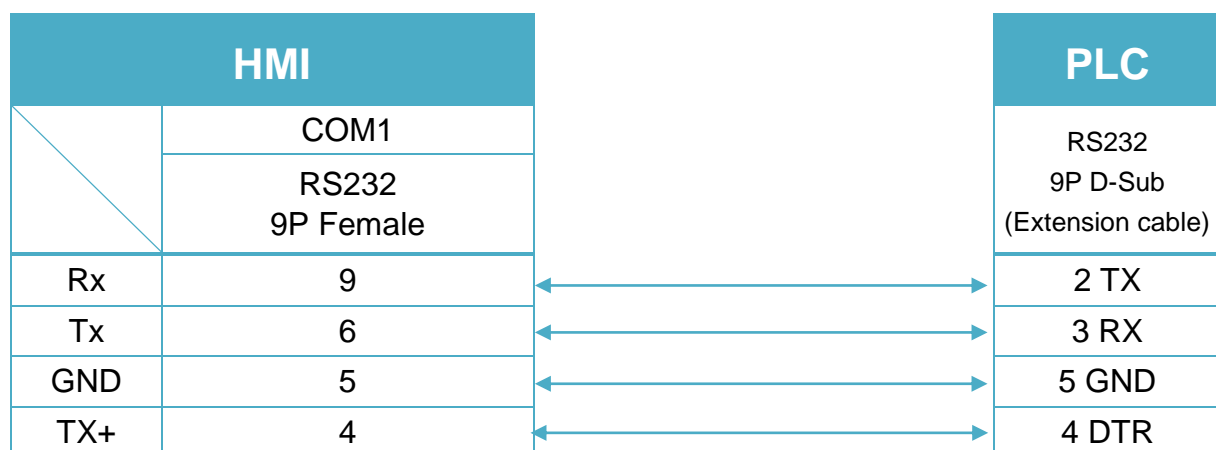
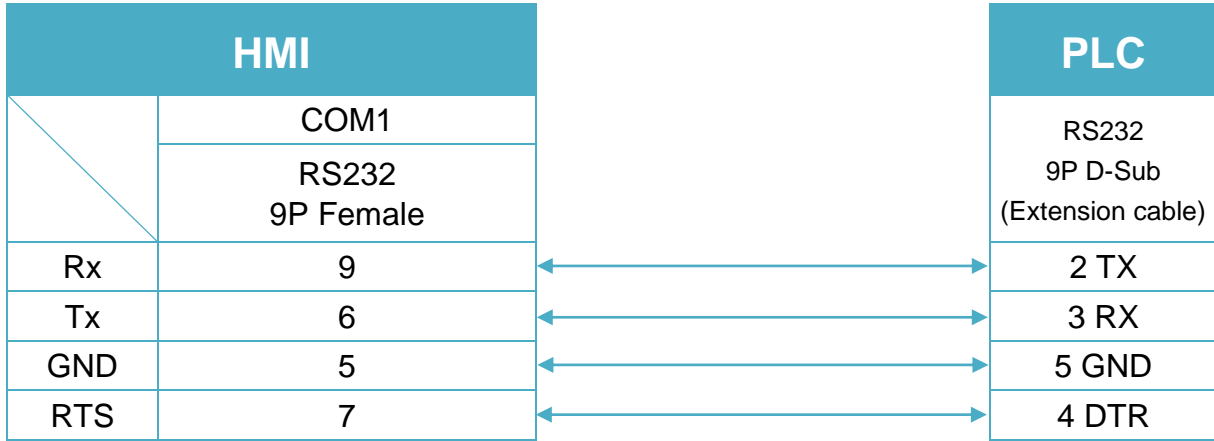
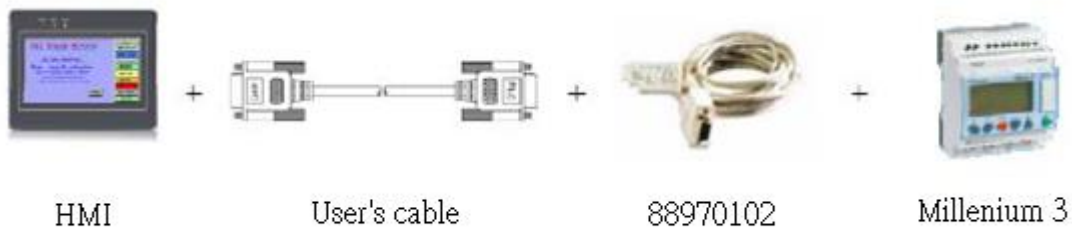


Diagram 4

MT-iP MT6071iP / MT8071iP



(3m serial link cable)
 Note: Please use 3m serial link cable (Accessories from Millenium 3) and extension cable (as shown) to communicate with HMI series.



CROUZET M3 (LAD)

HMI Setting:

Parameters	Recommended	Options	Notes
PLC type	CROUZET M3 (LAD)		
PLC I/F	RS232		
Baud rate	115200		
Data bits	7		
Parity	Even		
Stop bits	1		
PLC sta. no.	1		

*Support communications between HMI and PLC in pass-through mode

*Set LW-9903 to 2 to enhance the speed of download/upload PLC program in pass-through mode

Device Address:

Bit/Word	Device type	Format	Range	Memo
B	I	DD	1 ~ 99	Input (default: 1 ~ 4)
B	O	DD	1 ~ 99	Output (default: 1 ~ 4)
B	M	DD	1 ~ 28	Relay
B	SLI_Bit	DDh	10 ~ 24f	Serial link input
B	SLO_Bit	DDh	250 ~ 48f	Serial link output (read only)
B	State	D	1	State in PLC (read only)
W	T	DD	1 ~ 12	Timer
W	C	DD	1 ~ 16	Counter
W	AI	DD	1 ~ 99	Analogy input (default: 1 ~ 4)
W	SL_IN	DD	1 ~ 24	Serial link input
W	SL_OUT	DD	25 ~ 48	Serial link output (read only)
W	Time	D	1 ~ 6	Time & Day *
W	Order	D	1	Command (write only) **

* address 1: second, address 2 : minute, address 3 : hour , address 4 : day, address 5 : month, address 6 : year .The value range for “Year” is 0~99, entering “0” represents year 2000, entering “99” represents year 2099.

** run mode write 2, stop mode write 1.

Wiring Diagram:

CROUZET M3: RS-232 9P D-Sub (Diagram 1 ~ Diagram 4)

Diagram 1

cMT Series	<i>cMT3151</i>
eMT Series	<i>eMT3070 / eMT3105 / eMT3120 / eMT3150</i>
MT-iE	<i>MT8070iE / MT6070iE / MT8100iE / MT8121iE / MT8150iE / MT8071iE / MT6071iE / MT8072iE / MT6072iE / MT8073iE / MT8101iE / MT8102iE / MT8103iE</i>
MT-XE	<i>MT8121XE / MT8150XE / MT8090XE / MT8092XE</i>
MT-iP	<i>MT6103iP</i>

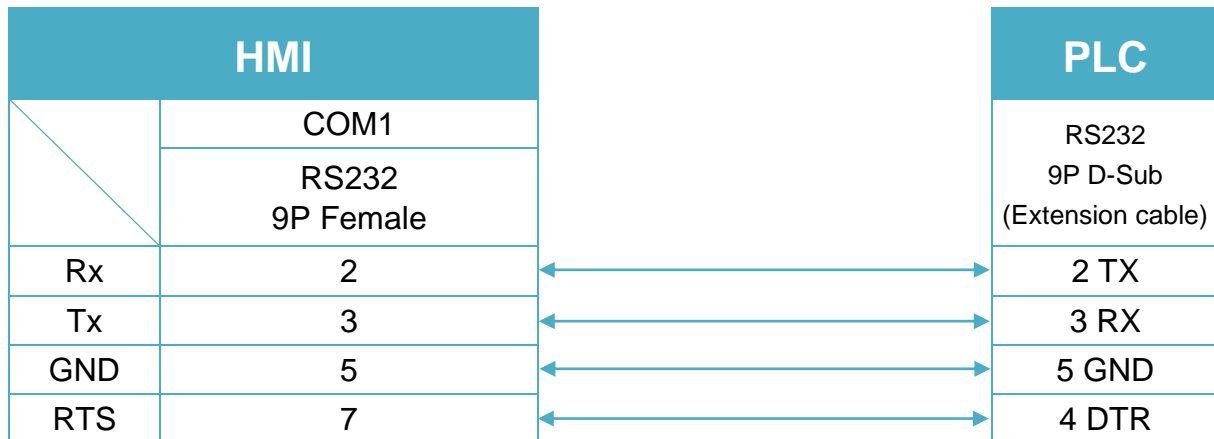


Diagram 2

cMT Series *cMT-SVR*

mTV *mTV*

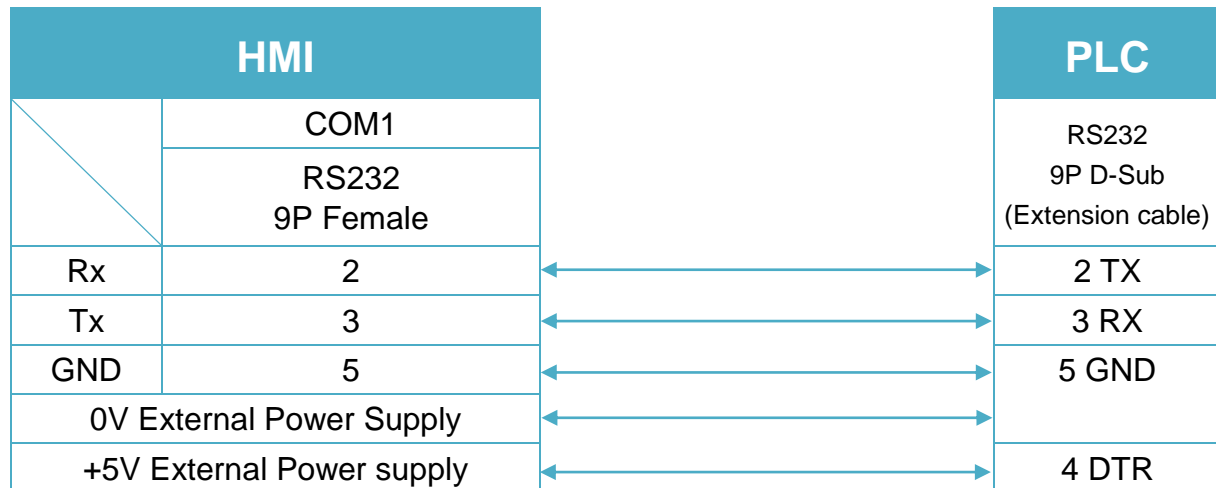


Diagram 3

MT-iE *MT8050iE*

MT-iP *MT6051iP*

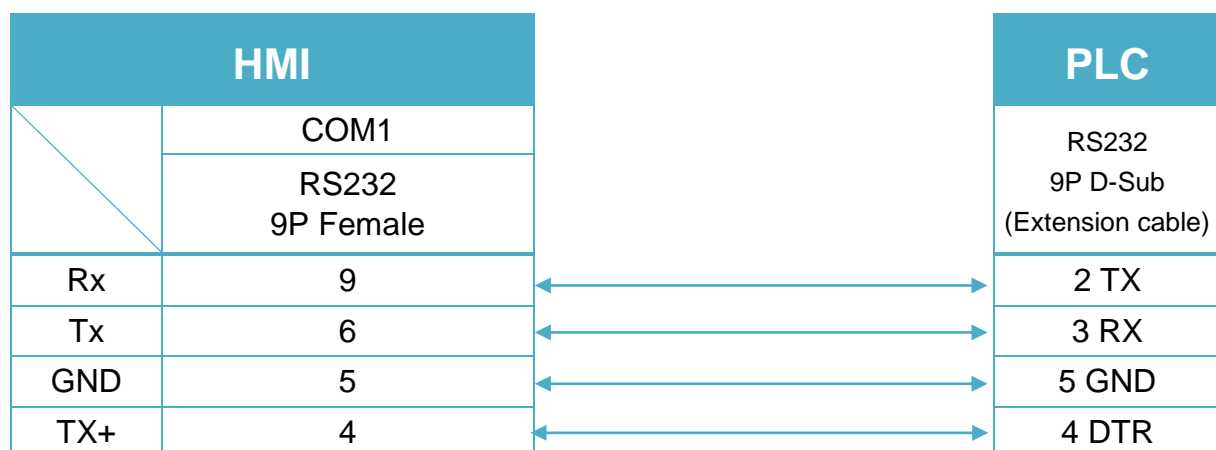
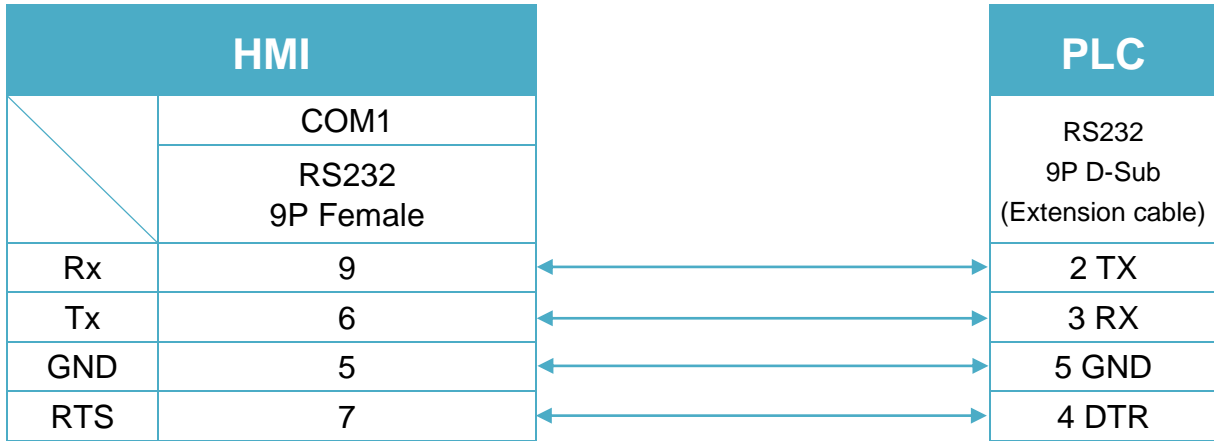


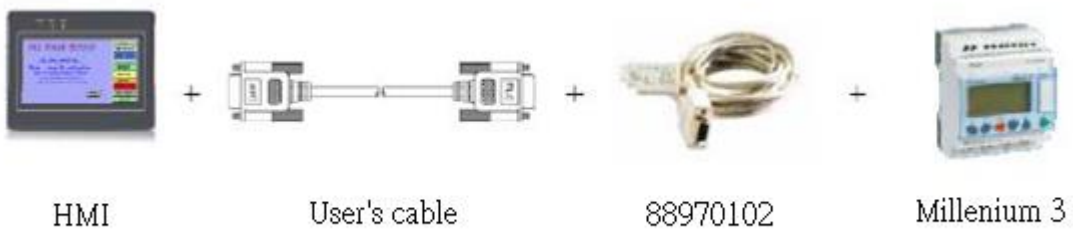
Diagram 4

MT-iP *MT6071iP / MT8071iP*



(3m serial link cable)

Note: Please use 3m serial link cable (Accessories from Millenium 3) and extension cable (as shown) to communicate with HMI series.



Danfoss ECL Apex20

Website: <http://www.danfoss.com/>

HMI Setting:

Parameters	Recommended	Options	Notes
PLC type	Danfoss ECL Apex20		
PLC I/F	RS232		
Baud rate	9600		
Data bits	8		
Parity	None		
Stop bits	1		
PLC sta. no.	1		

Device Address:

Bit/Word	Device type	Format	Range	Memo
B	Flag	DDDD	0 ~ 8191	
B	Output	DDDD	0 ~ 1023	
B	Input	DDDD	0 ~ 1023	
B	Reg_Bit	DDDDdd	0 ~ 1638331	dd: Bit no. (00 ~ 31)
DW	Register	DDDDD	0 ~ 16383	
DW	Counter	DDDD	0 ~ 1599	
DW	Timer	DDDD	0 ~ 1599	
DW	Reg_Float	DDDDD	0 ~ 16383	Support 32-bit float format
W	DBn	DDDDDDD	0 ~ 8191383	

EasyBuilder device address range may differ from PLC extended mode, please refer to EasyBuilder address range as above.

Wiring Diagram:

ECL Apex20 Controller: RS-232 9P D-Sub (Diagram 1 ~ Diagram 3)

Diagram 1

cMT Series	<i>cMT3151</i>
eMT Series	<i>eMT3070 / eMT3105 / eMT3120 / eMT3150</i>
MT-iE	<i>MT8073iE / MT8102iE</i>
MT-XE	<i>MT8092XE</i>
MT-iP	<i>MT6103iP</i>

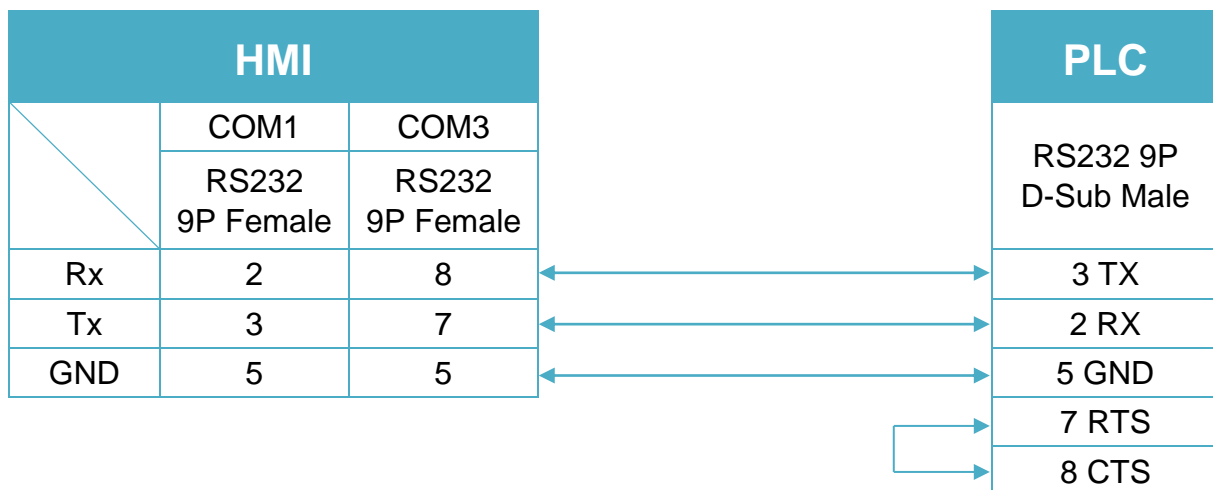


Diagram 2

cMT Series	cMT-SVR
mTV	mTV
MT-iE	MT8070iE / MT6070iE / MT8100iE / MT8121iE / MT8150iE / MT8071iE / MT6071iE / MT8072iE / MT6072iE / MT8073iE / MT8101iE / MT8102iE / MT8103iE
MT-XE	MT8121XE / MT8150XE / MT8090XE

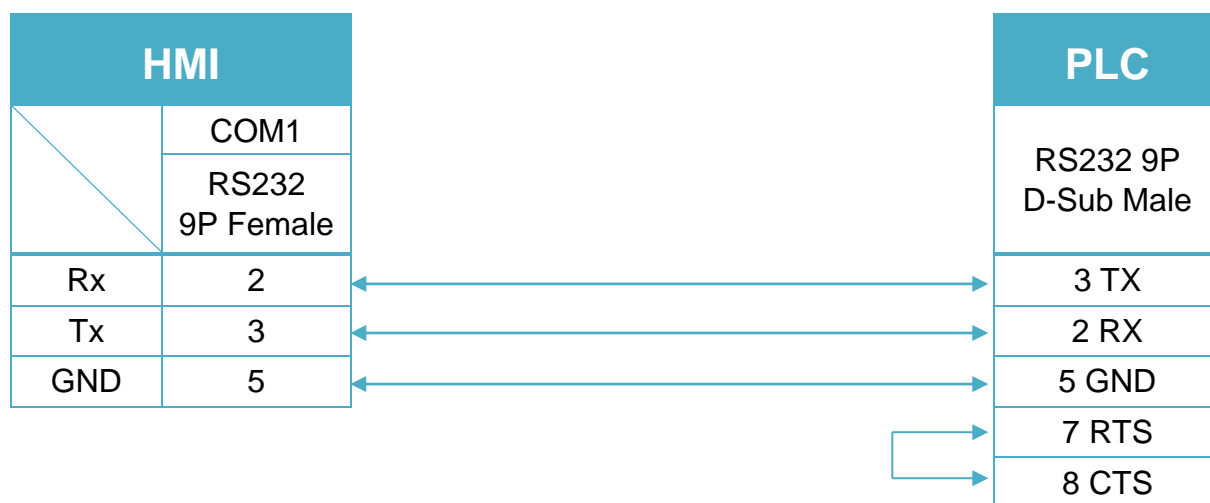
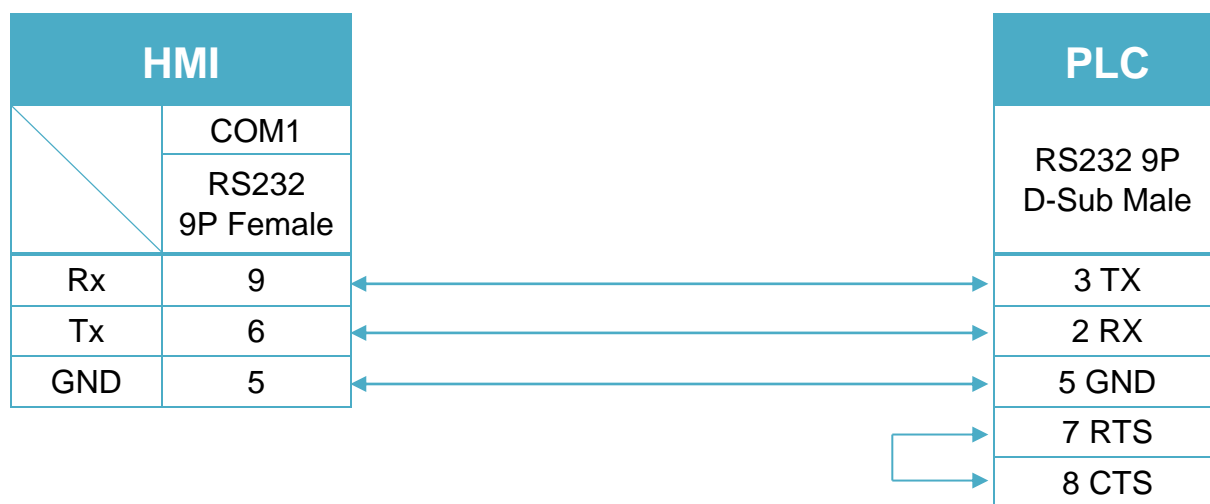


Diagram 3

MT-iE	MT8050iE
MT-iP	MT6051iP / MT6071iP / MT8071iP



ECL Apex20 Controller: RS-485 2W Terminal (Diagram 4 ~ Diagram 9)

Diagram 4

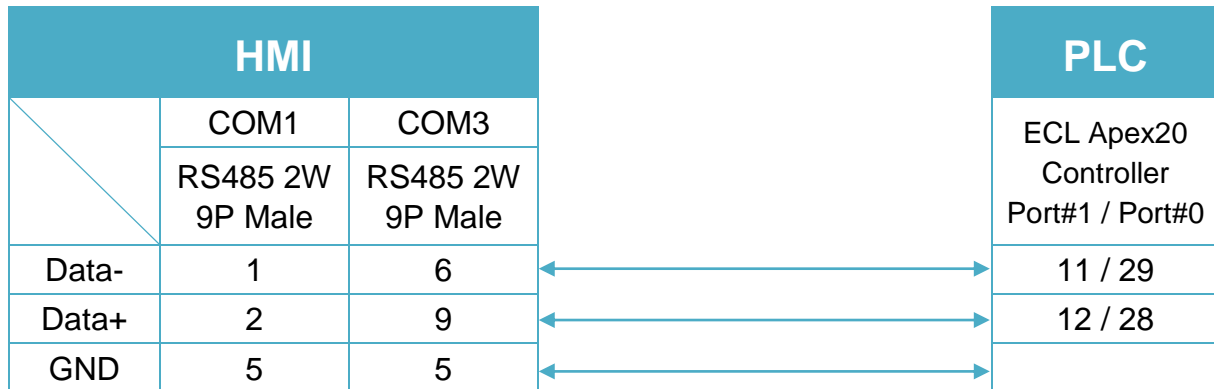
cMT Series *cMT3151*
eMT Series *eMT3070 / eMT3105 / eMT3120 / eMT3150*


Diagram 5

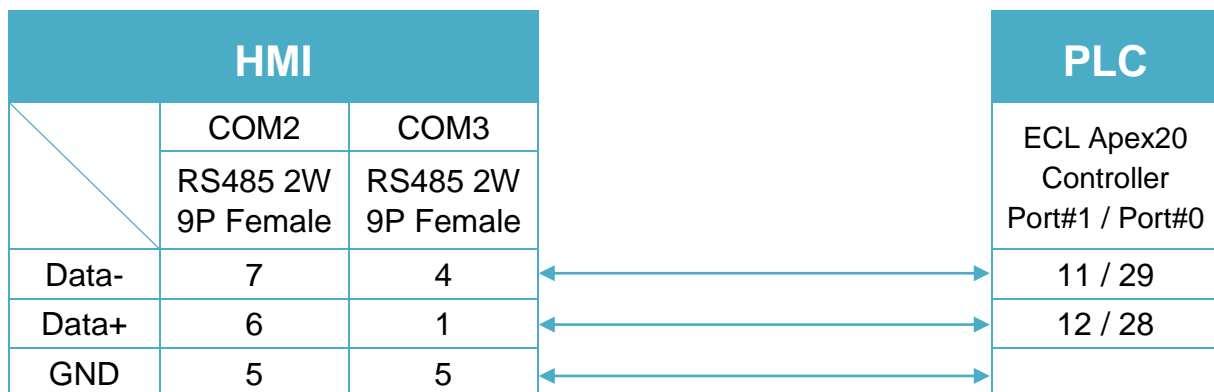
cMT Series *cMT-SVR*
mTV *mTV*


Diagram 6

MT-iE *MT8070iE / MT6070iE / MT8100iE / MT8121iE / MT8150iE*

MT-XE *MT8121XE / MT8150XE*

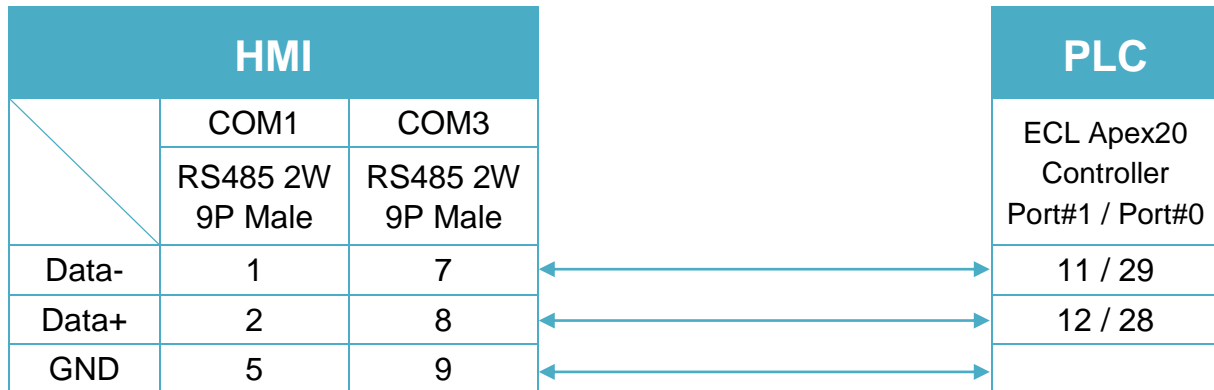


Diagram 7

MT-iE *MT8071iE / MT6071iE / MT8072iE / MT6072iE / MT8073iE /
MT8101iE / MT8102iE / MT8103iE*

MT-XE *MT8090XE / MT8092XE*

MT-iP *MT6103iP*

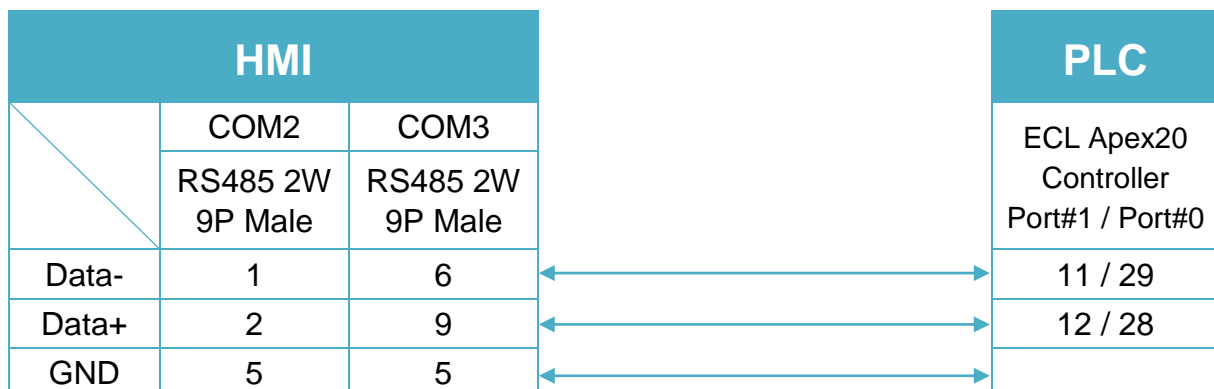
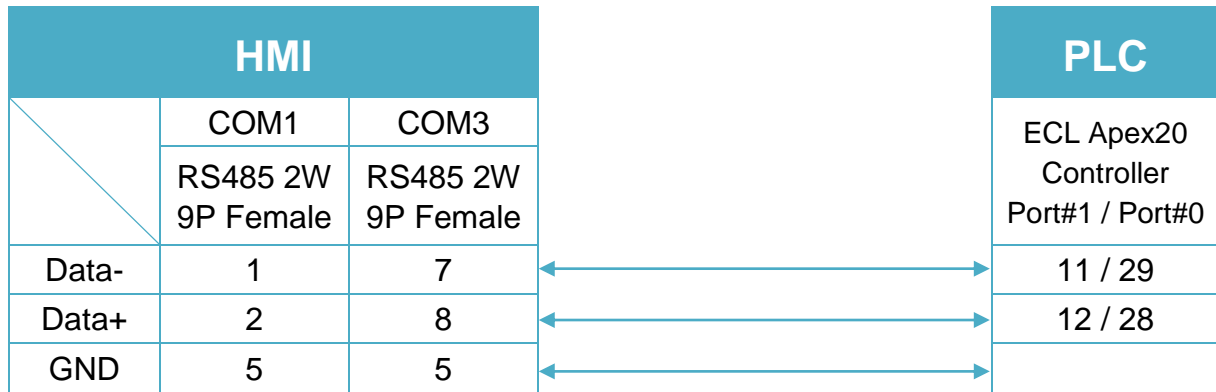


Diagram 8
MT-iE *MT8050iE*
MT-iP *MT6051iP*

Diagram 9
MT-iP *MT6071iP / MT8071iP*


Danfoss ECL Apex20 (Ethernet)

Website: <http://www.danfoss.com/>

HMI Setting:

Parameters	Recommended	Options	Notes
PLC type	Danfoss ECL Apex20 (Ethernet)		
PLC I/F	Ethernet		
Port no.	5050		
PLC sta. no.	0		

Device Address:

Bit/Word	Device type	Format	Range	Memo
B	Flag	DDDD	0 ~ 8191	
B	Output	DDDD	0 ~ 1023	
B	Input	DDDD	0 ~ 1023	
B	Reg_Bit	DDDDdd	0 ~ 1638331	dd: Bit no. (00 ~ 31)
B	DBn_Bit	DDDDDDdd	0 ~ 399938331	
W	Register	DDDD	0 ~ 16383	
W	Counter	DDDD	0 ~ 1599	
W	Timer	DDDD	0 ~ 1599	
W	Reg_Float	DDDD	0 ~ 16383	Support 32-bit float format
W	DBn	DDDDDDDD	0 ~ 536016383	
W	DB_String	DDDDDDDD	0 ~ 536016383	
W	R_String	DDDD	0 ~ 16383	
W	DB_Float	DDDDDDDD	0 ~ 536016383	

EasyBuilder device address range may differ from PLC extended mode, please refer to EasyBuilder address range as above.

Wiring Diagram:

Ethernet cable:



Danfoss FC Series

Supported Series: FC051, FC100, FC200, FC300, VLT Micro Driver.

Website: <http://www.danfoss.com/>

HMI Setting:

Parameters	Recommended	Options	Notes
PLC type	Danfoss FC Series		
PLC I/F	RS485 2W		
Baud rate	9600		
Data bits	8		
Parity	Even		
Stop bits	1		
PLC sta. no.	1		

Device Address:

Bit/Wor	Device type	Format	Range	Memo	
W	Parameter	09	DDDD	0 ~ 9999	Set Parameter
DW	Reference	10	D	0 ~ 1	Control Bus Reference
DW	Para_Index	11	DDDDDD	0 ~ 999999	Set Parameter(Index)

Para_Index 310.1=31001, Para_Index310.0=31000

Wiring Diagram:

RS-485 2W Terminal (Diagram 1 ~ Diagram 6)

Diagram 1

cMT Series	<i>cMT3151</i>
eMT Series	<i>eMT3070 / eMT3105 / eMT3120 / eMT3150</i>

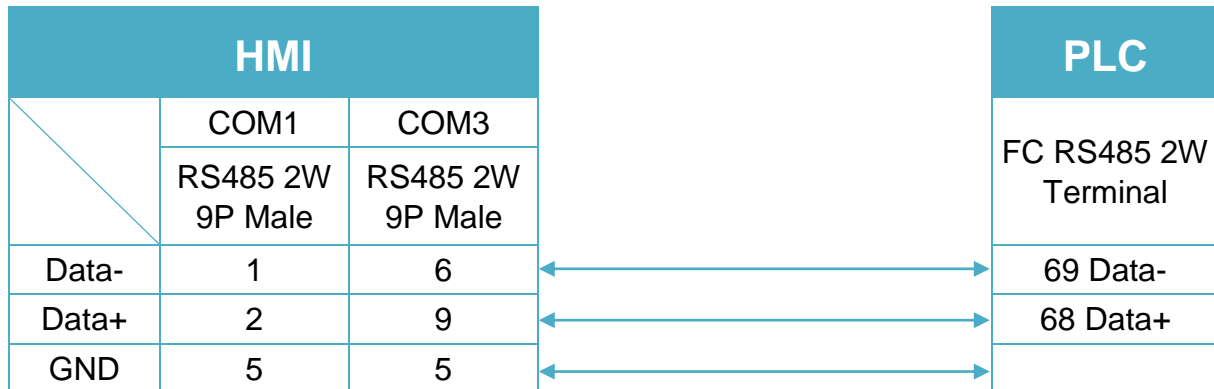
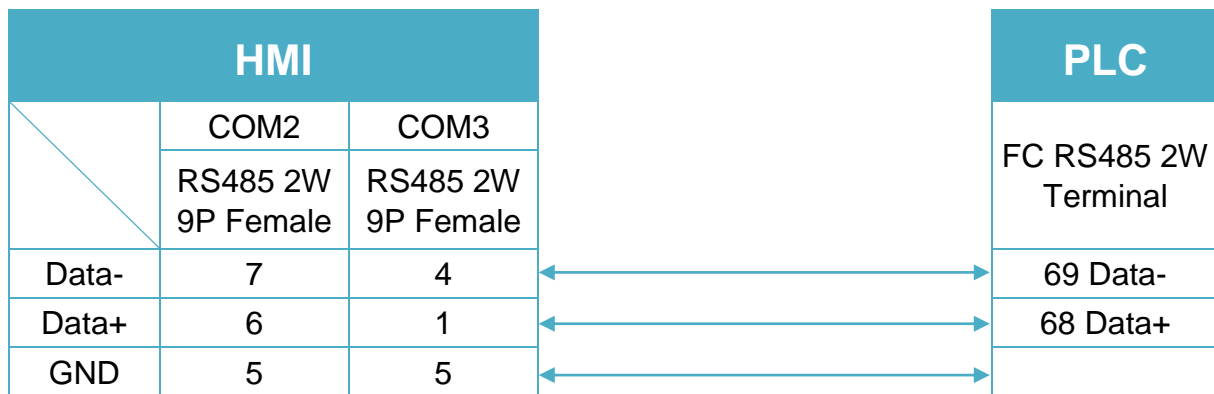
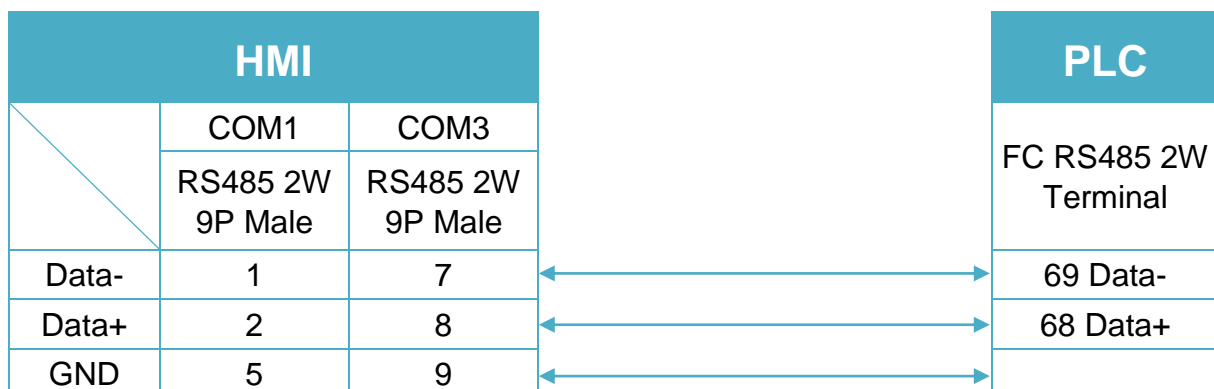

Diagram 2
cMT Series *cMT-SVR*
mTV *mTV*

Diagram 3
MT-iE *MT8070iE / MT6070iE / MT8100iE / MT8121iE / MT8150iE*
MT-XE *MT8121XE / MT8150XE*


Diagram 4

MT-iE	<i>MT8071iE / MT6071iE / MT8072iE / MT6072iE / MT8073iE / MT8101iE / MT8102iE / MT8103iE</i>
MT-XE	<i>MT8090XE / MT8092XE</i>
MT-iP	<i>MT6103iP</i>

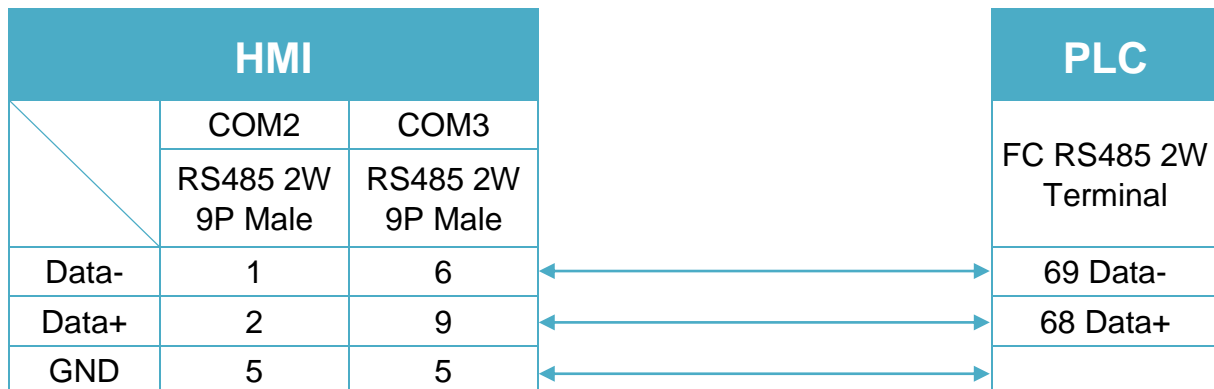


Diagram 5

MT-iE	<i>MT8050iE</i>
MT-iP	<i>MT6051iP</i>

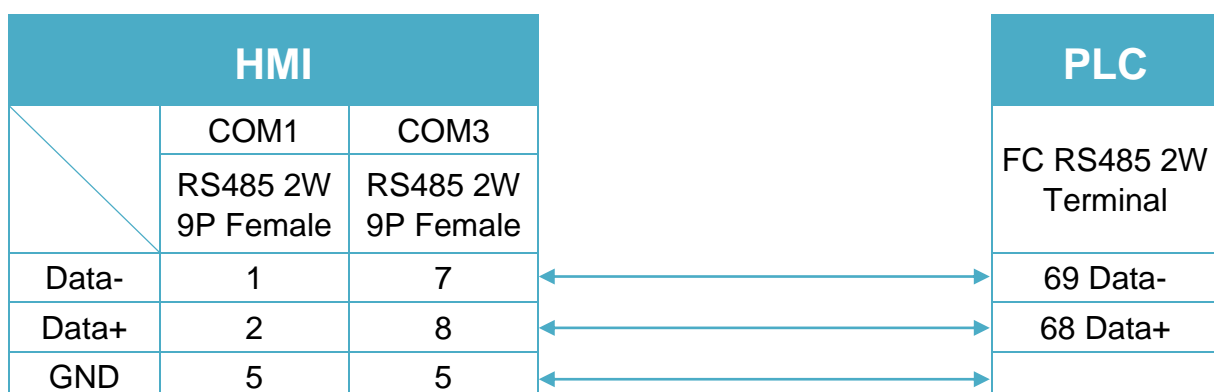
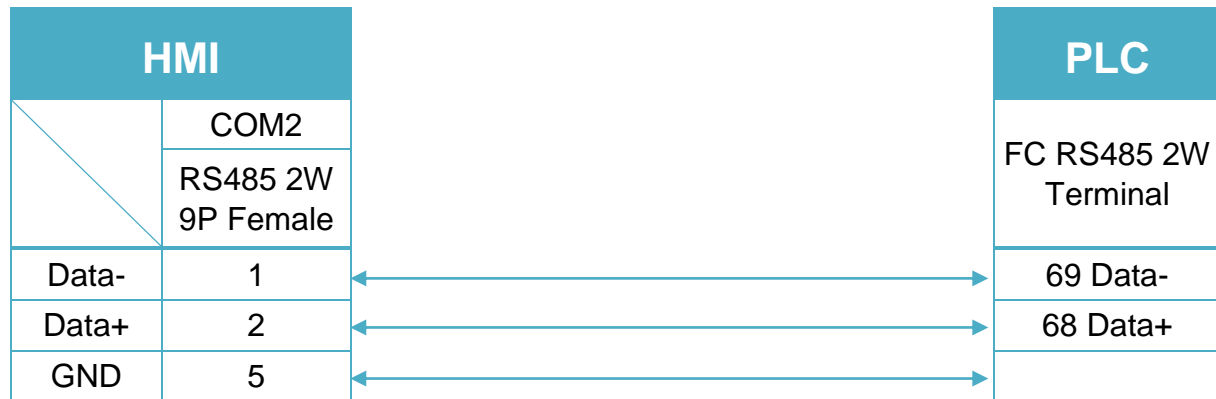


Diagram 6

MT-iP
MT6071iP / MT8071iP


*RW100 set PCD1 Control Word of station 1

*RW101 read PCD1 Status Word of station 1

*RW102 set PCD2 Control Word of station 2

*RW103 read PCD2 Status Word of station 2

*RW104 set PCD3 Control Word of station 3

*RW105 read PCD3 Status Word of station 3

*RW106 set PCD4 Control Word of station 4

*RW107 read PCD4 Status Word of station 4

Danfoss VLT2800 Series

Supported Series: VLT2800 series

Website: <http://www.danfoss.com/>

HMI Setting:

Parameters	Recommended	Options	Notes
PLC type	Danfoss VLT2800 Series		
PLC I/F	RS485 2W		
Baud rate	9600		
Data bits	8		
Parity	Even		
Stop bits	1		
PLC sta. no.	1	0-126	According to PLC

PLC Setting:

Communication mode	9600, Even, 8, 1 (default)
---------------------------	----------------------------

Device Address:

Bit/Word	Device type	Format	Range	Memo
DW	Parameter	DDDD	0 ~ 2000	Set Parameter
W	Reference	D	0 ~ 1	Control Bus Reference

The control word register is set according to the station number.

If the station number is 1, the control word will be RW100 and RW101; if the station number is 2, the control word will be RW102 and RW103, and so on.

Wiring Diagram:

RS-485 2W Terminal (Diagram 1 ~ Diagram 6)

Diagram 1

cMT Series	<i>cMT3151</i>
eMT Series	<i>eMT3070 / eMT3105 / eMT3120 / eMT3150</i>

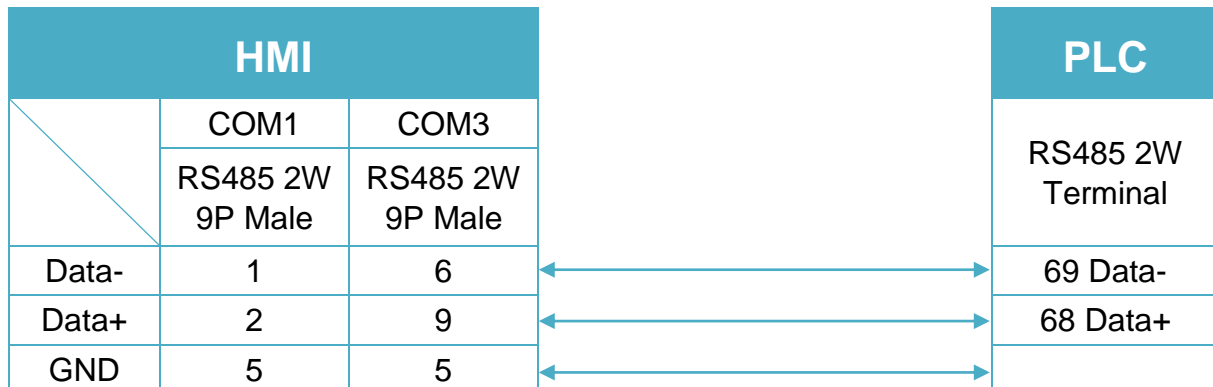


Diagram 2

cMT Series	<i>cMT-SVR</i>
mTV	<i>mTV</i>

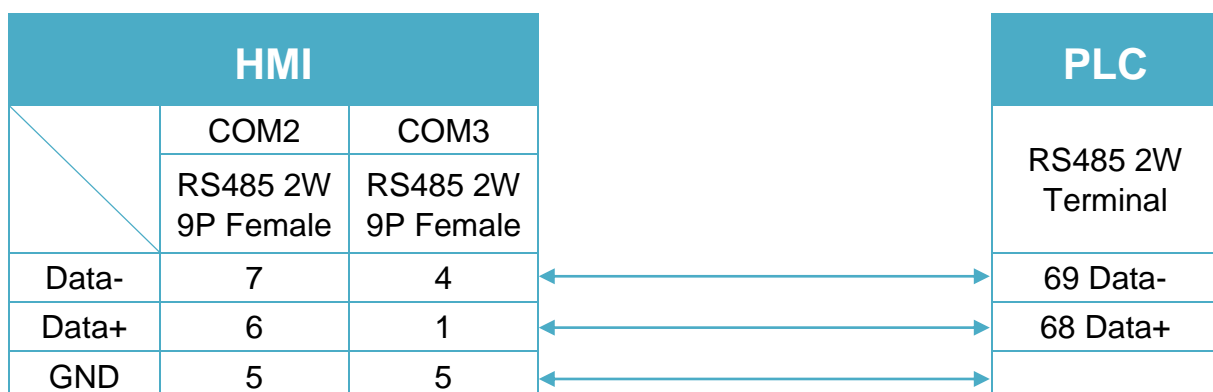


Diagram 3

MT-iE *MT8070iE / MT6070iE / MT8100iE / MT8121iE / MT8150iE*

MT-XE *MT8121XE / MT8150XE*

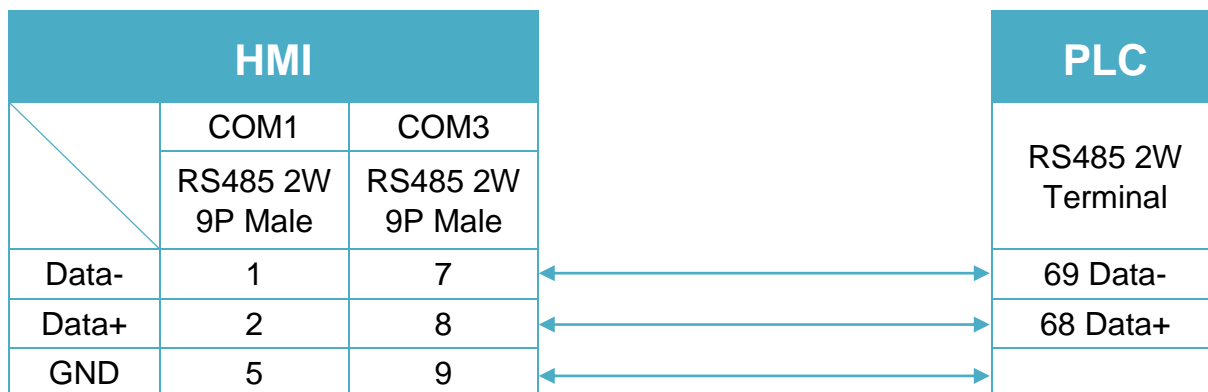


Diagram 4

MT-iE *MT8071iE / MT6071iE / MT8072iE / MT6072iE / MT8073iE /
MT8101iE / MT8102iE / MT8103iE*

MT-XE *MT8090XE / MT8092XE*

MT-iP *MT6103iP*

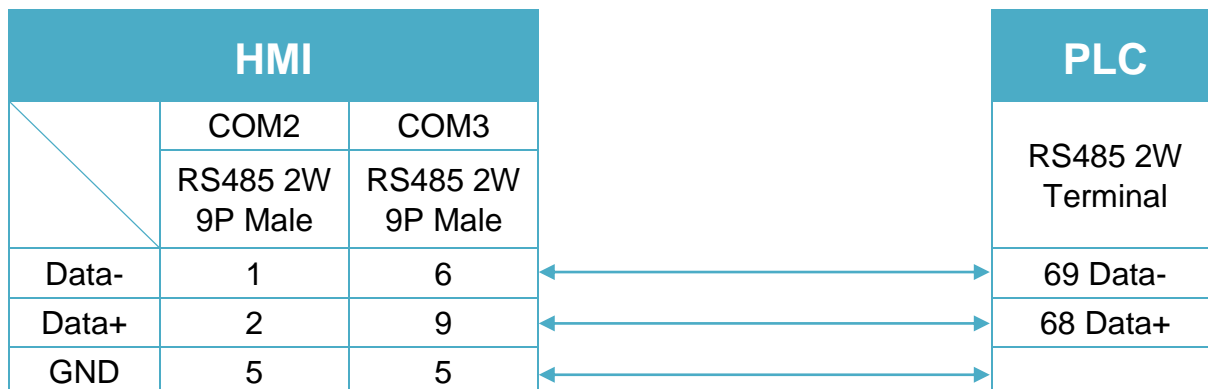


Diagram 5

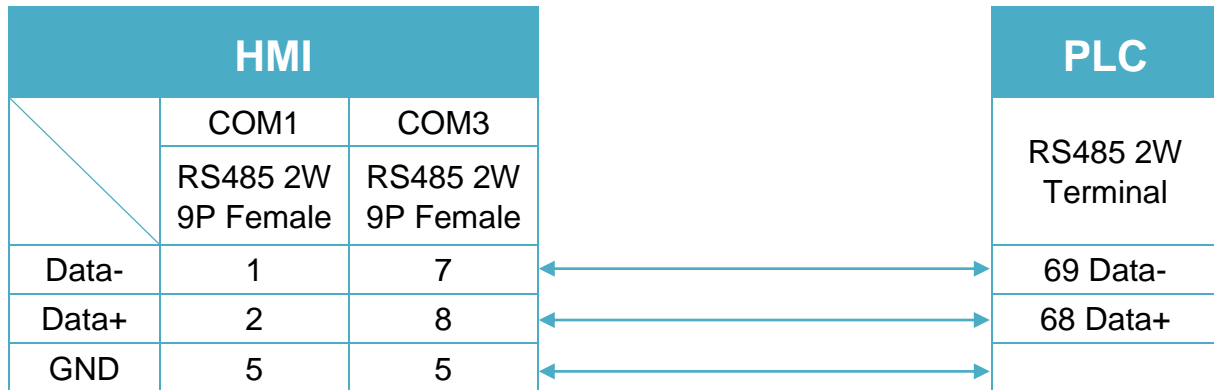
MT-iE *MT8050iE*
MT-iP *MT6051iP*


Diagram 6

MT-iP *MT6071iP / MT8071iP*


DELTA AS300 MODBUS RTU/ASCII

Supported Series: DELTA AS300

Website: <http://www.deltadriver.com>

HMI Setting:

Parameters	Recommended	Options	Notes
PLC type	DELTA DVP		
PLC I/F	RS485 2W		
Baud rate	9600	9600 ~ 115200	
Data bits	7	7,8	
Parity	Even	Even / Odd / None	
Stop bits	1	1,2	
PLC sta. no.	1	1 ~ 254	
Modbus protocol	ASCII	RTU / ASCII	

Device Address:

Bit/Word	Device type	Format	Range	Memo
B	X_Bit	DDdd	0 ~ 6315	
B	Y_Bit	DDdd	0 ~ 6315	
B	M	DDDD	0 ~ 8191	
B	SM	DDDD	0 ~ 4095	
B	S	DDDD	0 ~ 2047	
B	T_Flag	DDD	0 ~ 511	
B	C_Flag	DDD	0 ~ 511	
B	HC_Flag	DDD	0 ~ 255	
B	D_Bit	DDDDDDdd	0 ~ 2999915	
W	X	DD	0 ~ 63	
W	Y	DD	0 ~ 63	
W	SR	DDDD	0 ~ 2047	
W	D	DDDDD	0 ~ 29999	
W	T	DDD	0 ~ 511	
W	C	DDD	0 ~ 511	
DW	HC	DDD	0 ~ 255	
W	E	D	0 ~ 9	

Wiring Diagram:

RS-485 2W Terminal (Diagram 1 ~ Diagram 6)

Diagram 1

cMT Series **cMT3151**

eMT Series **eMT3070 / eMT3105 / eMT3120 / eMT3150**

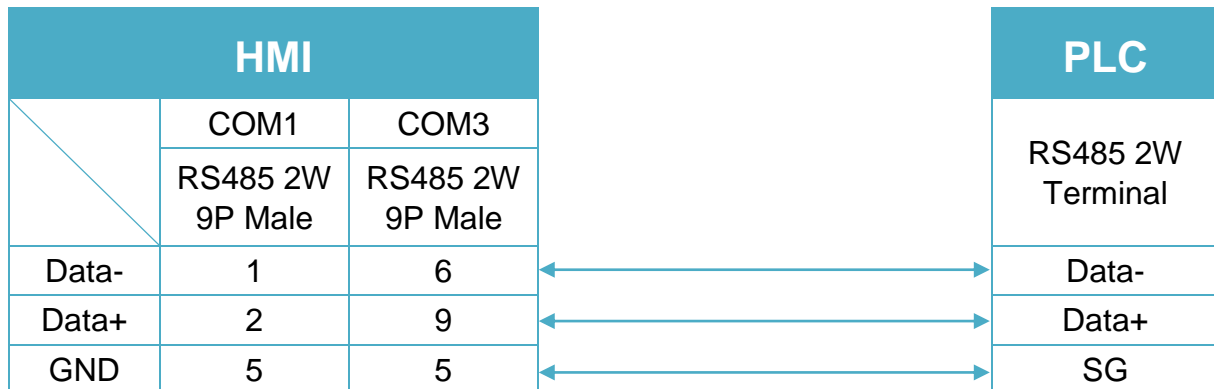


Diagram 2

cMT Series **cMT-SVR**

mTV **mTV**

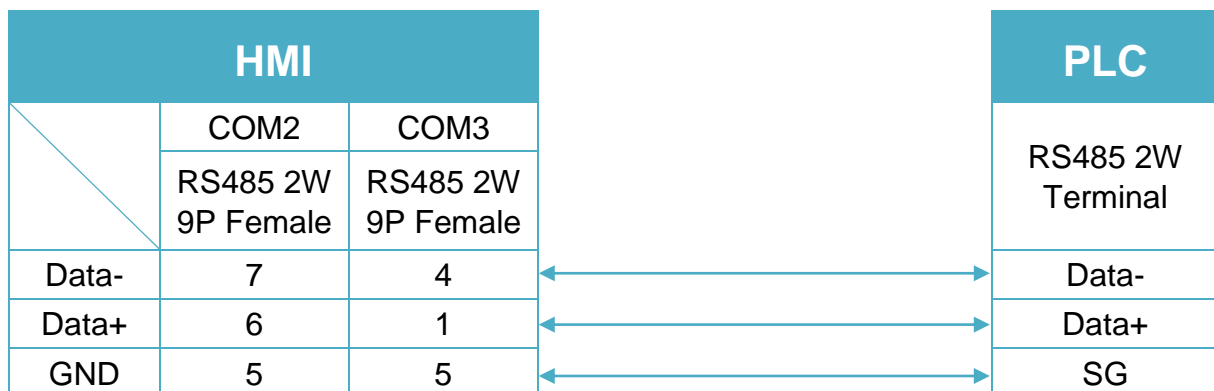


Diagram 3

MT-iE *MT8070iE / MT6070iE / MT8100iE / MT8121iE / MT8150iE*

MT-XE *MT8121XE / MT8150XE*

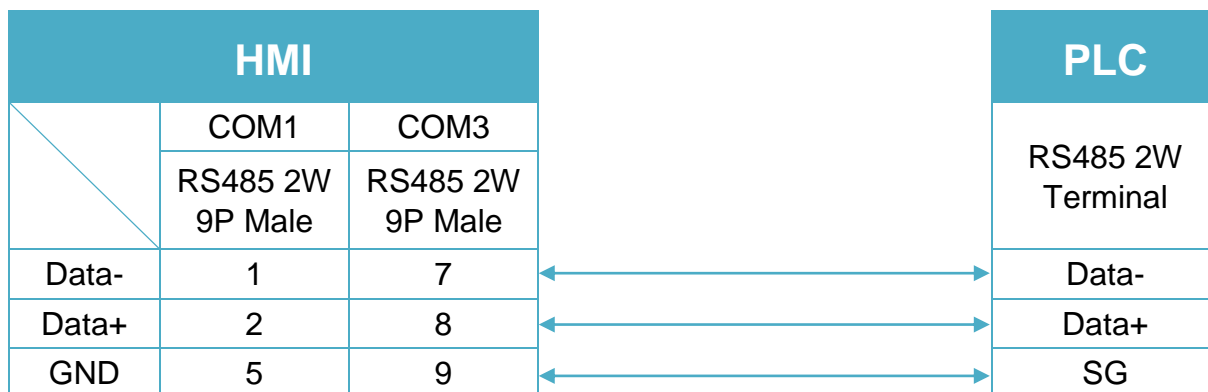


Diagram 4

MT-iE *MT8071iE / MT6071iE / MT8072iE / MT6072iE / MT8073iE /
MT8101iE / MT8102iE / MT8103iE*

MT-XE *MT8090XE / MT8092XE*

MT-iP *MT6103iP*

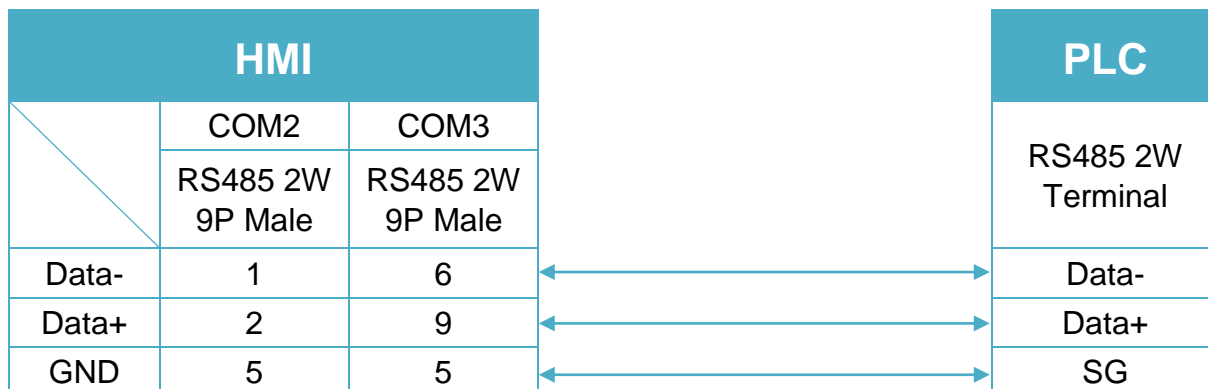


Diagram 5

MT-iE ***MT8050iE***

MT-iP ***MT6051iP***

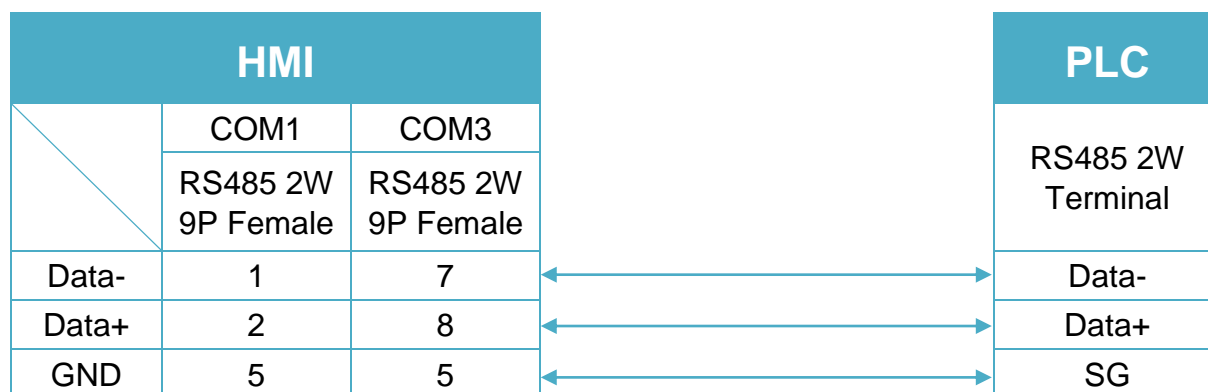
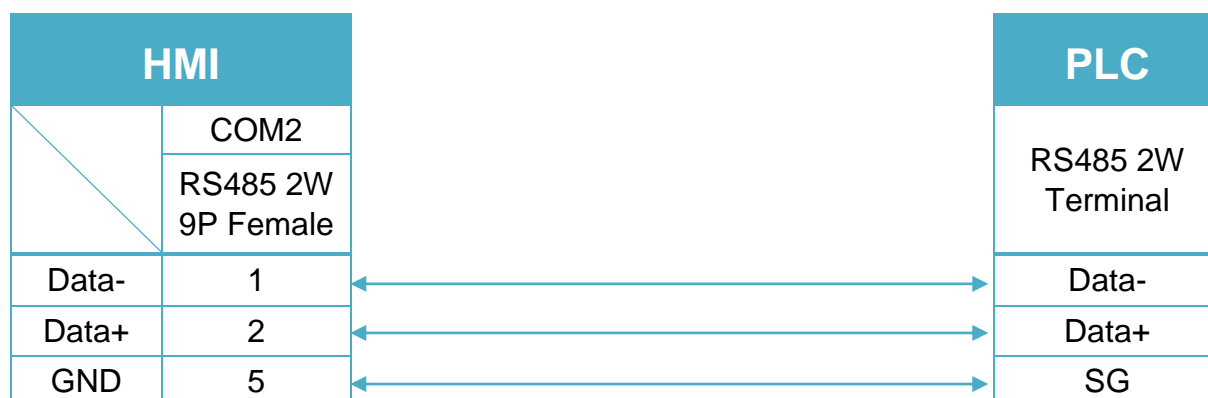


Diagram 6

MT-iP ***MT6071iP / MT8071iP***



DELTA AS300 MODBUS TCP/IP

Supported Series: DELTA AS300

Website: <http://www.deltadriver.com>

HMI Setting:

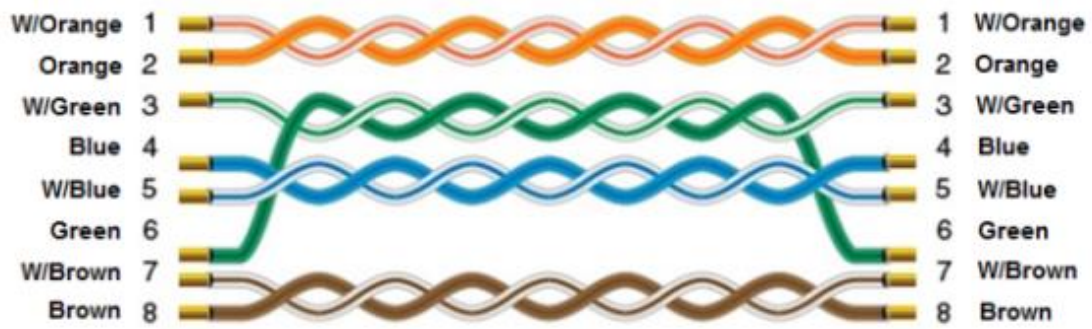
Parameters	Recommended	Options	Notes
PLC type	DELTA AS300 MODBUS TCP/IP		
PLC I/F	Ethernet		
Port no.	502		
PLC sta. no.	1		

Device Address:

Bit/Word	Device type	Format	Range	Memo
B	X_Bit	DDdd	0 ~ 6315	
B	Y_Bit	DDdd	0 ~ 6315	
B	M	DDDD	0 ~ 8191	
B	SM	DDDD	0 ~ 4095	
B	S	DDDD	0 ~ 2047	
B	T_Flag	DDD	0 ~ 511	
B	C_Flag	DDD	0 ~ 511	
B	HC_Flag	DDD	0 ~ 255	
B	D_Bit	DDDDDdd	0 ~ 2999915	
W	X	DD	0 ~ 63	
W	Y	DD	0 ~ 63	
W	SR	DDDD	0 ~ 2047	
W	D	DDDDD	0 ~ 29999	
W	T	DDD	0 ~ 511	
W	C	DDD	0 ~ 511	
DW	HC	DDD	0 ~ 255	
W	E	D	0 ~ 9	

Wiring Diagram:

Ethernet cable:



DELTA DVP

Supported Series: DELTA DVP series

Website: <http://www.deltadriver.com>

HMI Setting:

Parameters	Recommended	Options	Notes
PLC type	DELTA DVP		
PLC I/F	RS232	RS232, RS485	
Baud rate	9600	9600, 19200	
Data bits	7	7, 8	
Parity	Even	Even, Odd, None	
Stop bits	1	1	
PLC sta. no.	1	0-255	

*Support communications between HMI and PLC in pass-through mode

*Set LW-9903 to 2 to enhance the speed of download/upload PLC program in pass-through mode

Device Address:

Bit/Word	Device type	Format	Range	Memo
B	X	OOOOO	0 ~ 23417 (octal)	Input
B	Y	OOOOO	0 ~ 23417 (octal)	Output
B	M	DDDDD	0 ~ 65536	Auxiliary Relay
B	S	DDDD	0 ~ 9999	Step Relay
B	T	DDDD	0 ~ 9999	Timer
B	C	DDDD	0 ~ 9999	Counter
B	TV_Bit	DDDDdd	0 ~ 999915	Timer
W	TV	DDDD	0 ~ 9999	Timer
W	CV	DDD	0 ~ 199	Counter
W	CV2	DDD	200 ~ 255	Double Word Counter
W	D	DDDDD	0 ~ 11999	Data Register

Wiring Diagram:

The following is the view from the soldering point of a connector.



RS-232 8P Mini-DIN (Diagram 1 ~ Diagram 3)

Diagram 1

cMT Series	cMT3151
eMT Series	eMT3070 / eMT3105 / eMT3120 / eMT3150
MT-iE	MT8073iE / MT8102iE
MT-XE	MT8092XE
MT-iP	MT6103iP

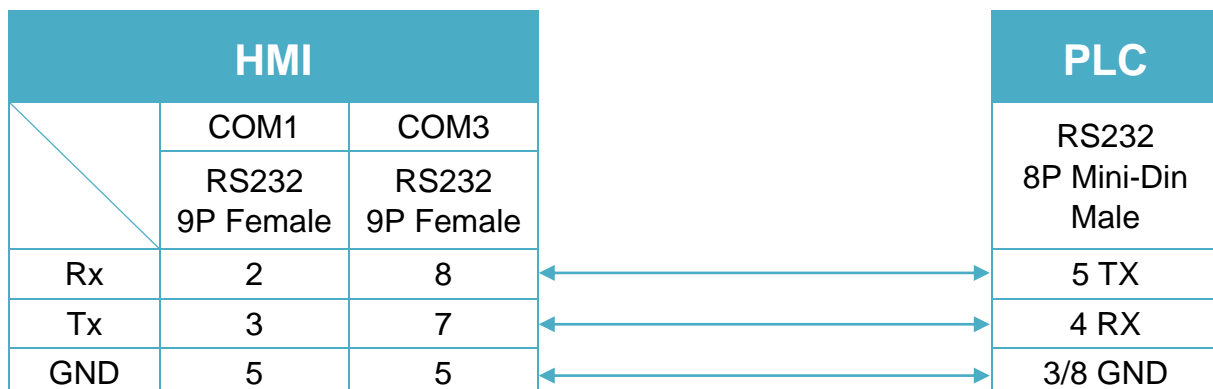


Diagram 2

cMT Series	cMT-SVR
mTV	mTV
MT-iE	MT8070iE / MT6070iE / MT8100iE / MT8121iE / MT8150iE / MT8071iE / MT6071iE / MT8072iE / MT6072iE / MT8073iE / MT8101iE / MT8102iE / MT8103iE
MT-XE	MT8121XE / MT8150XE / MT8090XE

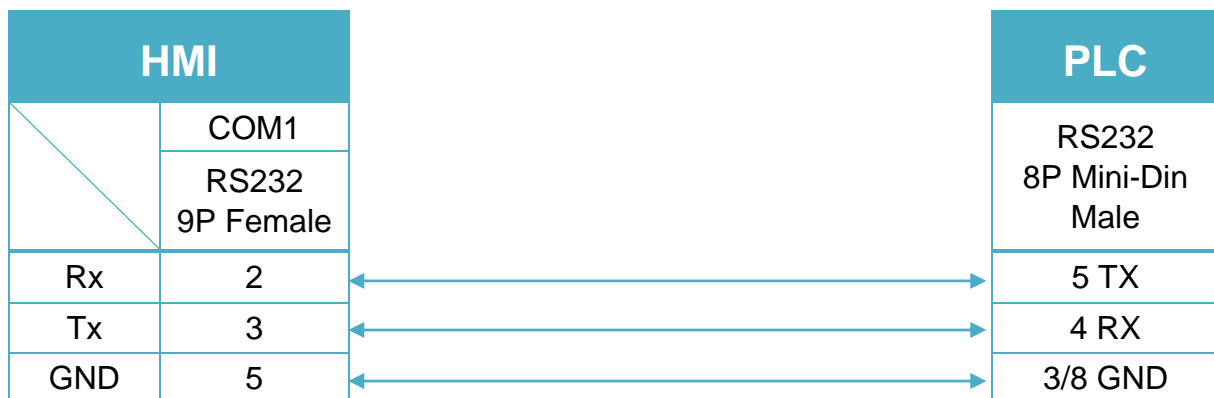
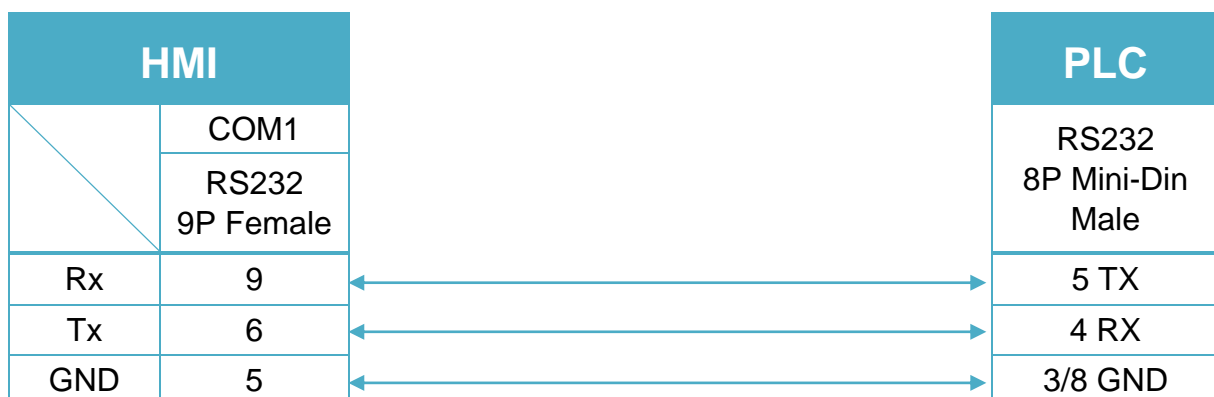
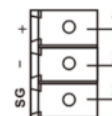


Diagram 3

MT-iE	MT8050iE
MT-iP	MT6051iP / MT6071iP / MT8071iP





RS-485 2W (Diagram 4 ~ Diagram 9)

Diagram 4

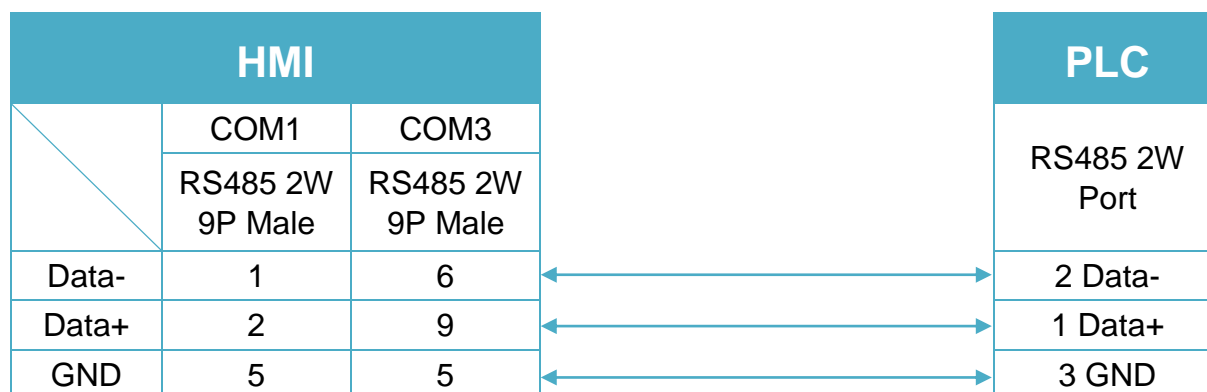
cMT Series
cMT3151
eMT Series
eMT3070 / eMT3105 / eMT3120 / eMT3150


Diagram 5

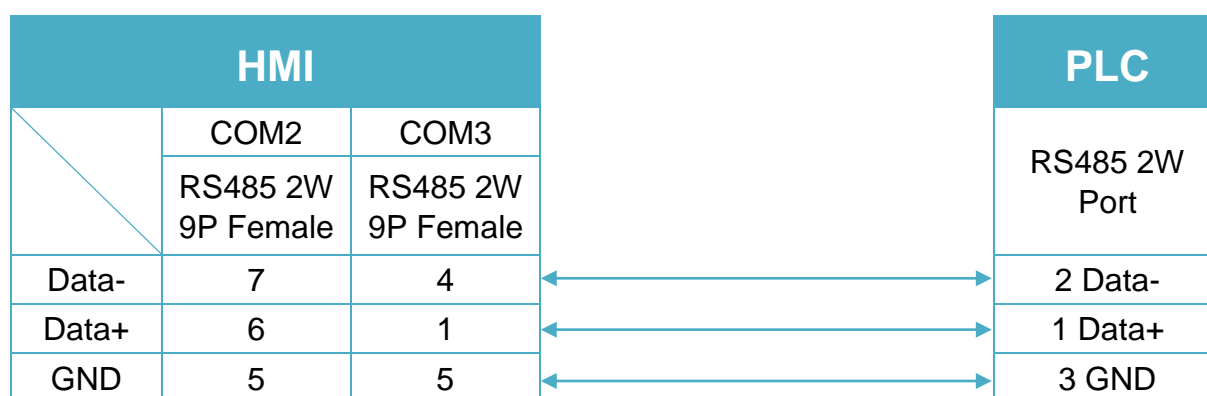
cMT Series
cMT-SVR
mTV
mTV


Diagram 6

MT-iE *MT8070iE / MT6070iE / MT8100iE / MT8121iE / MT8150iE*

MT-XE *MT8121XE / MT8150XE*

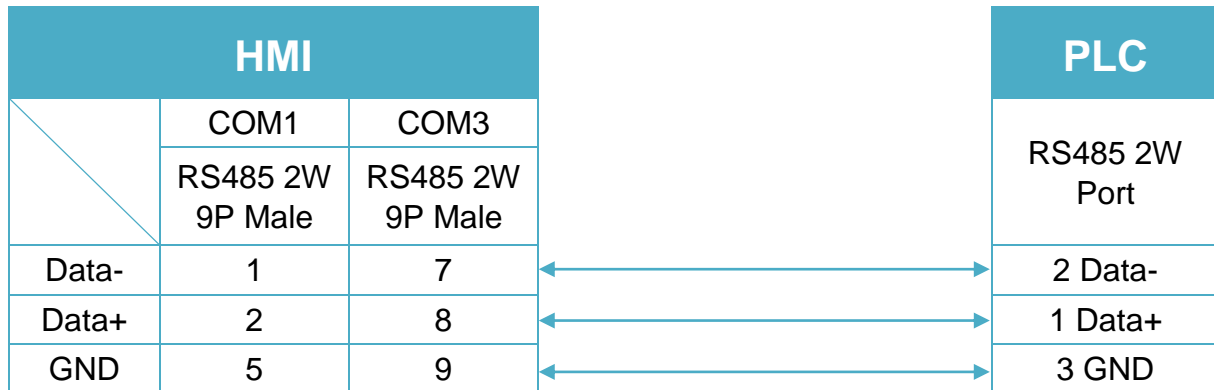


Diagram 7

MT-iE *MT8071iE / MT6071iE / MT8072iE / MT6072iE / MT8073iE / MT8101iE / MT8102iE / MT8103iE*

MT-XE *MT8090XE / MT8092XE*

MT-iP *MT6103iP*

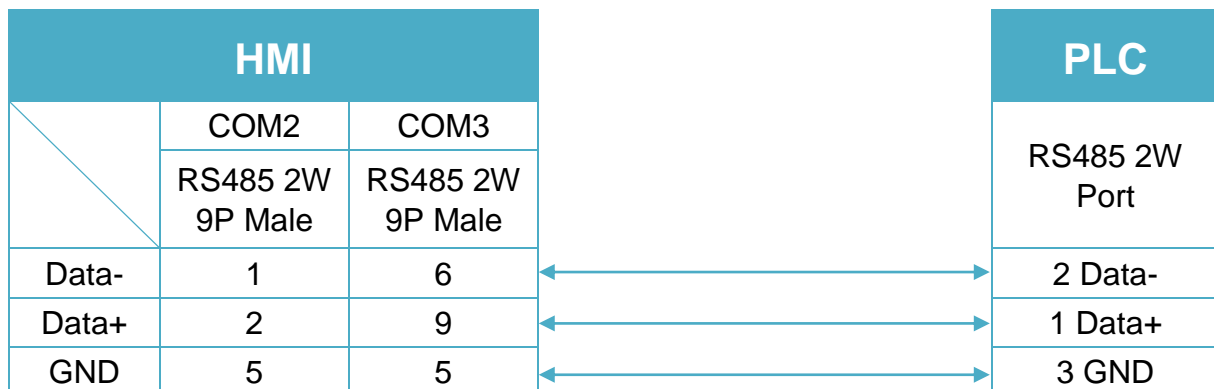


Diagram 8

MT-iE *MT8050iE*

MT-iP *MT6051iP*

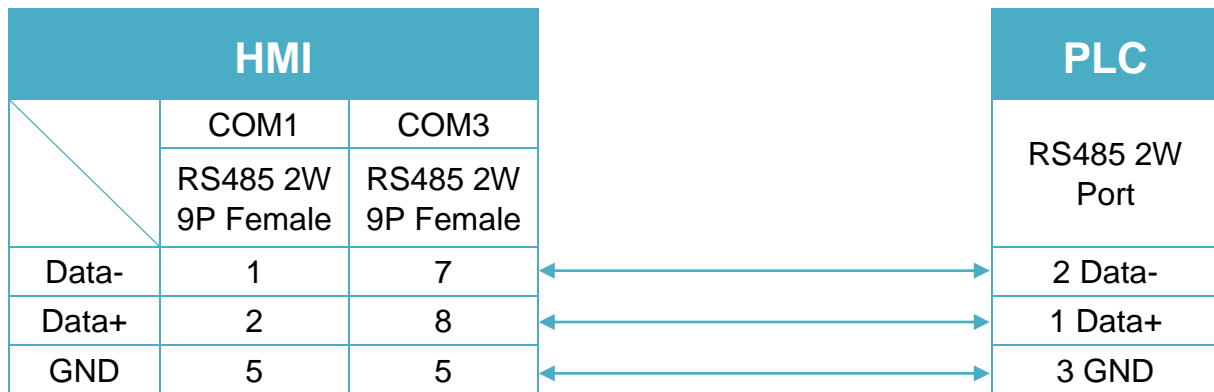
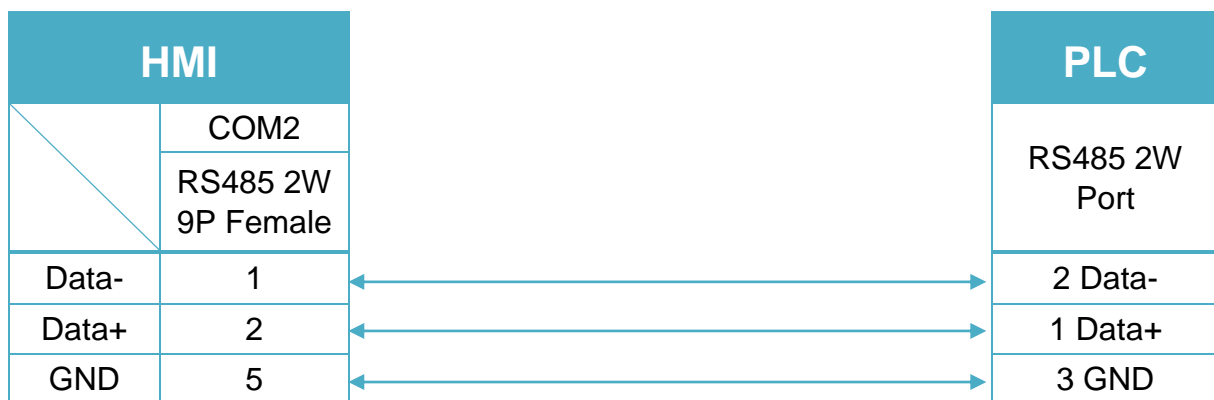


Diagram 9

MT-iP *MT6071iP / MT8071iP*



DELTA DVPEN01-SL (Ethernet)

Website: <http://www.deltadrivers.com>

HMI Setting:

Parameters	Recommended	Options	Notes
PLC type	DELTA DVPEN01-SL (Ethernet)		
PLC I/F	Ethernet		
Port no.	502		
PLC sta. no.	0		

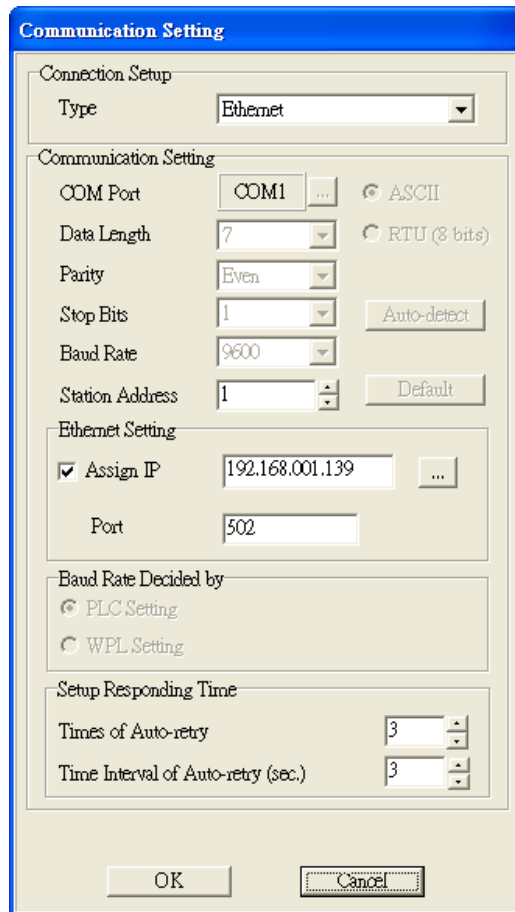
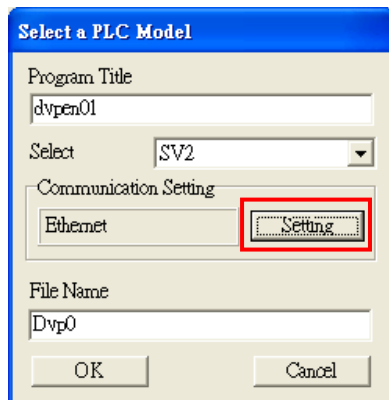
Device Address:

Bit/Word	Device type	Format	Range	Memo
B	C_Bit	DDD	0 ~ 255	
B	M	DDDD	0 ~ 4095	
B	S	DDDD	0 ~ 1023	
B	T_Bit	DDD	0 ~ 255	
B	X	OOO	0 ~ 571	
B	Y	OOO	0 ~ 571	
W	C	DDD	0 ~ 199	
DW	C_32Bit	DDD	200 ~ 255	
W	D	DDDDD	0 ~ 11999	
W	T	DDD	0 ~ 255	

PLC Setting:

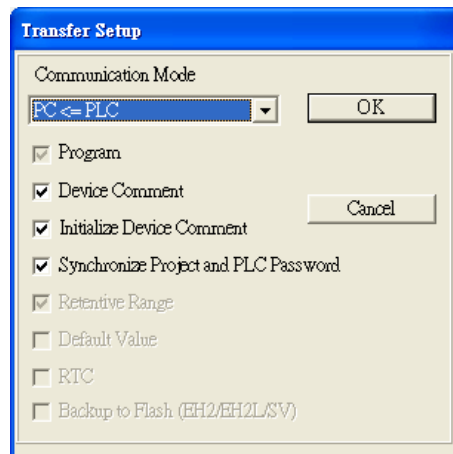
1. Communication Setting

Add a new program, click **File > New**, enter the **Program Title** and **File Name**, and select the correct controller type. Click **Setting** to configure the communication parameters. Click **OK** to confirm the setting. The communication with PLC starts.



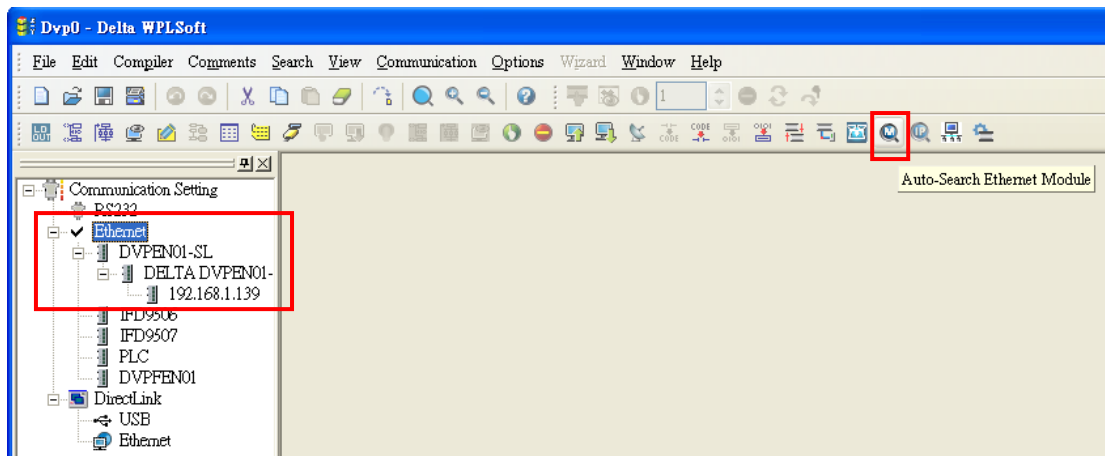
2. Transfer Setup

Click **Communication** and select **PC<=>(PLC | HPP)**, on **Transfer Setup** dialog box, select the needed parameters for upload or download, and click **OK** to start the action.



3. Auto-Search Ethernet Module

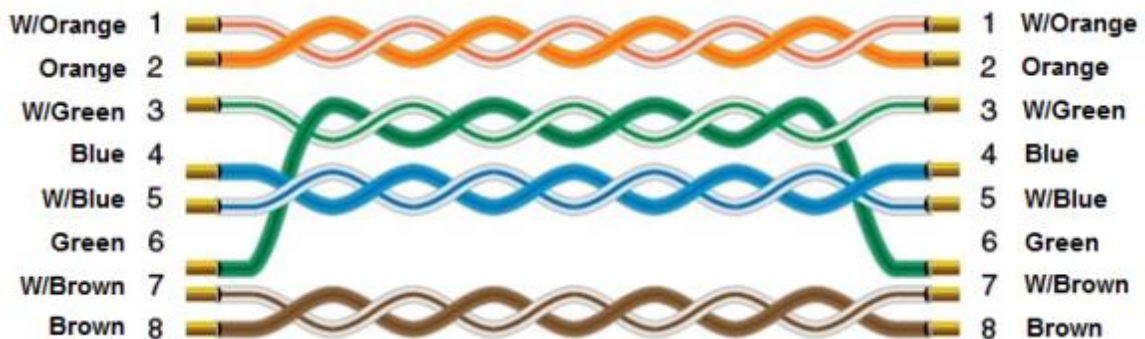
Click **Auto-Search Ethernet Module** to find the PLC modules on the same network. As shown in the following figure, DVPEN01-SL, IP address 192.168.1.139 is found.



Wiring Diagram:

Diagram 1

Ethernet cable:



DELTA Ethernet/IP (AS Series)

Supported Series: Delta AS332T

Website: <http://www.deltadrivers.com>

HMI Setting:

Parameters	Recommended	Options	Notes
PLC type	DELTA Ethernet/IP (AS Series)		
PLC I/F	Ethernet		
Port no.	44818		

Device Address:

Bit/Word	Device type	Format	Range	Memo
B	X_Bit	DDdd	0 ~ 6315	
B	Y_Bit	DDdd	0 ~ 6315	
B	D_Bit	DDDDdd	0 ~ 2999915	
B	M	DDDD	0 ~ 8191	
B	S	DDDD	0 ~ 2047	
B	T_Flag	DDD	0 ~ 511	
B	C_Flag	DDD	0 ~ 511	
B	HC_Flag	DDD	0 ~ 255	
B	SM	DDDD	0 ~ 4095	
W	X	DD	0 ~ 63	
W	Y	DD	0 ~ 63	
W	D	DDDDD	0 ~ 29999	
W	T	DDD	0 ~ 511	
W	C	DDD	0 ~ 511	
DW	HC	DDD	0 ~ 255	
W	SR	DDD	0 ~ 2047	
W	E	D	0 ~ 8	

Wiring Diagram:

Ethernet cable



DL-BCM Server

Website: <http://www.hzdelin.com>

HMI Setting:

Parameters	Recommended	Options	Notes
PLC type	DL-BCM Server		
PLC I/F	RS232	RS232, RS485	
Baud rate	9600	9600~115200	
Data bits	8	8	
Parity	None	Even, Odd, None	
Stop bits	1	1	
PLC sta. no.	0	0-31	

Device Address:

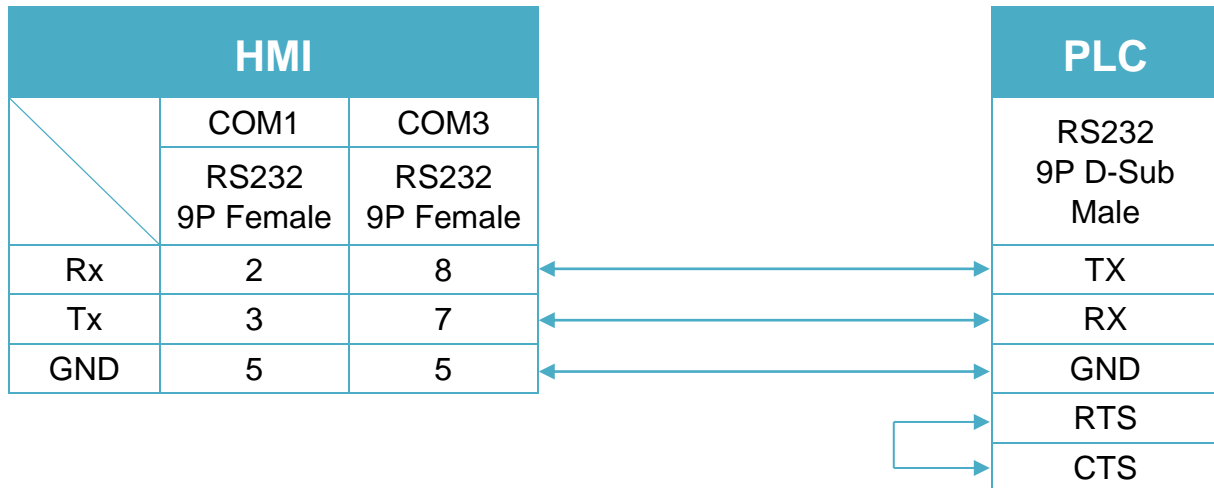
Bit/Word	Device type	Format	Range	Memo
B	LB	dddd	0 ~ 9998	
W	LW	dddd	0 ~ 9998	
W	RW	dddddd	0 ~ 55536	

Wiring Diagram:

RS-232 9P D-Sub (Diagram 1 ~ Diagram 3)

Diagram 1

cMT Series	<i>cMT3151</i>
eMT Series	<i>eMT3070 / eMT3105 / eMT3120 / eMT3150</i>
MT-iE	<i>MT8073iE / MT8102iE</i>
MT-XE	<i>MT8092XE</i>
MT-iP	<i>MT6103iP</i>


Diagram 2

cMT Series	cMT-SVR
mTV	mTV
MT-iE	MT8070iE / MT6070iE / MT8100iE / MT8121iE / MT8150iE / MT8071iE / MT6071iE / MT8072iE / MT6072iE / MT8073iE / MT8101iE / MT8102iE / MT8103iE
MT-XE	MT8121XE / MT8150XE / MT8090XE

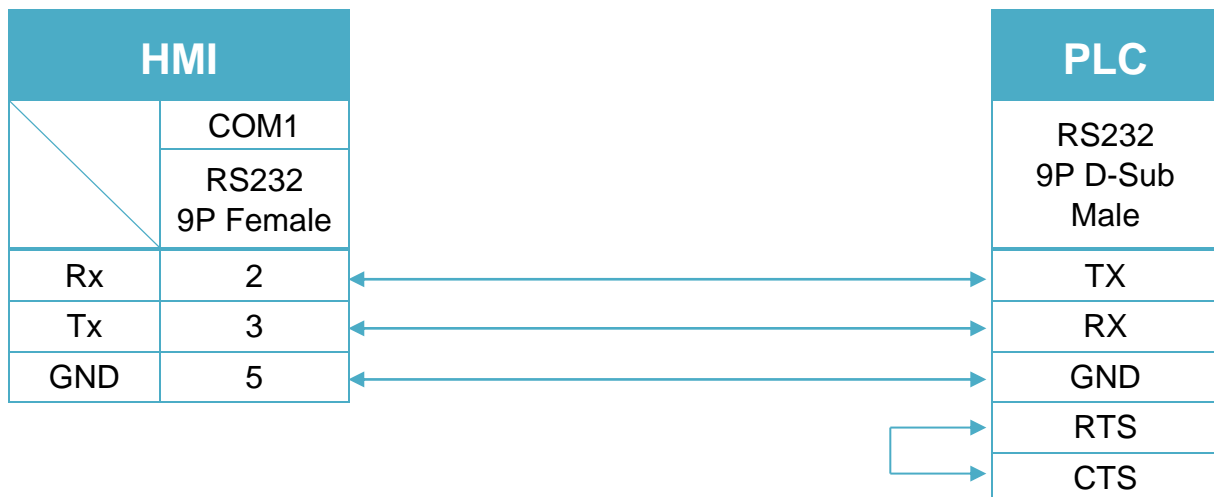
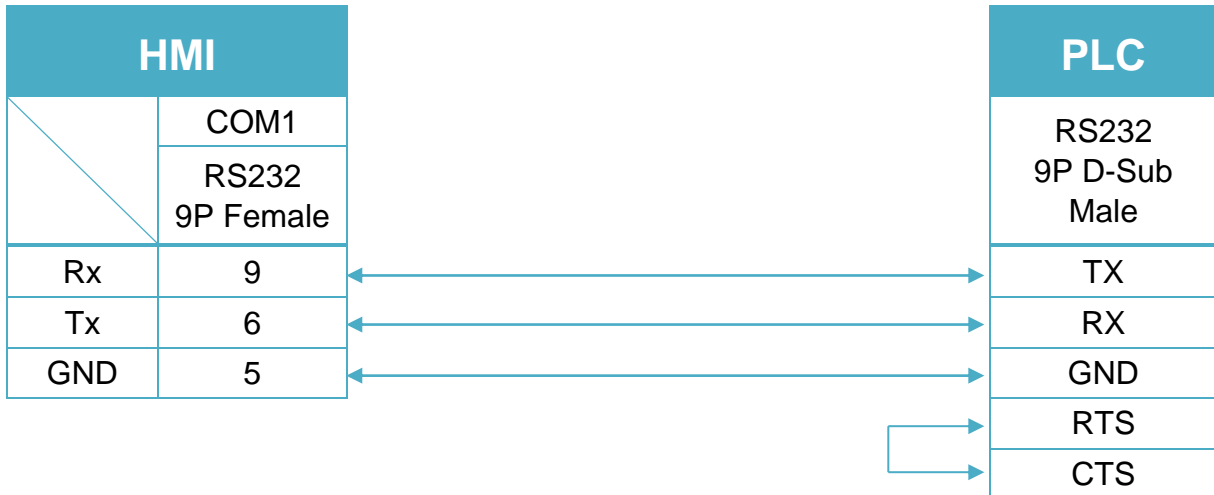


Diagram 3

MT-iE
MT8050iE
MT-iP
MT6051iP / MT6071iP / MT8071iP


RS-485 2W 9P D-Sub (Diagram 4 ~ Diagram 9)

Diagram 4

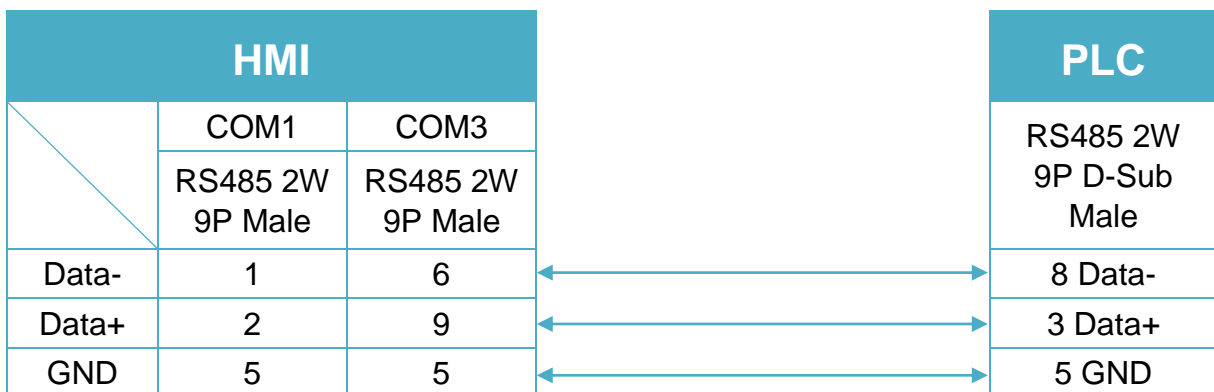
cMT Series
cMT3151
eMT Series
eMT3070 / eMT3105 / eMT3120 / eMT3150


Diagram 5

cMT Series *cMT-SVR*

mTV *mTV*

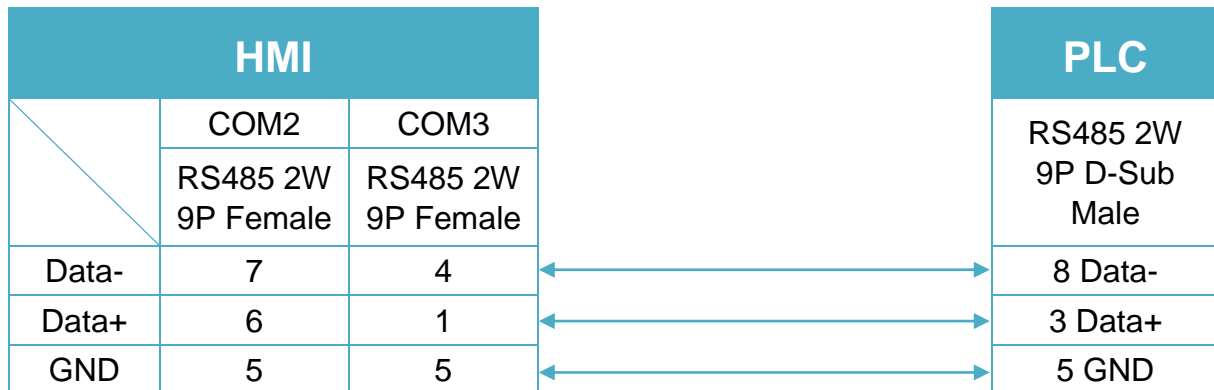


Diagram 6

MT-iE *MT8070iE / MT6070iE / MT8100iE / MT8121iE / MT8150iE*

MT-XE *MT8121XE / MT8150XE*

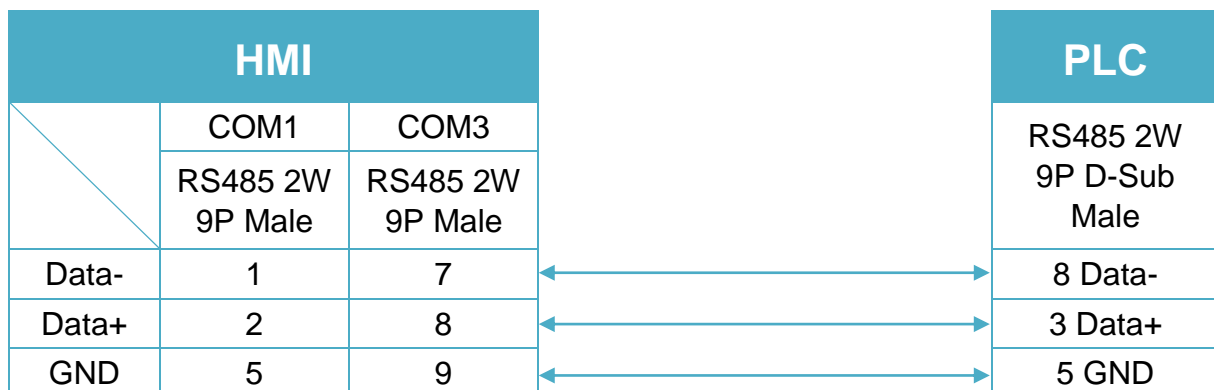


Diagram 7

MT-iE	<i>MT8071iE / MT6071iE / MT8072iE / MT6072iE / MT8073iE / MT8101iE / MT8102iE / MT8103iE</i>
MT-XE	<i>MT8090XE / MT8092XE</i>
MT-iP	<i>MT6103iP</i>

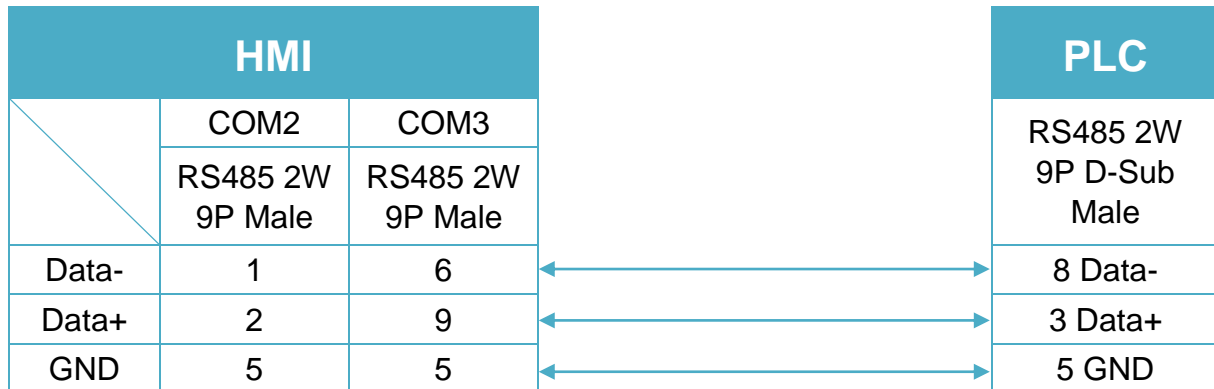


Diagram 8

MT-iE	<i>MT8050iE</i>
MT-iP	<i>MT6051iP</i>

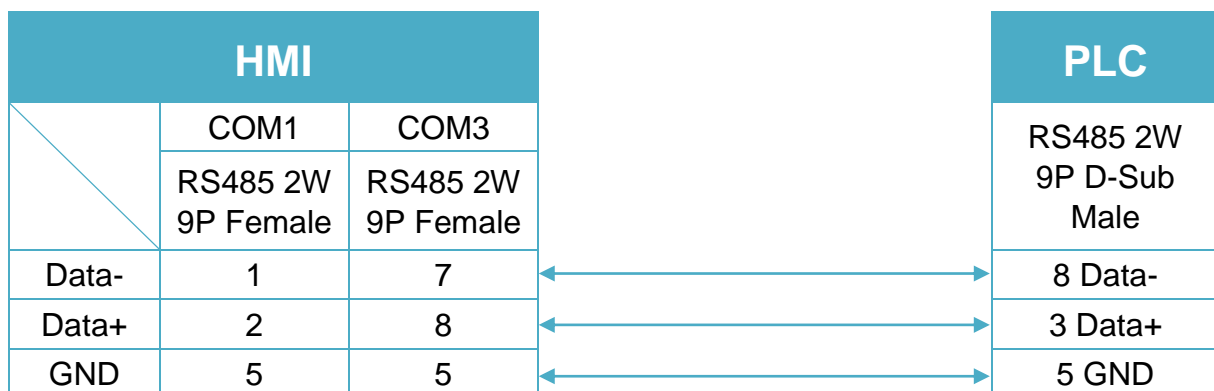
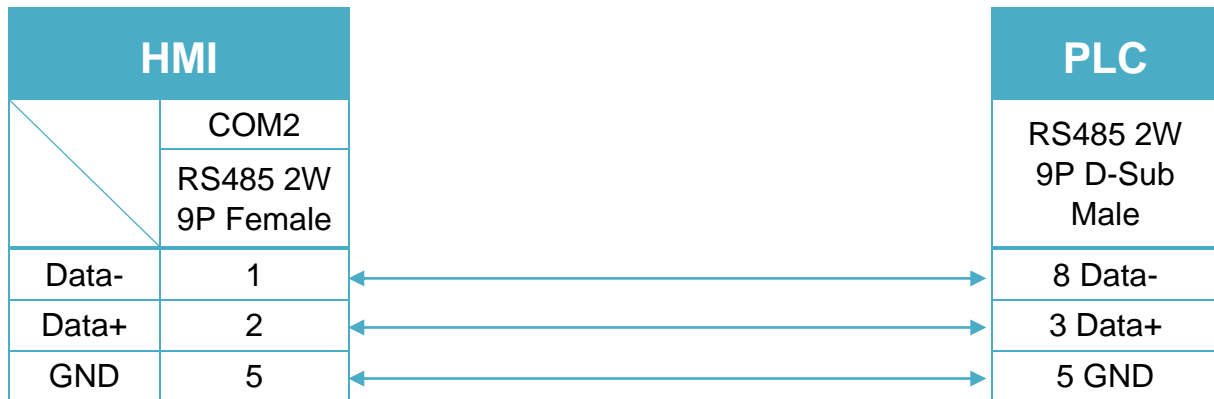


Diagram 9

MT-iP
MT6071iP / MT8071iP


DL/T645 CHUANG HONG

Website: <http://www.cw180.com>

HMI Setting:

Parameters	Recommended	Options	Notes
PLC type	DL/T645 CHUANG HONG		
PLC I/F	RS485 2W		
Baud rate	9600		
Data bits	8		
Parity	Even		
Stop bits	1		
PLC sta. no.	1		

Device Address:

Bit/Word	Device type	Format	Range	Memo
W	B621	D	0 ~ 1	
W	B622	D	0 ~ 1	
W	B623	D	0 ~ 1	
W	zero phase	D	0 ~ 1	
W	B611	D	0 ~ 1	
W	B612	D	0 ~ 1	
W	B613	D	0 ~ 1	
W	B631	D	0 ~ 1	
W	B632	D	0 ~ 1	
W	B633	D	0 ~ 1	
W	B630	D	0 ~ 1	
W	B641	D	0 ~ 1	
W	B642	D	0 ~ 1	
W	B643	D	0 ~ 1	
W	B640	D	0 ~ 1	
W	A-apparentT	D	0 ~ 1	
W	B-apparentT	D	0 ~ 1	
W	C-apparentT	D	0 ~ 1	
W	T-apparentT	D	0 ~ 1	
W	B650	D	0 ~ 1	
W	B651	D	0 ~ 1	
W	B652	D	0 ~ 1	

Bit/Word	Device type	Format	Range	Memo
W	B653	D	0 ~ 1	
W	9010	D	0 ~ 1	
W	9020	D	0 ~ 1	
W	9110	D	0 ~ 1	
W	9120	D	0 ~ 1	
W	9130	D	0 ~ 1	
W	9140	D	0 ~ 1	
W	9150	D	0 ~ 1	
W	9160	D	0 ~ 1	
W	9410	D	0 ~ 1	
W	9420	D	0 ~ 1	
W	9510	D	0 ~ 1	
W	9520	D	0 ~ 1	
W	9530	D	0 ~ 1	
W	9540	D	0 ~ 1	
W	9550	D	0 ~ 1	
W	9560	D	0 ~ 1	
W	9810	D	0 ~ 1	
W	9820	D	0 ~ 1	
W	9910	D	0 ~ 1	
W	9920	D	0 ~ 1	
W	9930	D	0 ~ 1	
W	9940	D	0 ~ 1	
W	9950	D	0 ~ 1	
W	9960	D	0 ~ 1	
W	A010	D	0 ~ 1	
W	A020	D	0 ~ 1	
W	A110	D	0 ~ 1	
W	A120	D	0 ~ 1	
W	A130	D	0 ~ 1	
W	A140	D	0 ~ 1	
W	A150	D	0 ~ 1	
W	A160	D	0 ~ 1	
W	A410	D	0 ~ 1	
W	A420	D	0 ~ 1	
W	A510	D	0 ~ 1	
W	A520	D	0 ~ 1	
W	A530	D	0 ~ 1	
W	A540	D	0 ~ 1	
W	A550	D	0 ~ 1	

Bit/Word	Device type	Format	Range	Memo
W	A560	D	0 ~ 1	
W	A810	D	0 ~ 1	
W	A820	D	0 ~ 1	
W	A910	D	0 ~ 1	
W	A920	D	0 ~ 1	
W	A930	D	0 ~ 1	
W	A940	D	0 ~ 1	
W	A950	D	0 ~ 1	
W	A960	D	0 ~ 1	
W	B010	D	0 ~ 1	
W	B020	D	0 ~ 1	
W	B110	D	0 ~ 1	
W	B120	D	0 ~ 1	
W	B130	D	0 ~ 1	
W	B140	D	0 ~ 1	
W	B150	D	0 ~ 1	
W	B160	D	0 ~ 1	
W	B410	D	0 ~ 1	
W	B420	D	0 ~ 1	
W	B510	D	0 ~ 1	
W	B520	D	0 ~ 1	
W	B530	D	0 ~ 1	
W	B540	D	0 ~ 1	
W	B550	D	0 ~ 1	
W	B560	D	0 ~ 1	
W	B810	D	0 ~ 1	
W	B820	D	0 ~ 1	
W	B910	D	0 ~ 1	
W	B920	D	0 ~ 1	
W	B930	D	0 ~ 1	
W	B940	D	0 ~ 1	
W	B950	D	0 ~ 1	
W	B960	D	0 ~ 1	
W	B210	D	0 ~ 1	
W	B211	D	0 ~ 1	
W	B212	D	0 ~ 1	
W	B213	D	0 ~ 1	
W	B214	D	0 ~ 1	
W	B310	D	0 ~ 1	
W	B311	D	0 ~ 1	

Bit/Word	Device type	Format	Range	Memo
W	B312	D	0 ~ 1	
W	B313	D	0 ~ 1	
W	B320	D	0 ~ 1	
W	B321	D	0 ~ 1	
W	B322	D	0 ~ 1	
W	B323	D	0 ~ 1	
W	B330	D	0 ~ 1	
W	B331	D	0 ~ 1	
W	B332	D	0 ~ 1	
W	B333	D	0 ~ 1	
W	B340	D	0 ~ 1	
W	B341	D	0 ~ 1	
W	B342	D	0 ~ 1	
W	B343	D	0 ~ 1	
W	C010	D	0 ~ 1	
W	C011	D	0 ~ 1	
W	C020	D	0 ~ 1	
W	C021	D	0 ~ 1	
W	C022	D	0 ~ 1	
W	C030	D	0 ~ 1	
W	C031	D	0 ~ 1	
W	C032	D	0 ~ 1	
W	C033	D	0 ~ 1	
W	C034	D	0 ~ 1	
W	C111	D	0 ~ 1	
W	C112	D	0 ~ 1	
W	C113	D	0 ~ 1	
W	C114	D	0 ~ 1	
W	C115	D	0 ~ 1	
W	C116	D	0 ~ 1	
W	C117	D	0 ~ 1	
W	C118	D	0 ~ 1	
W	C119	D	0 ~ 1	
W	C11A	D	0 ~ 1	
W	C211	D	0 ~ 1	
W	C212	D	0 ~ 1	
W	C310	D	0 ~ 1	
W	C311	D	0 ~ 1	
W	C312	D	0 ~ 1	
W	C313	D	0 ~ 1	

Bit/Word	Device type	Format	Range	Memo
W	C314	D	0 ~ 1	
W	C320	D	0 ~ 1	
W	C321	D	0 ~ 1	
W	C322	D	0 ~ 1	
W	C330	D	0 ~ 1	
W	C331	D	0 ~ 1	
W	C332	D	0 ~ 1	
W	C340	D	0 ~ 1	
W	C341	D	0 ~ 1	
W	C342	D	0 ~ 1	
W	C3A0	D	0 ~ 1	
W	C3A1	D	0 ~ 1	
W	C3A2	D	0 ~ 1	
W	C410	D	0 ~ 1	
W	C411	D	0 ~ 1	
W	C41E	D	0 ~ 1	
W	C510	D	0 ~ 1	
W	C511	D	0 ~ 1	
W	B634	D	0 ~ 1	
W	B635	D	0 ~ 1	

Wiring Diagram:

RS-485 2W Terminal (Diagram 1 ~ Diagram 6)

Diagram 1

cMT Series *cMT3151*

eMT Series *eMT3070 / eMT3105 / eMT3120 / eMT3150*

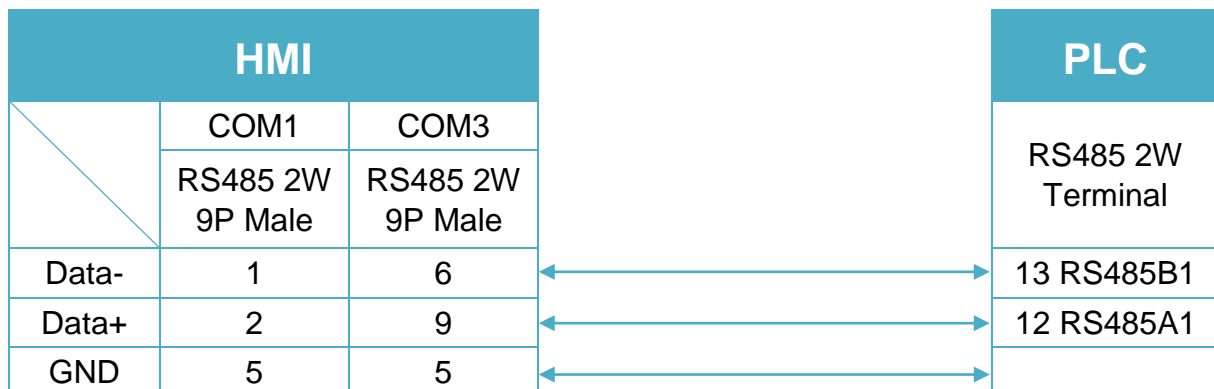


Diagram 2

cMT Series *cMT-SVR*

mTV *mTV*

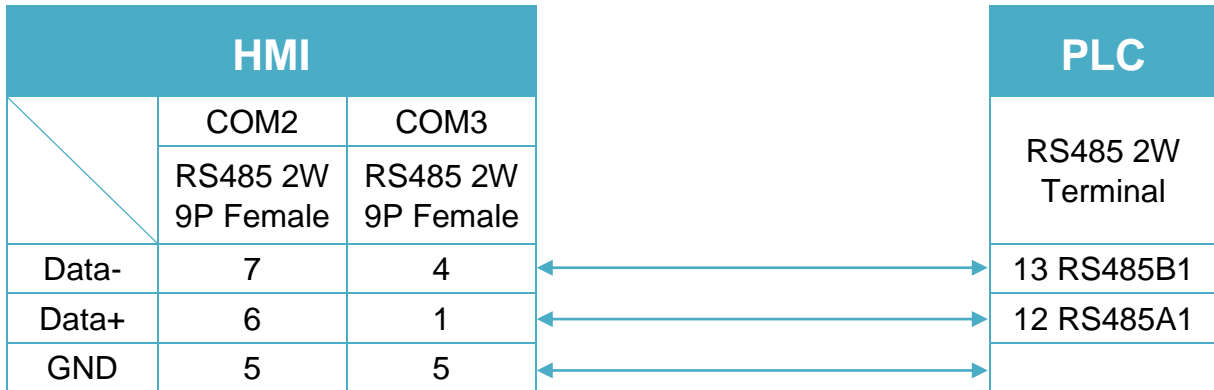


Diagram 3

MT-iE *MT8070iE / MT6070iE / MT8100iE / MT8121iE / MT8150iE*

MT-XE *MT8121XE / MT8150XE*

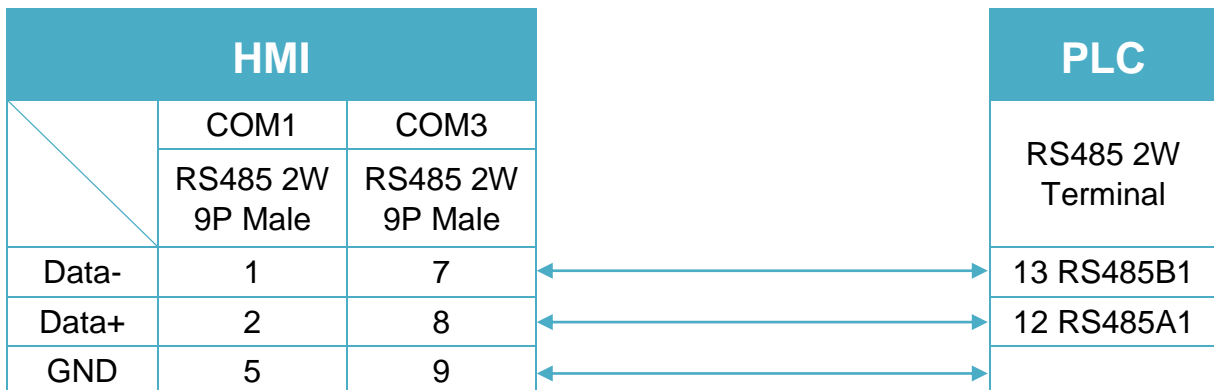


Diagram 4

MT-iE	<i>MT8071iE / MT6071iE / MT8072iE / MT6072iE / MT8073iE / MT8101iE / MT8102iE / MT8103iE</i>
MT-XE	<i>MT8090XE / MT8092XE</i>
MT-iP	<i>MT6103iP</i>

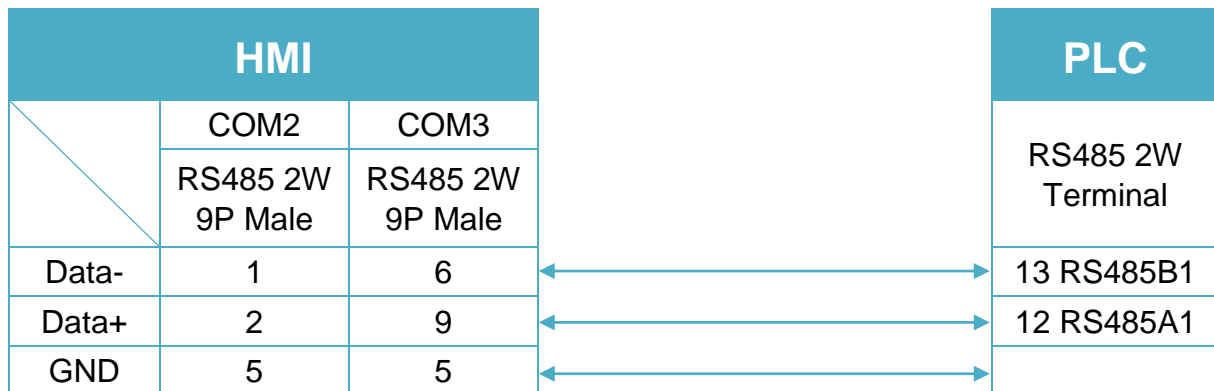


Diagram 5

MT-iE	<i>MT8050iE</i>
MT-iP	<i>MT6051iP</i>

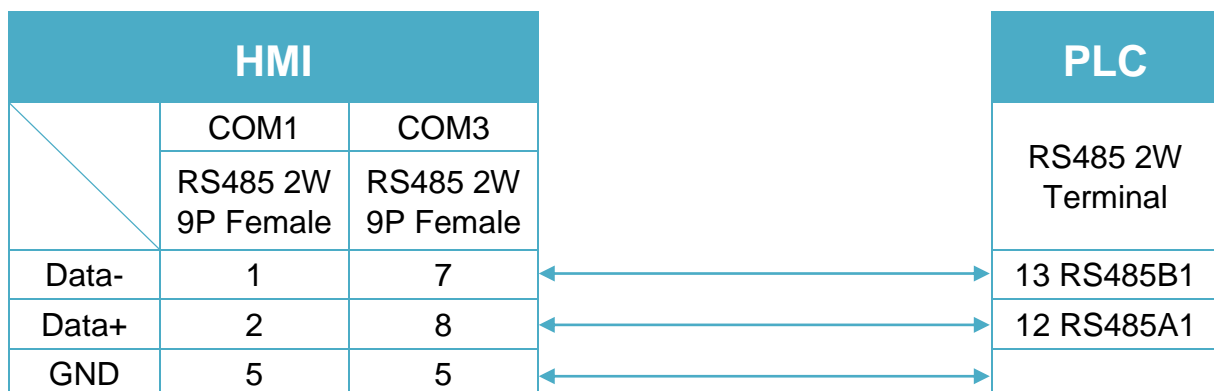
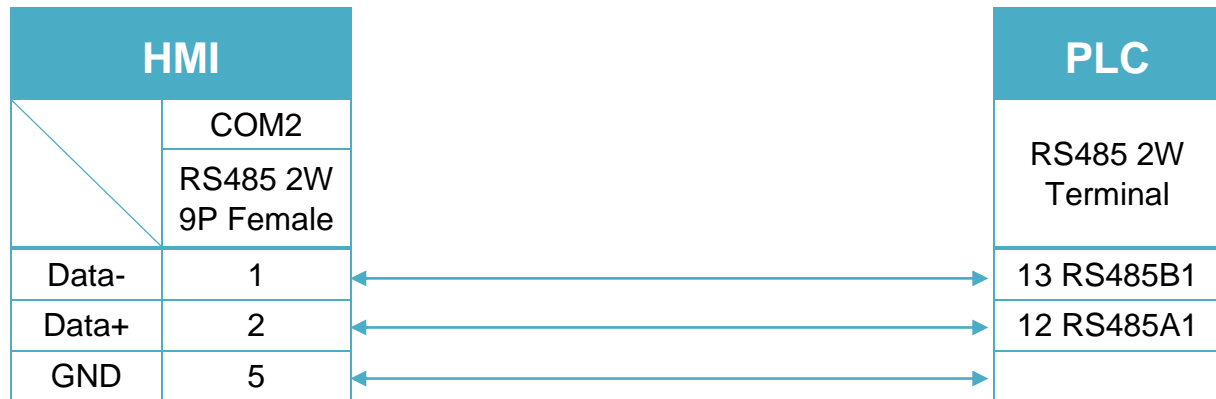


Diagram 6

MT-iP
MT6071iP / MT8071iP


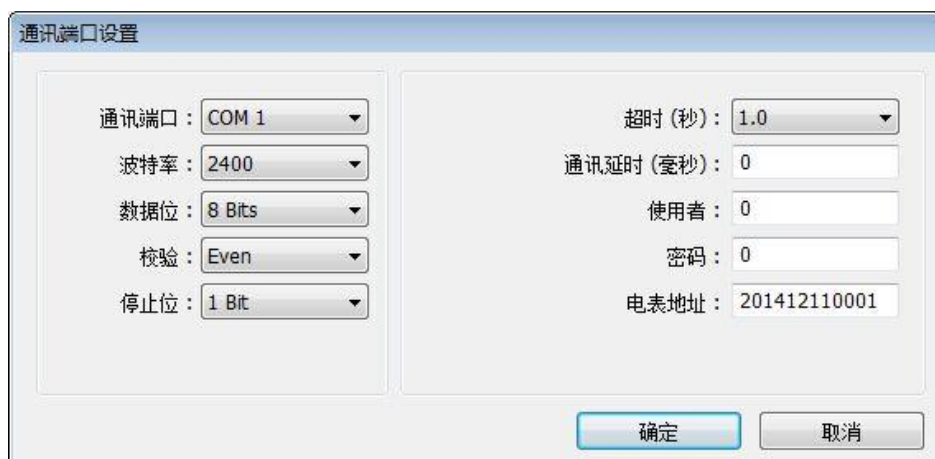
DL/T645 Standard

Website: <http://www.cw180.com>

HMI Setting:

Parameters	Recommended	Options	Notes
PLC type	DL/T645 Standard		
PLC I/F	RS485 2W		
Baud rate	9600		
Data bits	8		
Parity	Even		
Stop bits	1		
PLC sta. no.	1		

PLC Setting:

System Tag:

LW-10700 (4 words)	DLT_645 operator (COM 1)
LW-10704 (4 words)	DLT_645 password (COM 1)
LW-10708 (6 words)	DLT_645 address (COM 1)
LW-10715 (4 words)	DLT_645 operator (COM 2)
LW-10719 (4 words)	DLT_645 password (COM 2)
LW-10723 (6 words)	DLT_645 address (COM 2)
LW-10730 (4 words)	DLT_645 operator (COM 3)
LW-10734 (4 words)	DLT_645 password (COM 3)
LW-10738 (6 words)	DLT_645 address (COM 3)

Device Address:

Bit/Word	Device type	Format	Range	Memo
W	Data	HHHHHHH	0 ~ 6FFFFFF	
DW	Data_Double	HHHHHHH	0 ~ 6FFFFFF	

Wiring Diagram:

RS-485 2W Terminal (Diagram 1 ~ Diagram 6)

Diagram 1

cMT Series

cMT3151

eMT Series

eMT3070 / eMT3105 / eMT3120 / eMT3150

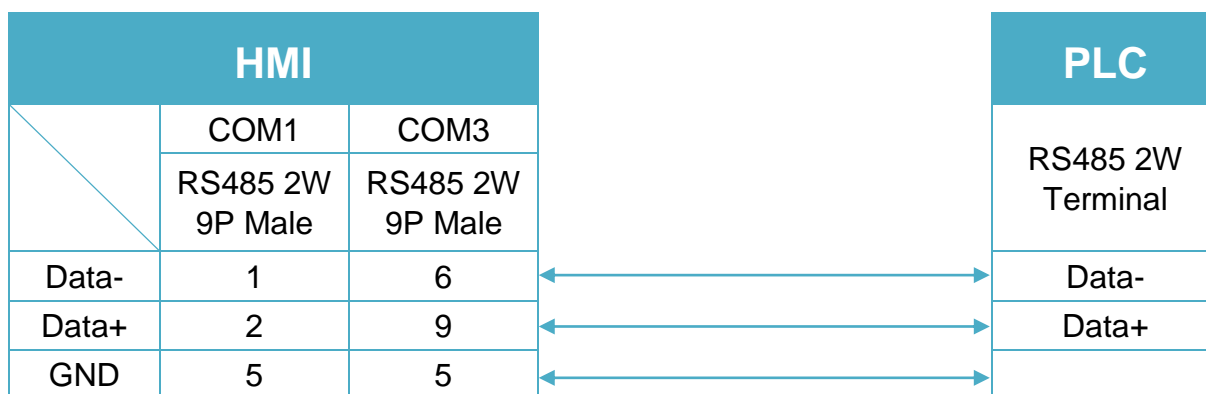


Diagram 2

cMT Series *cMT-SVR*

mTV *mTV*

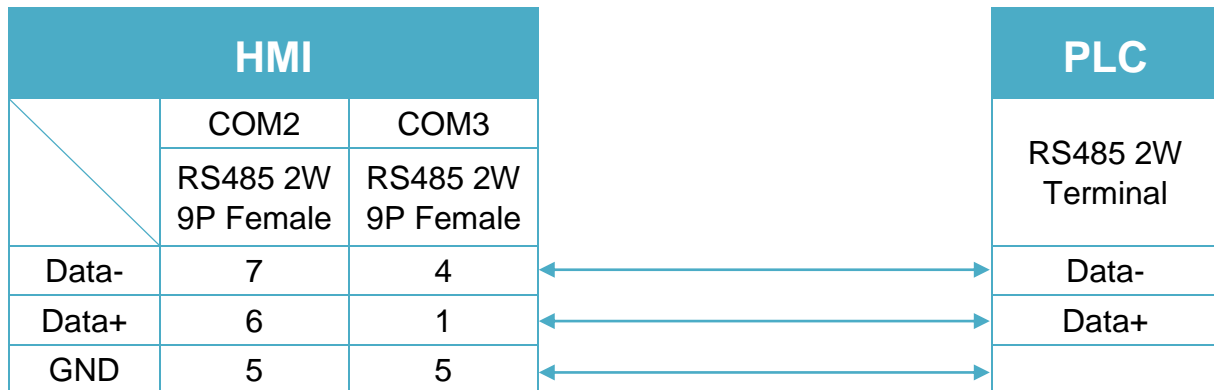


Diagram 3

MT-iE *MT8070iE / MT6070iE / MT8100iE / MT8121iE / MT8150iE*

MT-XE *MT8121XE / MT8150XE*

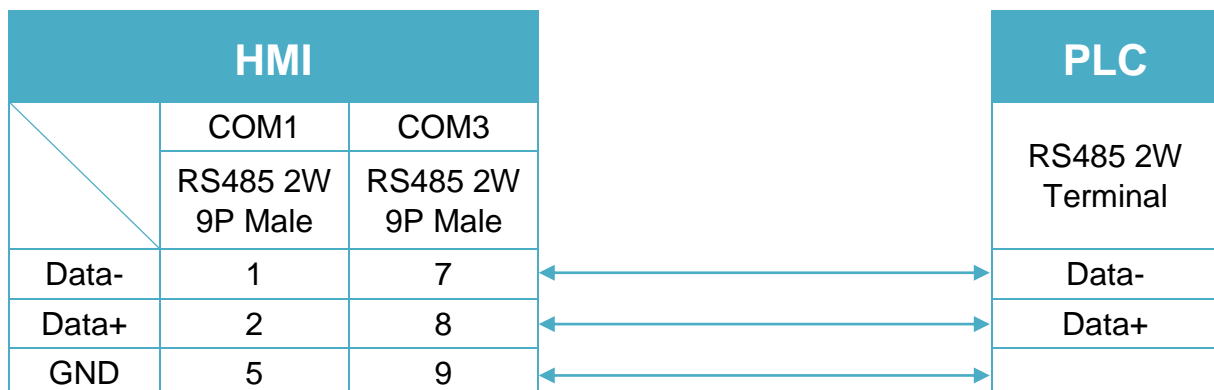
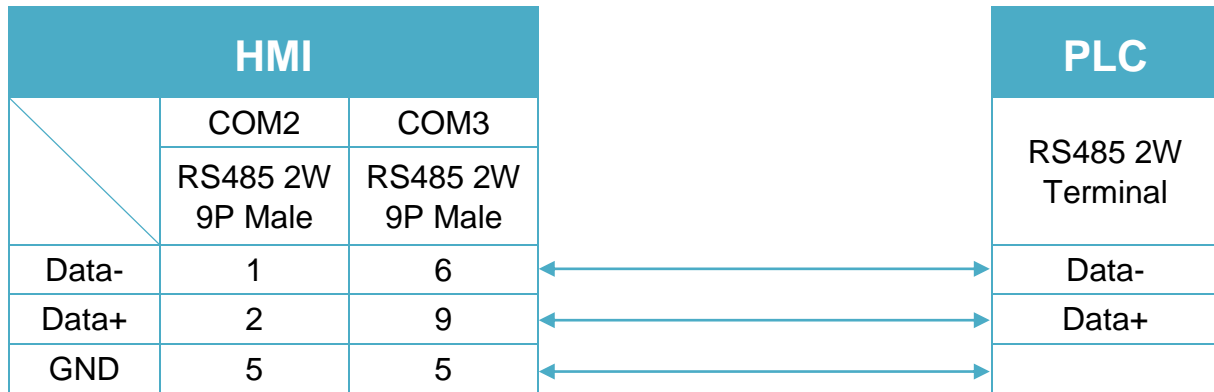
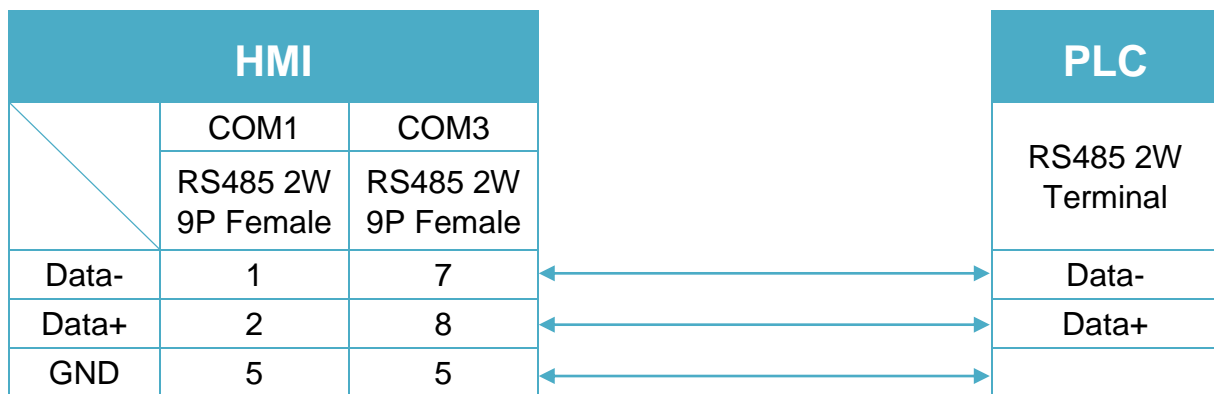


Diagram 4

MT-iE *MT8071iE / MT6071iE / MT8072iE / MT6072iE / MT8073iE / MT8101iE / MT8102iE / MT8103iE*

MT-XE *MT8090XE / MT8092XE*

MT-iP *MT6103iP*


Diagram 5
MT-iE *MT8050iE*
MT-iP *MT6051iP*

Diagram 6
MT-iP *MT6071iP / MT8071iP*

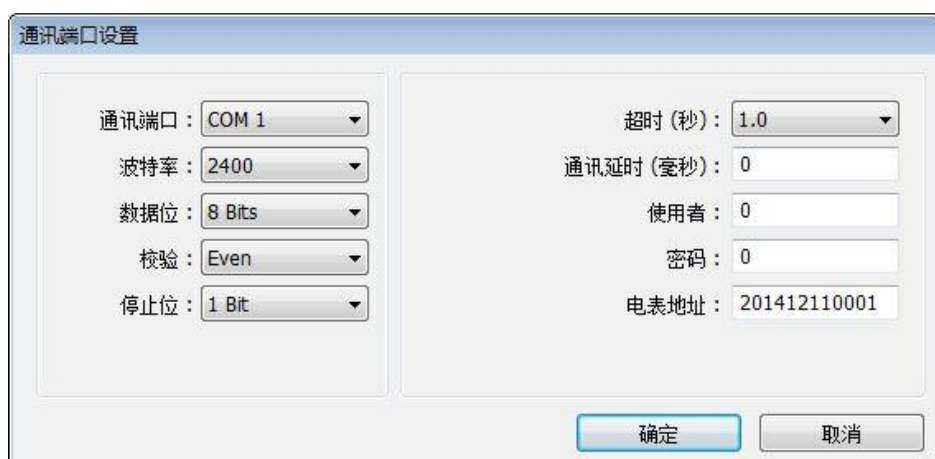

DL/T645-2007 Standard

Website: <http://www.cw180.com>

HMI Setting:

Parameters	Recommended	Options	Notes
PLC type	DL/T645-2007 Standard		
PLC I/F	RS485 2W		
Baud rate	9600		
Data bits	8		
Parity	Even		
Stop bits	1		
PLC sta. no.	1		

PLC Setting:

System Tag:

LW-10700 (4 words)	DLT_645 operator (COM 1)
LW-10704 (4 words)	DLT_645 password (COM 1)
LW-10708 (6 words)	DLT_645 address (COM 1)
LW-10715 (4 words)	DLT_645 operator (COM 2)
LW-10719 (4 words)	DLT_645 password (COM 2)
LW-10723 (6 words)	DLT_645 address (COM 2)
LW-10730 (4 words)	DLT_645 operator (COM 3)
LW-10734 (4 words)	DLT_645 password (COM 3)
LW-10738 (6 words)	DLT_645 address (COM 3)

Device Address:

Bit/Word	Device type	Format	Range	Memo
W	Data	HHHHHHH	0 ~ 6FFFFFF	

Wiring Diagram:

RS-485 2W Terminal (Diagram 1 ~ Diagram 6)

Diagram 1

cMT Series

cMT3151

eMT Series

eMT3070 / eMT3105 / eMT3120 / eMT3150

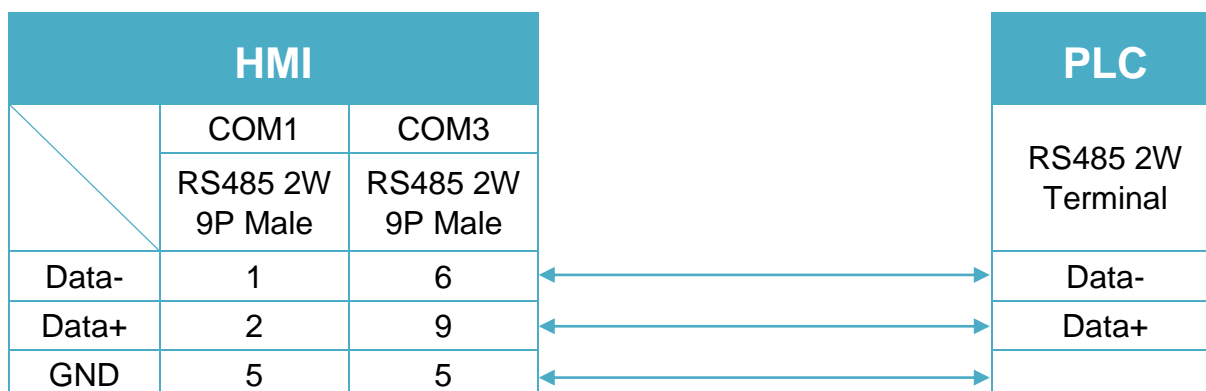


Diagram 2

cMT Series *cMT-SVR*

mTV *mTV*

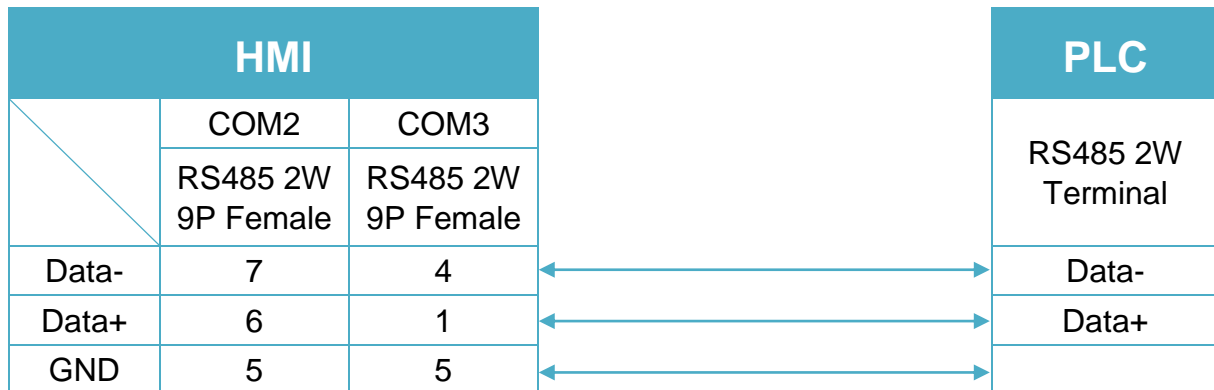


Diagram 3

MT-iE *MT8070iE / MT6070iE / MT8100iE / MT8121iE / MT8150iE*

MT-XE *MT8121XE / MT8150XE*

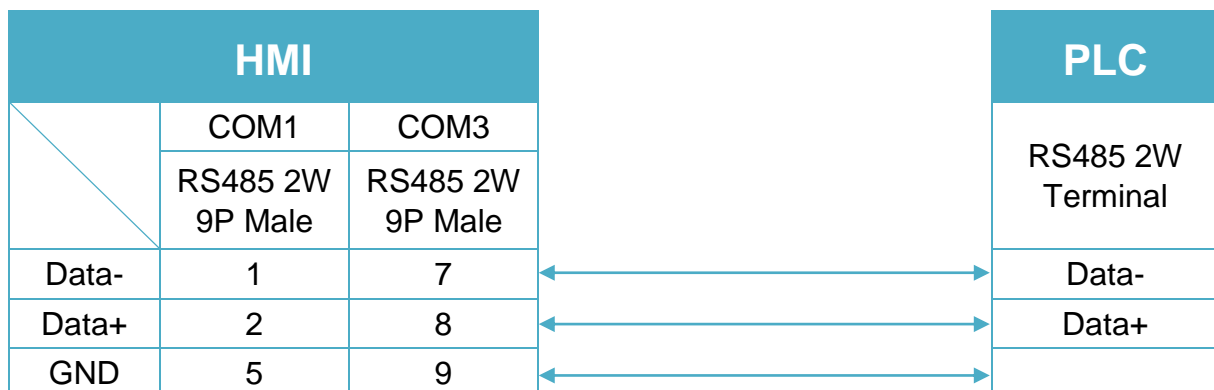
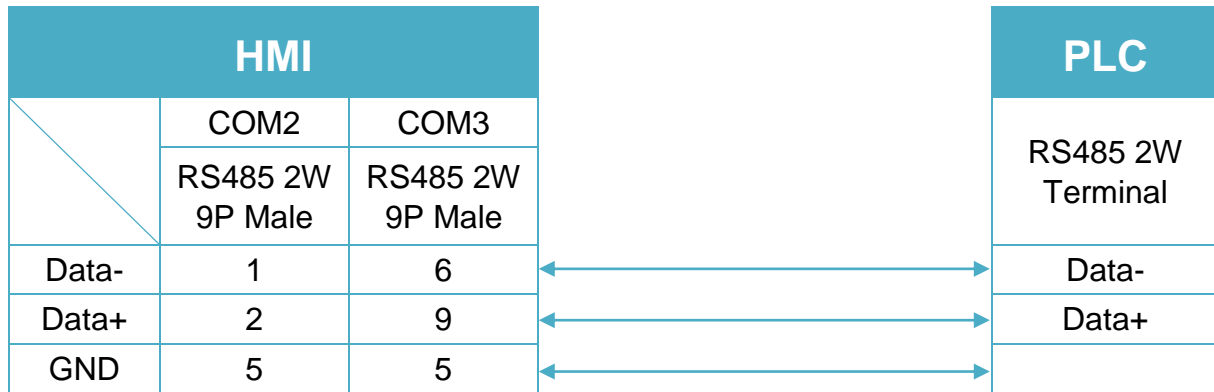


Diagram 4

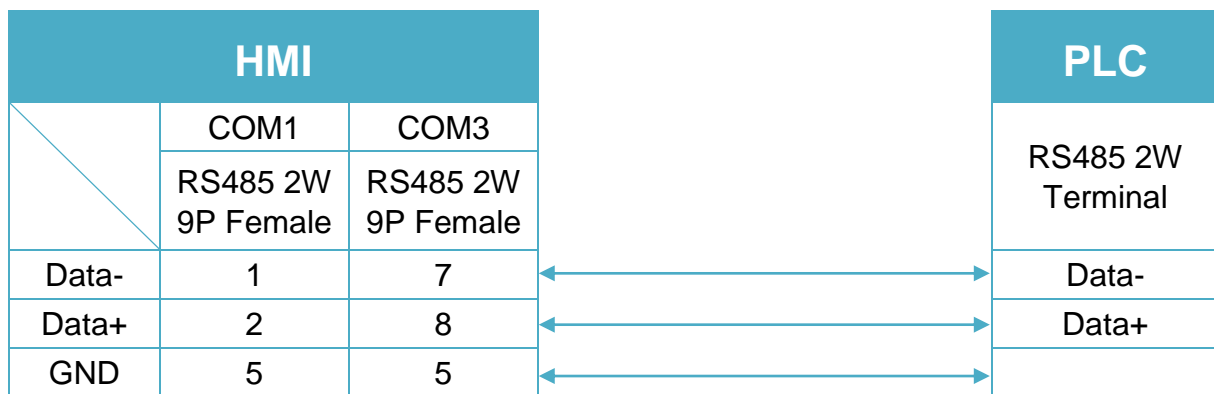
MT-iE *MT8071iE / MT6071iE / MT8072iE / MT6072iE / MT8073iE / MT8101iE / MT8102iE / MT8103iE*

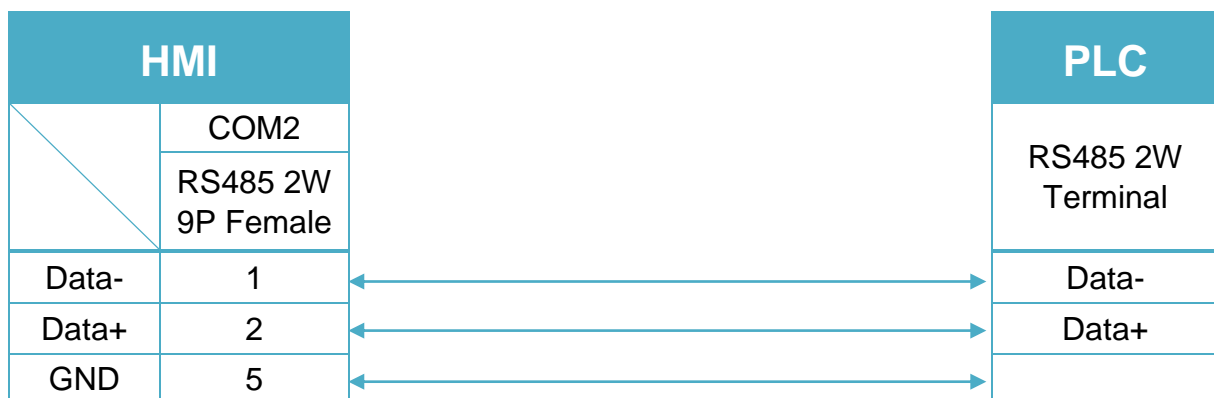
MT-XE *MT8090XE / MT8092XE*

MT-iP *MT6103iP*


Diagram 5

MT-iE *MT8050iE*

MT-iP *MT6051iP*

Diagram 6

MT-iP *MT6071iP / MT8071iP*


ELSIST MODBUS ASCII

Supported Series: SlimLine & Netsyst controllers RS232/485

Website: <http://www.elsist.it>

HMI Setting:

Parameters	Recommended	Options	Notes
PLC type	ELSIST MODBUS ASCII		
PLC I/F	RS485	RS232/RS485	
Baud rate	115200	9600~115200	
Data bits	8	7,8	
Parity	Even	Even, Odd, None	
Stop bits	1	1,2	
PLC sta. no.	1	0-254 (255 Broadcast)	

Online simulator	YES	Broadcast	YES
Extend address mode	YES		

PLC Setting:

Communication mode	Modbus ASCII protocol
--------------------	-----------------------

Device Address:

Bit/Word	Device type	Format	Range	Memo
B	%MX	DDDDD	1 ~ 65535	0x01 read coil 0x05 write single coil
B	%MW_Bit	DDDDDdd	100 ~ 6553515	0x03 read holding register 0x10 write single register
W	%MW	DDDDD	1 ~ 65535	0x03 read holding register 0x10 write multiple register
DW	%MDW	DDDDD	1 ~ 65535	0x03 read holding register 0x10 write multiple register

Wiring Diagram:

RS-232 8P RJ45 (Diagram 1 ~ Diagram 3)

Diagram 1

cMT Series	<i>cMT3151</i>
eMT Series	<i>eMT3070 / eMT3105 / eMT3120 / eMT3150</i>
MT-iE	<i>MT8073iE / MT8102iE</i>
MT-XE	<i>MT8092XE</i>
MT-iP	<i>MT6103iP</i>

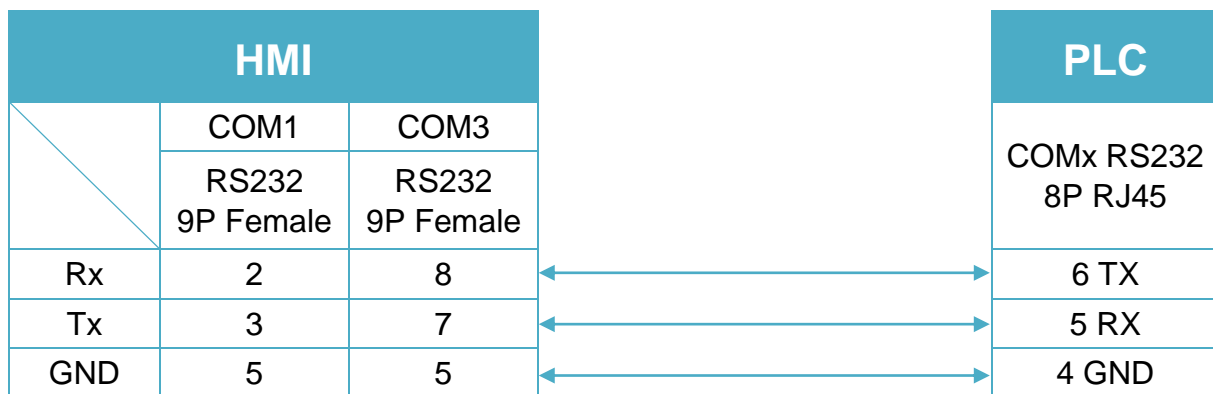


Diagram 2

cMT Series	cMT-SVR
mTV	mTV
MT-iE	MT8070iE / MT6070iE / MT8100iE / MT8121iE / MT8150iE / MT8071iE / MT6071iE / MT8072iE / MT6072iE / MT8073iE / MT8101iE / MT8102iE / MT8103iE
MT-XE	MT8121XE / MT8150XE / MT8090XE

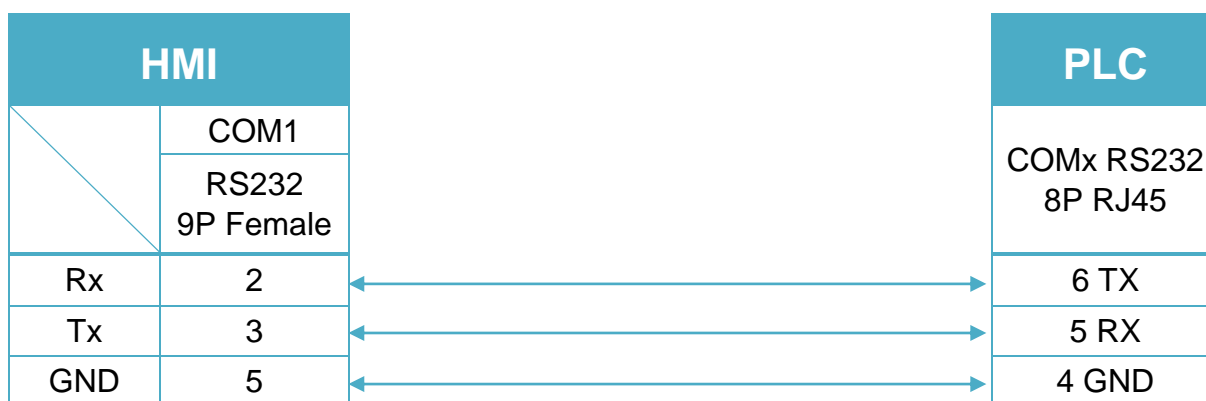
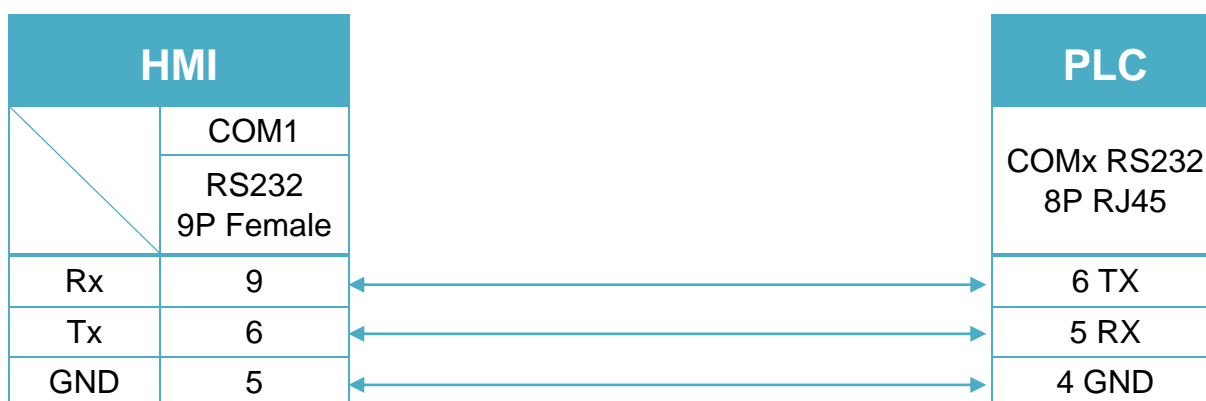


Diagram 3

MT-iE	MT8050iE
MT-iP	MT6051iP / MT6071iP / MT8071iP





RS-485 2W 3-Way TB (Diagram 4 ~ Diagram 9)

Diagram 4

cMT Series	<i>cMT3151</i>
eMT Series	<i>eMT3070 / eMT3105 / eMT3120 / eMT3150</i>

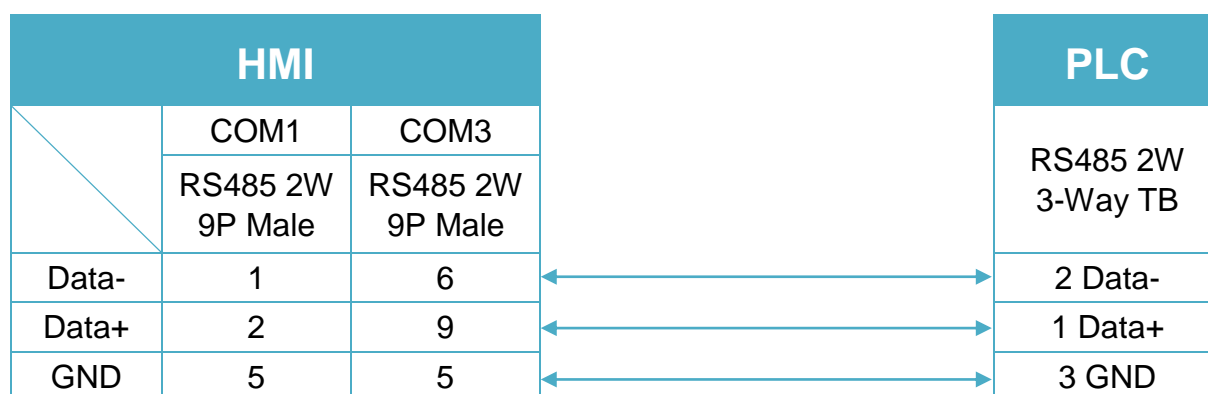


Diagram 5

cMT Series	<i>cMT-SVR</i>
mTV	<i>mTV</i>

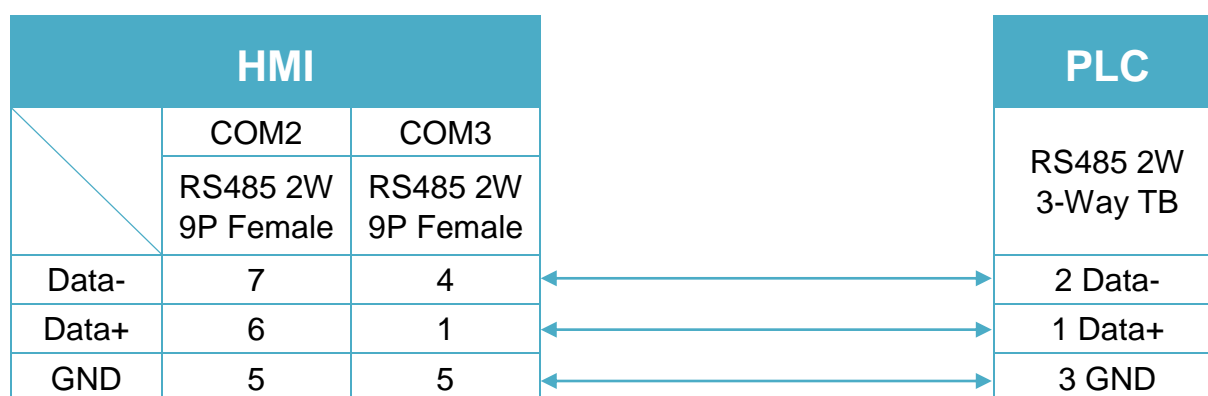


Diagram 6

MT-iE *MT8070iE / MT6070iE / MT8100iE / MT8121iE / MT8150iE*

MT-XE *MT8121XE / MT8150XE*

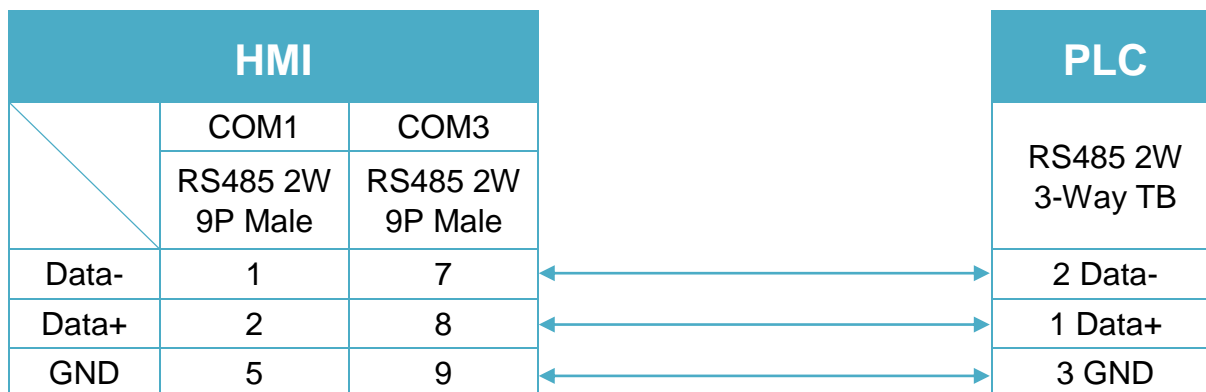


Diagram 7

MT-iE *MT8071iE / MT6071iE / MT8072iE / MT6072iE / MT8073iE /
MT8101iE / MT8102iE / MT8103iE*

MT-XE *MT8090XE / MT8092XE*

MT-iP *MT6103iP*

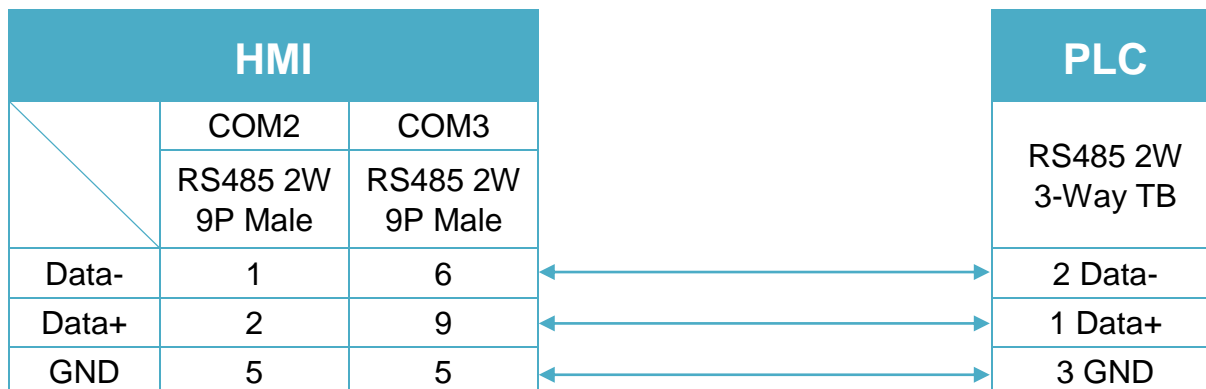
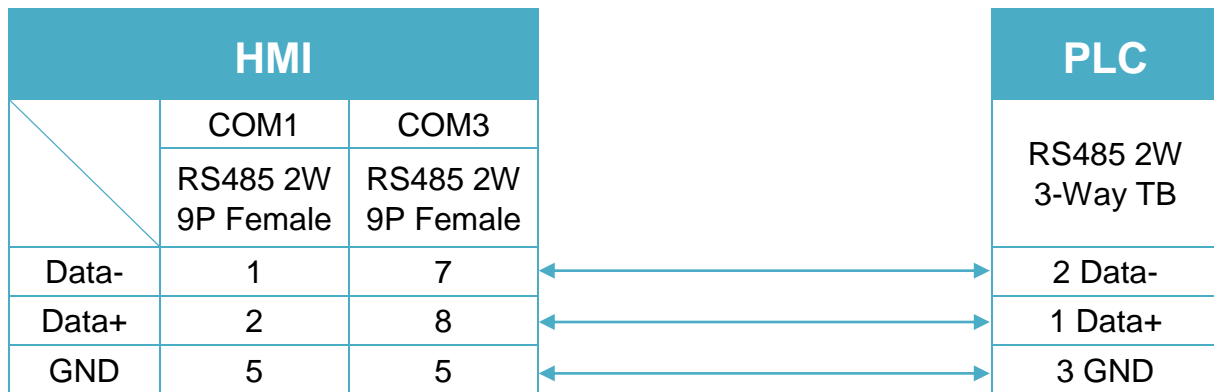
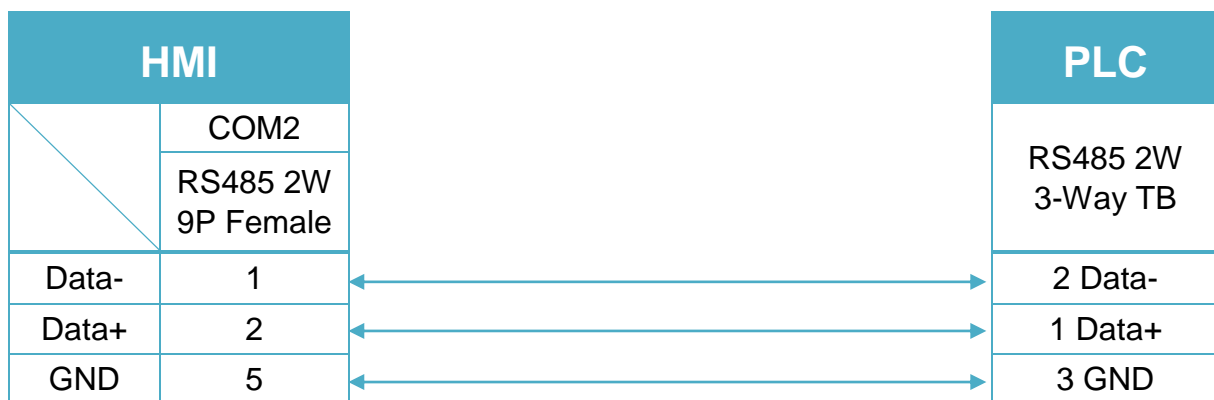


Diagram 8
MT-iE *MT8050iE*
MT-iP *MT6051iP*

Diagram 9
MT-iP *MT6071iP / MT8071iP*


ELSIST MODBUS RTU

Supported Series : SlimLine & Netsyst controllers RS232/485

Website : <http://www.elsist.it>

HMI Setting:

Parameters	Recommended	Options	Notes
PLC type	ELSIST MODBUS ASCII		
PLC I/F	RS485	RS232/RS485	
Baud rate	115200	9600~115200	
Data bits	8	7, 8	
Parity	Even	Even, Odd, None	
Stop bits	1	1, 2	
PLC sta. no.	1	0 – 254 (255 Broadcast)	

Online simulator	YES	Broadcast	YES
Extend address mode	YES		

PLC Setting:

Communication mode	Modbus RTU protocol
--------------------	---------------------

Device Address:

Bit/Word	Device type	Format	Range	Memo
B	%MX	DDDDD	1 ~ 65535	0x01 Read coil 0x05 write single coil
B	%MX_Bit	DDDDDdd	100 ~ 6553515	0x03 Read holding register 0x10 write single register
W	%MW	DDDDD	1 ~ 65535	0x03 Read holding register 0x10 write multiple registers
DW	%MWD	DDDDD	1 ~ 65535	0x03 Read holding register 0x10 write multiple registers

Wiring Diagram:

RS-232 8P RJ45 (Diagram 1 ~ Diagram 3)

Diagram 1

cMT Series	<i>cMT3151</i>
eMT Series	<i>eMT3070 / eMT3105 / eMT3120 / eMT3150</i>
MT-iE	<i>MT8073iE / MT8102iE</i>
MT-XE	<i>MT8092XE</i>
MT-iP	<i>MT6103iP</i>

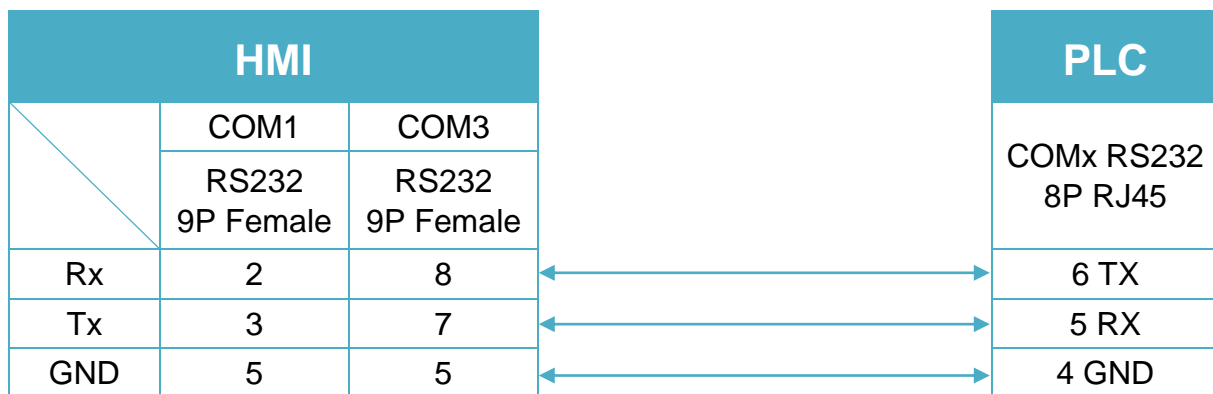


Diagram 2

cMT Series	cMT-SVR
mTV	mTV
MT-iE	MT8070iE / MT6070iE / MT8100iE / MT8121iE / MT8150iE / MT8071iE / MT6071iE / MT8072iE / MT6072iE / MT8073iE / MT8101iE / MT8102iE / MT8103iE
MT-XE	MT8121XE / MT8150XE / MT8090XE

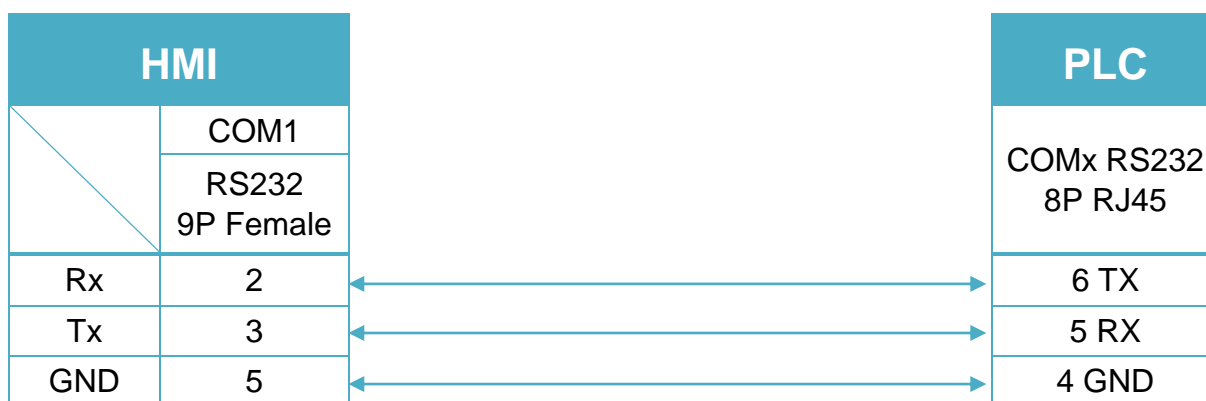
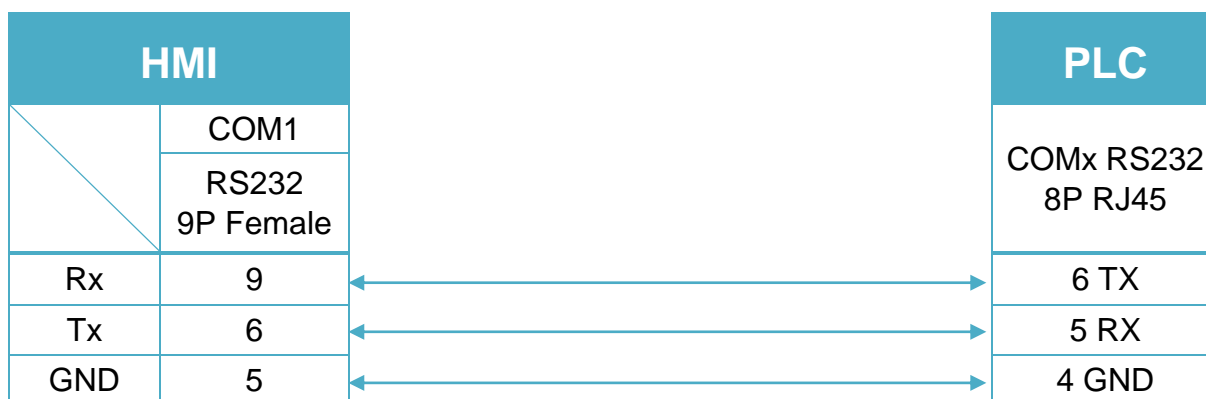


Diagram 3

MT-iE	MT8050iE
MT-iP	MT6051iP / MT6071iP / MT8071iP



RS-485 2W 3-Way TB (Diagram 4 ~ Diagram 9)



Diagram 4

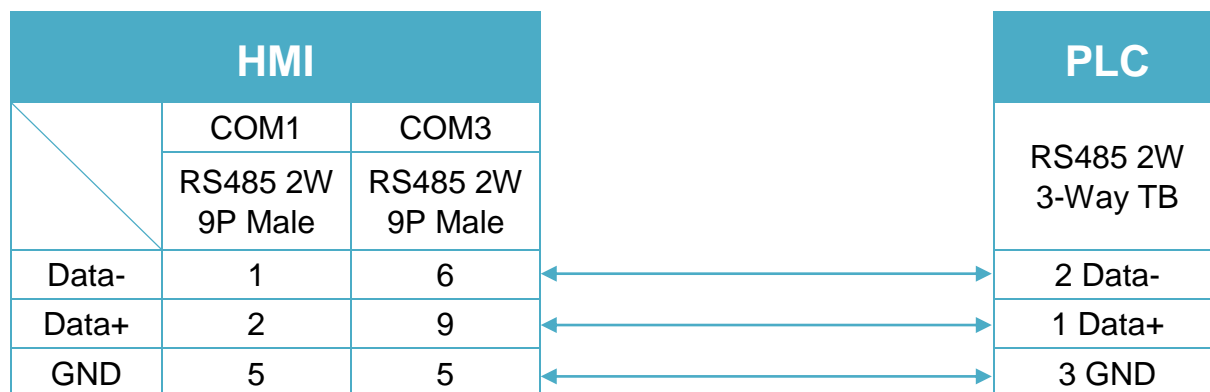
cMT Series *cMT3151*
eMT Series *eMT3070 / eMT3105 / eMT3120 / eMT3150*


Diagram 5

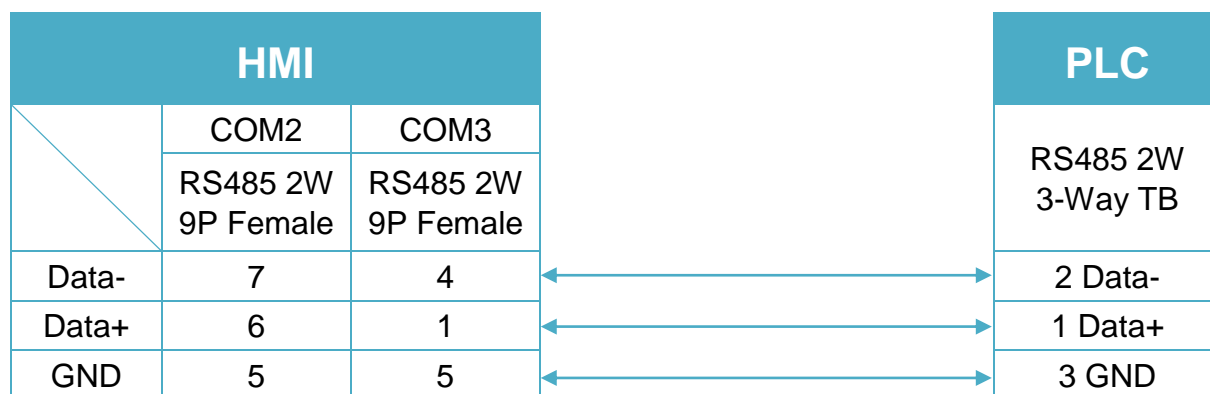
cMT Series *cMT-SVR*
mTV *mTV*


Diagram 6

MT-iE *MT8070iE / MT6070iE / MT8100iE / MT8121iE / MT8150iE*

MT-XE *MT8121XE / MT8150XE*

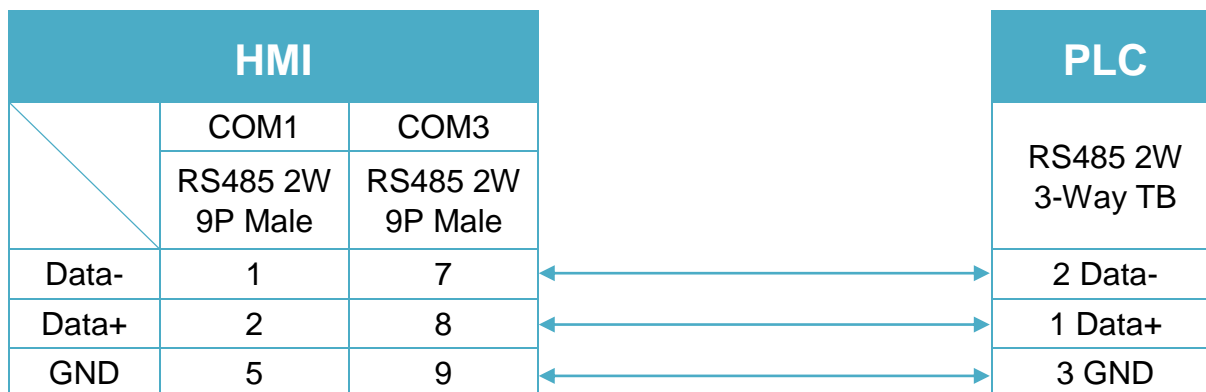


Diagram 7

MT-iE *MT8071iE / MT6071iE / MT8072iE / MT6072iE / MT8073iE /
MT8101iE / MT8102iE / MT8103iE*

MT-XE *MT8090XE / MT8092XE*

MT-iP *MT6103iP*

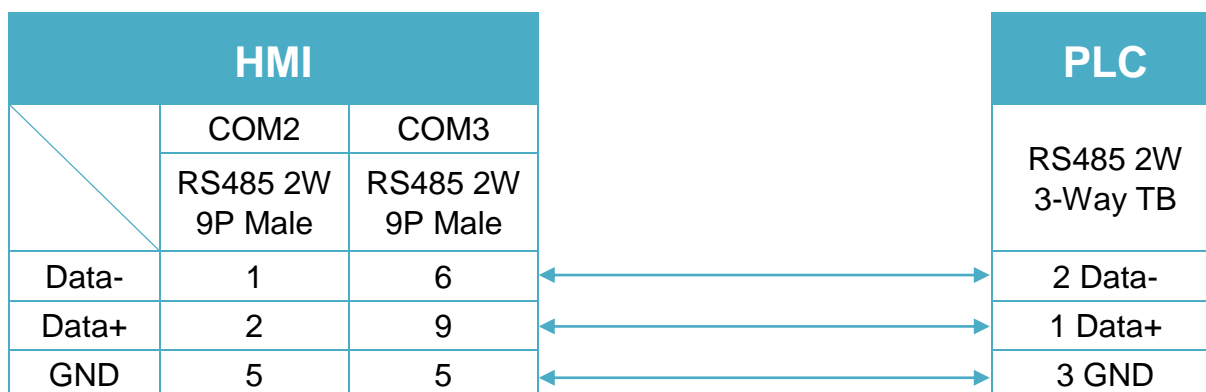
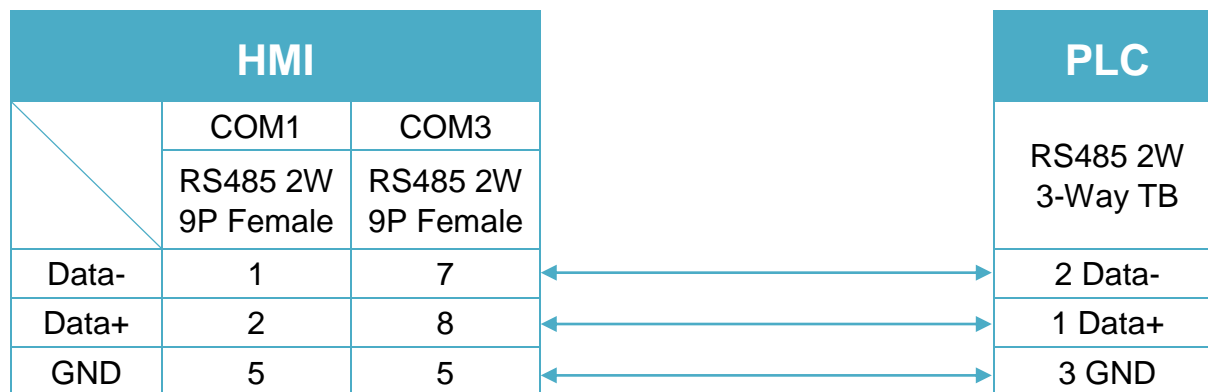
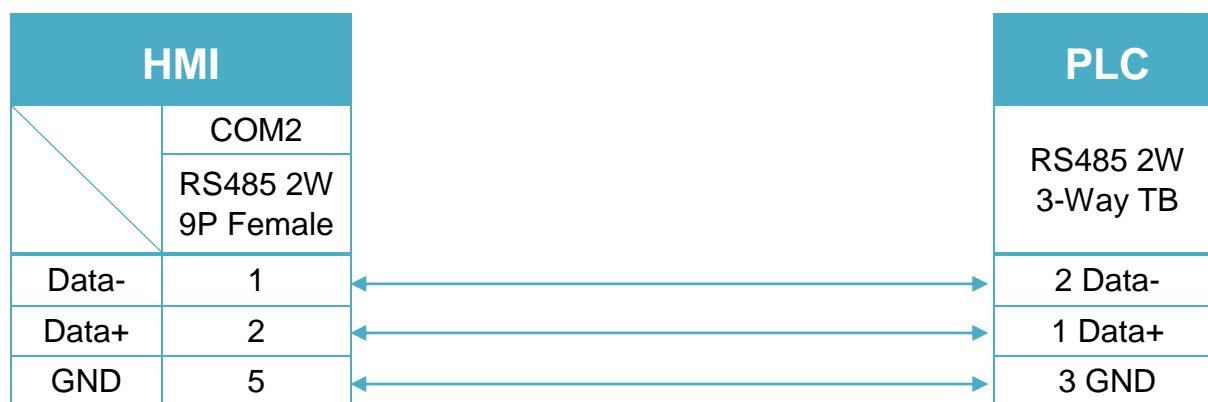


Diagram 8
MT-iE *MT8050iE*
MT-iP *MT6051iP*

Diagram 9
MT-iP *MT6071iP / MT8071iP*


ELSIST MODBUS TCP/IP

Supported Series: SlimLine & Netsyst controllers Ethernet TCP/IP

Website: <http://www.elsist.it>

HMI Setting:

Parameters	Recommended	Options	Notes
PLC type	ELSIST MODBUS TCP/IP		
PLC I/F	Ethernet		
Port no.	502		
PLC sta. no.	1	0~254 (255 Broadcast)	

PLC Setting:

Communication mode	Modbus TCP/IP
---------------------------	---------------

Device Address:

Bit/Word	Device type	Format	Range	Memo
B	%MX	DDDDD	1 ~ 65535	0x01 Read coil 0x05 write single coil
B	%MW_Bit	DDDDDdd	100 ~ 6553515	0x03 Read holding register 0x10 write single register
W	%MW	DDDDD	1 ~ 65535	0x03 Read holding register 0x10 write multiple registers
DW	%MWD	DDDDD	1 ~ 65535	0x03 Read holding register 0x10 write multiple registers

Wiring Diagram:

Ethernet cable:



EMERSON Charge Module

Website: <http://www.emersonnetworkpower.com.cn/Pages/Default.aspx>

HMI Setting:

Parameters	Recommended	Options	Notes
PLC type	EMERSON Charge Module		
PLC I/F	RS-232		
Baud rate	9600		
Data bits	8		
Parity	Odd		
Stop bits	1		
PLC sta. no.	1		

Device Address:

Bit/Word	Device type	Format	Range	Memo
B	Float_Point_Forced	D	0 ~ 1	
B	Average_Point_Forced	D	0 ~ 1	
W	Switch_Status	D	0 ~ 1	
W	Manual_Status	D	0 ~ 1	
W	Protect_Status	D	0 ~ 1	
W	Failure_Status	D	0 ~ 1	
W	Preset_Voltage	D	0 ~ 1	
W	Preset_Percent	D	0 ~ 1	
W	Output_Voltage	D	0 ~ 1	
W	Output_Current	D	0 ~ 1	
W	High_Limit	D	0 ~ 1	
W	Low_Limit	D	0 ~ 1	
W	Float_Point_Setting	D	0 ~ 1	
W	Average_Point_Setting	D	0 ~ 1	

Wiring Diagram:

RS-232 Terminal (Diagram 1 ~ Diagram 3)

Diagram 1

cMT Series	<i>cMT3151</i>
eMT Series	<i>eMT3070 / eMT3105 / eMT3120 / eMT3150</i>
MT-iE	<i>MT8073iE / MT8102iE</i>
MT-XE	<i>MT8092XE</i>
MT-iP	<i>MT6103iP</i>

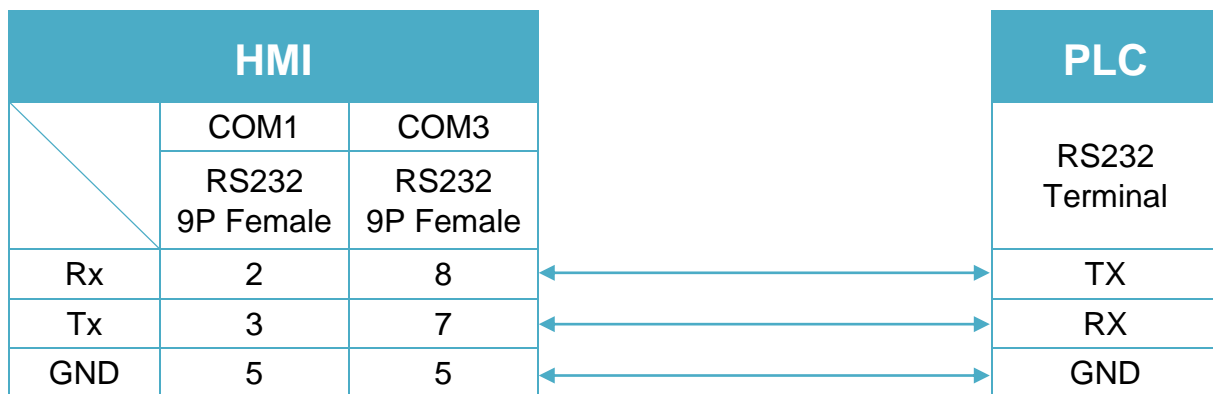


Diagram 2

cMT Series	cMT-SVR
mTV	mTV
MT-iE	MT8070iE / MT6070iE / MT8100iE / MT8121iE / MT8150iE / MT8071iE / MT6071iE / MT8072iE / MT6072iE / MT8073iE / MT8101iE / MT8102iE / MT8103iE
MT-XE	MT8121XE / MT8150XE / MT8090XE

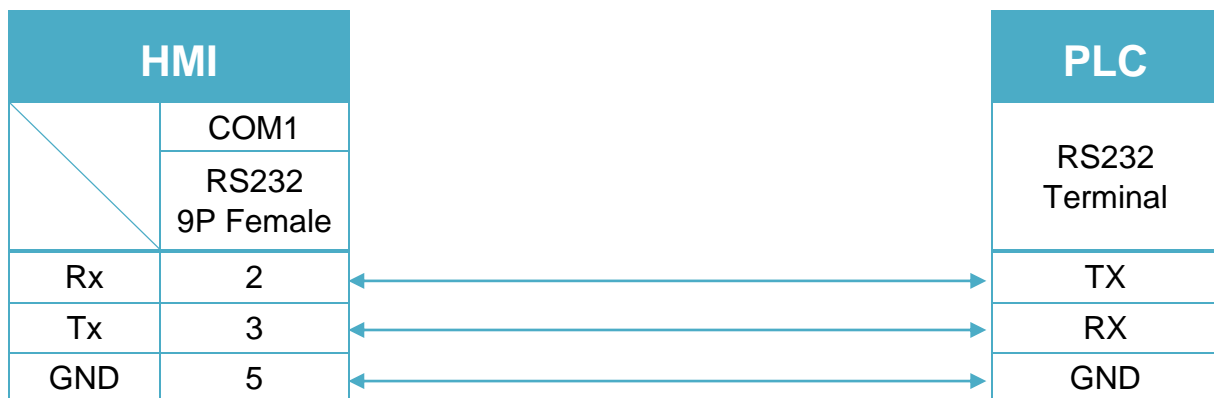
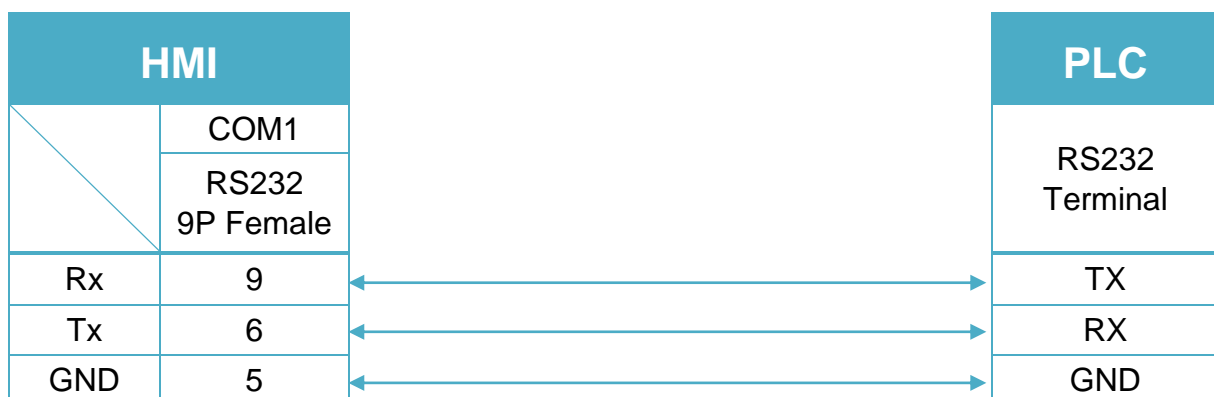


Diagram 3

MT-iE	MT8050iE
MT-iP	MT6051iP / MT6071iP / MT8071iP



EMERSON ControlWave (Ethernet) – Free Tag

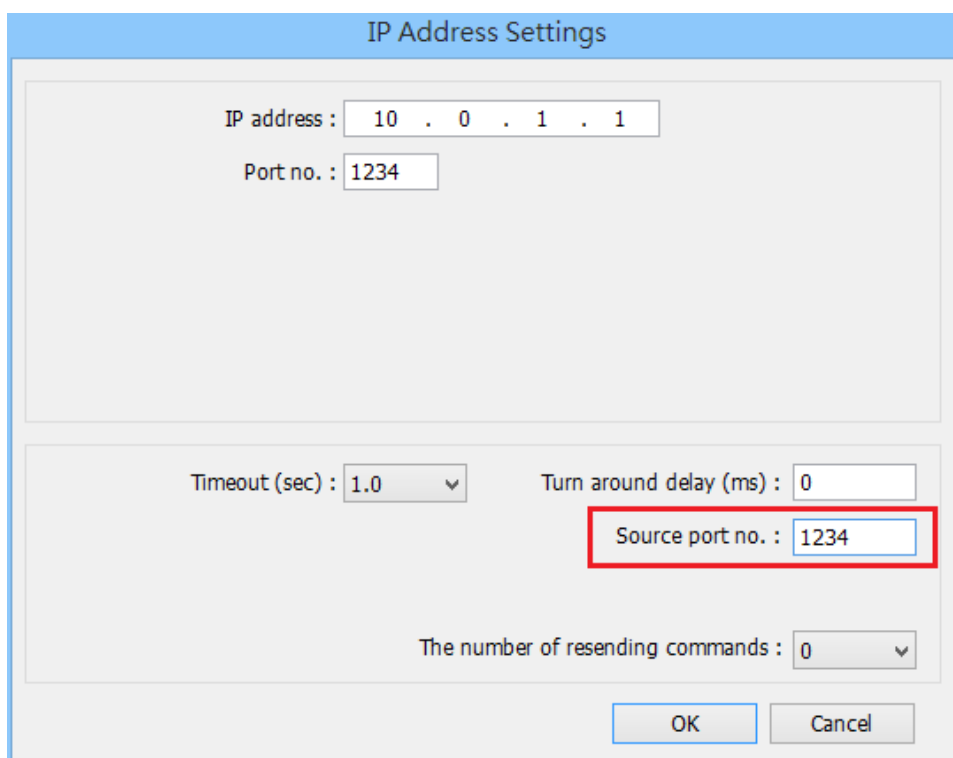
Names

Supported Series: EMERSON ControlWave MICRO

Website: <http://www2.emersonprocess.com/en-US/Pages/Home.aspx>

HMI Setting:

Parameters	Recommended	Options	Notes
PLC type	EMERSON ControlWave (Ethernet) – Free Tag Names		Use UDP
PLC I/F	Ethernet		
Port no.	1234		
Source port no.	1234		



IP Address Settings

IP address : 10 . 0 . 1 . 1

Port no. : 1234

Timeout (sec) : 1.0

Turn around delay (ms) : 0

Source port no. : 1234

The number of resending commands : 0

OK Cancel

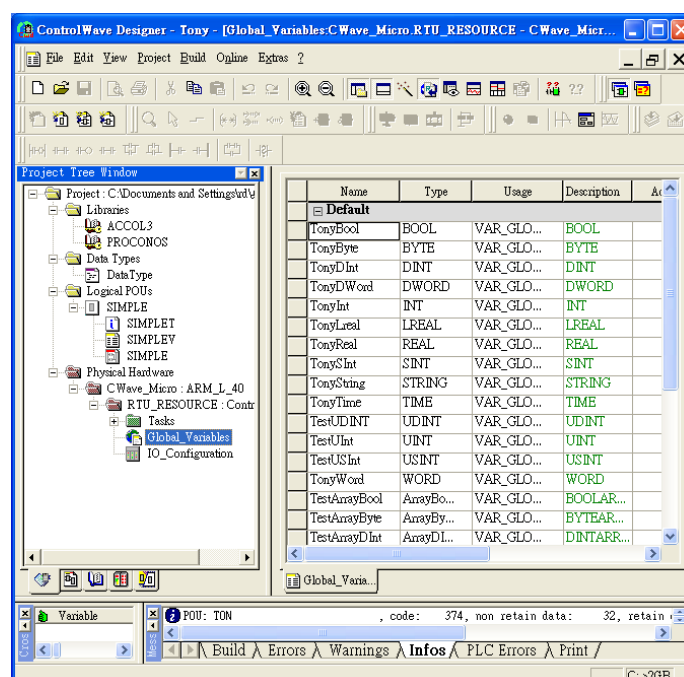
Support Device Type:

Data type	EasyBuilder data format	Memo
Bool	bit	
Byte	16-bit BCD, Hex, Binary, Unsigned	8-bit
SInt	16-bit BCD, Hex, Binary, Signed	8-bit
USInt	16-bit BCD, Hex, Binary, Unsigned	8-bit
Word	16-bit BCD, Hex, Binary, Unsigned	16-bit
Int	16-bit BCD, Hex, Binary, Signed	16-bit
UInt	16-bit BCD, Hex, Binary, Unsigned	16-bit
DWord	32-bit BCD, Hex, Binary, Unsigned	32-bit
DInt	32-bit BCD, Hex, Binary, Signed	32-bit
Real	32-bit Float	32-bit
UDInt	32-bit BCD, Hex, Binary, Unsigned	32-bit

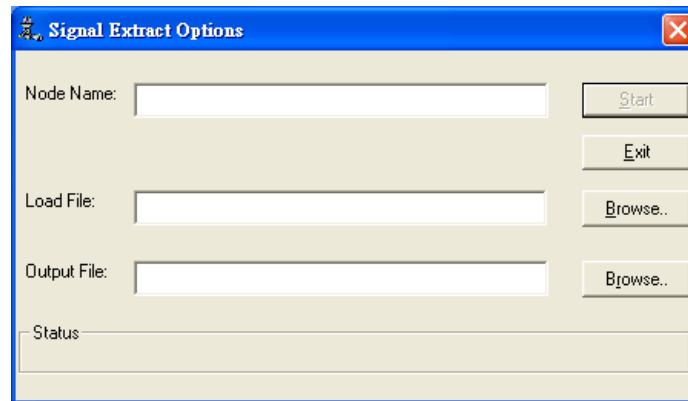
* For device types: **DWord / DINT / UDINT / Real** , error may occur if the value exceeds 7 digits (million).

PLC Setting:

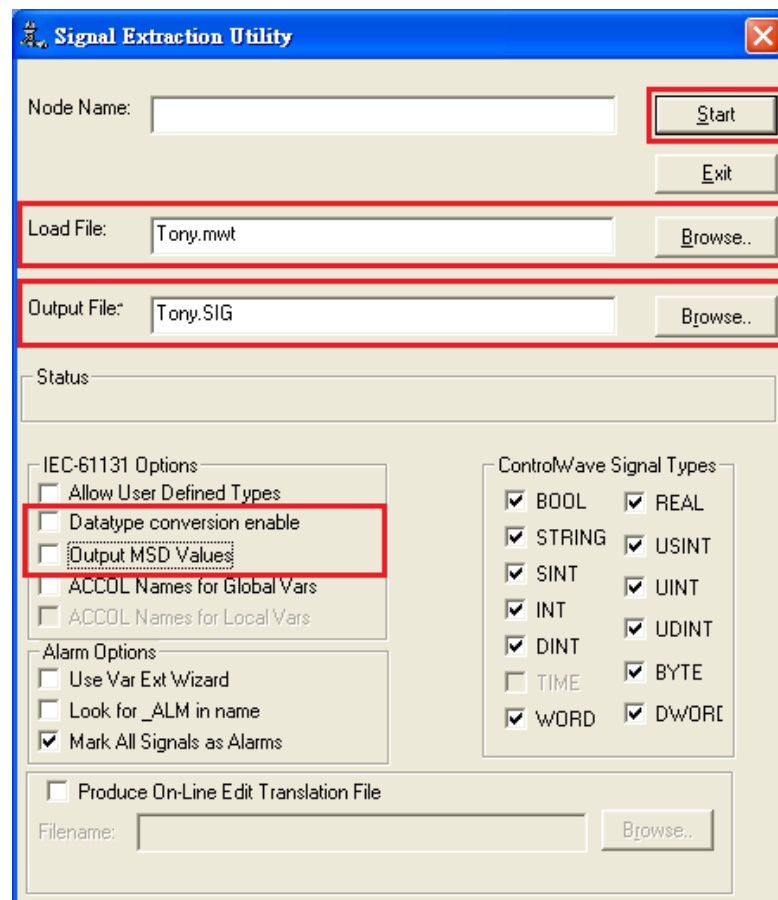
1. Under **Global Variables** create the tags, a tag name with over 20 words can affect communication, please avoid it.



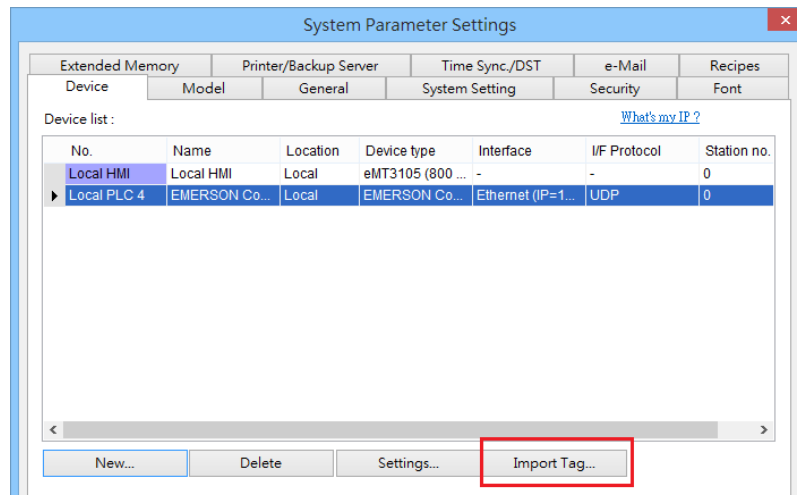
- Open the program from **Programs -> OpenBSI Tool -> Common Tools -> Signal Extractor**.



- Browse for the file name in **Load File** field, and then the **Output File** field will automatically generate the SIG file name. In **IEC-61131 Options** group box, deselect **Datatype conversion enable** and **Output MSD Values** check boxes, and then click **Start** to generate the file for tag import.



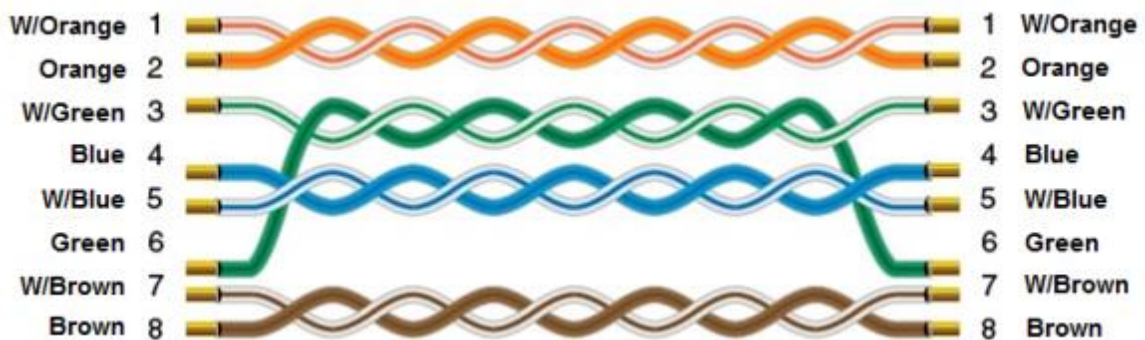
4. Import the tags after adding the driver in EasyBuilder.



Wiring Diagram:

Diagram 1

Ethernet cable:



EMERSON PLC EC20

Supported Series: EMERSON PLC EC20 Series. (Modbus RTU Protocol)

HMI Setting:

Parameters	Recommended	Options	Notes
PLC type	EMERSON PLC EC20		
PLC I/F	RS232		
Baud rate	9600	9600, 19200, 115200	
Data bits	8	7 or 8	
Parity	Even	Even, Odd, None	
Stop bits	1	1 or 2	
PLC sta. no.	0	0-255	

PLC Setting:

Communication mode	Modbus RTU protocol
---------------------------	---------------------

Device Address:

Bit/Word	Device type	Format	Range	Memo
B	Y	OOO	0 ~ 377	0000-02550
B	X	OOO	0 ~ 377	1200-01455 0000-0255
B	M	DDDD	0 ~ 1999	2000-3999
B	SM	DDD	0~ 255	4400-4655
B	S	DDD	0 ~ 991	6000-6991
B	T	DDD	0 ~ 255	8000-8255
B	C	DDD	0 ~ 255	9200-9455
W	D	DDDD	0 ~ 7999	0000-7999
DW	D_Double	DDDD	0 ~ 7998	
W	SD	DDD	0 ~ 255	8000-8255
W	Z	DD	0 ~ 15	8500-8515
W	TV	DDD	0 ~ 255	9000-9255
W	CV	DDD	0 ~ 199	9500-9699
DW	C_Double	DDD	200 ~ 255	9700-9811

Wiring Diagram:

Emerson EC 20 COM1: RS-232 Terminal (Diagram 1 ~ Diagram 3)

Diagram 1

cMT Series	<i>cMT3151</i>
eMT Series	<i>eMT3070 / eMT3105 / eMT3120 / eMT3150</i>
MT-iE	<i>MT8073iE / MT8102iE</i>
MT-XE	<i>MT8092XE</i>
MT-iP	<i>MT6103iP</i>

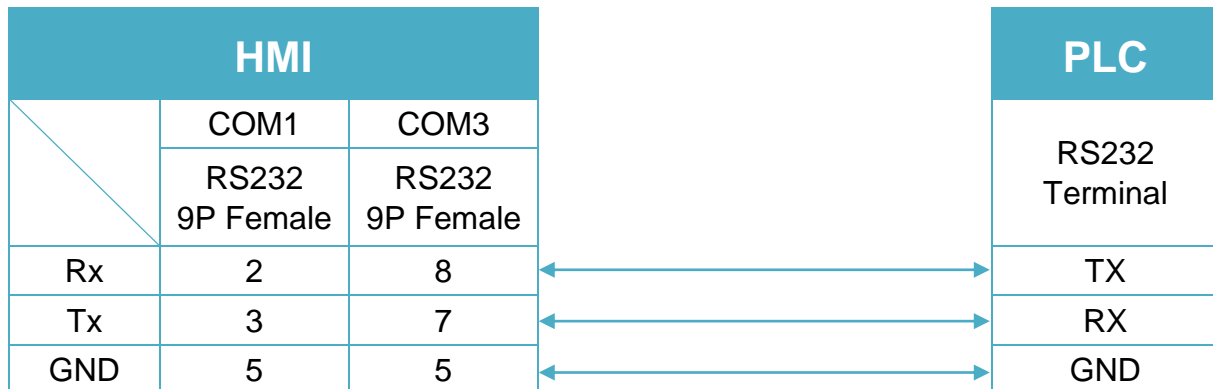


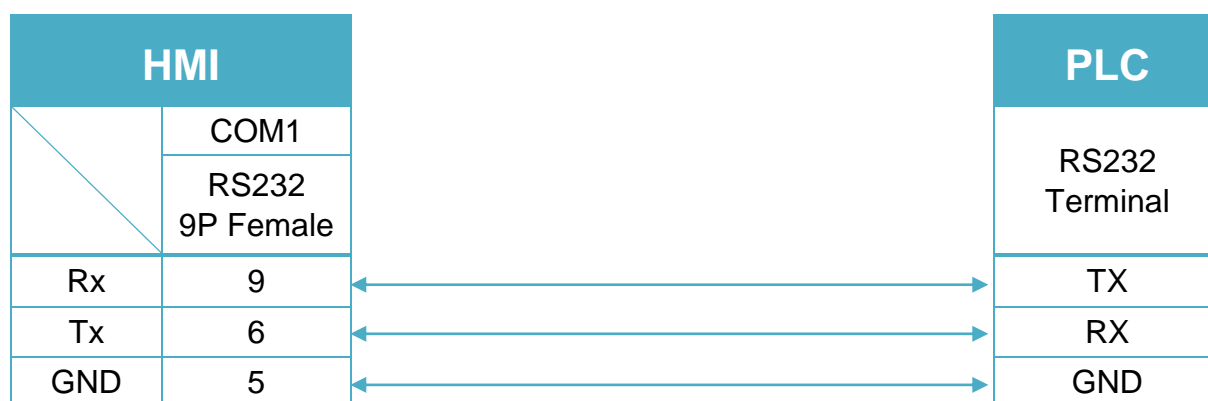
Diagram 2

cMT Series	cMT-SVR
mTV	mTV
MT-iE	MT8070iE / MT6070iE / MT8100iE / MT8121iE / MT8150iE / MT8071iE / MT6071iE / MT8072iE / MT6072iE / MT8073iE / MT8101iE / MT8102iE / MT8103iE
MT-XE	MT8121XE / MT8150XE / MT8090XE



Diagram 3

MT-iE	MT8050iE
MT-iP	MT6051iP / MT6071iP / MT8071iP



EMERSON ROC800 Series - Free Tag Names

Supported Series: EMERSON ROC800 Series

Website: <http://www2.emersonprocess.com/en-US/Pages/Home.aspx>

HMI Setting(Ethernet):

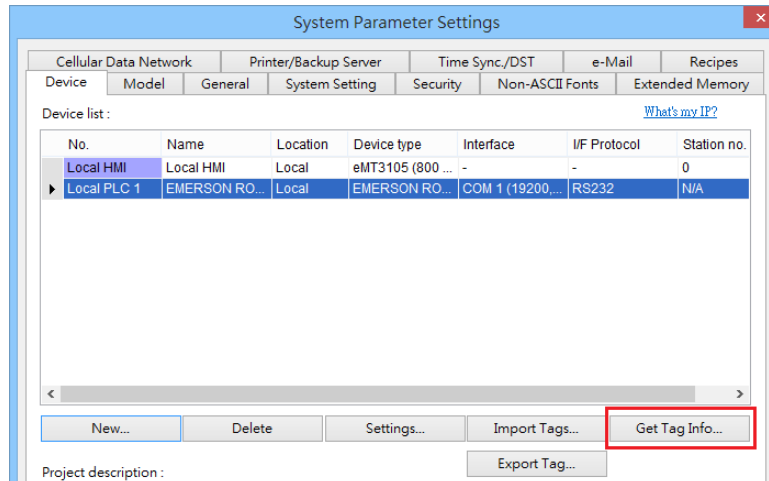
Parameters	Recommended	Options	Notes
PLC type	EMERSON ROC800 Series - Free Tag Names		
PLC I/F	Ethernet		
Port no.	4000		
Device address	240		
Device group	240		
No.of all alarms	1		
Host group	1		

HMI Setting(RS-232):

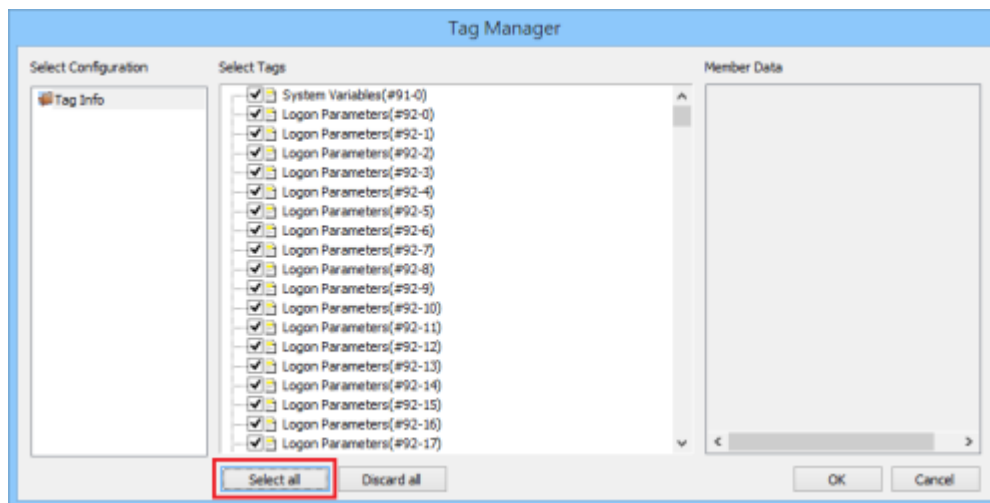
Parameters	Recommended	Options	Notes
PLC type	EMERSON ROC800 Series - Free Tag Names		
PLC I/F	RS232		
Baud rate	19200		
Data bits	8	7, 8	
Parity	None	None, Odd, Even	
Stop bits	1	1, 2	
Device address	240		
Device group	240		
No.of all alarms	1		
Host group	1		

How to Import Tags:

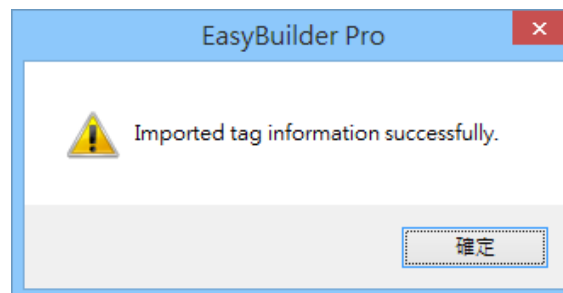
Step 1: Click **[Get Tag Info]**



Step 2: **[Select all]** -> **[OK]**



Step 3: Imported tag information successfully.



Support Device Type:

Data Type	EasyBuilder data format	Memo
Bool	bit	
Word	16-bit BCD, Hex, Binary, Unsigned	16-bit
DWord	32-bit BCD, Hex, Binary, Unsigned	32-bit
Real	32-bit Float	32-bit
String	ASCII input and ASCII display	The length of the setting must be correct

Wiring Diagram:

RS-232 Terminal (Diagram 1 ~ Diagram 3)

Diagram 1

cMT Series	<i>cMT3151</i>
eMT Series	<i>eMT3070 / eMT3105 / eMT3120 / eMT3150</i>
MT-iE	<i>MT8073iE / MT8102iE</i>
MT-XE	<i>MT8092XE</i>
MT-iP	<i>MT6103iP</i>

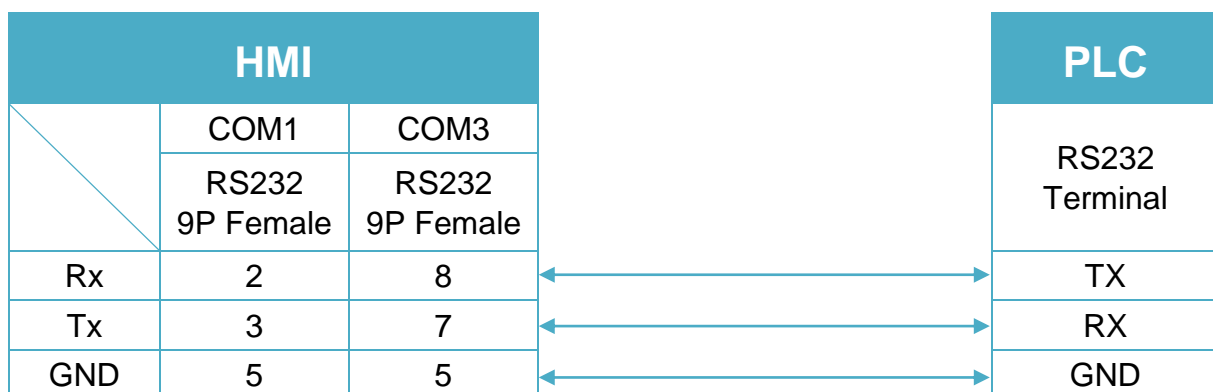


Diagram 2

cMT Series	cMT-SVR
mTV	mTV
MT-iE	MT8070iE / MT6070iE / MT8100iE / MT8121iE / MT8150iE / MT8071iE / MT6071iE / MT8072iE / MT6072iE / MT8073iE / MT8101iE / MT8102iE / MT8103iE
MT-XE	MT8121XE / MT8150XE / MT8090XE

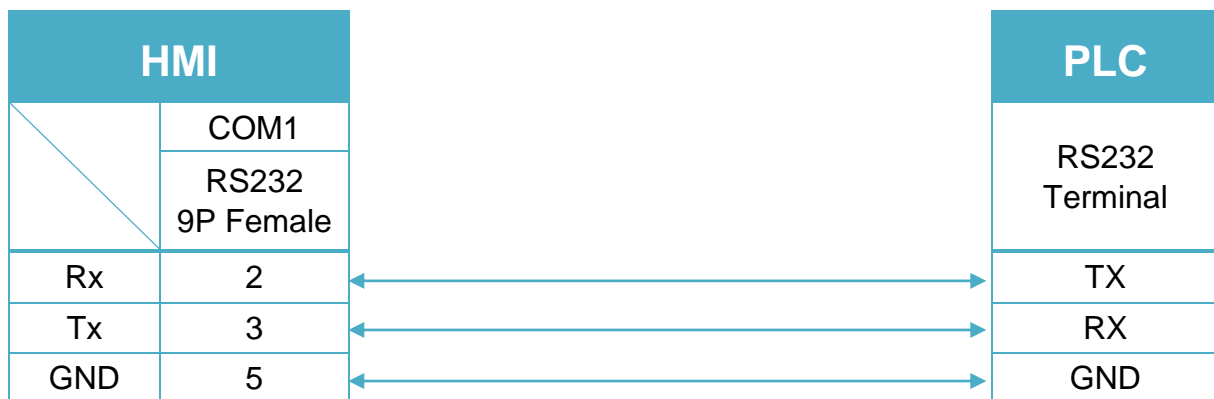


Diagram 3

MT-iE	MT8050iE
MT-iP	MT6051iP / MT6071iP / MT8071iP

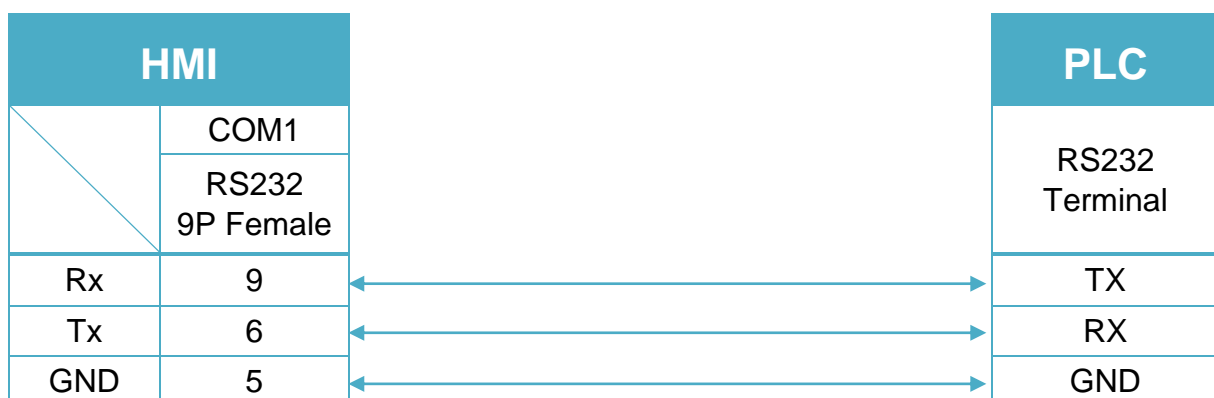


Diagram 4

Ethernet cable:



Emotiontek MCU Controller

Supported Series: Emotiontek MCU-XP/XP2 Controller

Website: <http://emotiontek.com/sub/index.php>

HMI Setting:

Parameters	Recommended	Options	Notes
PLC type	Emotiontek MCU Controller		
PLC I/F	RS232	RS232/RS485 2W	
Baud rate	38400	9600 ~ 115200	
Data bits	8	7,8	
Parity	None	None,Odd,Even	
Stop bits	1	1,2	
PLC sta. no.	0	0-255	

PLC Setting:

Protocol type	1,4
----------------------	-----

Device Address:

Bit/Word	Device type	Format	Range	Memo
B	X_Bit	Hh	0 ~ 5f	
B	Y_Bit	Hh	0 ~ 4f	
B	F_Bit	Dh	0 ~ 9f	
B	M_Bit	DDDh	0 ~ 199f	
B	T_Bit	Dh	0 ~ 0f	
B	C_Bit	Dh	0 ~ 0f	
W	X	D	0 ~ 5	
W	Y	D	0 ~ 4	
W	F	D	0 ~ 9	
W	M	DDD	0 ~ 199	
W	T	D	0	
W	C	D	0	
W	TP	DD	0 ~ 15	
W	TC	DD	0 ~ 15	
W	CP	DD	0 ~ 15	
W	CC	DD	0 ~ 15	

Bit/Word	Device type	Format	Range	Memo
DW	PD_X	DD	0 ~ 99	
DW	PD_Y	DD	0 ~ 99	
DW	FD	D	0 ~ 9	
DW	DD	D	0 ~ 9	
DW	LD	DDDD	0 ~ 1999	

Wiring Diagram:

RS-232 9P D-Sub (Diagram 1 ~ Diagram 3)

Diagram 1

cMT Series	<i>cMT3151</i>
eMT Series	<i>eMT3070 / eMT3105 / eMT3120 / eMT3150</i>
MT-iE	<i>MT8073iE / MT8102iE</i>
MT-XE	<i>MT8092XE</i>
MT-iP	<i>MT6103iP</i>

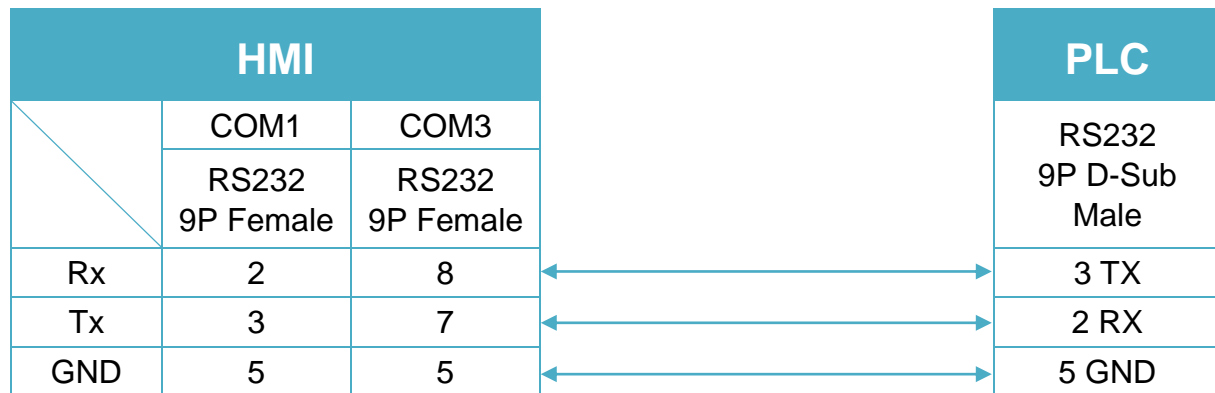


Diagram 2

cMT Series	<i>cMT-SVR</i>
mTV	<i>mTV</i>
MT-iE	<i>MT8070iE / MT6070iE / MT8100iE / MT8121iE / MT8150iE / MT8071iE / MT6071iE / MT8072iE / MT6072iE / MT8073iE / MT8101iE / MT8102iE / MT8103iE</i>
MT-XE	<i>MT8121XE / MT8150XE / MT8090XE</i>


Diagram 3
MT-iE *MT8050iE*
MT-iP *MT6051iP / MT6071iP / MT8071iP*


RS-485 2W 9P D-Sub (Diagram 4 ~ Diagram 9)

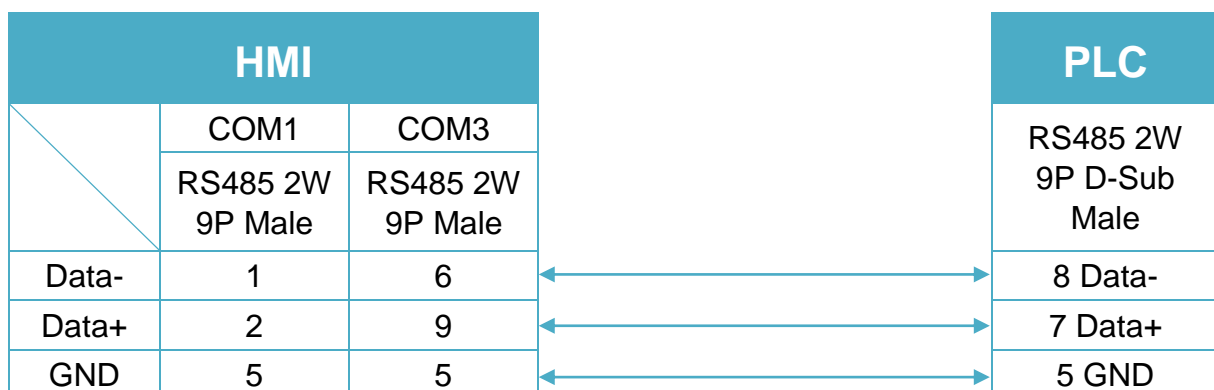
Diagram 4
cMT Series *cMT3151*
eMT Series *eMT3070 / eMT3105 / eMT3120 / eMT3150*


Diagram 5

cMT Series *cMT-SVR*

mTV *mTV*

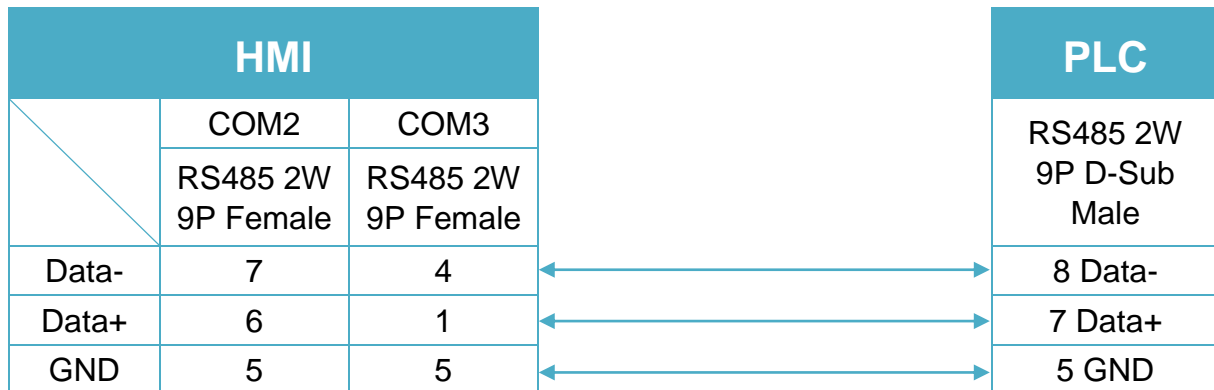


Diagram 6

MT-iE *MT8070iE / MT6070iE / MT8100iE / MT8121iE / MT8150iE*

MT-XE *MT8121XE / MT8150XE*

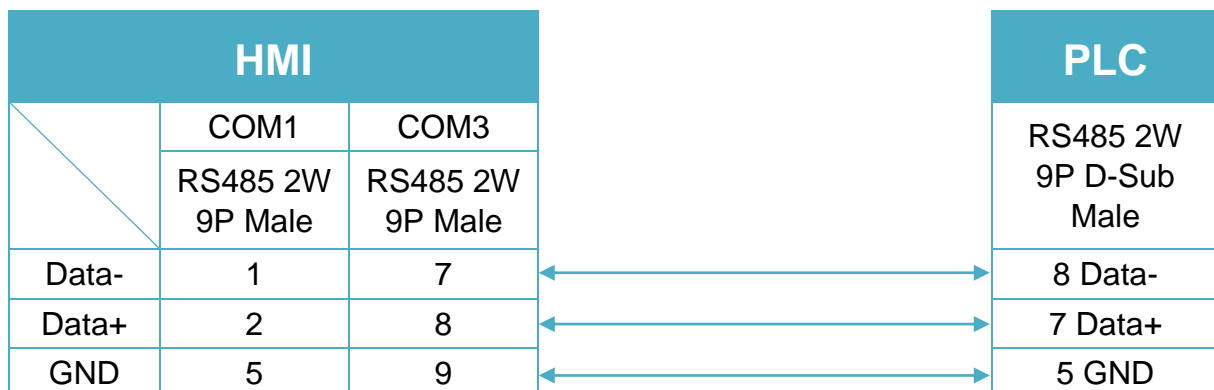


Diagram 7

MT-iE *MT8071iE / MT6071iE / MT8072iE / MT6072iE / MT8073iE /
MT8101iE / MT8102iE / MT8103iE*

MT-XE *MT8090XE / MT8092XE*

MT-iP *MT6103iP*

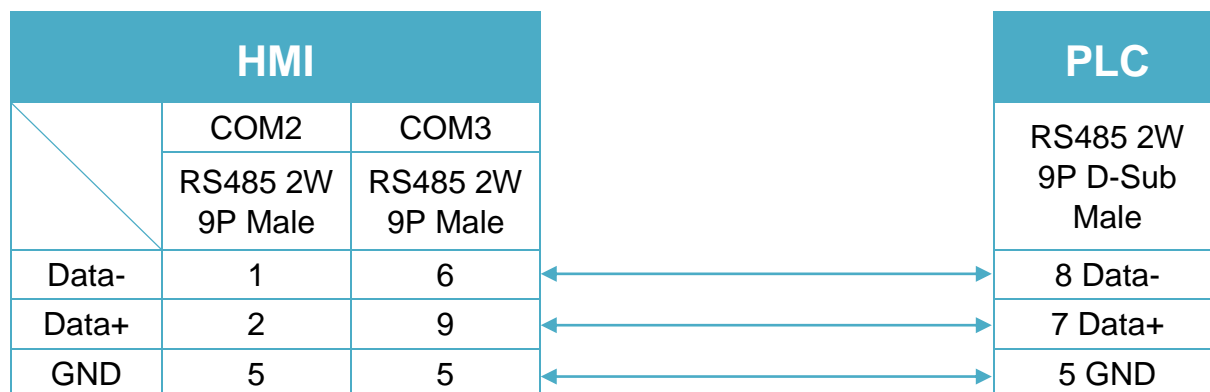


Diagram 8

MT-iE *MT8050iE*

MT-iP *MT6051iP*

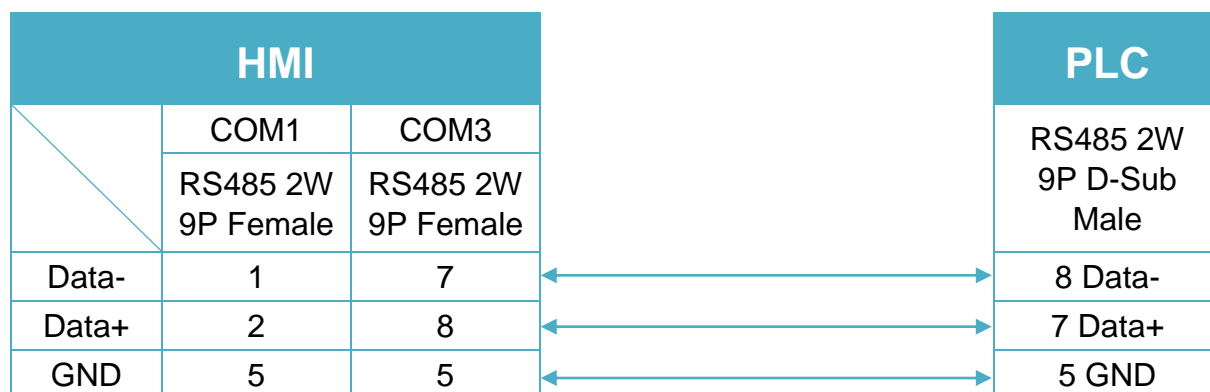
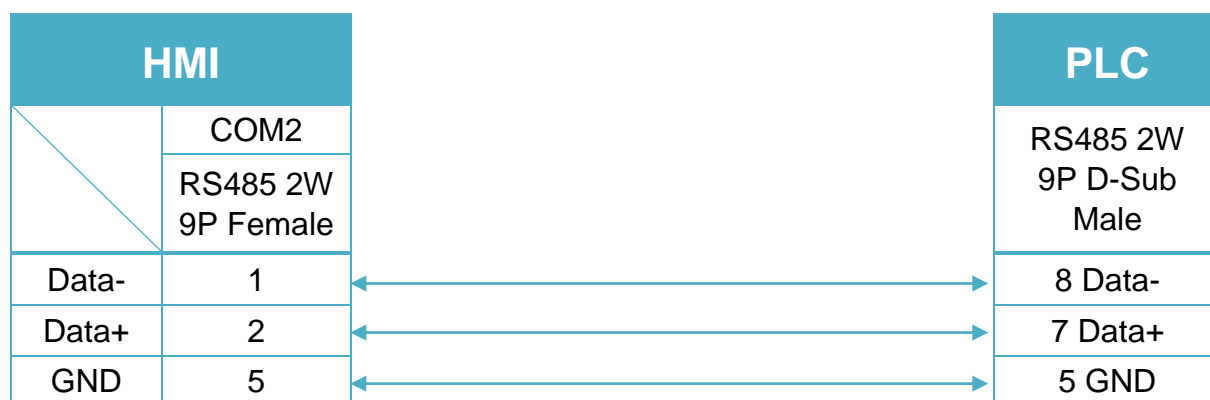


Diagram 9

MT-iP *MT6071iP / MT8071iP*



Epson Robot Controller

Supported Series: Epson Robot Controller

Website: <https://global.epson.com/>

HMI Setting(Ethernet):

Parameters	Recommended	Options	Notes
PLC type	Epson Robot Controller		
PLC I/F	Ethernet		
Port no.	5000		
Terminator	CRLF	CRLF / CR / LF	

Device Address:

Bit/Word	Device type	Format	Range	Memo
B	LOGIN	D	0	
B	LOGOUT	D	0	
B	STOP	D	0	
B	PAUSE	D	0	
B	CONTINUE	D	0	
B	RESET	D	0	
B	MOTOR	DD	1 ~ 16	Motor on / off No.1 ~ 16 Robot
B	IN_BIT	DDDDD	0 ~ 65535	
B	OUT_BIT	DDDDD	0 ~ 65535	
B	MEMIO_BIT	DDDDD	0 ~ 65535	
B	STATUS_TEST	D	0	
B	STATUS_TEACH	D	0	
B	STATUS_AUTO	D	0	
B	STATUS_WARNING	D	0	
B	STATUS_SERROR	D	0	
B	STATUS_SAFEGUARD	D	0	
B	STATUS_ESTOP	D	0	
B	STATUS_ERROR	D	0	
B	STATUS_PAUSE	D	0	
B	STATUS_RUNNING	D	0	
B	STATUS_READY	D	0	

Bit/Word	Device type	Format	Range	Memo
B	ABORT	D	0	
B	STAT_BIT	DDD	0 ~ 331	*Note2
B	RBTINF_BIT	DDD	0 ~ 531	*Note3
B	POWER	D	0	On: High / Off: Low
B	CTRLINF_BIT	DDDD	0 ~ 1031	*Note4
B	ATCLR	D	1 ~ 9	Clear and initializes the average torque
B	PTCLR	D	1 ~ 9	Clear and initializes the peak torque
B	IO_MAP_BIT	D	0	*Note9
B	CONSOLE	D	0	*Note11
B	+X_TOOL	D	0	
B	-X_TOOL	D	0	
B	+Y_TOOL	D	0	
B	-Y_TOOL	D	0	
B	+Z_TOOL	D	0	
B	-Z_TOOL	D	0	
B	+U_TOOL	D	0	
B	-U_TOOL	D	0	
B	+V_TOOL	D	0	
B	-V_TOOL	D	0	
B	+W_TOOL	D	0	
B	-W_TOOL	D	0	
B	+X_WORLD	D	0	
B	-X_WORLD	D	0	
B	+Y_WORLD	D	0	
B	-Y_WORLD	D	0	
B	+Z_WORLD	D	0	
B	-Z_WORLD	D	0	
B	+U_WORLD	D	0	
B	-U_WORLD	D	0	
B	+V_WORLD	D	0	
B	-V_WORLD	D	0	
B	+W_WORLD	D	0	
B	-W_WORLD	D	0	
B	+J1	D	0	
B	-J1	D	0	

Bit/Word	Device type	Format	Range	Memo
B	+J2	D	0	
B	-J2	D	0	
B	+J3	D	0	
B	-J3	D	0	
B	+J4	D	0	
B	-J4	D	0	
B	+J5	D	0	
B	-J5	D	0	
B	+J6	D	0	
B	-J6	D	0	
B	HAND_POS	D	0	
B	ELBOW	D	0	
B	WRIST	D	0	
W	LOGINPASS	D	0 ~ 8	*Note1
W	START	D	0	
W	CURROBOT	D	0	Read: Display Robot
W	HOME	D	0	Target Robot
W	IN_WORD	DDDD	0 ~ 4095	
W	OUT_WORD	DDDD	0 ~ 4095	
W	MEMIO_WORD	DDDD	0 ~ 4095	
W	STATUS_ERROR_CODE	D	0	
DW	STAT	D	0 ~ 3	*Note2
DW	RBTINF	D	0 ~ 5	*Note3
W	IO_LABEL	DDDDDDDDDD	0 ~ 226553599	*Note4
W	SYSERR	D	0 ~ 1	0: Error code 1: Warning code
DW	CTRLINF	DD	0 ~ 10	*Note4
DW	RBTW	D	1 ~ 9	X,Y,Z,U,V,W,R,S,T
DW	RBTJ	D	1 ~ 9	1,2,3,4,5,6,7,S,T
W	RBTP	D	1 ~ 9	1,2,3,4,5,6,7,S,T
W	SPEED	D	0 ~ 2	*Note5
W	ACCEL	D	0 ~ 5	*Note6
W	REALTRQ	D	1 ~ 9	Joint Number
DW	ATRQ	D	1 ~ 9	Joint Number
DW	PTRQ	D	1 ~ 9	Joint Number
DW	QLRATE	D	1 ~ 9	Joint Number

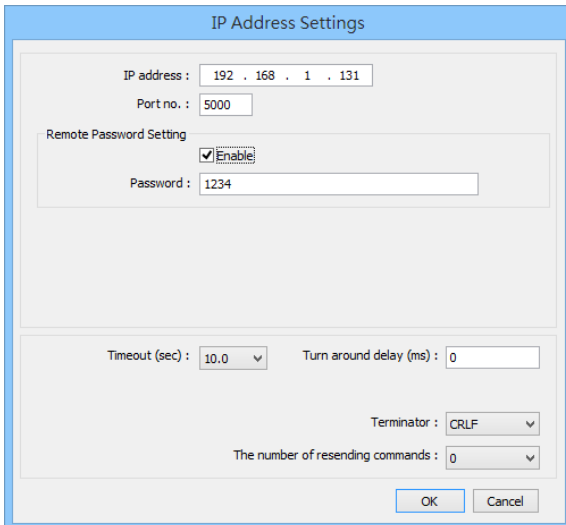
Bit/Word	Device type	Format	Range	Memo
W	CNT_NAME	DD	0 ~ 15	
W	CNT_NO	DD	0 ~ 15	
W	PRJ_NAME	DD	0 ~ 15	
W	MAIN_LIST	DD	0 ~ 65	*Note7
W	GET_TASK_INF	DD	0 ~ 59	*Note8
W	TASK_FUN_NAME	DDDD	100 ~ 5999	AABB AA: Existing task no. BB: Fill 00
W	TASK_STATUS	DDDD	100 ~ 5999	
W	TASK_TYPE	DDDD	100 ~ 5999	
W	TASK_START_TIME	DDDD	100 ~ 5999	
DW	TASK_EXE_LINE	DD	1 ~ 59	Existing task no.
W	GETMAIN	D	0	
W	IO_MAP	D	0	*Note9
W	GETIOSTR	HH	0 ~ A8	*Note10
W	GET_ERR_HIS_NUM	D	0	Number of history
W	ERR_HIS_CODE	DD	1 ~ 49	Error history no.
W	ERR_HIS_FUN_NAME	DDDD	100 ~ 4999	AABB AA: Error history no. BB: Fill 00
DW	ERR_HIS_LINE	DD	1 ~ 49	Error history no.
W	ERR_HIS_INT_CODE	DD	1 ~ 49	Error history no.
W	ERR_HIS_TIME	DDDD	100 ~ 4999	AABB AA: Error history no. BB: Fill 00
W	ERR_HIS_ROBOT_NO	DD	1 ~ 49	Error history no.
W	ERR_HIS_AXIS_NO	DD	1 ~ 49	Error history no.
W	ERR_HIS_TASK_NO	DD	1 ~ 49	Error history no.
W	ERR_HIS_INFO1	DDDD	100 ~ 4999	AABB AA: Error history no. BB: Fill 00
W	ERR_HIS_INFO2	DDDD	100 ~ 4999	AABB AA: Error history no. BB: Fill 00
W	ERR_HIS_MESSAGE	DDDD	100 ~ 4999	AABB AA: Error history no. BB: Fill 00
W	ERR_MESSAGE	DDDD	0 ~ 9999	

Bit/Word	Device type	Format	Range	Memo
W	PFILELIST	DDDDDD	10000 ~ 169999	AABBCC AA: Robot no. BB: File index CC: Fill 00
W	LOADPFILE	DDDDD	100 ~ 16099	AABB AA:Robot no BB: Fill 00
W	GETPINF	DD	0 ~ 54	0: Write 1 to read 1: Robot no. 2: Stat point no. 3: End point no. 4: number of points 5~54: point
W	PINF_POINT_NO	DD	0 ~ 49	Point
DW	PINF_X_COORDINATE	DD	0 ~ 49	
DW	PINF_Y_COORDINATE	DD	0 ~ 49	
DW	PINF_Z_COORDINATE	DD	0 ~ 49	
DW	PINF_U_COORDINATE	DD	0 ~ 49	
DW	PINF_V_COORDINATE	DD	0 ~ 49	
DW	PINF_W_COORDINATE	DD	0 ~ 49	
DW	PINF_R_COORDINATE	DD	0 ~ 49	
DW	PINF_S_COORDINATE	DD	0 ~ 49	
DW	PINF_T_COORDINATE	DD	0 ~ 49	
W	PINF_HAND	DD	0 ~ 49	0: Error 1: Lefty 2: Righty
W	PINF_ELBOW	DD	0 ~ 49	0: Error 1: Below 2: Ablow
W	PINF_WRIST	DD	0 ~ 49	0: Error 1: Flip 2: No. flip
W	PINF_J4FLAG	DD	0 ~ 49	
W	PINF_J6FLAG	DD	0 ~ 49	
W	PINF_J1FLAG	DD	0 ~ 49	
W	PINF_J2FLAG	DD	0 ~ 49	
W	PINF_J1ANGLE	DD	0 ~ 49	

Bit/Word	Device type	Format	Range	Memo
W	RBTINF_NUM	D	0	1 ~ 16
W	RBTINF_TYPE	DD	1 ~ 16	
W	RBTINF_MODEL_NAME	DDDD	100 ~ 1699	AA: 1~16 BB: Fill 00
DW	ENET_TOTAL_TIME	D	0	
DW	ENET_POWER_ON_TIME	D	0	
DW	EXTTIME_MOTOR_ON	DD	1 ~ 16	
DW	EXTTIME_MOTOR_ON_NUM	DD	1 ~ 16	
DW	X_STEP_DISTANCE	D	0	Step distance control
DW	Y_STEP_DISTANCE	D	0	
DW	Z_STEP_DISTANCE	D	0	
DW	U_STEP_DISTANCE	D	0	
DW	V_STEP_DISTANCE	D	0	
DW	W_STEP_DISTANCE	D	0	
DW	J1_STEP_DISTANCE	D	0	
DW	J2_STEP_DISTANCE	D	0	
DW	J3_STEP_DISTANCE	D	0	
DW	J4_STEP_DISTANCE	D	0	
DW	J5_STEP_DISTANCE	D	0	
DW	J6_STEP_DISTANCE	D	0	
W	GO	D	0	
W	JUMP	D	0	
W	JUMP3	D	0 ~ 3	0: write1 to excute 1~3: point
W	JUMP3CP	D	0 ~ 3	0: write1 to excute 1~3: point
W	MOVE	D	0	
W	ARC	D	0 ~ 2	0: write1 to excute 1~2: point
W	ARC3	D	0 ~ 2	0: write1 to excute 1~2: point
W	T_POINT	D	0 ~ 1	
W	SELECT_POINT_FILE	DD	1 ~ 16	
W	J1FLAG	D	0	
W	J4FLAG	D	0	
W	J6FLAG	D	0	

Note1:

勾選 Remote Password Setting 時，會直接複製設定的密碼到此地址



The screenshot shows the 'IP Address Settings' dialog box. It contains the following fields and values:

- IP address: 192 . 168 . 1 . 131
- Port no.: 5000
- Remote Password Setting: Enable
- Password: 1234
- Timeout (sec): 10.0
- Turn around delay (ms): 0
- Terminator: CRLF
- The number of resending commands: 0

Note2:

Address	Bit	Description
0	0-15	Task 1 - 16 are executing (Xqt) or Halt condition
	16	Task is executing
	17	Pause condition
	18	Error condition
	19	TEACH mode
	20	Emergency stop condition
	21	Low power mode (Power Low)
	22	Safety door input is open
	23	Enable switch is open
1	0	Conditional approval of Jump...Sense statement at history of target coordinates over the suspension. (Jump statements then executed this history is cleared.)
	1	Conditional approval of Go/Jump/Move...Till statement at history of operating suspend. (Go/Jump/Move...Till statements then executed this history is cleared.)
	2	Undefined
	3	Conditional approval of Trap statement at history of operating suspend
	4	Motor On condition
	5	Home position at currently

Address	Bit	Description
	6	Low power condition
	7	Undefined
	8	Joint 4 motor is on
	9	Joint 3 motor is on
	10	Joint 2 motor is on
	11	Joint 1 motor is on
	12	Joint 6 motor is on
	13	Joint 5 motor is on
	14	Joint T motor is on
	15	Joint S motor is on
	16	Joint 7 motor is on
2	0-15	Task 17 - 32 are executing (Xqt) or Halt condition

Note3:

Address	Bit	Description
0	0	Undefined
	1	Resettable error occur
	2	Unresettable error occur
	3	Motor ON
	4	Power High
	8	Robot is Halt condition
	9	Robot is not Halt condition (operating or quick pausing)
	10	Roboy is stop at pausing or safety door
	14	Meet TILL condition, after operation command
	15	Meet SENSE condition, after operation command
1	0	In the follow-up operation (In the conveyor tracking)
	1	Wait for return action (WaitRecover condition)
	2	Return action is executing
2	0	Robot is home position
3	0	Joint 1 servo is on
	1	Joint 2 servo is on
	2	Joint 3 servo is on
	3	Joint 4 servo is on
	4	Joint 5 servo is on
	5	Joint 6 servo is on
	6	Joint 7 servo is on
	7	Joint S servo is on

Address	Bit	Description
	8	Joint T servo is on
4	N/A	It is a task number executing a robot command. 0 = Execute the command from command window or macro. -1 = Task or manipulator is unused.
5	0	Joint 1 brake is on
	1	Joint 2 brake is on
	2	Joint 3 brake is on
	3	Joint 4 brake is on
	4	Joint 5 brake is on
	5	Joint 6 brake is on
	6	Joint 7 brake is on
	7	Joint S brake is on
	8	Joint T brake is on

Note4:

IO_LABEL data format = A.B.CCCCC.DD (Max: 226553599)

A: IO type: 0 (Input) , 1 (Output) , 2 (Memory)

B: IO width: 0 (Bit) , 1 (Byte) , 2 (Word)

C: Port No.: 0 ~ 65535

D: Fill 00

Note5:

0: PTP motion percent speed[%]

1: Jump depart speed[%]

2: Jump approach speed[%]

Note6:

0: acceleration specification value

1: deceleration specification value

2: depart acceleration specification value for Jump

3: depart deceleration specification value for Jump

4: approach acceleration specification value for Jump

5: approach deceleration specification value for Jump

Note7:

0: Number of function in program

1~65: Existing function no.

Note8:

0: Number of task

1~65: Existing task no.

Note9:

Address	Bit	Description
1	0	Ready condition
	1	Start condition
	2	Pause condition
	8	Emergency stop condition
	9	Safety door open condition
	10	Error condition
	11	Fatal error condition
	12	Warning condition
	13	WaitRecover condition (It is waiting return from safe door open)
	14	Recover condition (It is executing return from safe door open)
2	0	Enable switch of TP1 is ON
3	0	TEACH mode circuit failure detection
	1	Safety door circuit failure detection
	2	Emergency stop circuit failure detection
4	N/A	0: Real run mode, 1: Dry run mode
5	N/A	Control device 21: RC+, 22: Remote, 26: Remote Ethernet, 29: Remote RS232C
6	N/A	Number of the set robot
7	N/A	Operation mode 0: Programing mode, 1: AUTO mode
9	N/A	Firm ware version of the controller Major number*1000000 + Minor number*10000 + Revision number*100 + Build number Example: In the case of 1.6.2.4 1060204
10	N/A	SMART status of the hard disk 0: SMART status is normal, 1: SMART status is abnormal When SMART status is abnormal, the hard disk may break down, back up data immediately, and use a new hard disk. You cannot use SMART status when you use RAID. It will always return Normal.

Note10:

Data format: XY (X: 0 ~ A, Y: 0 ~ 8)

X0: Memory I/O

X1: Standard I/O

X2: Drive unit1

X3: Drive unit2

X4: Drive unit3

X5: Expansion I/O-1

X6: Expansion I/O-2

X7: Expansion I/O-3

X8: Expansion I/O-4

X9: Fieldbus master

XA: Fieldbus slave

Y0 ~ 8:

Bit	Description
0	Exist I/O? 0: Not exist.(0 is set to IOSTRUCR*.1 - 8) 1: 1data Exist.(0 is set to IOSTRUCR*.5 - 8) 2: 2data Exist. (Input/Output are separated.)
1	I/O type 0: Memory I/O 1: Standard I/O 2: Drive units1 3: Drive units2 4: Drive units3 5: Expansion I/O-1 6: Expansion I/O-2 7: Expansion I/O-3 8: Expansion I/O-4 9: Fieldbus master A: Fieldbus slave
2	Input / Output 0: Input 1: Output 2: Input and Output
3	Start number.

Bit	Description
4	Memory size
5	Input / Output(2) 0: Input 1: Output 2: Input and Output
7	Start number. (2)
8	Memory size (2)

Note11:

0: Remote ethernet is not a console device

1: Remote ethernet is a console device

Wiring Diagram:

Diagram 1

Ethernet cable:



Fanuc 0i/30i/31i/32i/35i Series

Supported Series: Fanuc 0i/30i/31i/32i/35i Series

Website: http://www.fanucfa.com/welcome_worldwide/

HMI Setting:

Parameters	Recommended	Options	Notes
PLC type	Fanuc 0i/30i/31i/32i/35i Series		
PLC I/F	RS232		
Baud rate	19200		
Data bits	8		
Parity	Even		
Stop bits	1		
PLC sta. no.	0		

On-line simulation	YES
---------------------------	-----

PLC Setting:

Reader/Puncher interface (2ch.) is used for touch panel interface.

External touch panel interface, S/N: A02B-0320-J685, for Power Mate Series.

Device Address:

Bit/Word	Device type	Format	Range	Memo
B	X	DDDDo	0 ~ 11277	
B	Y	DDDDo	0 ~ 11277	
B	K	DDDo	0 ~ 9997	
B	E	DDDDo	0 ~ 99997	
B	D_Bit	DDDDo	0 ~ 99997	
B	R_Bit	DDDDo	0 ~ 94997	
W	T	DDDD	0 ~ 9499	Must be a multiple of 2
W	C	DDDD	0 ~ 5199	Must be a multiple of 4
W	D_Byte	DDDD	0 ~ 9999	
W	R_Byte	DDDD	0 ~ 9499	
W	D	DDDD	0 ~ 9999	Must be a multiple of 2
W	R	DDDD	0 ~ 9499	Must be a multiple of 2

Wiring Diagram:

The following is the view from the soldering point of a connector.



Diagram 1

cMT Series	<i>cMT3151</i>
eMT Series	<i>eMT3070/ eMT3105 / eMT3120 / eMT3150</i>
MT-iE	<i>MT8073iE / MT8102iE</i>
MT-XE	<i>MT8092XE</i>
MT-iP	<i>MT6103iP</i>

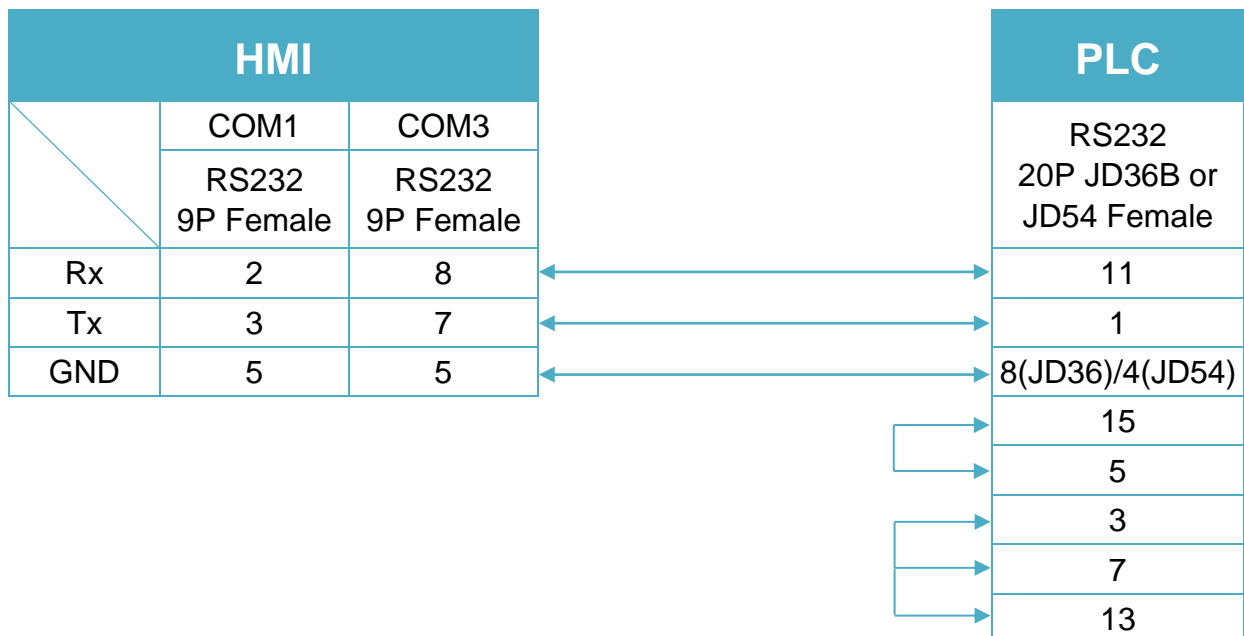


Diagram 2

cMT Series	cMT-SVR
mTV	mTV
MT-iE	MT8070iE / MT6070iE / MT8100iE / MT8121iE / MT8150iE / MT8071iE / MT6071iE / MT8072iE / MT6072iE / MT8073iE / MT8101iE / MT8102iE / MT8103iE
MT-XE	MT8121XE / MT8150XE / MT8090XE

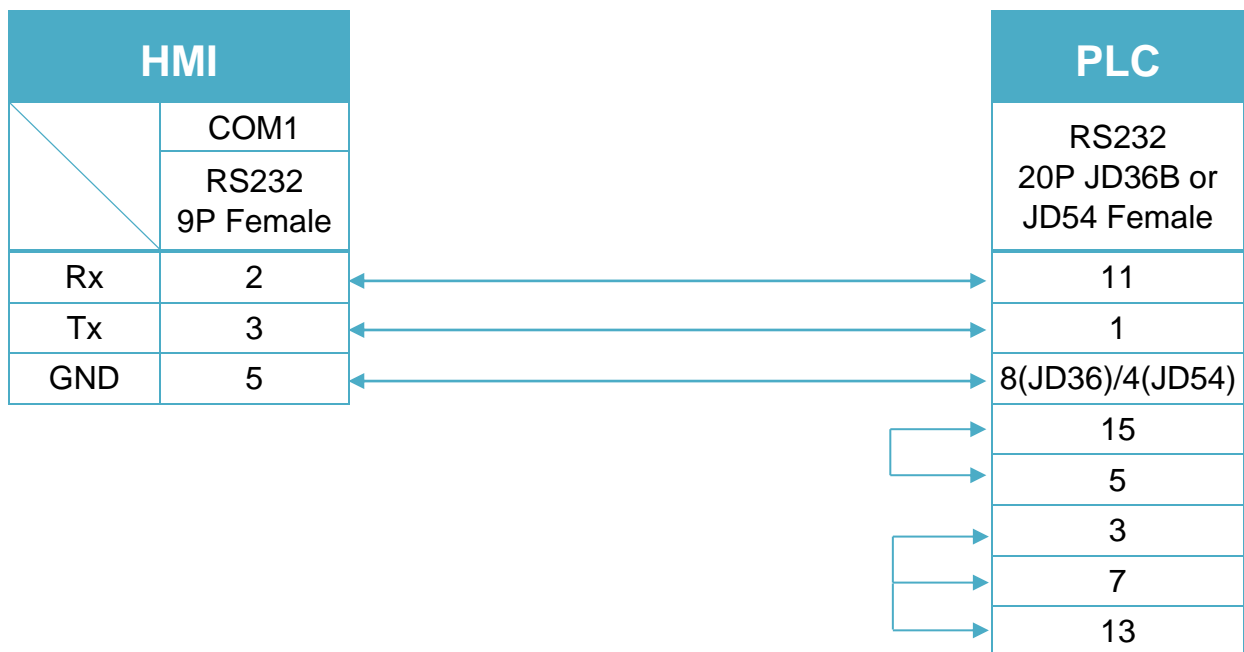
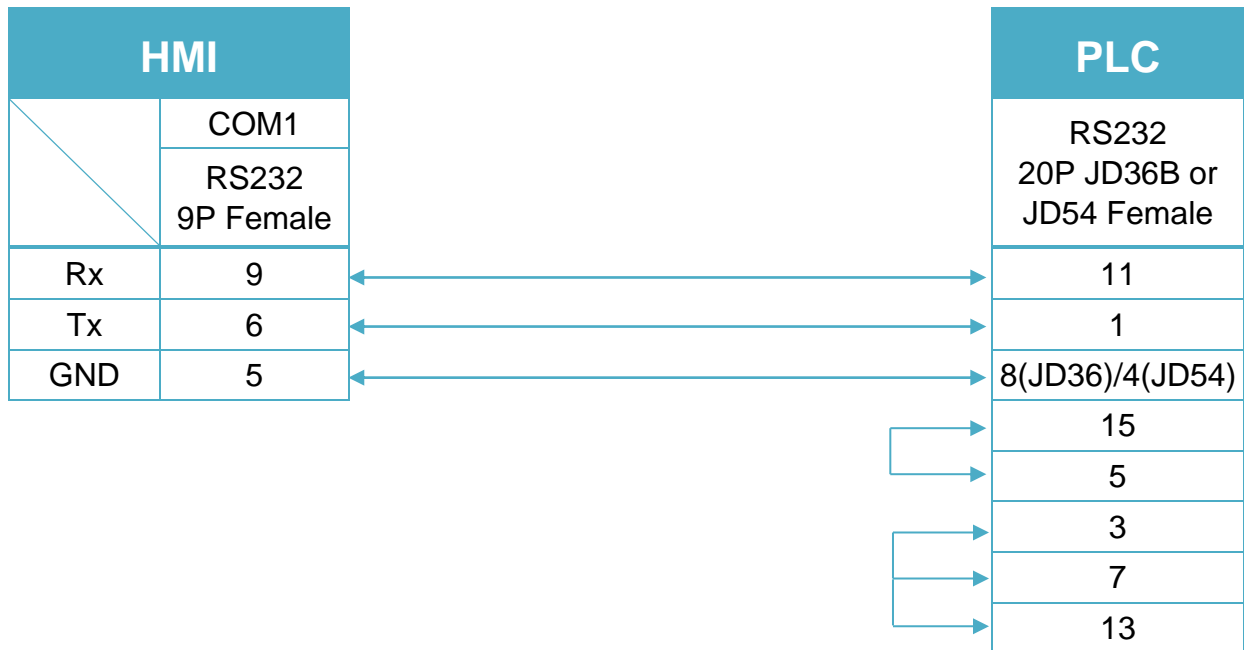


Diagram 3

MT-iE
MT8050iE
MT-iP
MT6051iP / MT6071iP / MT8071iP


Fanuc 0i/30i/31i/32i/35i Series (Ethernet)

Supported Series: Fanuc 0i/30i/31i/32i/35i Series

Website: http://www.fanucfa.com/welcome_worldwide/

HMI Setting:

Parameters	Recommended	Options	Notes
PLC type	Fanuc 0i/30i/31i/32i/35i Series (Ethernet)		
PLC I/F	Ethernet		
Port no.	8193		
PLC sta. no.	1		

Device Address:

Bit/Word	Device type	Format	Range	Memo
B	G_Bit	DDDDo	0 ~ 99997	
B	F_Bit	DDDDo	0 ~ 99997	
B	Y_Bit	DDDDo	0 ~ 99997	
B	X_Bit	DDDDo	0 ~ 99997	
B	A_Bit	DDDDo	0 ~ 99997	
B	R_Bit	DDDDo	0 ~ 99997	
B	T_Bit	DDDDo	0 ~ 99997	
B	K_Bit	DDDDo	0 ~ 99997	
B	C_Bit	DDDDo	0 ~ 99997	
B	D_Bit	DDDDo	0 ~ 99997	
B	M_Bit	DDDDo	0 ~ 99997	
B	N_Bit	DDDDo	0 ~ 99997	
B	E_Bit	DDDDo	0 ~ 99997	
W	G_String	DDDD	0 ~ 9999	
W	F_String	DDDD	0 ~ 9999	
W	Y_String	DDDD	0 ~ 9999	
W	X_String	DDDD	0 ~ 9999	
W	A_String	DDDD	0 ~ 9999	
W	R_String	DDDD	0 ~ 9999	
W	T_String	DDDD	0 ~ 9999	
W	K_String	DDDD	0 ~ 9999	
W	C_String	DDDD	0 ~ 9999	

Bit/Word	Device type	Format	Range	Memo
W	D_String	DDDD	0 ~ 9999	
W	M_String	DDDD	0 ~ 9999	
W	N_String	DDDD	0 ~ 9999	
W	E_String	DDDD	0 ~ 9999	
W	G	DDDD	0 ~ 9999	
W	F	DDDD	0 ~ 9999	
W	Y	DDDD	0 ~ 9999	
W	X	DDDD	0 ~ 9999	
W	A	DDDD	0 ~ 9999	
W	R	DDDD	0 ~ 9999	
W	T	DDDD	0 ~ 9999	
W	K	DDDD	0 ~ 9999	
W	C	DDDD	0 ~ 9999	
W	D	DDDD	0 ~ 9999	
W	M	DDDD	0 ~ 9999	
W	N	DDDD	0 ~ 9999	
W	E	DDDD	0 ~ 9999	
Byte	GB	DDDD	0 ~ 9999	
Byte	FB	DDDD	0 ~ 9999	
Byte	YB	DDDD	0 ~ 9999	
Byte	XB	DDDD	0 ~ 9999	
Byte	AB	DDDD	0 ~ 9999	
Byte	RB	DDDD	0 ~ 9999	
Byte	TB	DDDD	0 ~ 9999	
Byte	KB	DDDD	0 ~ 9999	
Byte	CB	DDDD	0 ~ 9999	
Byte	DB	DDDD	0 ~ 9999	
Byte	MB	DDDD	0 ~ 9999	
Byte	NB	DDDD	0 ~ 9999	
Byte	EB	DDDD	0 ~ 9999	
W	G_Odd	DDDD	0 ~ 9999	
W	F_Odd	DDDD	0 ~ 9999	
W	Y_Odd	DDDD	0 ~ 9999	
W	X_Odd	DDDD	0 ~ 9999	
W	A_Odd	DDDD	0 ~ 9999	
W	R_Odd	DDDD	0 ~ 9999	
W	T_Odd	DDDD	0 ~ 9999	

Bit/Word	Device type	Format	Range	Memo
W	K_Odd	DDDD	0 ~ 9999	
W	C_Odd	DDDD	0 ~ 9999	
W	D_Odd	DDDD	0 ~ 9999	
W	M_Odd	DDDD	0 ~ 9999	
W	N_Odd	DDDD	0 ~ 9999	
W	E_Odd	DDDD	0 ~ 9999	
W	ABSOLUTE_POSITION	D	1 ~ 8	
W	MACHINE_POSITION	D	1 ~ 8	
W	RELATIVE_POSITION	D	1 ~ 8	
W	DISTANCE_TO_GO	D	1 ~ 8	
W	SERVO_LOAD	D	1 ~ 8	
W	SPINDLE	D	0 ~ 1	
W	FEED_RATE	D	0	
W	ALARM	D	0 ~ 9	
W	TOOL_OFFSET	DDDD.DDDD	0 ~ 9999.9999	
W	WORK_ZERO_OFFSET	DDD.DDD	0 ~ 999.999	
W	PMC_TIMER_TYPE	DDD	1 ~ 250	
W	MACRO_VALUE	DDDD	1 ~ 9999	

Wiring Diagram:

Diagram 1

Ethernet cable:



FATEK FB/FBs/B1/B1z Series

Supported Series: FATEK FB/FBs/B1/B1z series, FB MC series, and FB MA series need FB-DTBR converter.

Website: <http://www.fatek.com/>

HMI Setting:

Parameters	Recommended	Options	Notes
PLC type	FATEK FB/FBs/B1/B1z Series		
PLC I/F	RS232	RS232/RS485/Ethernet	
Baud rate	9600		
Data bits	7		
Parity	Even		
Stop bits	1		
PLC sta. no.	1	0-255	Must match PLC port setting.
Port no.	500		Ethernet only.

*Support communications between HMI and PLC in pass-through mode

*Set LW-9903 to 2 to enhance the speed of download/upload PLC program in pass-through mode

Device Address:

Bit/Word	Device type	Format	Range	Memo
B	X	DDDD	0 ~ 9999	Input
B	Y	DDDD	0 ~ 9999	Output
B	M	DDDD	0 ~ 9999	Internal Relay
B	S	DDDD	0 ~ 9999	Step Relay
B	T	DDDD	0 ~ 9999	Timer
B	C	DDDD	0 ~ 9999	Counter
B	PLC_MODE	D	0	PLC mode
B	R_Bit	DDDDdd	0 ~ 999915	
B	D_Bit	DDDDdd	0 ~ 999915	
W	RT	DDDD	0 ~ 9999	Timer Register
W	RC	DDDD	0 ~ 9999	Counter Register
W	R	DDDD	0 ~ 9999	Data Register
W	D	DDDD	0 ~ 9999	Data Register
W	DRT	DDDD	0 ~ 9999	Double Word Timer Register
W	DRC	DDD	200 ~ 255	Double Word Counter Register

Bit/Word	Device type	Format	Range	Memo
W	WX	DDDD	0 ~ 9999	Input Word
W	WY	DDDD	0 ~ 9999	Output Word
W	WM	DDDD	0 ~ 9999	Internal Relay Word
W	WS	DDDD	0 ~ 9999	
W	FR	DDDD	0 ~ 9999	

Wiring Diagram:

The following is the view from the soldering point of a connector.

FBs Port0: RS-232 4P Mini-DIN (Diagram 1 ~ Diagram 3)



Diagram 1

cMT Series	<i>cMT3151</i>
eMT Series	<i>eMT3070 / eMT3105 / eMT3120 / eMT3150</i>
MT-iE	<i>MT8073iE / MT8102iE</i>
MT-XE	<i>MT8092XE</i>
MT-iP	<i>MT6103iP</i>

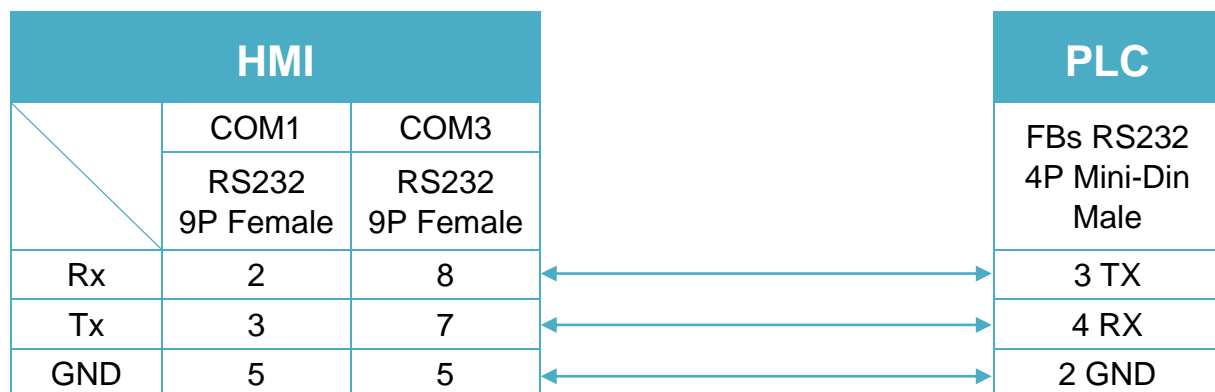


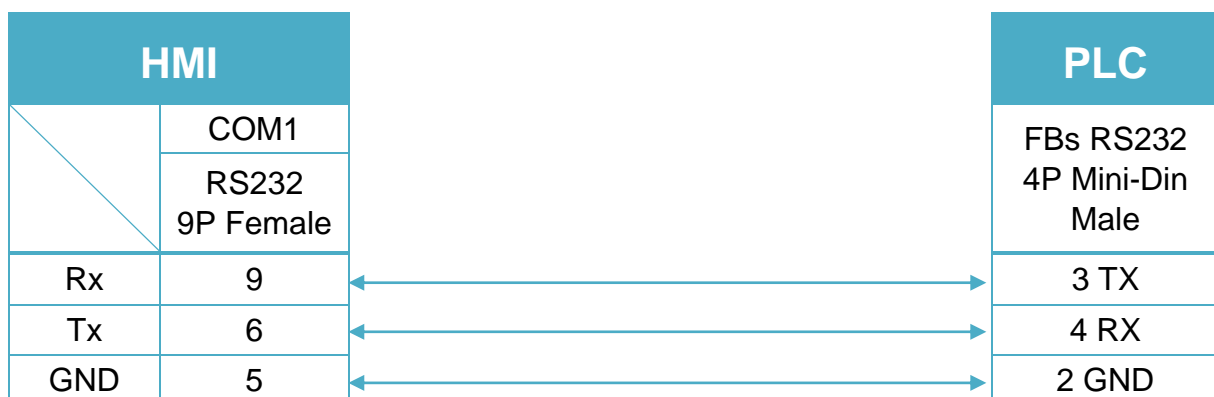
Diagram 2

cMT Series	cMT-SVR
mTV	mTV
MT-iE	MT8070iE / MT6070iE / MT8100iE / MT8121iE / MT8150iE / MT8071iE / MT6071iE / MT8072iE / MT6072iE / MT8073iE / MT8101iE / MT8102iE / MT8103iE
MT-XE	MT8121XE / MT8150XE / MT8090XE



Diagram 3

MT-iE	MT8050iE
MT-iP	MT6051iP / MT6071iP / MT8071iP



FBs communication module: RS-232 9P D-Sub (Diagram 4 ~ Diagram 6)

Diagram 4

cMT Series	<i>cMT3151</i>
eMT Series	<i>eMT3070 / eMT3105 / eMT3120 / eMT3150</i>
MT-iE	<i>MT8073iE / MT8102iE</i>
MT-XE	<i>MT8092XE</i>
MT-iP	<i>MT6103iP</i>

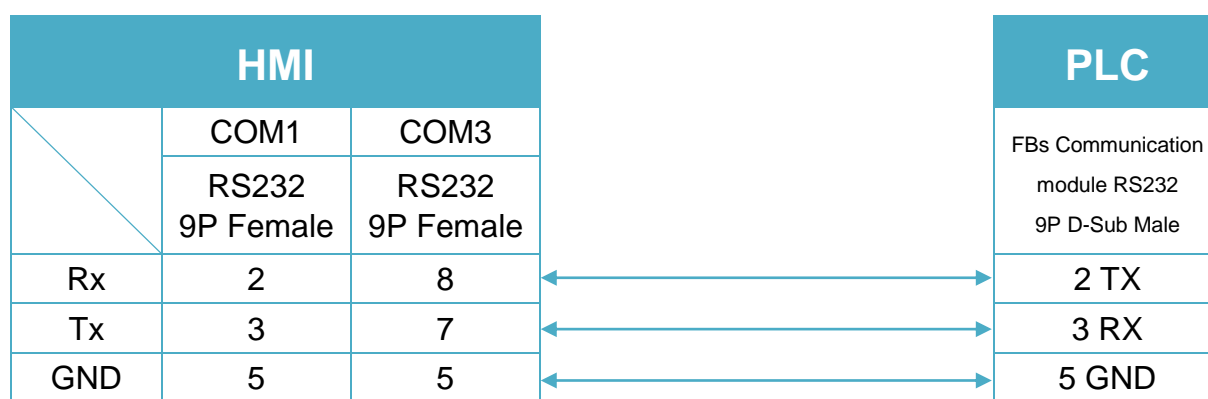


Diagram 5

cMT Series	<i>cMT-SVR</i>
mTV	<i>mTV</i>
MT-iE	<i>MT8070iE / MT6070iE / MT8100iE / MT8121iE / MT8150iE / MT8071iE / MT6071iE / MT8072iE / MT6072iE / MT8073iE / MT8101iE / MT8102iE / MT8103iE</i>
MT-XE	<i>MT8121XE / MT8150XE / MT8090XE</i>

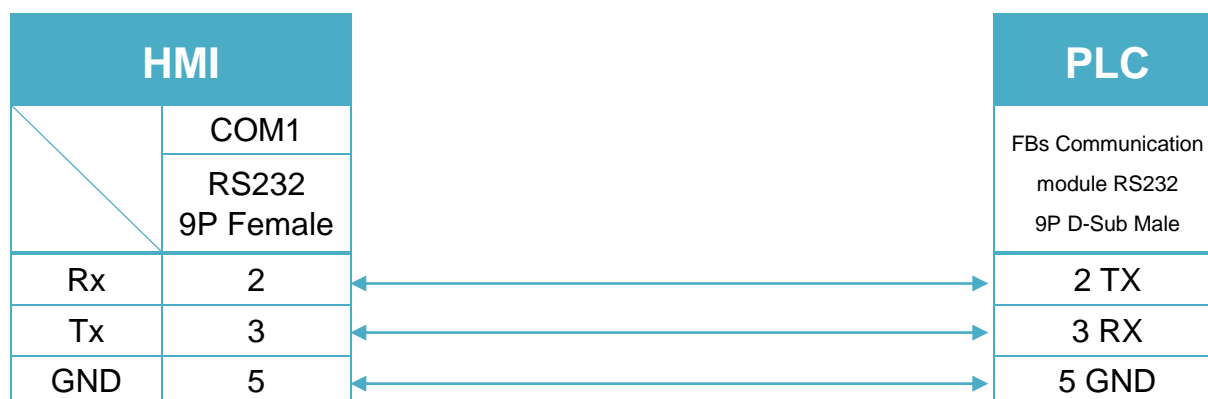


Diagram 6

MT-iE	MT8050iE
MT-iP	MT6051iP / MT6071iP / MT8071iP



FBs communication module 3P Terminal Block: RS-485 2W Terminal (Diagram 7 ~ Diagram 12)

Diagram 7

cMT Series	cMT3151
eMT Series	eMT3070 / eMT3105 / eMT3120 / eMT3150

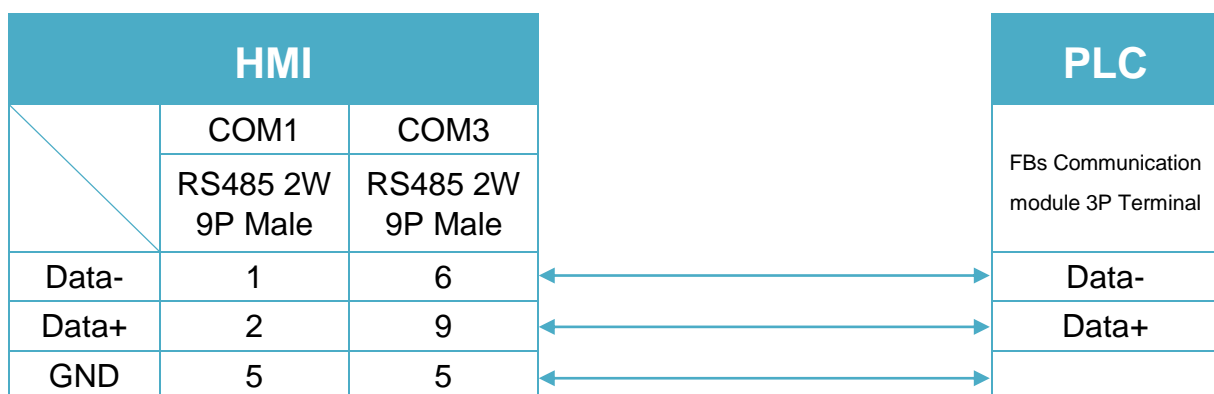


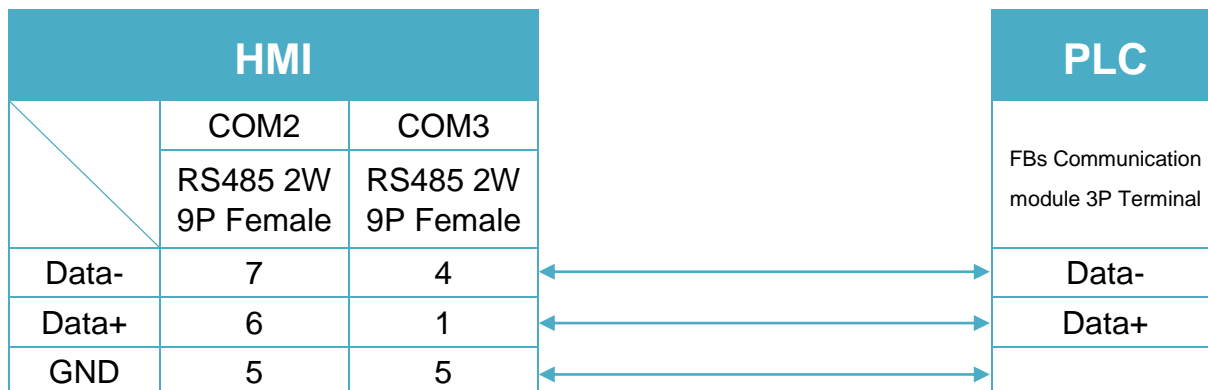
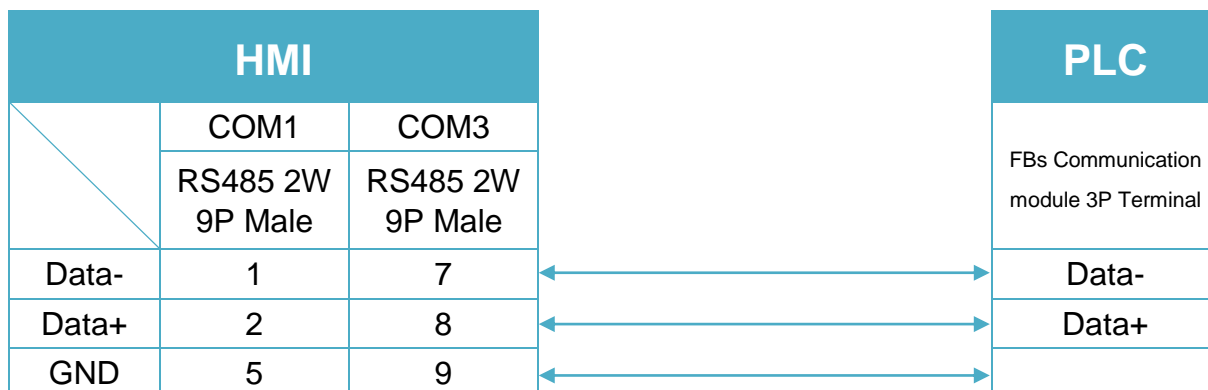
Diagram 8
cMT Series
cMT-SVR
mTV
mTV

Diagram 9
MT-iE
MT8070iE / MT6070iE / MT8100iE / MT8121iE / MT8150iE
MT-XE
MT8121XE / MT8150XE


Diagram 10

MT-iE	<i>MT8071iE / MT6071iE / MT8072iE / MT6072iE / MT8073iE / MT8101iE / MT8102iE / MT8103iE</i>
MT-XE	<i>MT8090XE / MT8092XE</i>
MT-iP	<i>MT6103iP</i>

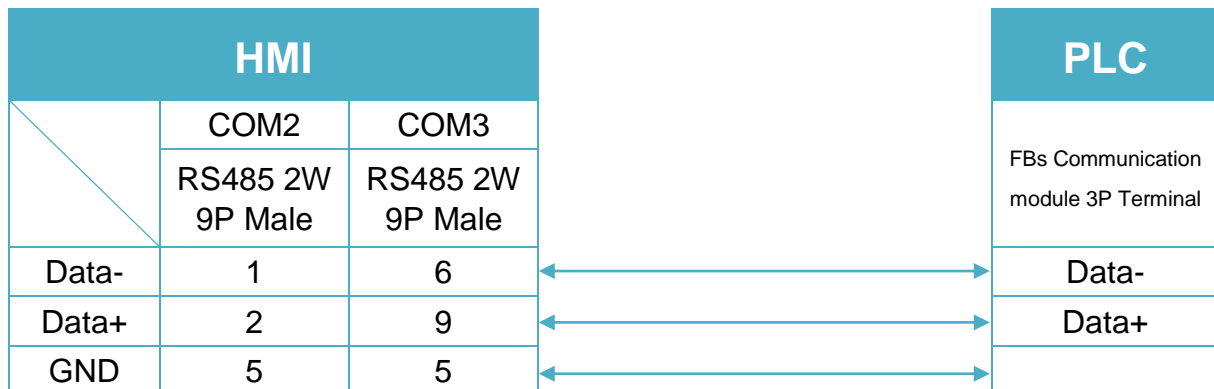


Diagram 11

MT-iE	<i>MT8050iE</i>
MT-iP	<i>MT6051iP</i>

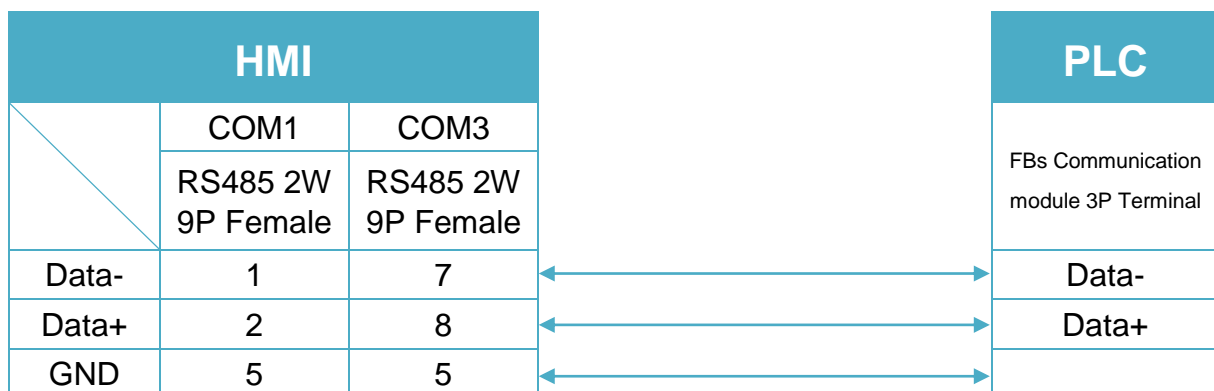


Diagram 12

MT-iP *MT6071iP / MT8071iP*



CPU Port: RS-232 15P D-Sub (Diagram 13 ~ Diagram 15)

Diagram 13

cMT Series *cMT3151*

eMT Series *eMT3070 / eMT3105 / eMT3120 / eMT3150*

MT-iE *MT8073iE / MT8102iE*

MT-XE *MT8092XE*

MT-iP *MT6103iP*

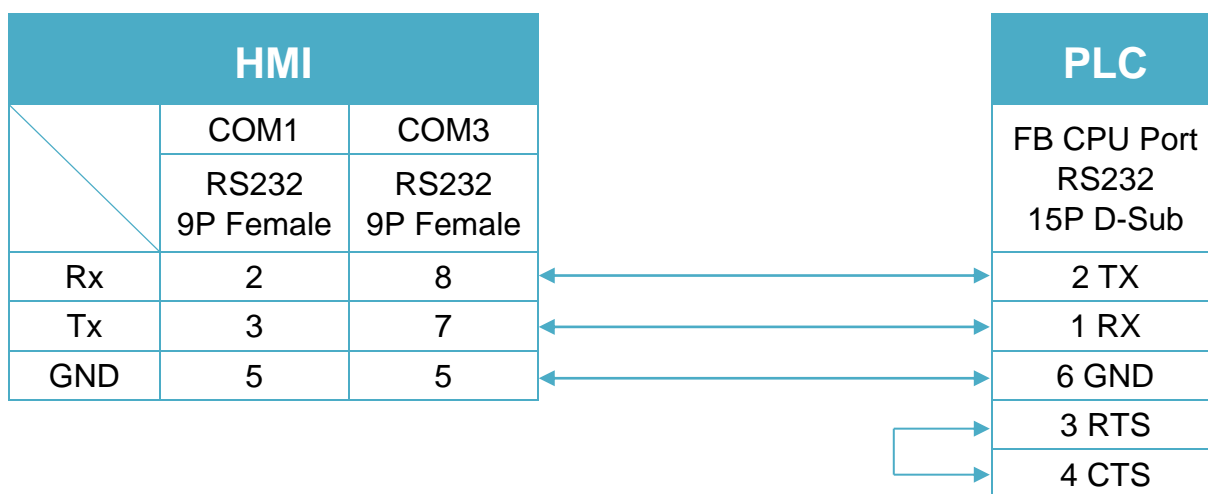


Diagram 14

cMT Series	cMT-SVR
mTV	mTV
MT-iE	MT8070iE / MT6070iE / MT8100iE / MT8121iE / MT8150iE / MT8071iE / MT6071iE / MT8072iE / MT6072iE / MT8073iE / MT8101iE / MT8102iE / MT8103iE
MT-XE	MT8121XE / MT8150XE / MT8090XE

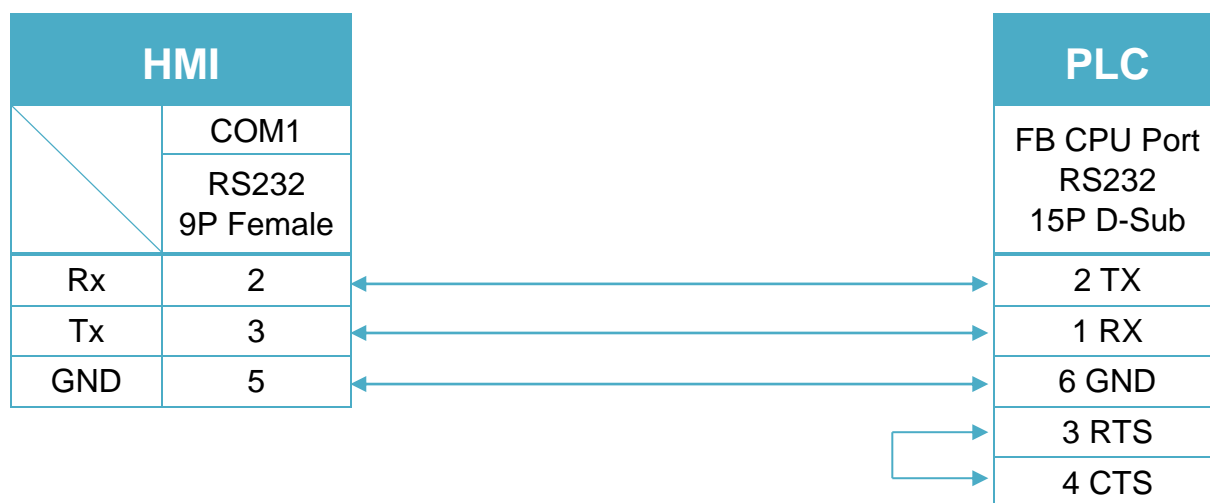
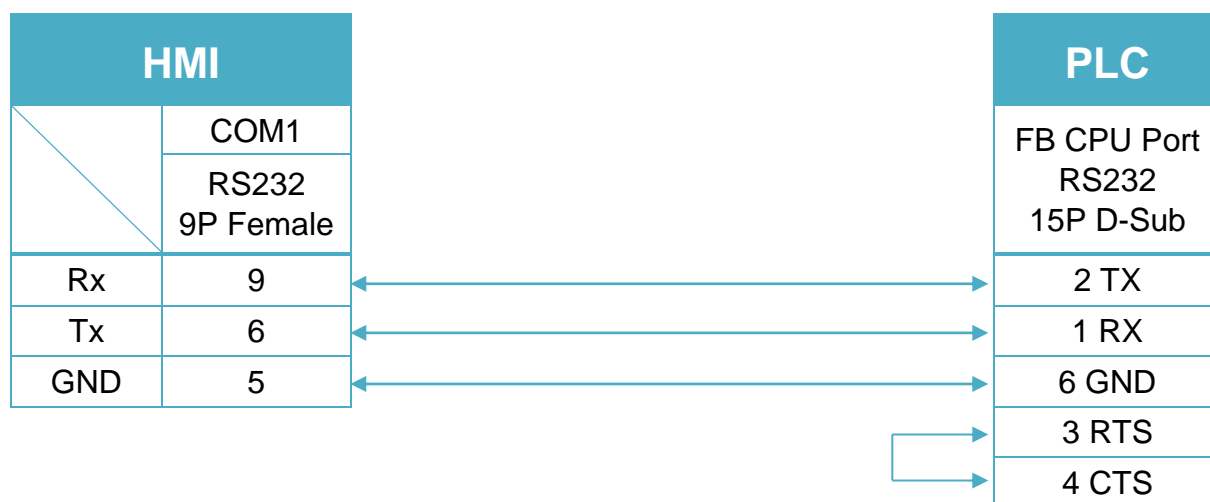


Diagram 15

MT-iE	MT8050iE
MT-iP	MT6051iP / MT6071iP / MT8071iP



CPU Port: RS-485 2W 15P D-Sub (Diagram 16 ~ Diagram 21)

Diagram 16

cMT Series *cMT3151*

eMT Series *eMT3070 / eMT3105 / eMT3120 / eMT3150*

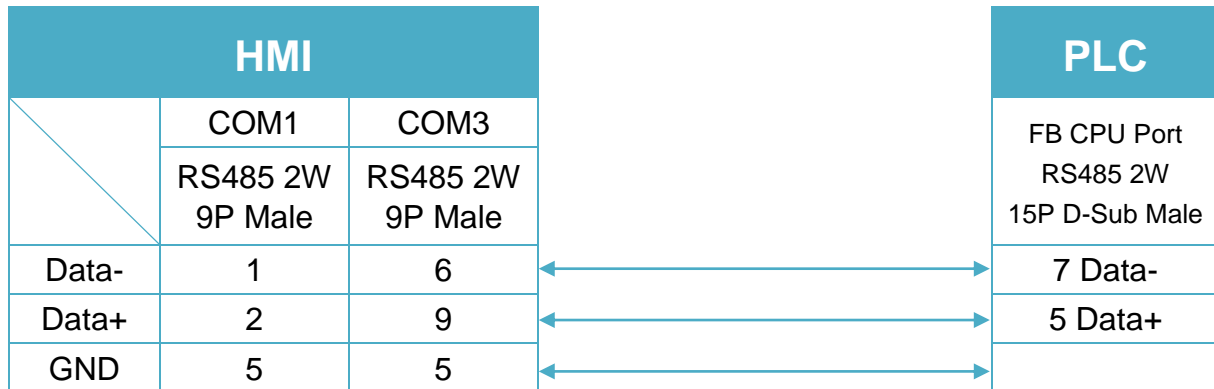


Diagram 17

cMT Series *cMT-SVR*

mTV *mTV*

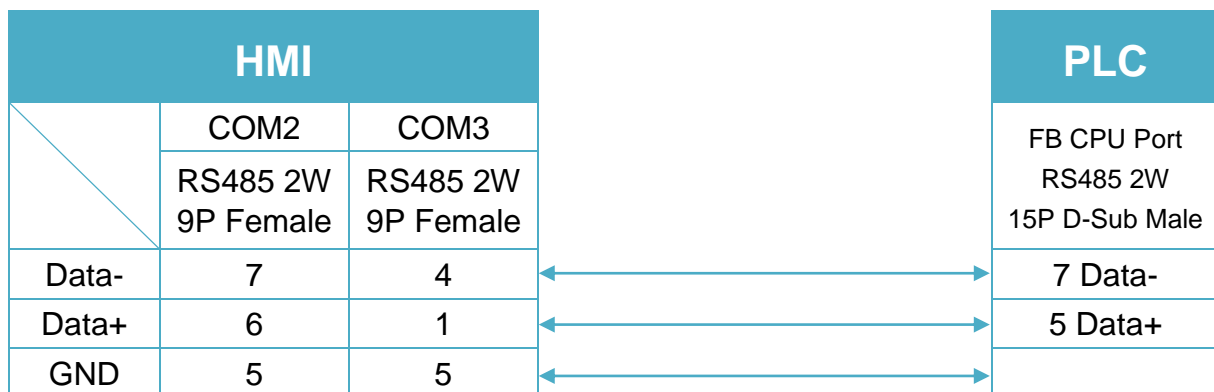


Diagram 18

MT-iE *MT8070iE / MT6070iE / MT8100iE / MT8121iE / MT8150iE*

MT-XE *MT8121XE / MT8150XE*

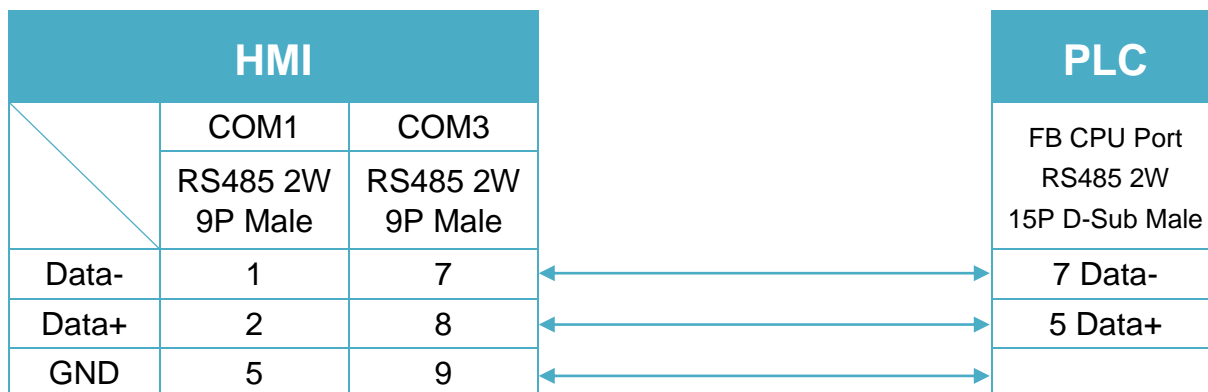


Diagram 19

MT-iE *MT8071iE / MT6071iE / MT8072iE / MT6072iE / MT8073iE /
MT8101iE / MT8102iE / MT8103iE*

MT-XE *MT8090XE / MT8092XE*

MT-iP *MT6103iP*

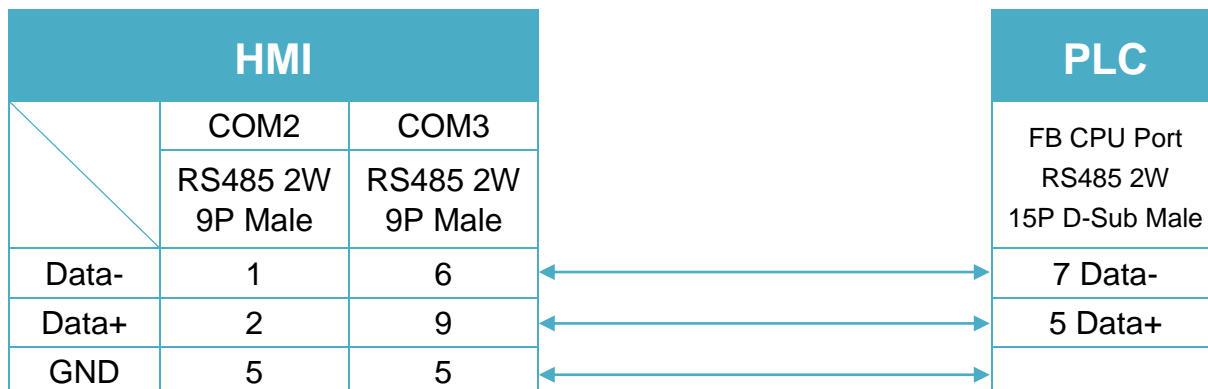


Diagram 20

MT-iE *MT8050iE*

MT-iP *MT6051iP*

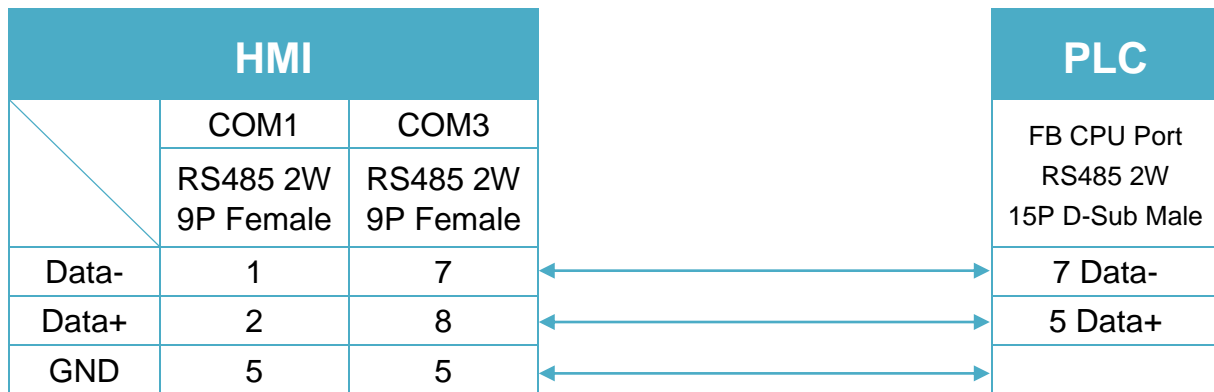


Diagram 21

MT-iP *MT6071iP / MT8071iP*



Diagram 22

Ethernet cable:



Fuji NB Series

Website: <http://www.fujielectric.com/fcs/index.html>

HMI Setting:

Parameters	Recommended	Options	Notes
PLC type	Fuji NB Series		
PLC I/F	RS485 4W		
Baud rate	19200		
Data bits	8		
Parity	Odd		
Stop bits	1		
PLC sta. no.	0		

PLC Setting:

Communication mode	NITP Protocol / PLC Password (default is 0)
---------------------------	---

Device Address:

Bit/Word	Device type	Format	Range	Memo
B	Y	HHH	0 ~ 7ff	Output Relay
B	X	HHH	0 ~ 3ff	Input Relay
B	M	HHH	0 ~ fff	Internal Relay
B	L	HHH	0 ~ fff	Latch Relay
B	C	HH	0 - ff	Counter
B	M_Spe	HHHH	0 ~ 81ff	Special Relay
B	T	HHH	0 ~ 1ff	Timer
W	TV	HHH	0 ~ 3ff	Timer value
W	CV	HHH	0 ~ 3ff	Counter value
W	D	HHHH	0 ~ 1fff	Data Register
W	D_Spe	HHHH	0 ~ 81ff	Special Register

Wiring Diagram:

Diagram 1

cMT Series	<i>cMT3151</i>
eMT Series	<i>eMT3070 / eMT3105 / eMT3120 / eMT3150</i>
MT-iE	<i>MT8070iE / MT6070iE / MT8100iE / MT8121iE / MT8150iE</i>
MT-XE	<i>MT8121XE / MT8150XE</i>

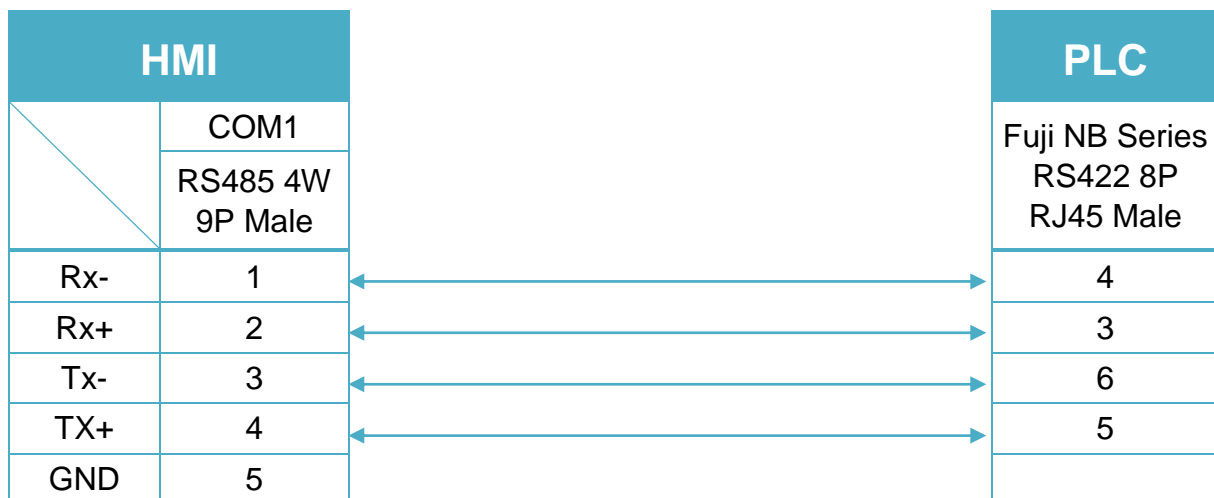


Diagram 2

cMT Series	<i>cMT-SVR</i>
mTV	<i>mTV</i>

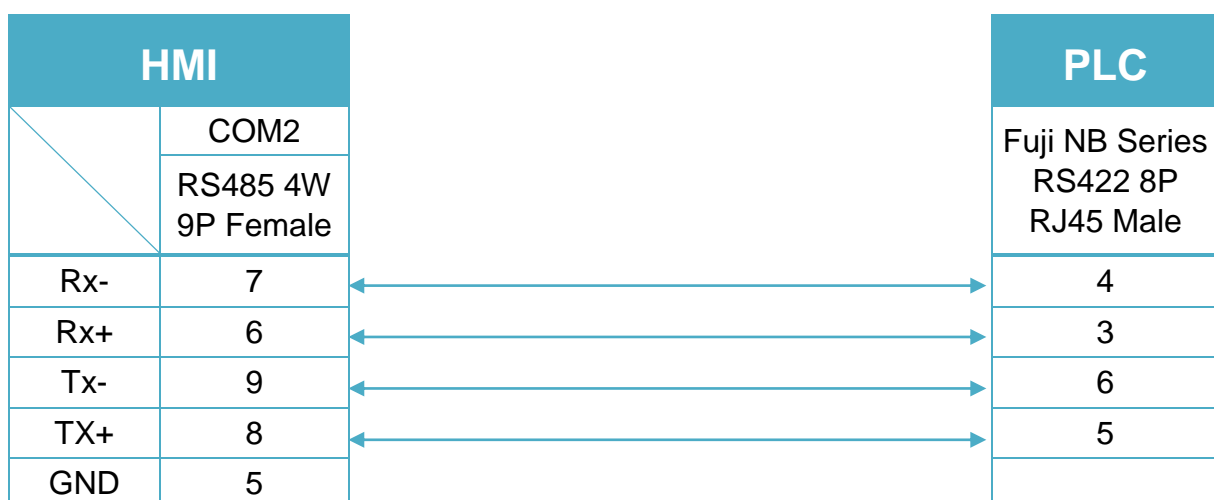


Diagram 3

MT-iE	<i>MT8071iE / MT6071iE / MT8072iE / MT6072iE / MT8073iE / MT8101iE / MT8102iE / MT8103iE</i>
MT-XE	<i>MT8090XE / MT8092XE</i>
MT-iP	<i>MT6071iP / MT8071iP / MT6103iP</i>

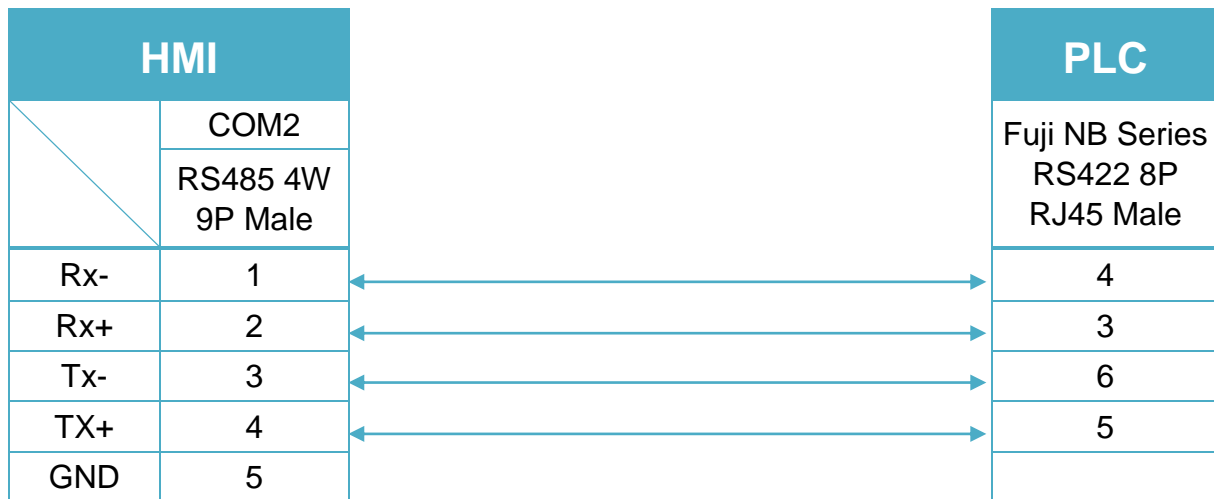
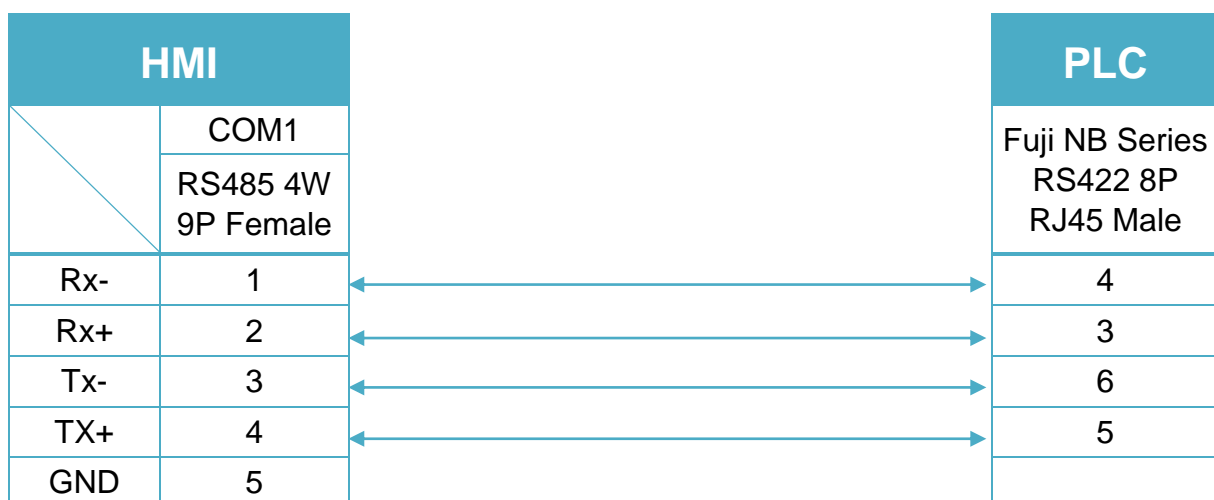


Diagram 4

MT-iE	<i>MT8050iE</i>
MT-iP	<i>MT6051iP</i>



Fuji SPH2000 (Ethernet)

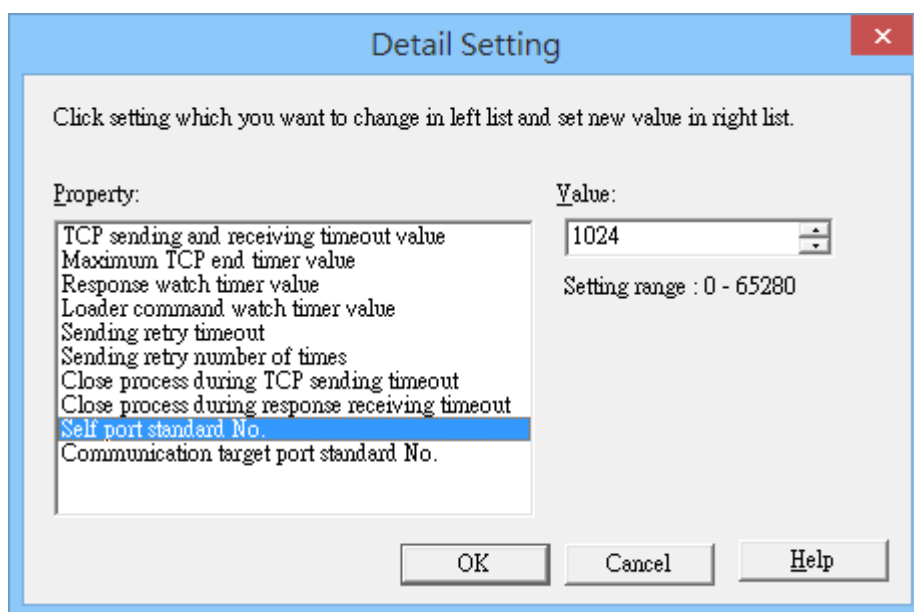
Supported Series: Fuji SPH2000 series PLC.

Website: <http://www.fujielectric.com/fcs/index.html>

HMI Setting:

Parameters	Recommended	Options	Notes
PLC type	Fuji SPH2000 (Ethernet)		
PLC I/F	Ethernet		
Port no.	507	251 ~ 65531	

When setting port number, please add the offset 251. As shown below, the value in the software is 1024, then the port number should be: $1024+251=1275$.



Device Address:

Bit/Word	Device	Format	Range	Memo
B	X	DDDDDDh	10 ~ 238511f	DDD(Slot) / DDD(word) / h(bit)
B	Y	DDDDDDh	10 ~ 238511f	DDD(Slot) / DDD(word) / h(bit)
B	M	DDDDh	0 ~ 8191f	
B	L	DDDDh	0 ~ 4095f	
B	SM	DDDh	0 ~ 511f	
B	S	DD.DD	0 ~ 99.99	
W	WX	DDDDDD	1 ~ 238511	DDD(Slot) / DDD(word)
W	WY	DDDDDD	1 ~ 238511	DDD(Slot) / DDD(word)
W	WM	DDDDD	0 ~ 20000	
DW	DM	DDDDD	0 ~ 20000	
W	WL	DDDDD	0 ~ 20000	
DW	DL	DDDDD	0 ~ 20000	
W	WSM	DDD	0 ~ 511	
DW	DSM	DDD	0 ~ 510	
W	WS	DD	0 ~ 99	
DW	DX	DDDDDD	1000 ~ 238511	DDD(Slot) / DDD(word)
DW	DY	DDDDDD	1000 ~ 238511	DDD(Slot) / DDD(word)

Wiring Diagram:

Diagram 1

Ethernet cable:



GE 90-30 Series (Ethernet)

Supported Series: GE 90-30 series, CPU model 374plus.

HMI Setting:

Parameters	Recommended	Options	Notes
PLC type	GE 90-30 Series (Ethernet)		
PLC I/F	Ethernet		
Port no.	18245		
PLC sta. no.	1	1~99	

Device Address:

Bit/Word	Device type	Format	Range	Memo
B	I_Bit	DDDDD	1 ~ 32768	
B	Q_Bit	DDDDD	1 ~ 32768	
B	M_Bit	DDDDD	1 ~ 32768	
B	G_Bit	DDDDD	1 ~ 32768	
B	T_Bit	DDDDD	1 ~ 32768	
B	SA_Bit	DDDDD	1 ~ 32768	Read Only
B	SB_Bit	DDDDD	1 ~ 32768	Read Only
B	SC_Bit	DDDDD	1 ~ 32768	Read Only
B	S_Bit	DDDDD	1 ~ 32768	Read Only
B	R_Bit	DDDDDdd	100 ~ 3276815	
B	W_Bit	DDDDDDDDdd	100 ~ 500000015	
W	I	DDDDD	1 ~ 32753	Address increment by 8 words, ex: I1, I9, I17, I25.....
W	Q	DDDDD	1 ~ 32753	The rule is same as above, ex:Q1, Q9, Q17...
W	M	DDDDD	1 ~ 32753	The rule is same as above, ex:M1, M9, M17..
W	G	DDDDD	1 ~ 32753	The rule is same as above, ex:G1, G9, G17...
W	T	DDDD	1 ~ 1024	The rule is same as above, ex:T1, T9, T17.....
W	SA	DDDDD	1 ~ 32753	Read only, the rule is same as above
W	SB	DDDDD	1 ~ 32753	Read only, the rule is same as

Bit/Word	Device type	Format	Range	Memo
				above
W	SC	DDDDD	1 ~ 32753	Read only, the rule is same as above
W	S	DDDDD	1 ~ 32753	Read only, the rule is same as above
W	R	DDDDD	1 ~ 32768	
W	AI	DDDDD	1 ~ 32768	
W	AQ	DDDDD	1 ~ 32768	
W	W	DDDDDDD	1 ~ 5000000	

Wiring Diagram:

Diagram 1

Ethernet cable:



GE CMM

Website: <http://www.ge.com>

HMI Setting:

Parameters	Recommended	Options	Notes
PLC type	GE CMM		
PLC I/F	RS232	RS232/RS485	
Baud rate	19200	9600,19200,38400,57600,115200	
Data bits	8	7,8	Must set to 8 for this protocol
Parity	Odd	Even, Odd, None	
Stop bits	1	1, 2	
PLC sta. no.	0	0-255	Does not apply to this protocol

PLC Setting:

Refer to the related PLC manual.

Device Address:

Bit/Word	Device type	Format	Range	Memo
B	I	DDDDD	1 ~ 10000	Input relay
B	Q	DDDDD	1 ~ 10000	Output relay
B	M	DDDDD	1 ~ 10000	Auxiliary relay
B	G	DDDD	1 ~ 7680	
B	T	DDD	1 ~ 256	
B	SA	DDD	1 ~ 128	
B	SB	DDD	1 ~ 128	
B	SC	DDD	1 ~ 128	
B	S	DDD	1 ~ 128	
W	AI	DDDDD	1 ~ 10000	Analog input register
W	AQ	DDDDD	1 ~ 10000	Analog output register
W	R	DDDDD	1 ~ 32640	Data register

Wiring Diagram:

RS485 4W (Diagram 1 ~ Diagram 4)

Diagram 1

cMT Series	cMT3151
eMT Series	eMT3070 / eMT3105 / eMT3120 / eMT3150
MT-iE	MT8070iE / MT6070iE / MT8100iE / MT8121iE / MT8150iE
MT-XE	MT8121XE / MT8150XE

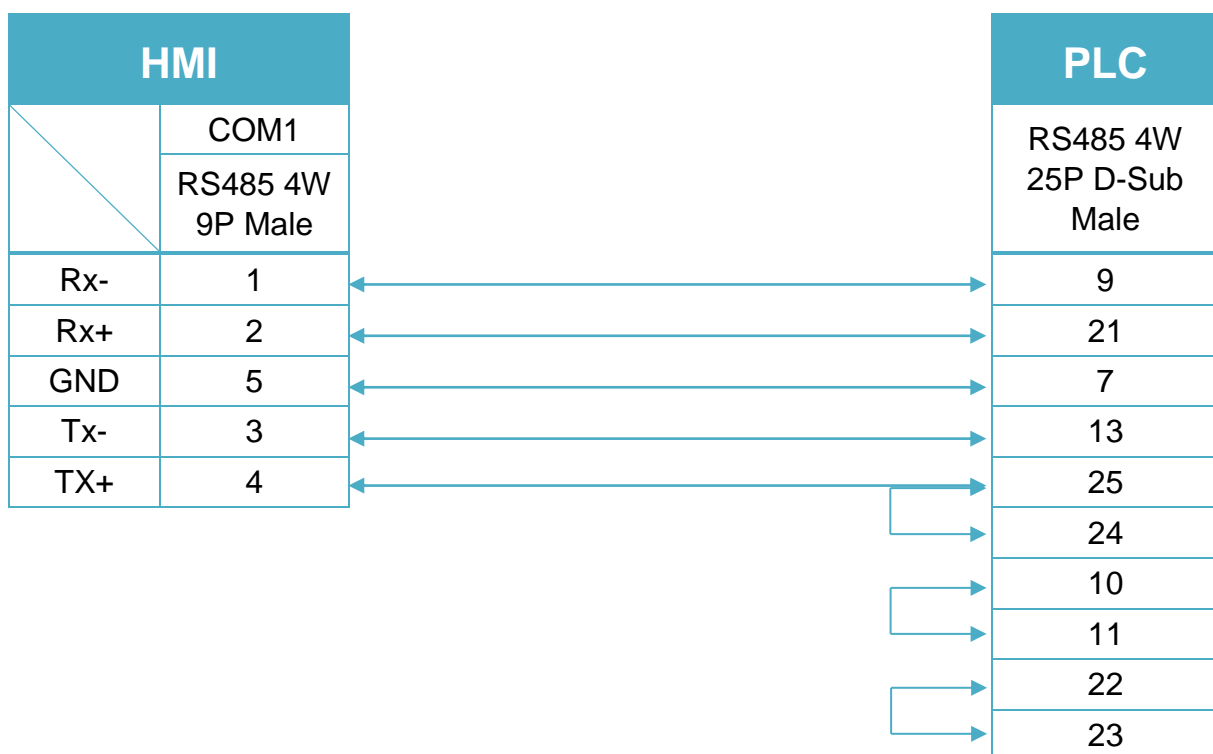


Diagram 2

cMT Series *cMT-SVR*

mTV *mTV*

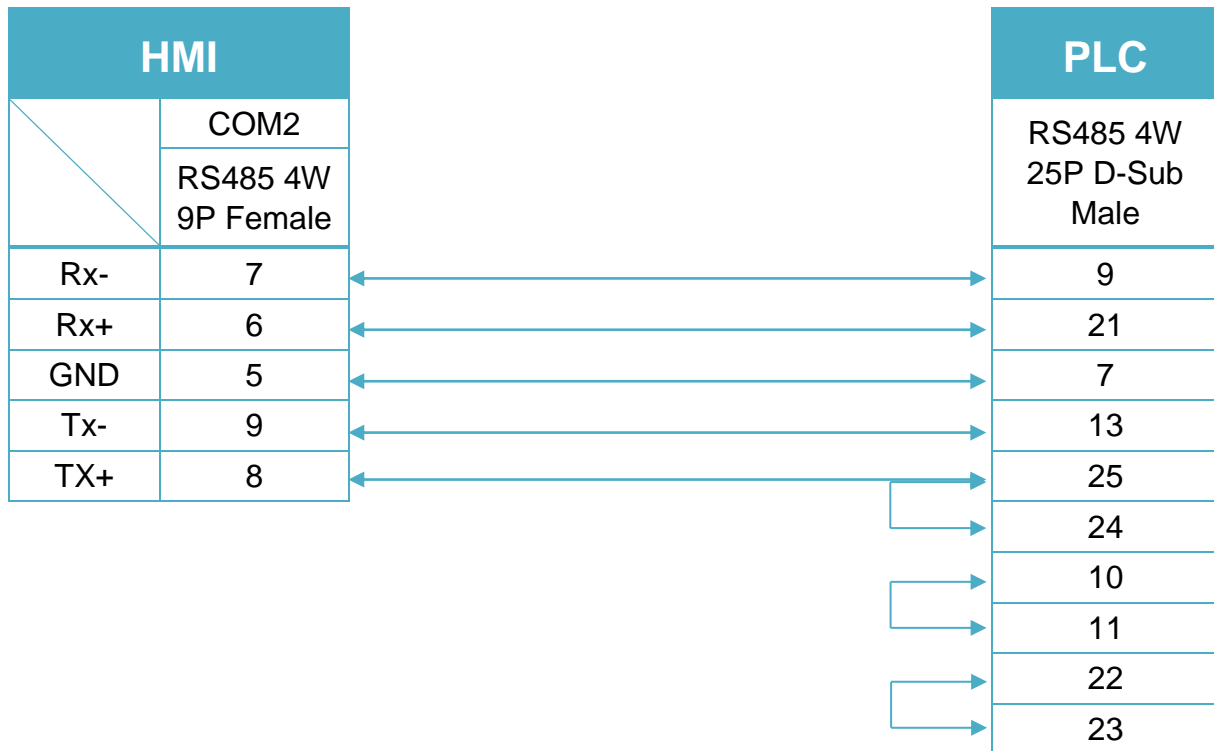


Diagram 3

MT-iE	<i>MT8071iE / MT6071iE / MT8072iE / MT6072iE / MT8073iE / MT8101iE / MT8102iE / MT8103iE</i>
MT-XE	<i>MT8090XE / MT8092XE</i>
MT-iP	<i>MT6071iP / MT8071iP / MT6103iP</i>

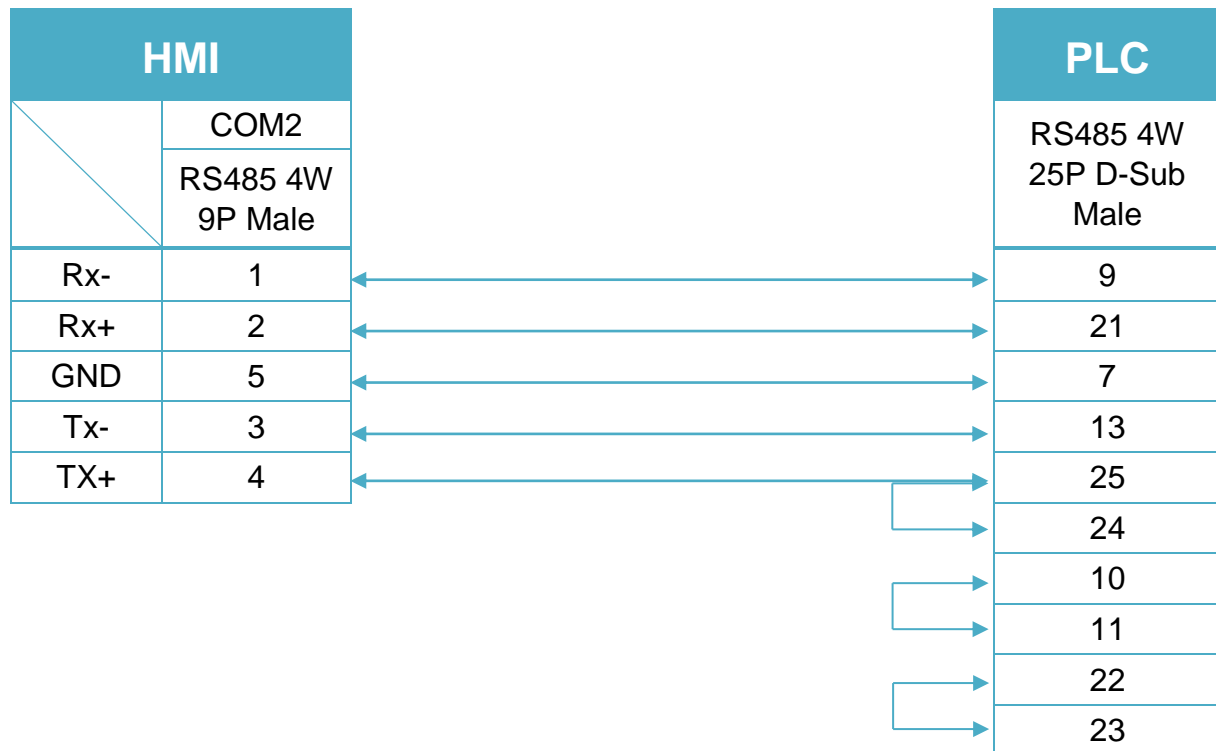
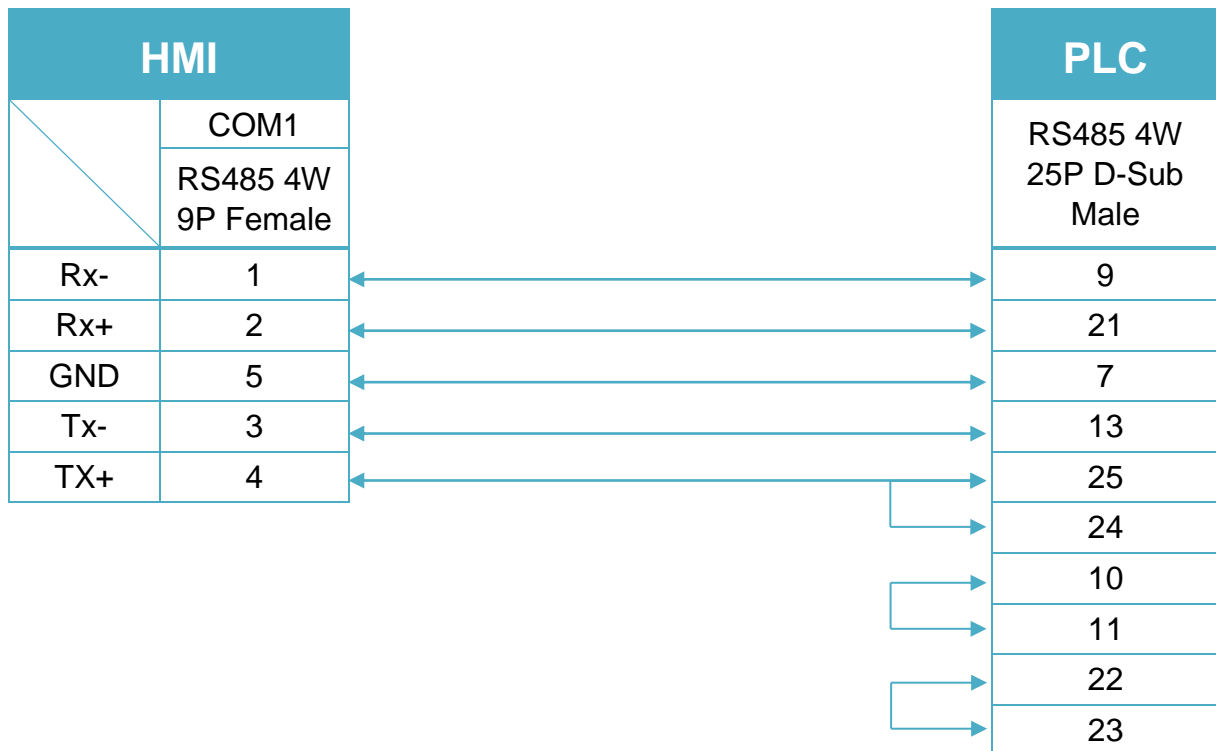


Diagram 4
MT-iE *MT8050iE*
MT-iP *MT6051iP*


RS232 (Diagram 5 ~ Diagram 7)

Diagram 5

cMT Series	<i>cMT3151</i>
eMT Series	<i>eMT3070 / eMT3105 / eMT3120 / eMT3150</i>
MT-iE	<i>MT8073iE / MT8102iE</i>
MT-XE	<i>MT8092XE</i>
MT-iP	<i>MT6103iP</i>

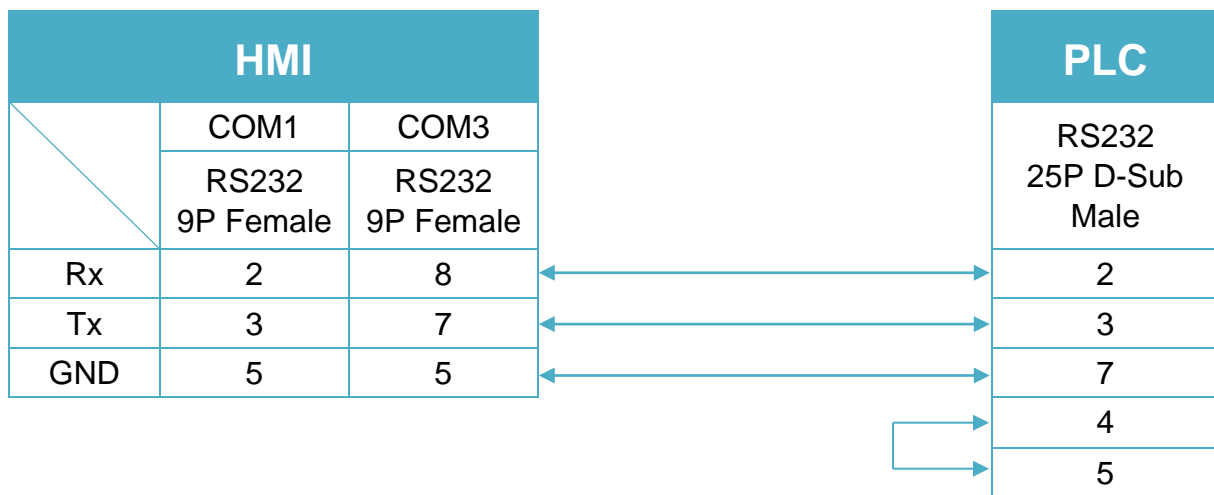


Diagram 6

cMT Series	cMT-SVR
mTV	mTV
MT-iE	MT8070iE / MT6070iE / MT8100iE / MT8121iE / MT8150iE / MT8071iE / MT6071iE / MT8072iE / MT6072iE / MT8073iE / MT8101iE / MT8102iE / MT8103iE
MT-XE	MT8121XE / MT8150XE / MT8090XE

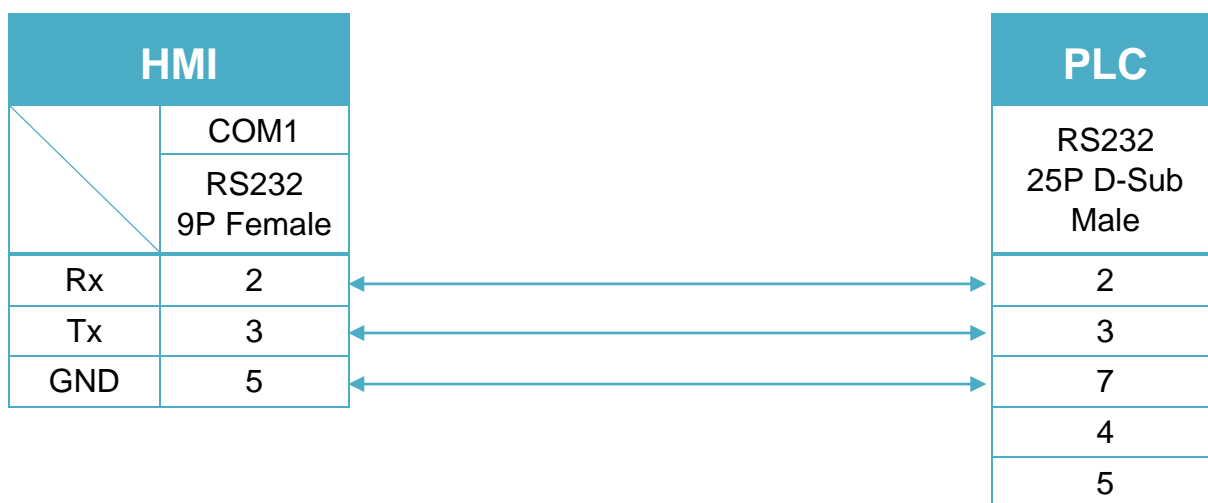
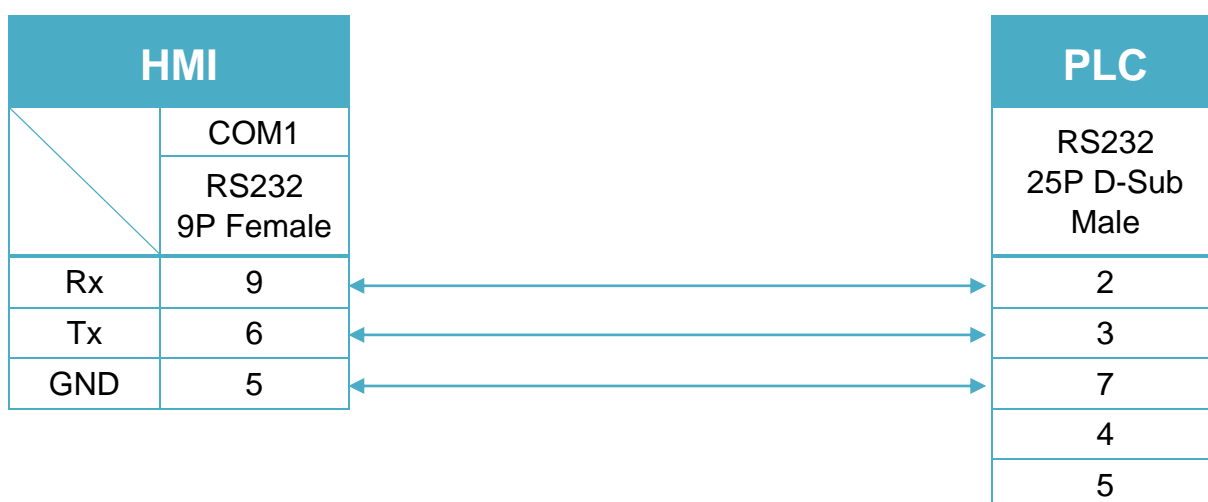


Diagram 7

MT-iE	MT8050iE
MT-iP	MT6051iP / MT6071iP / MT8071iP



GE RX3i

Website: <http://www.ge.com>

HMI Setting:

Parameters	Recommended	Options	Notes
PLC type	GE RX3i		
PLC I/F	RS232	RS232, RS485	
Baud rate	19200	1200~115200	
Data bits	8		
Parity	Odd	None, Even, Odd	
Stop bits	1	1 or 2	
SNP ID	1	0~255 (None)	

PLC Setting:

Port Mode	SNP Slave
-----------	-----------

Device Address:

Bit/Word	Device type	Format	Range	Memo
B	I	DDDDD	1 ~ 32768	
B	Q	DDDDD	1 ~ 32768	
B	M	DDDDD	1 ~ 32768	
B	G	DDDDD	1 ~ 32768	
B	T	DDDDD	1 ~ 32768	
B	SA	DDDDD	1 ~ 32768	
B	SB	DDDDD	1 ~ 32768	
B	SC	DDDDD	1 ~ 32768	
B	S	DDDDD	1 ~ 32768	
W	AI	DDDDD	1 ~ 32768	
W	AQ	DDDDD	1 ~ 32768	
W	R	DDDDD	1 ~ 32768	

Wiring Diagram:

GE Fanuc RX3i COM1 (Diagram 1 ~ Diagram 3)

Diagram 1

cMT Series	<i>cMT3151</i>
eMT Series	<i>eMT3070 / eMT3105 / eMT3120 / eMT3150</i>
MT-iE	<i>MT8073iE / MT8102iE</i>
MT-XE	<i>MT8092XE</i>
MT-iP	<i>MT6103iP</i>

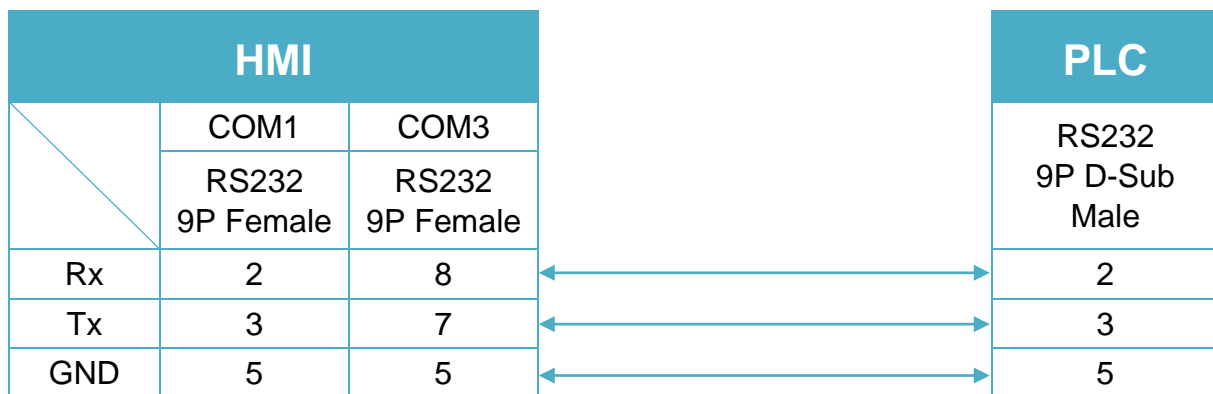
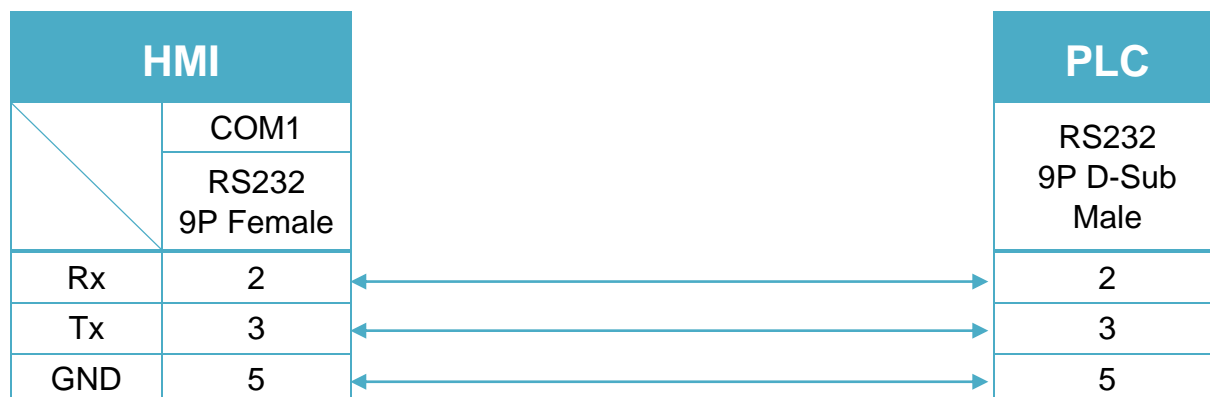


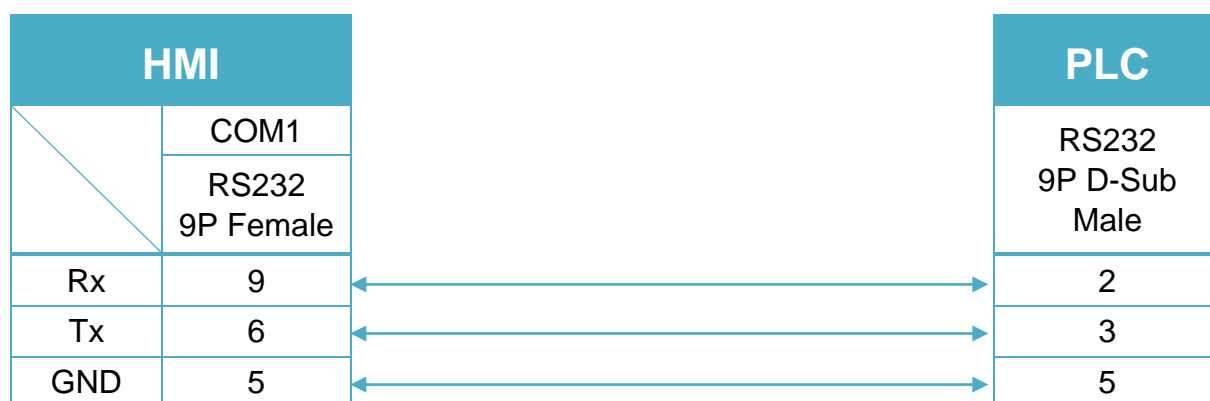
Diagram 2

cMT Series	<i>cMT-SVR</i>
mTV	<i>mTV</i>
MT-iE	<i>MT8070iE / MT6070iE / MT8100iE / MT8121iE / MT8150iE / MT8071iE / MT6071iE / MT8072iE / MT6072iE / MT8073iE / MT8101iE / MT8102iE / MT8103iE</i>
MT-XE	<i>MT8121XE / MT8150XE / MT8090XE</i>


Diagram 3

MT-iE *MT8050iE*

MT-iP *MT6051iP / MT6071iP / MT8071iP*



GE Fanuc RX3i COM2 RS485 4W (Diagram 4 ~ Diagram 7)

Diagram 4

cMT Series *cMT3151*

eMT Series *eMT3070/ eMT3105 / eMT3120 / eMT3150*

MT-iE *MT8070iE / MT6070iE / MT8100iE / MT8121iE / MT8150iE*

MT-XE *MT8121XE / MT8150XE*

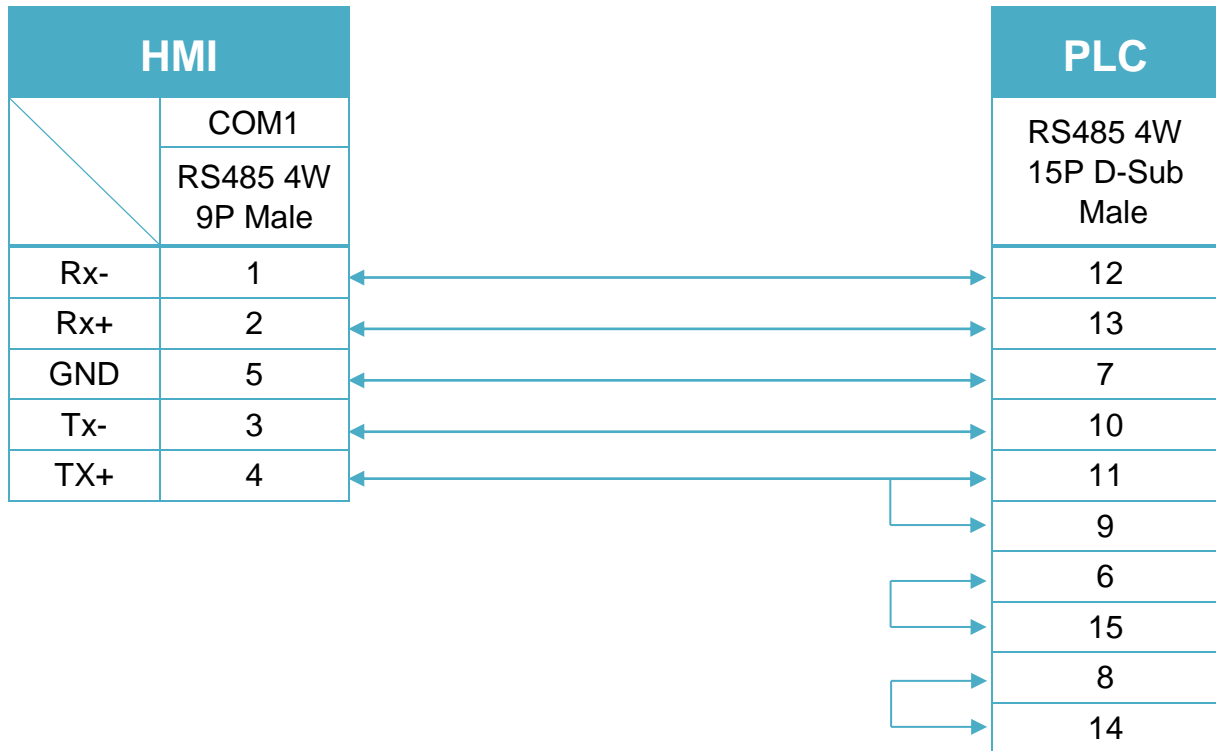
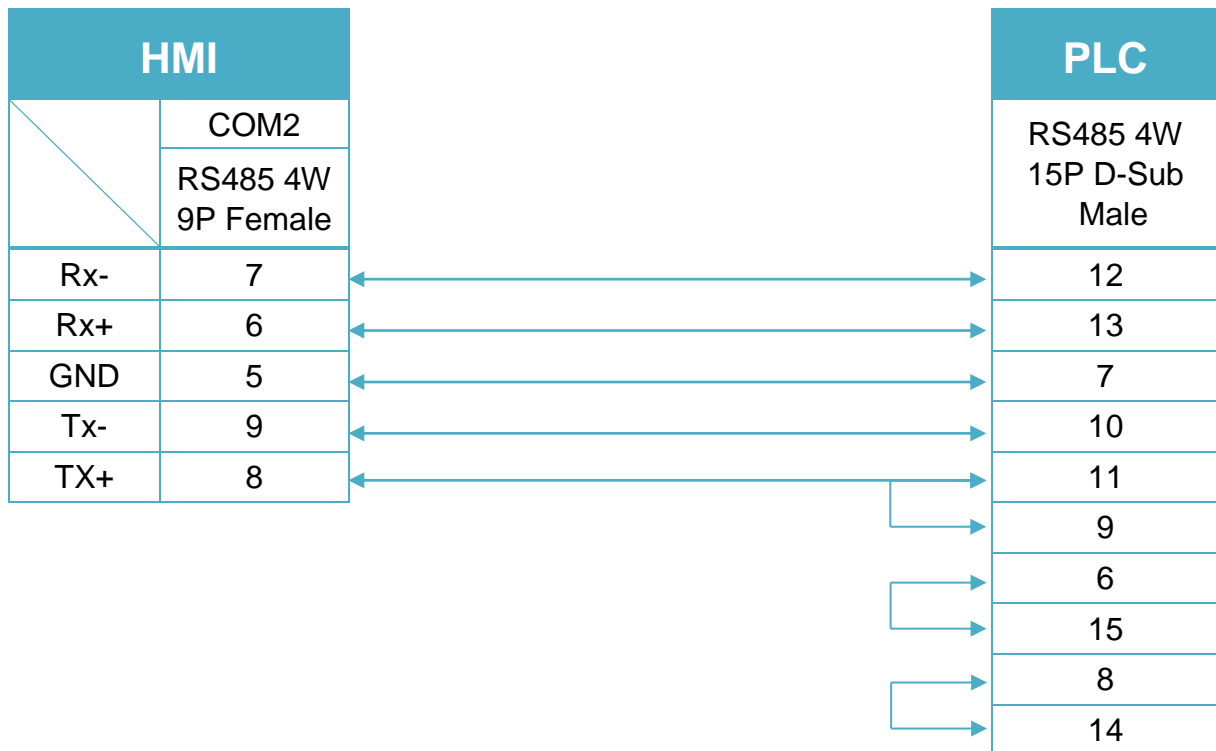

Diagram 5
cMT Series
cMT-SVR
mTV
mTV


Diagram 6

MT-iE	<i>MT8071iE / MT6071iE / MT8072iE / MT6072iE / MT8073iE / MT8101iE / MT8102iE / MT8103iE</i>
MT-XE	<i>MT8090XE / MT8092XE</i>
MT-iP	<i>MT6071iP / MT8071iP / MT6103iP</i>

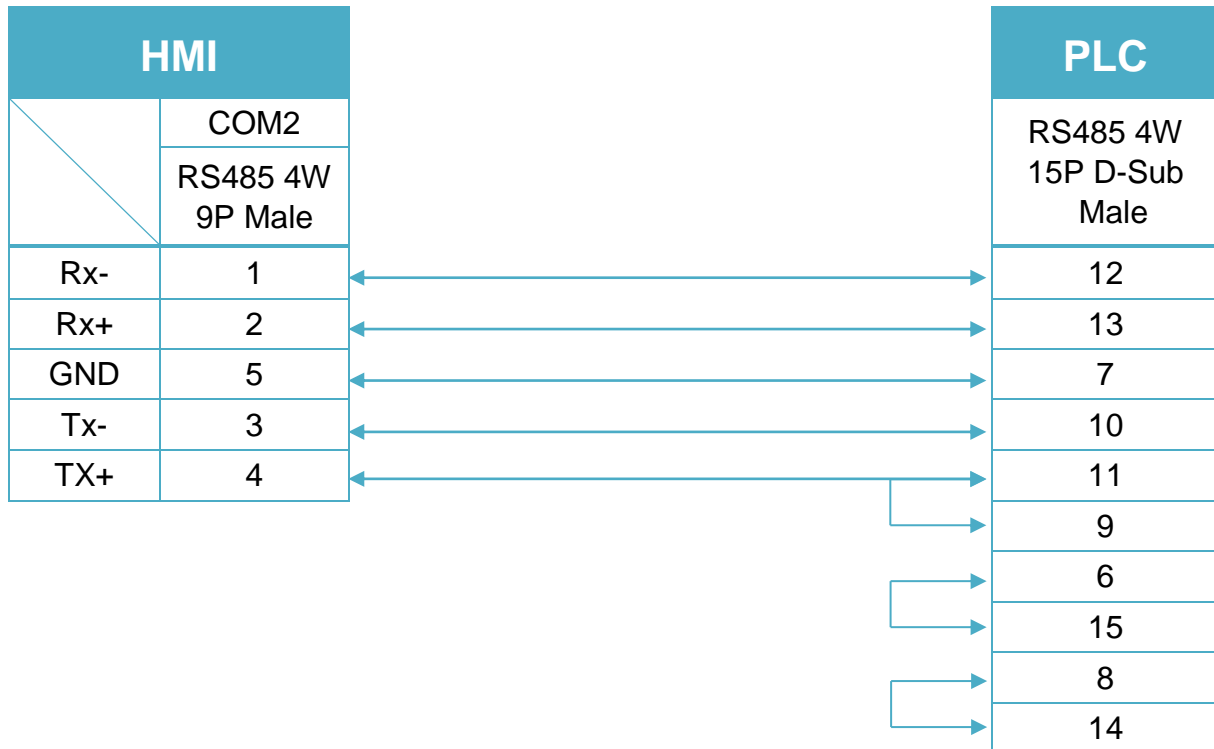
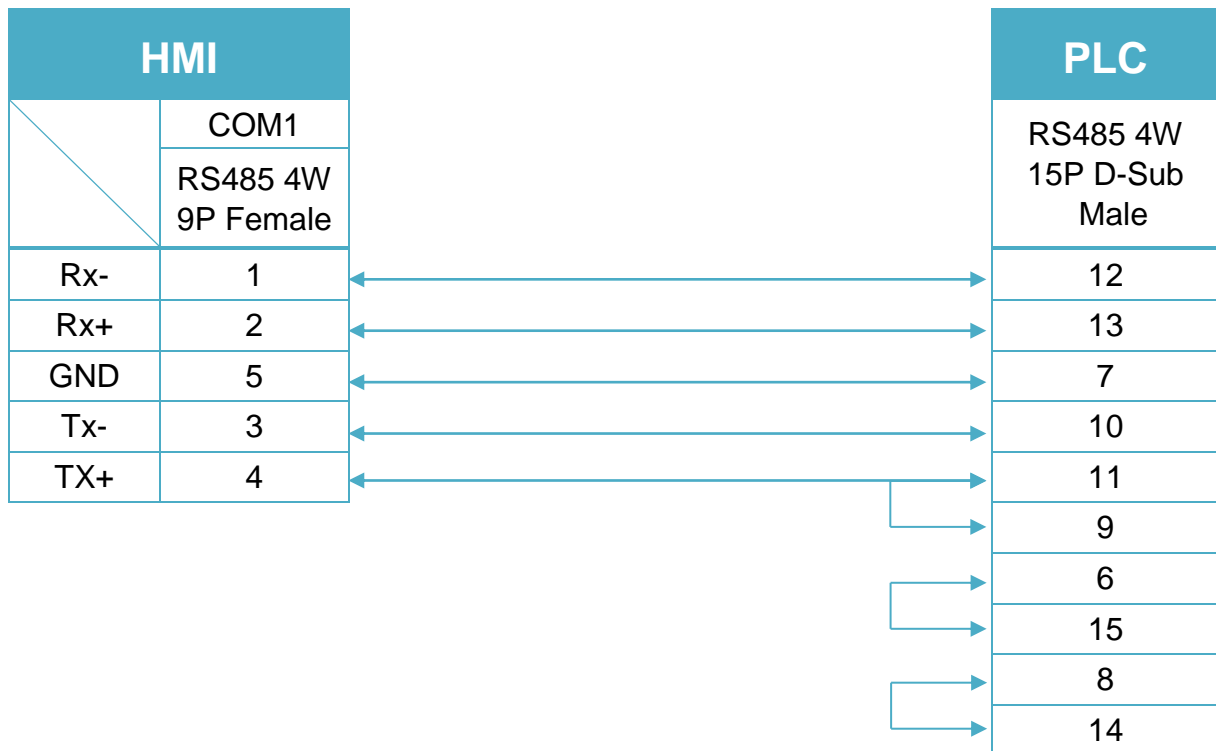


Diagram 7
MT-iE *MT8050iE*
MT-iP *MT6051iP*


GE RX3i (Ethernet)

Website: <http://www.ge.com>

HMI Setting:

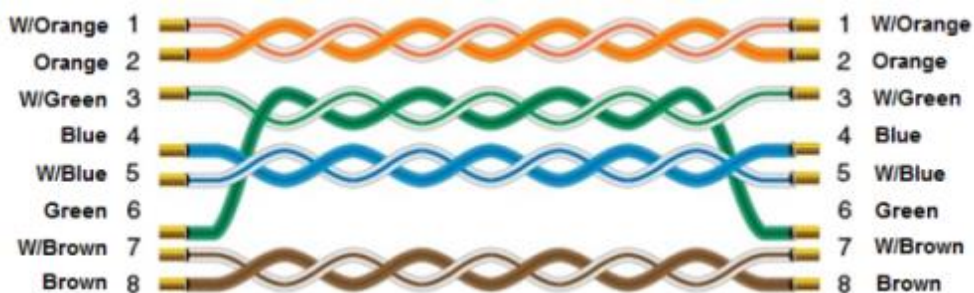
Parameters	Recommended	Options	Notes
PLC type	GE RX3i (Ethernet)		
PLC I/F	Ethernet		
Port no.	18245		

Device Address:

Bit/Word	Device type	Format	Range	Memo
B	I	DDDDD	1 ~ 32768	
B	Q	DDDDD	1 ~ 32768	
B	M	DDDDD	1 ~ 32768	
B	G	DDDD	1 ~ 7680	
B	T	DDDD	1 ~ 1024	
B	SA	DDD	1 ~ 128	
B	SB	DDD	1 ~ 128	
B	SC	DDD	1 ~ 128	
B	S	DDD	1 ~ 128	
W	AI	DDDDD	1 ~ 32640	
W	AQ	DDDDD	1 ~ 32640	
W	R	DDDDD	1 ~ 32640	

Wiring Diagram:

Ethernet cable:



GE SNP-X

Supported Series: GE 90-30 , 90 micro and VersaMax series PLC , 90-70 series with CMM711 module.

Website: <http://www.ge.com>

HMI Setting:

Parameters	Recommended	Options	Notes
PLC type	GE SNP-X		
PLC I/F	RS485 4W	RS232/RS485	
Baud rate	19200	9600 ~ 115200	
Data bits	8	7, 8	Must set to 8 for this protocol
Parity	Odd	Even, Odd, None	
Stop bits	1	1, 2	
PLC sta. no.	0	0-255	Does not apply to this protocol

PLC Setting:

Refer to the related PLC manual.

Device Address:

Bit/Word	Device	Format	Range	Memo
B	I	DDDDD	1 ~ 10000	Input relay
B	Q	DDDDD	1 ~ 10000	Output relay
B	M	DDDDD	1 ~ 10000	Auxiliary relay
B	G	DDDD	1 ~ 7680	
B	T	DDD	1 ~ 256	
B	SA	DDD	1 ~ 128	
B	SB	DDD	1 ~ 128	
B	SC	DDD	1 ~ 128	
B	S	DDD	1 ~ 128	
B	R_bit	DDDDDdd	100 ~ 3264015	Data register bit
W	AI	DDDDD	1 ~ 10000	Analog input register
W	AQ	DDDDD	1 ~ 10000	Analog output register
W	R	DDDDD	1 ~ 32640	Data register

Wiring Diagram:

CPU Port 90-30/VersaMax (Diagram 1 ~ Diagram 4)

Diagram 1

cMT Series	<i>cMT3151</i>
eMT Series	<i>eMT3070 / eMT3105 / eMT3120 / eMT3150</i>
MT-iE	<i>MT8070iE / MT6070iE / MT8100iE / MT8121iE / MT8150iE</i>
MT-XE	<i>MT8121XE / MT8150XE</i>

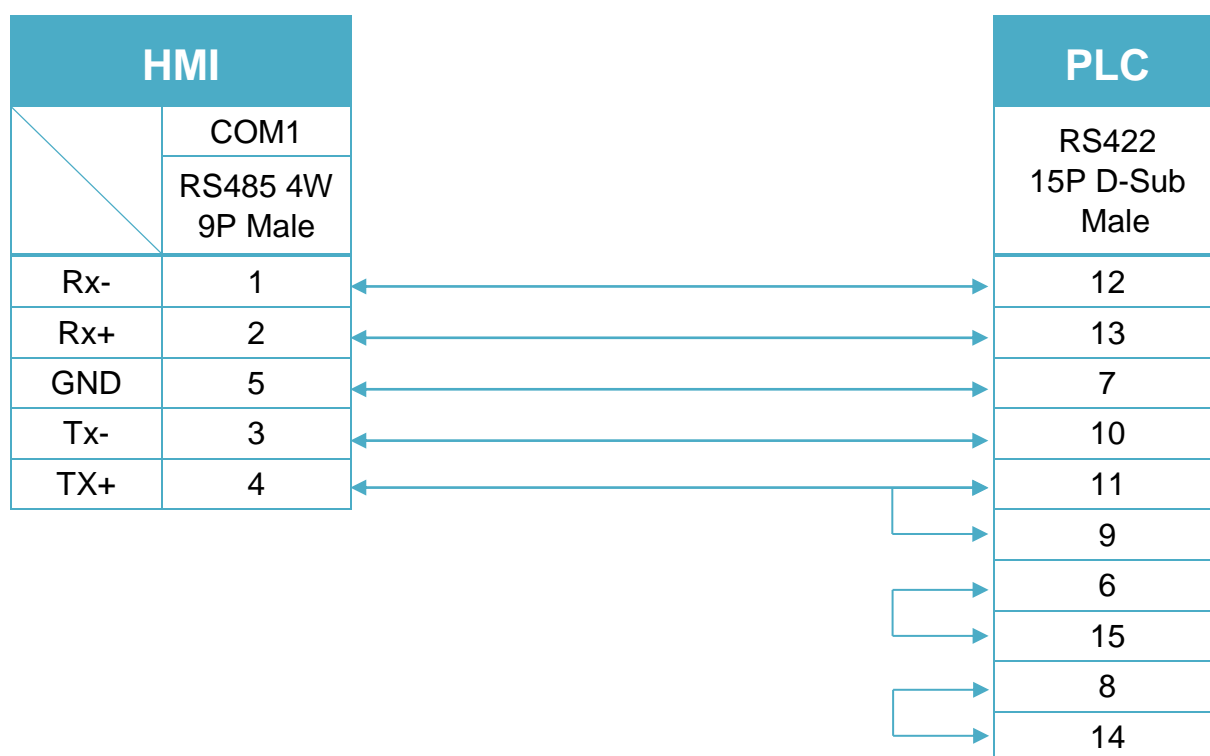


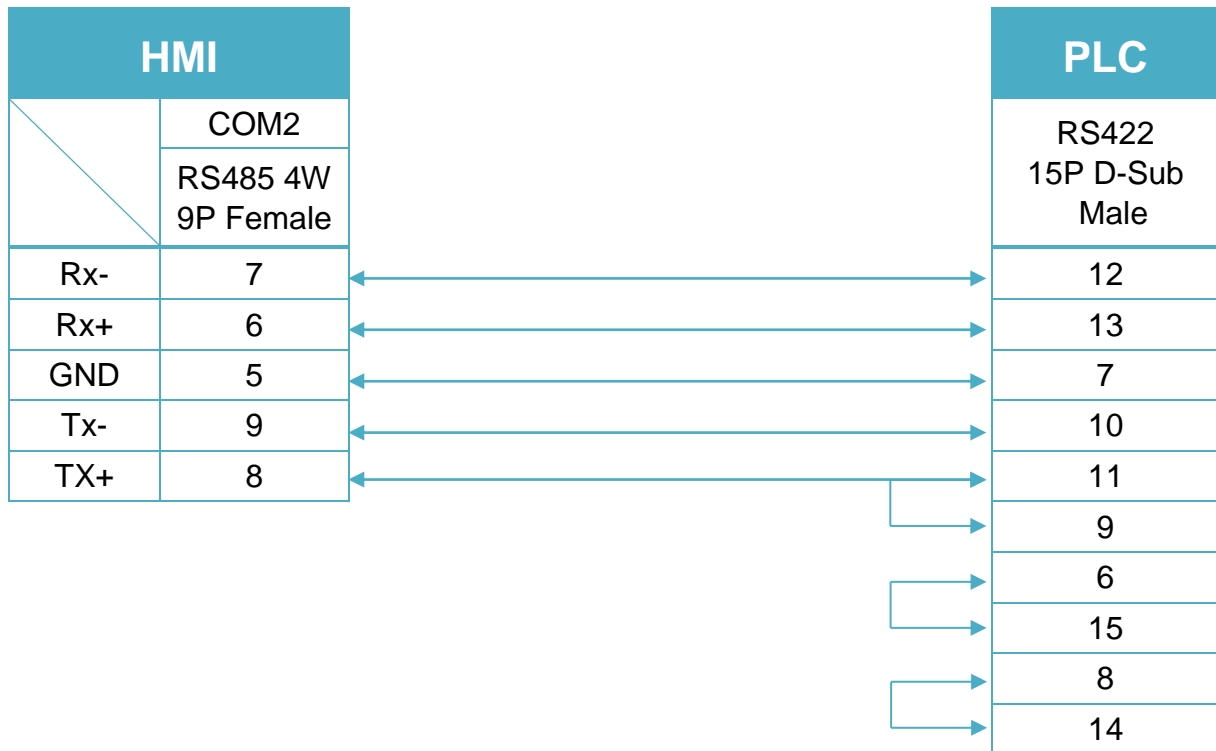
Diagram 2
cMT Series
cMT-SVR
mTV
mTV


Diagram 3

MT-iE	<i>MT8071iE / MT6071iE / MT8072iE / MT6072iE / MT8073iE / MT8101iE / MT8102iE / MT8103iE</i>
MT-XE	<i>MT8090XE / MT8092XE</i>
MT-iP	<i>MT6071iP / MT8071iP / MT6103iP</i>

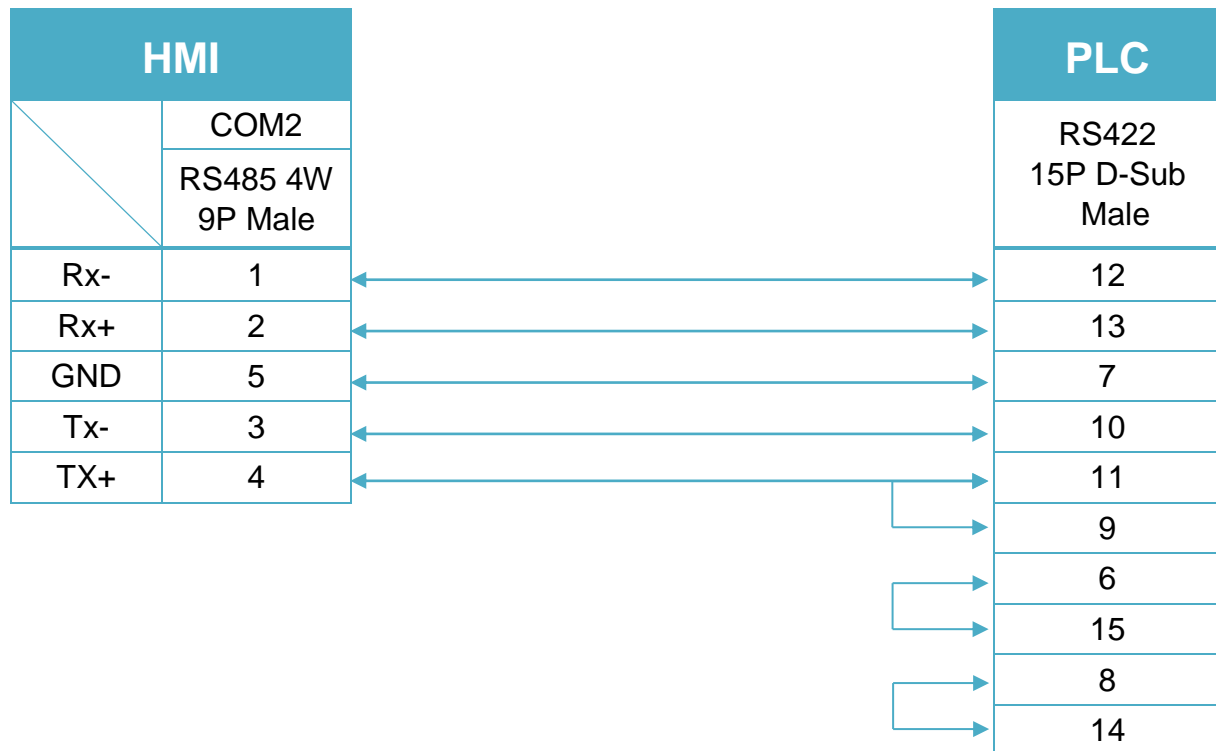
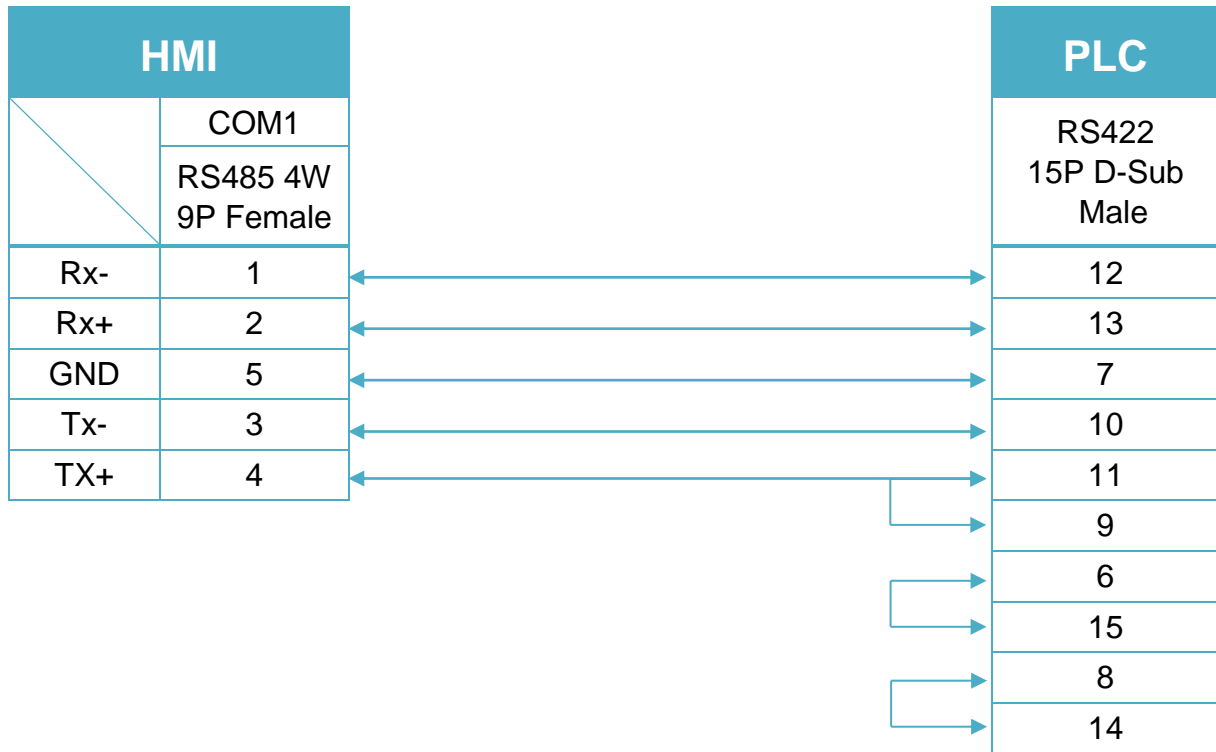


Diagram 4
MT-iE *MT8050iE*
MT-iP *MT6051iP*


CPU Port (90-30 series CPU351/352/363/364) (Diagram 5 ~ Diagram 7)

Diagram 5

cMT Series	<i>cMT3151</i>
eMT Series	<i>eMT3070 / eMT3105 / eMT3120 / eMT3150</i>
MT-iE	<i>MT8073iE / MT8102iE</i>
MT-XE	<i>MT8092XE</i>
MT-iP	<i>MT6103iP</i>

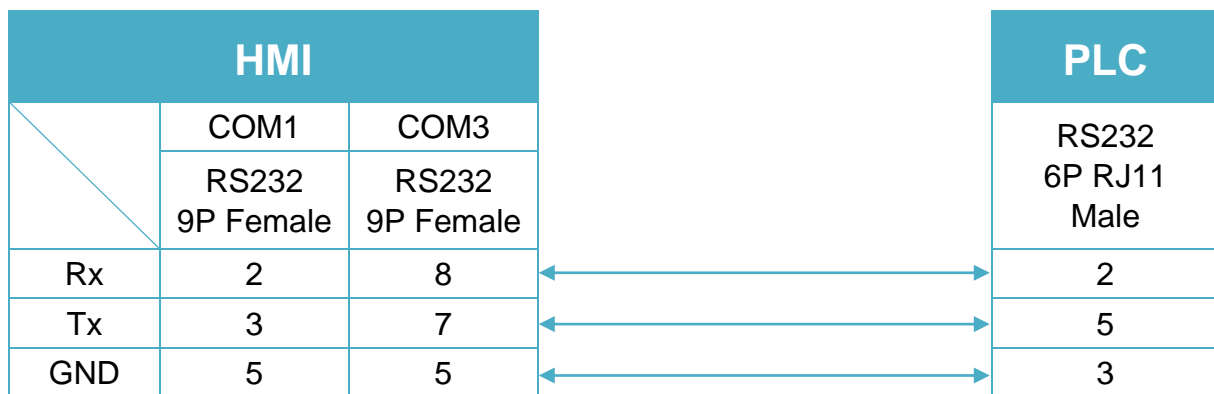


Diagram 6

cMT Series	cMT-SVR
mTV	mTV
MT-iE	MT8070iE / MT6070iE / MT8100iE / MT8121iE / MT8150iE / MT8071iE / MT6071iE / MT8072iE / MT6072iE / MT8073iE / MT8101iE / MT8102iE / MT8103iE
MT-XE	MT8121XE / MT8150XE / MT8090XE

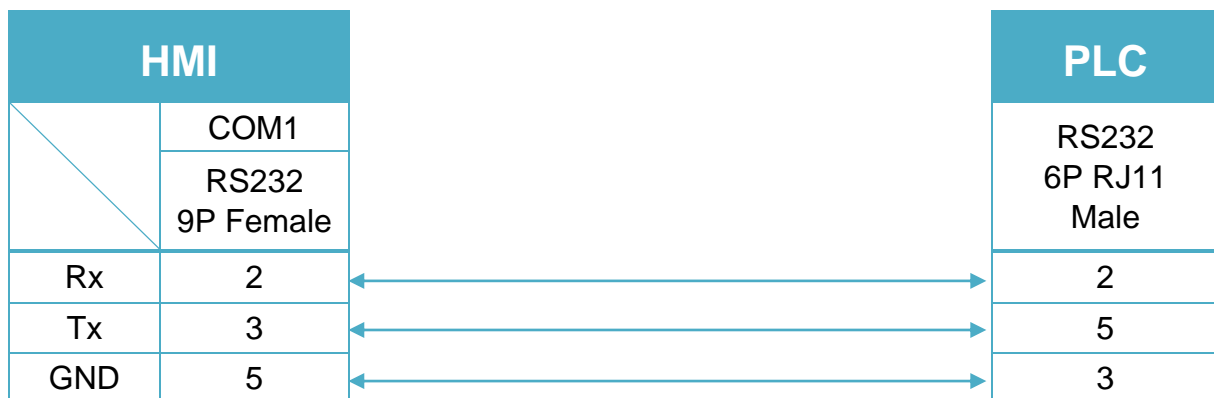


Diagram 7

MT-iE	MT8050iE
MT-iP	MT6051iP / MT6071iP / MT8071iP



CPU Port (VersaMax series CPU001/002/005/E05) (Diagram 8 ~ Diagram 10)

Diagram 8

cMT Series	<i>cMT3151</i>
eMT Series	<i>eMT3070 / eMT3105 / eMT3120 / eMT3150</i>
MT-iE	<i>MT8073iE / MT8102iE</i>
MT-XE	<i>MT8092XE</i>
MT-iP	<i>MT6103iP</i>

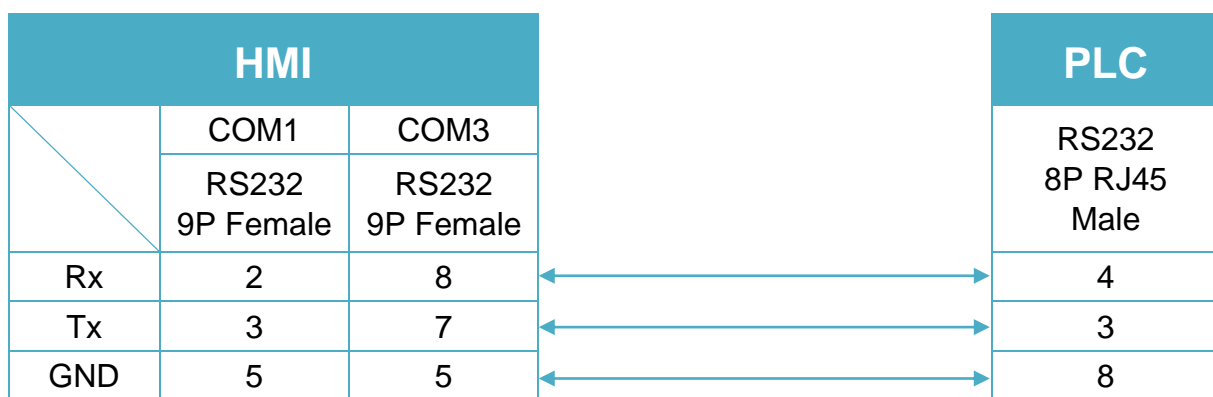


Diagram 9

cMT Series	<i>cMT-SVR</i>
mTV	<i>mTV</i>
MT-iE	<i>MT8070iE / MT6070iE / MT8100iE / MT8121iE / MT8150iE / MT8071iE / MT6071iE / MT8072iE / MT6072iE / MT8073iE / MT8101iE / MT8102iE / MT8103iE</i>
MT-XE	<i>MT8121XE / MT8150XE / MT8090XE</i>

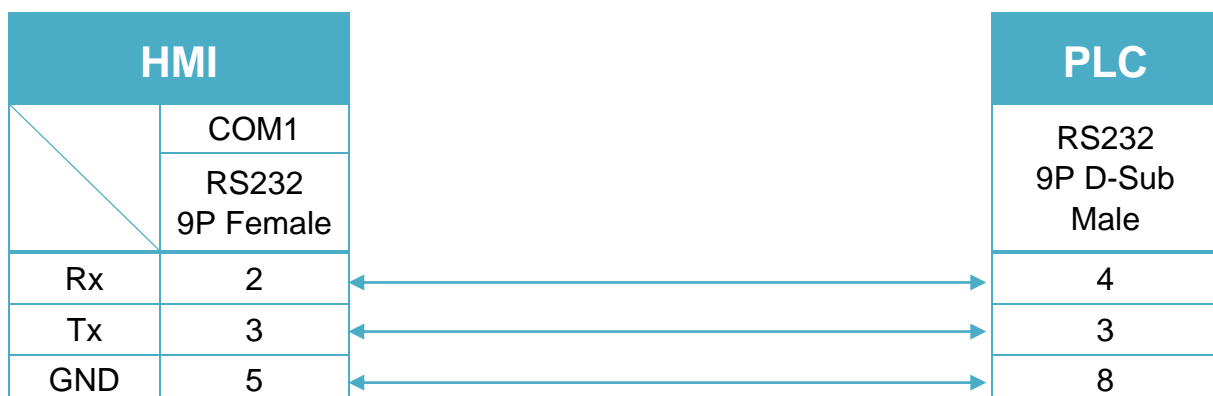
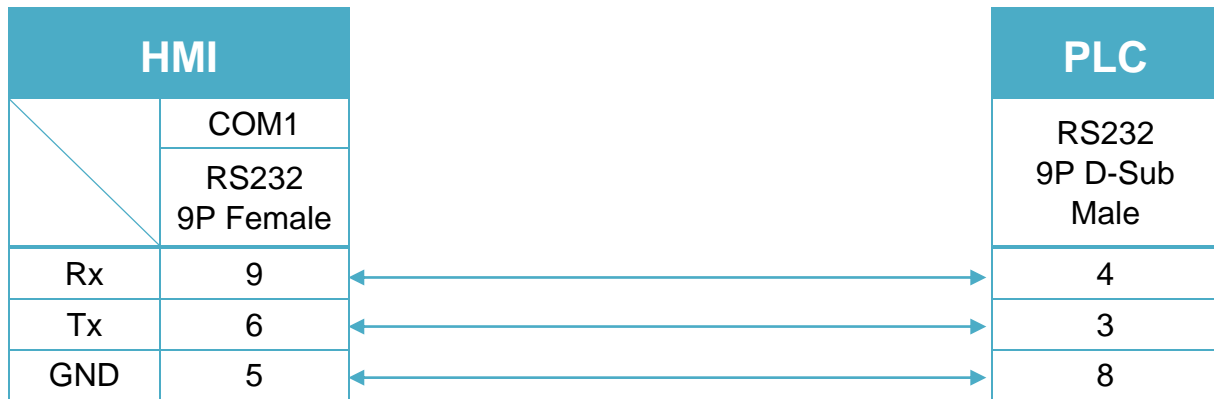


Diagram 10

MT-iE
MT8050iE
MT-iP
MT6051iP / MT6071iP / MT8071iP


GE VersaMax (Ethernet)

Supported Series: GE Fanuc VersaMax controllers

Website: <http://www.ge.com>

HMI Setting:

Parameters	Recommended	Options	Notes
PLC type	GE VersaMax (Ethernet)		
PLC I/F	Ethernet		
Port no.	18245		

Device Address:

Bit/Word	Device type	Format	Range	Memo
B	I	DDDDD	1 ~ 32768	
B	Q	DDDDD	1 ~ 32768	
B	M	DDDDD	1 ~ 32768	
B	G	DDDDD	1 ~ 7680	
B	T	DDDDD	1 ~ 1024	
B	SA	DDDDD	1 ~ 128	
B	SB	DDDDD	1 ~ 128	
B	SC	DDDDD	1 ~ 128	
B	S	DDDDD	1 ~ 128	
W	AI	DDDDD	1 ~ 32640	
W	AQ	DDDDD	1 ~ 32640	
W	R	DDDDD	1 ~ 32640	
W	IW	DDDD	1 ~ 2048	
W	QW	DDDD	1 ~ 2048	
W	MW	DDDD	1 ~ 2048	
W	GW	DDD	1 ~ 480	
W	TW	DD	1 ~ 64	
W	SW	D	1 ~ 8	

Wiring Diagram:

Diagram 1

Ethernet cable:



Haiwell PLC

Support Series: Haiwell C series, T Series, H Series, N Series, S Series PLC

Web: <http://www.haiwell.com/>

HMI Setting:

Parameters	Recommended	Options	Notes
PLC type	Haiwell PLC		
PLC I/F	RS232	RS232,RS485 2W	
Baud rate	19200	19200	
Data bits	8	8	
Parity	None	None	
Stop bits	2	2	
PLC sta. no.	1	1~247	

Device Address:

Bit/Word	Device type	Format	Range	Memo
B	X	DDDD	0 ~ 1023	Input Switch
B	Y	DDDD	0 ~ 1023	Output Switch
B	M	DDDDD	0 ~ 12287	Internal Relay
B	T	DDDD	0 ~ 1023	Timer (Output Coil State)
B	C	DDD	0 ~ 255	Timer (Output Coil State)
B	SM	DDD	0 ~ 215	System Status Bit
B	S	DDDD	0 ~ 2047	Step Bit
W	CR	DD	0 ~ 79	Special Module Parameter Register
W	AI	DDD	0 ~ 255	Analog Input Register
W	AQ	DDD	0 ~ 255	Analog Output Register
W	V	DDDDD	0 ~ 14847	Data Register
W	TCV	DDDD	0 ~ 1023	Timer (current value register)
W	CCV	DDD	0 ~ 255	Timer (current value register)
W	SV	DDD	0 ~ 154	System Register

Wiring Diagram:

The following is the view from the soldering point of a connector.



RS232 4P Mini-Din (Diagram 1 ~ Diagram3)

Diagram 1

cMT Series	<i>cMT3151</i>
eMT Series	<i>eMT3070 / eMT3105 / eMT3120 / eMT3150</i>
MT-iE	<i>MT8073iE / MT8102iE</i>
MT-XE	<i>MT8092XE</i>
MT-iP	<i>MT6103iP</i>

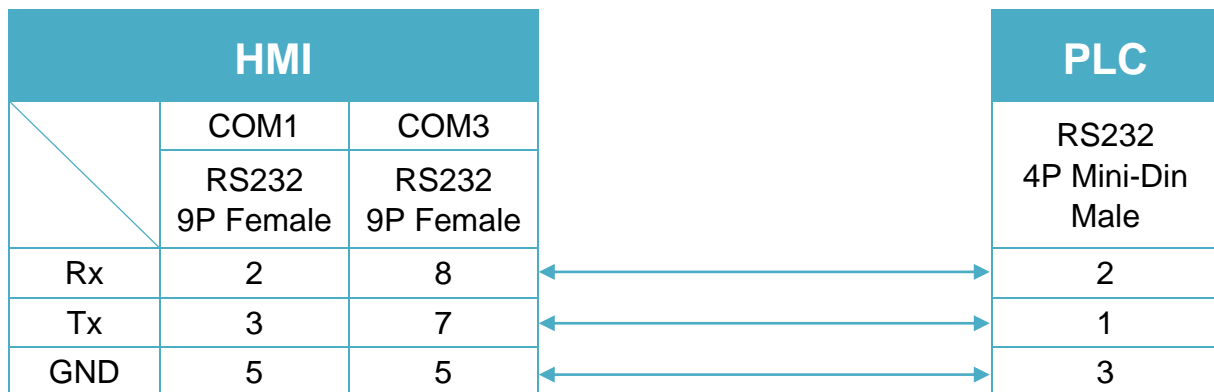


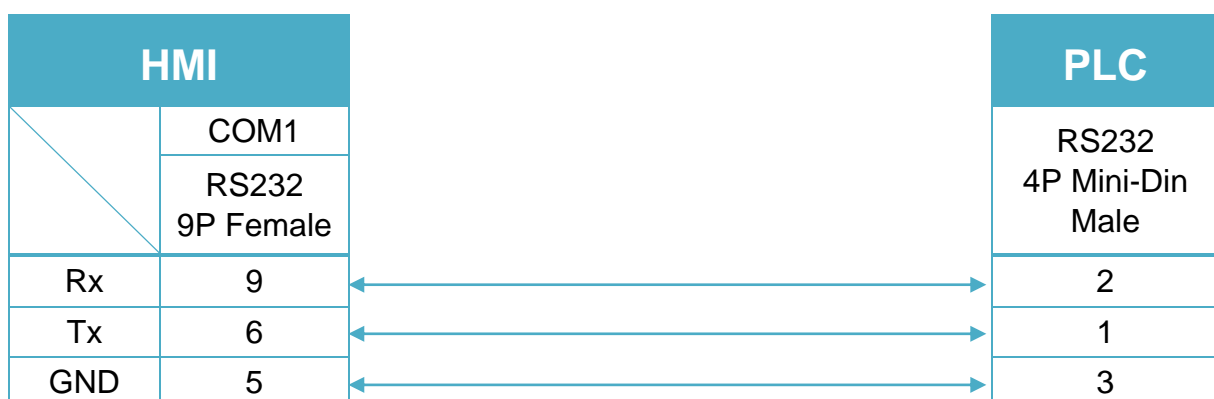
Diagram 2

cMT Series	cMT-SVR
mTV	mTV
MT-iE	MT8070iE / MT6070iE / MT8100iE / MT8121iE / MT8150iE / MT8071iE / MT6071iE / MT8072iE / MT6072iE / MT8073iE / MT8101iE / MT8102iE / MT8103iE
MT-XE	MT8121XE / MT8150XE / MT8090XE



Diagram 3

MT-iE	MT8050iE
MT-iP	MT6051iP / MT6071iP / MT8071iP



RS485 2W Terminal (Diagram 4 ~ Diagram9)

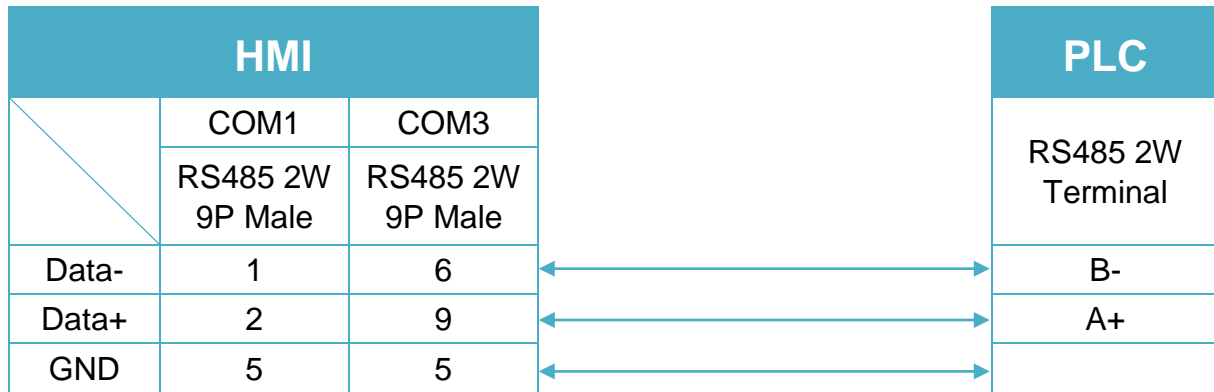
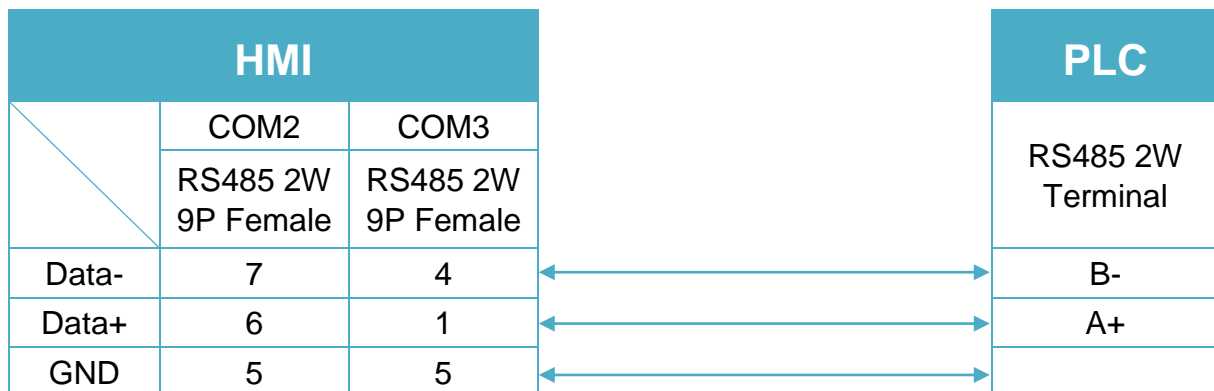
Diagram 4
cMT Series
cMT3151
eMT Series
eMT3070 / eMT3105 / eMT3120 / eMT3150

Diagram 5
cMT Series
cMT-SVR
mTV
mTV


Diagram 6

MT-iE *MT8070iE / MT6070iE / MT8100iE / MT8121iE / MT8150iE*

MT-XE *MT8121XE / MT8150XE*

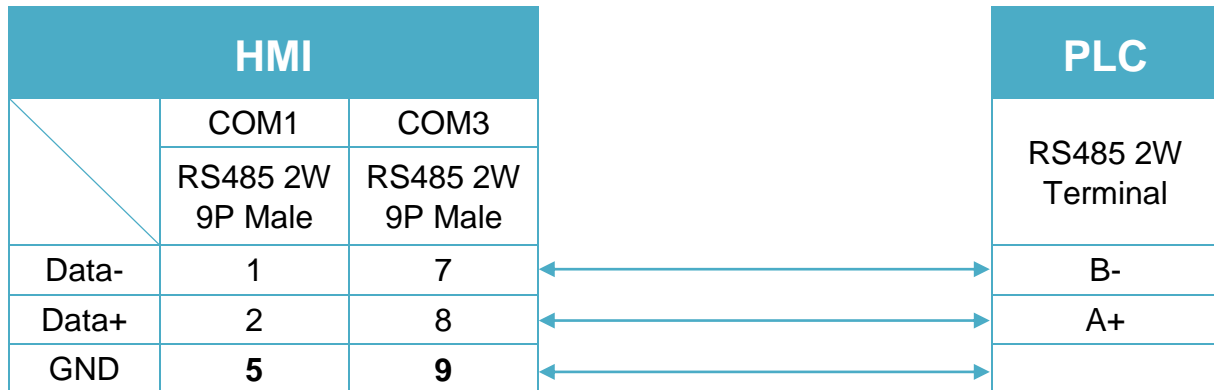


Diagram 7

MT-iE *MT8071iE / MT6071iE / MT8072iE / MT6072iE / MT8073iE / MT8101iE / MT8102iE / MT8103iE*

MT-XE *MT8090XE / MT8092XE*

MT-iP *MT6103iP*

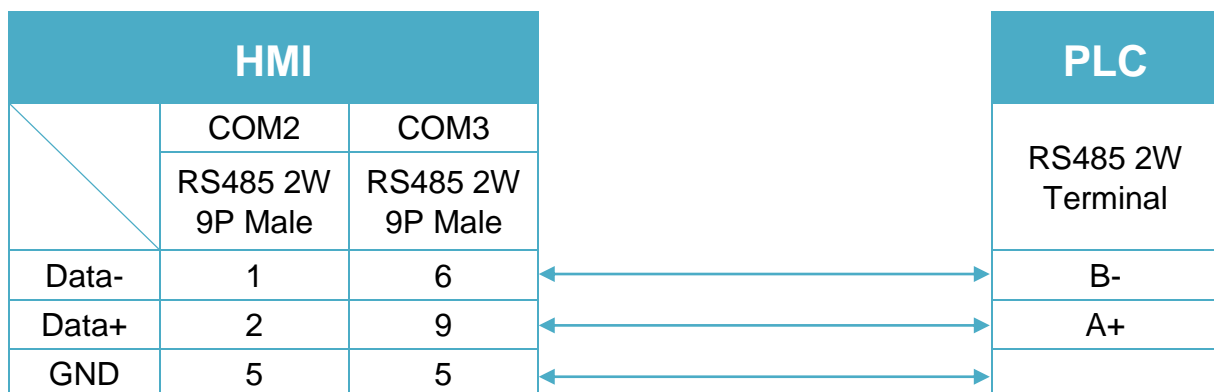


Diagram 8

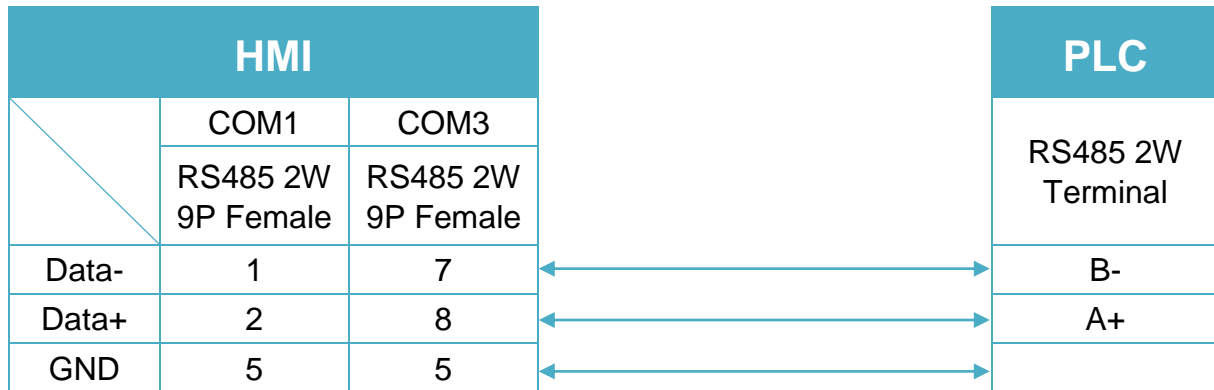
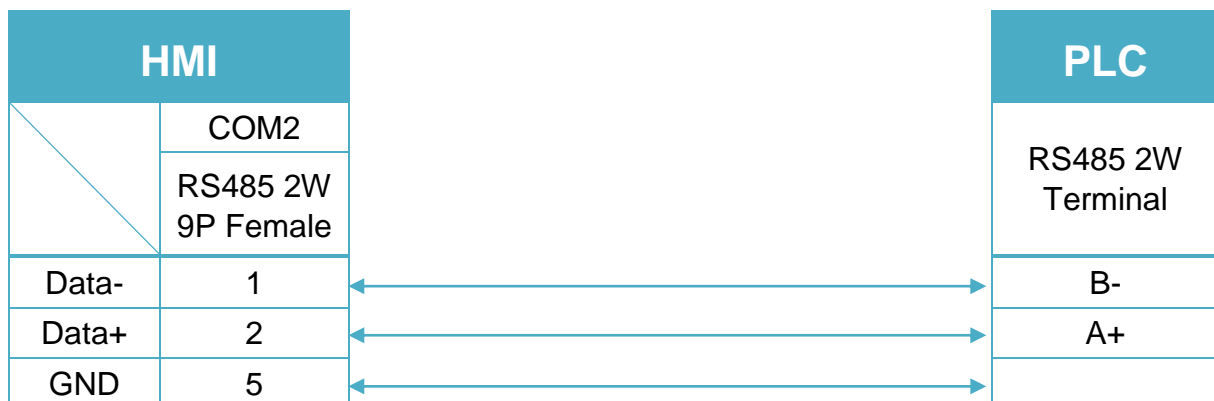
MT-iE *MT8050iE*
MT-iP *MT6051iP*


Diagram 9

MT-iP *MT6071iP / MT8071iP*


Haiwell PLC (Ethernet)

Support Series: Haiwell C series, T Series, H Series, N Series, S Series PLC

Web: <http://www.haiwell.com/>

HMI Setting:

Parameters	Recommended	Options	Notes
PLC type	Haiwell PLC (Ethernet)		
PLC I/F	Ethernet		
Port no.	502		

Device Address:

Bit/Word	Device type	Format	Range	Memo
B	X	DDDD	0 ~ 1023	Input Switch
B	Y	DDDD	0 ~ 1023	Output Switch
B	M	DDDDD	0 ~ 12287	Internal Relay
B	T	DDDD	0 ~ 1023	Timer (Output Coil State)
B	C	DDD	0 ~ 255	Timer (Output Coil State)
B	SM	DDD	0 ~ 215	System Status Bit
B	S	DDDD	0 ~ 2047	Step Bit
W	CR	DDD	0 ~ 255	Special Module Parameter Register
W	AI	DDD	0 ~ 255	Analog Input Register
W	AQ	DDD	0 ~ 255	Analog Output Register
W	V	DDDDD	0 ~ 14847	Data Register
W	TCV	DDDD	0 ~ 1023	Timer (current value register)
W	CCV	DDD	0 ~ 255	Timer (current value register)
W	SV	DDD	0 ~ 900	System Register

Wiring Diagram:

Diagram 1

Ethernet cable:



Hangzhou Maiou MO-TECH

Support Series: LS GLOFA series GM3, GM4, GM6, GM7 CPU Port.

Website: <http://www.lgis.com/>

HMI Setting:

Parameters	Recommended	Options	Notes
PLC type	Hangzhou Maiou MO-TECH		
PLC I/F	RS232		
Baud rate	9600		
Data bits	8		
Parity	None		
Stop bits	1		
PLC sta. no.	1		

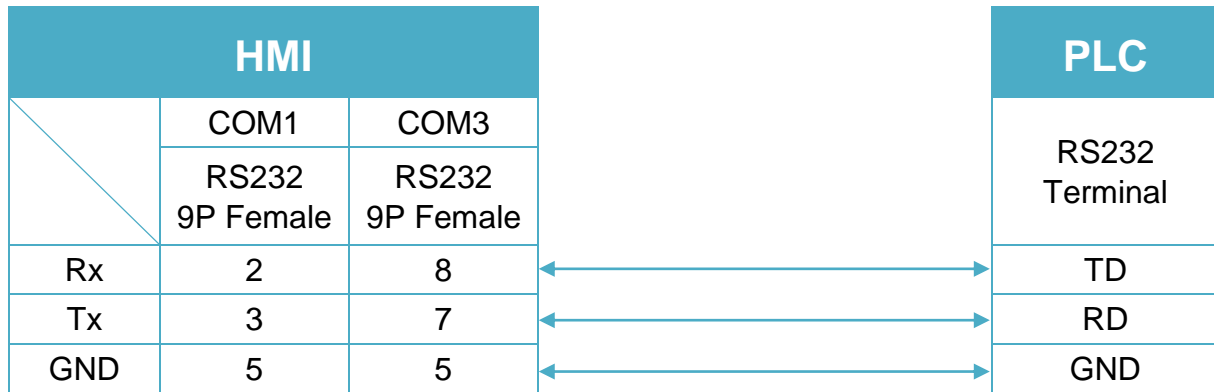
Device Address:

Bit/Word	Device type	Format	Range	Memo
B	MWX	DDDdd	0 ~ 25515	
B	MWX_NO_RPS	DDDdd	0 ~ 25515	
W	MW	DDD	0 ~ 255	
W	MW_NO_RPS	DDD	0 ~ 255	

Wiring Diagram:

Diagram 1

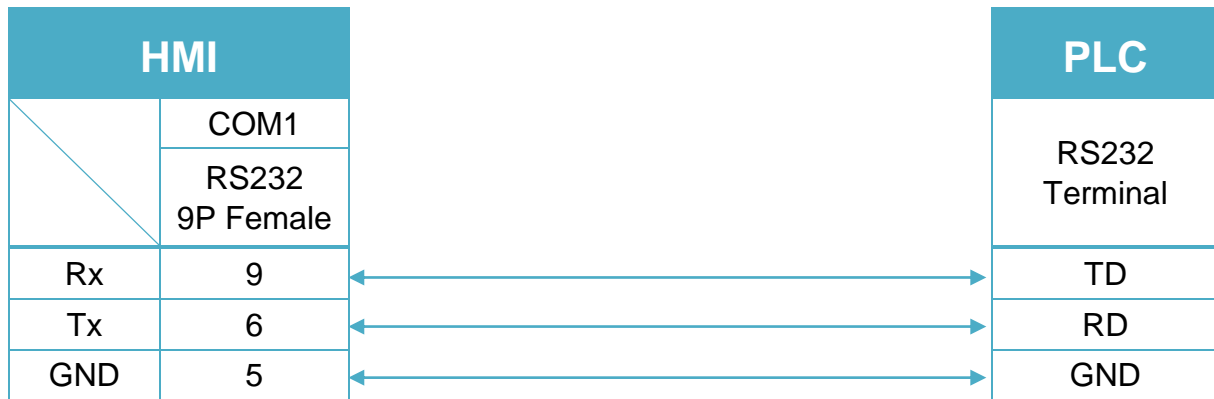
cMT Series	<i>cMT3151</i>
eMT Series	<i>eMT3070 / eMT3105 / eMT3120 / eMT3150</i>
MT-iE	<i>MT8073iE / MT8102iE</i>
MT-XE	<i>MT8092XE</i>
MT-iP	<i>MT6103iP</i>


Diagram 2

cMT Series	<i>cMT-SVR</i>
mTV	<i>mTV</i>
MT-iE	<i>MT8070iE / MT6070iE / MT8100iE / MT8121iE / MT8150iE / MT8071iE / MT6071iE / MT8072iE / MT6072iE / MT8073iE / MT8101iE / MT8102iE / MT8103iE</i>
MT-XE	<i>MT8121XE / MT8150XE / MT8090XE</i>



Diagram 3

MT-iE
MT8050iE
MT-iP
MT6051iP / MT6071iP / MT8071iP


Hanyoung Controller

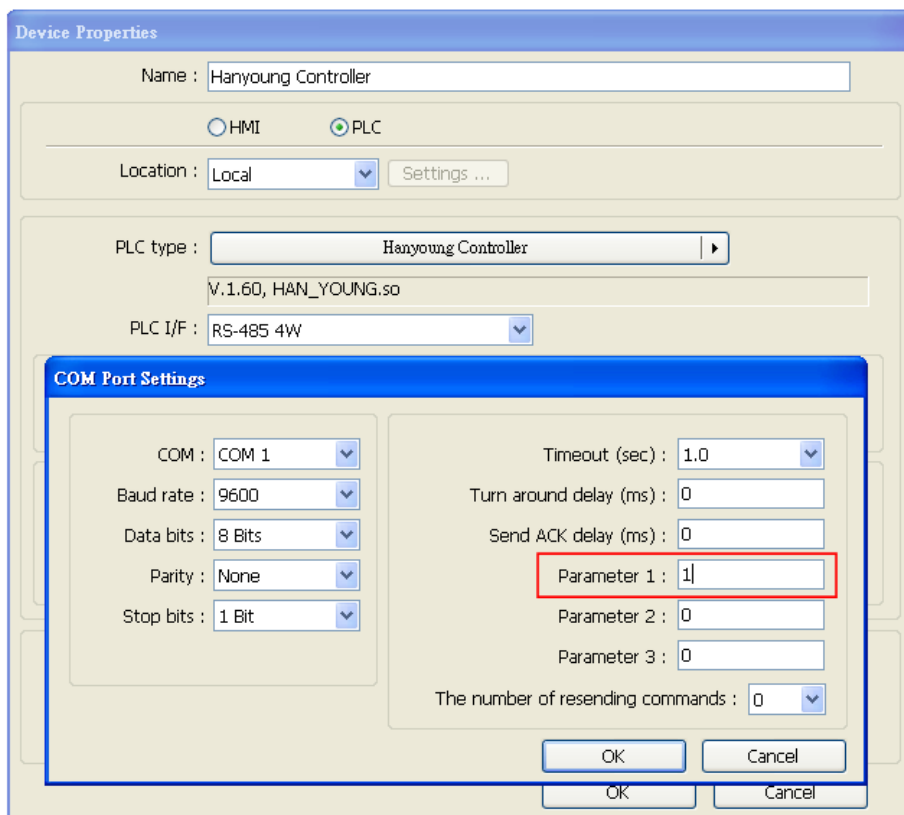
Supported Series: Temperature Controller.

Website: <http://hynux.com/kor/>

HMI Setting:

Parameters	Recommended	Options	Notes
PLC type	Hanyoung Controller		
PLC I/F	RS485 4W		
Baud rate	9600		
Data bits	8	7 or 8	
Parity	None	Even, Odd, None	
Stop bits	1	1 or 2	
PLC sta. no.	1	0-255	

*In System Parameter Settings / Device Settings / COM Settings, set Parameter 1 to “1” to support Check Sum Mode.



Device Address:

Bit/Word	Device type	Format	Range	Memo
B	I	DDDD	1 ~ 9999	
W	D	DDDD	1 ~ 9999	

Wiring Diagram:

Diagram 1

cMT Series	<i>cMT3151</i>
eMT Series	<i>eMT3070 / eMT3105 / eMT3120 / eMT3150</i>
MT-iE	<i>MT8070iE / MT6070iE / MT8100iE / MT8121iE / MT8150iE</i>
MT-XE	<i>MT8121XE / MT8150XE</i>

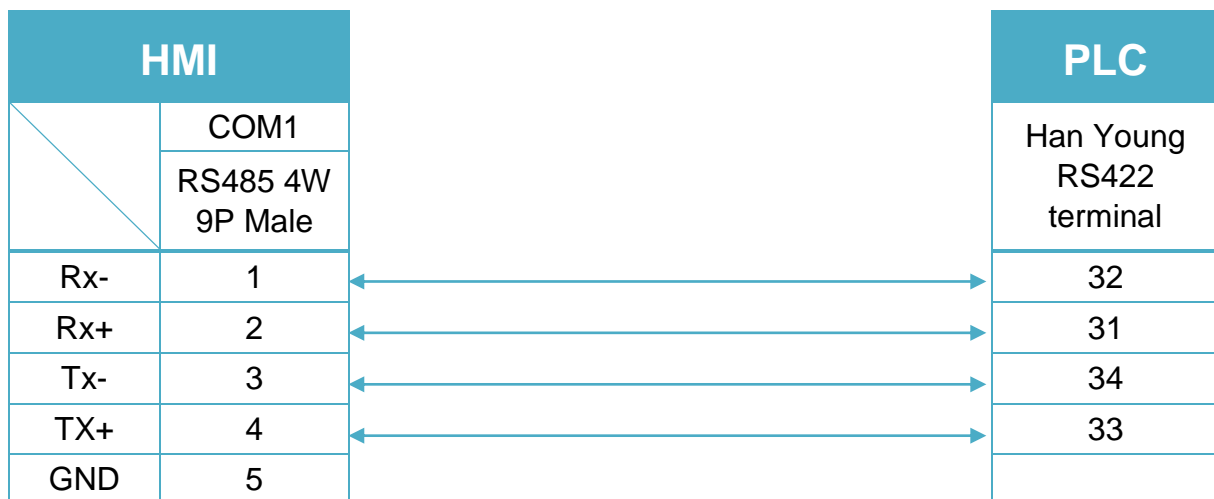


Diagram 2

cMT Series *cMT-SVR*

mTV *mTV*

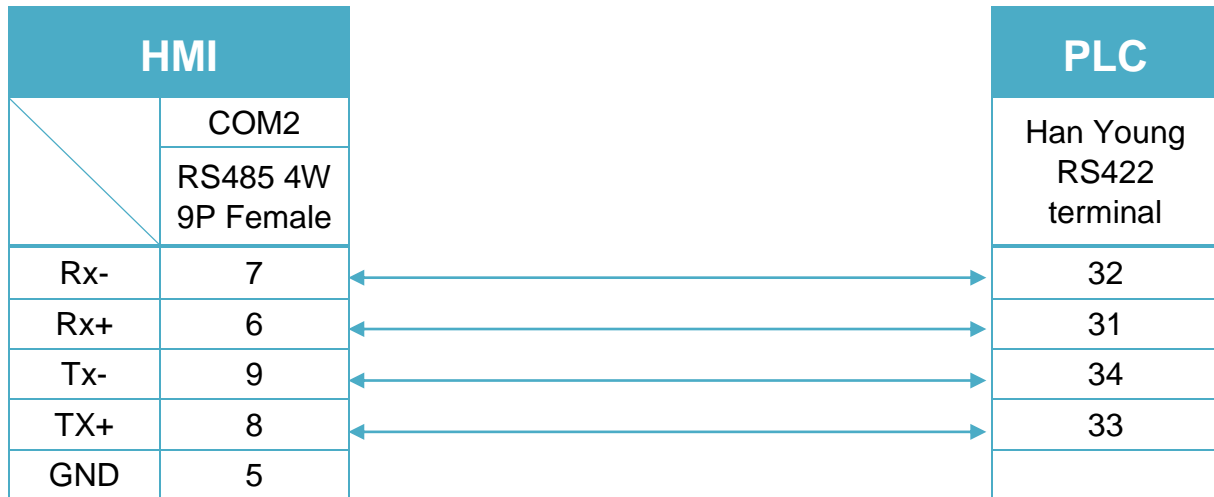


Diagram 3

MT-iE *MT8071iE / MT6071iE / MT8072iE / MT6072iE / MT8073iE /
MT8101iE / MT8102iE / MT8103iE*

MT-XE *MT8090XE / MT8092XE*

MT-iP *MT6071iP / MT8071iP / MT6103iP*

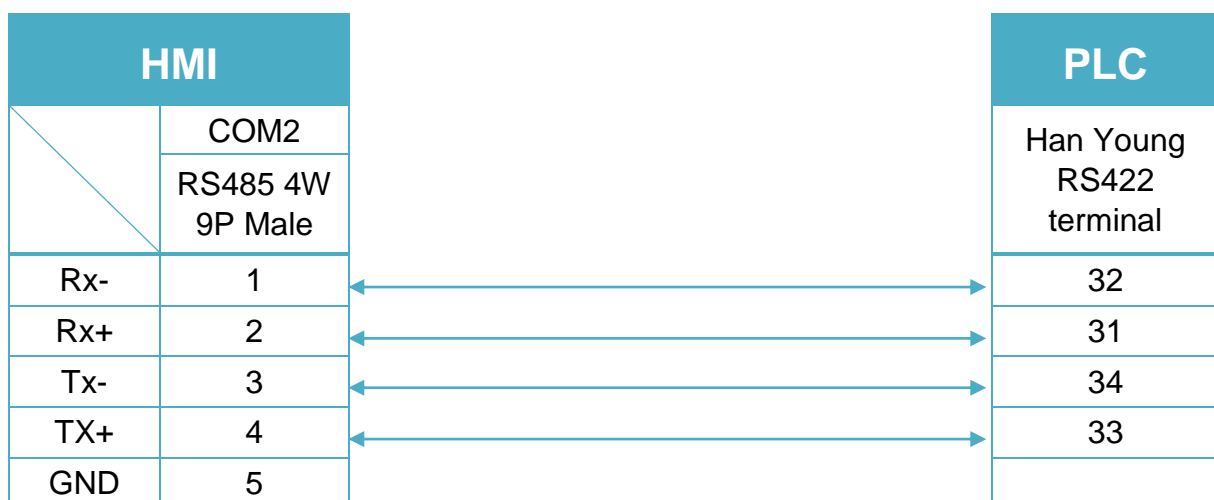
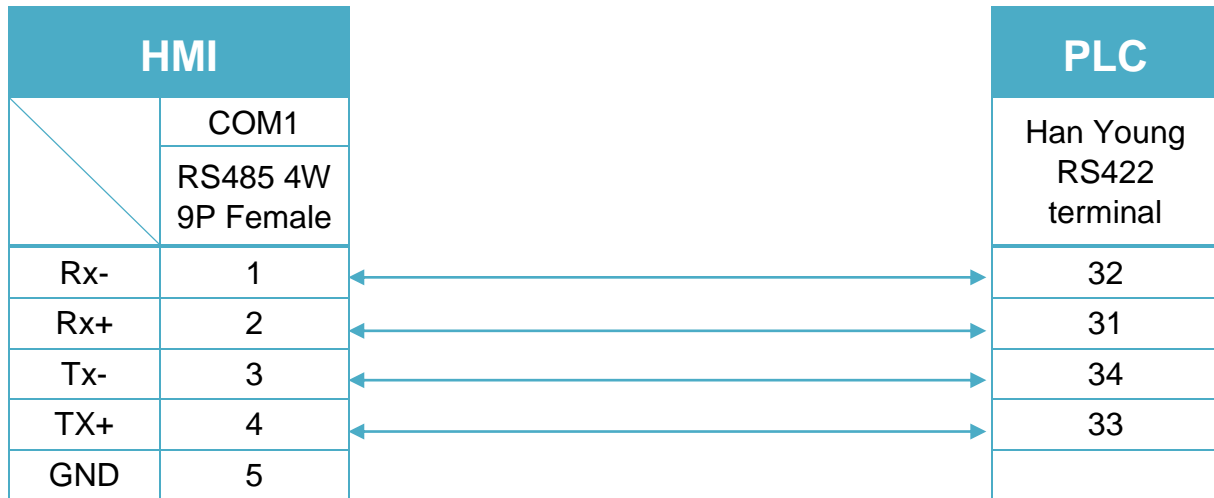


Diagram 4

MT-iE *MT8050iE*

MT-iP *MT6051iP*



HAWE PLVC

Supported Series: HAWE PLVC

Website: <http://www.hawe.de/de/home/>

HMI Setting:

Parameters	Recommended	Options	Notes
PLC type	HAWE PLVC		
PLC I/F	RS232		
Baud rate	9600		
Data bits	8		
Parity	None		
Stop bits	1		
PLC sta. no.	0		

Device Address:

Bit/Word	Device type	Format	Range	Memo
B	X	HHHH	0 ~ ffff	Input Bits
B	Y	HHHH	0 ~ ffff	Output Bits
B	M	DDDDD	0 ~ 65535	Internal Relays
B	T	DDDDD	0 ~ 65535	
B	C	DDDDD	0 ~ 65535	
B	B	HHHH	0 ~ ffff	
B	F	DDDDD	0 ~ 65535	
W	TV	DDDDD	0 ~ 65535	Timer Preset Value
W	CV	DDDDD	0 ~ 65535	Counter Preset Value
W	D	DDDDD	0 ~ 65535	Data Registers
W	W	HHHH	0 ~ ffff	
W	R	DDDDD	0 ~ 65535	

Wiring Diagram:

Diagram 1

cMT Series	<i>cMT3151</i>
eMT Series	<i>eMT3070 / eMT3105 / eMT3120 / eMT3150</i>
MT-iE	<i>MT8073iE / MT8102iE</i>
MT-XE	<i>MT8092XE</i>
MT-iP	<i>MT6103iP</i>

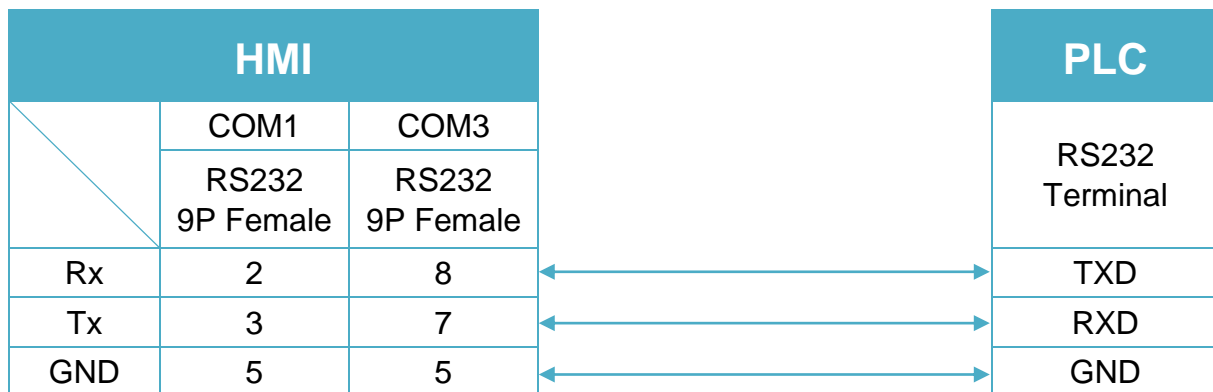


Diagram 2

cMT Series	cMT-SVR
mTV	mTV
MT-iE	MT8070iE / MT6070iE / MT8100iE / MT8121iE / MT8150iE / MT8071iE / MT6071iE / MT8072iE / MT6072iE / MT8073iE / MT8101iE / MT8102iE / MT8103iE
MT-XE	MT8121XE / MT8150XE / MT8090XE

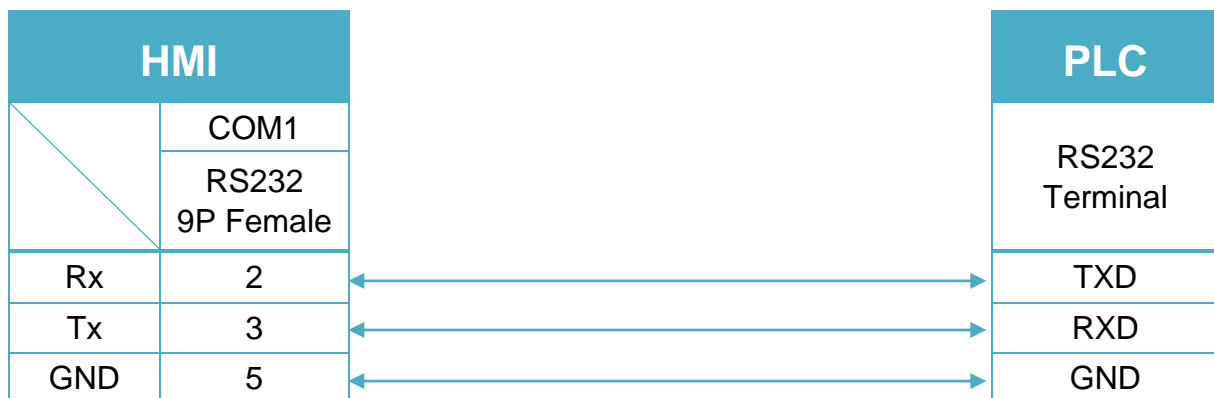


Diagram 3

MT-iE	MT8050iE
MT-iP	MT6051iP / MT6071iP / MT8071iP



HeFei ShenNong Motor

Website: <http://www.ahsngd.com/>

HMI Setting:

Parameters	Recommended	Options	Notes
PLC type	HeFei ShenNong Motor		
PLC I/F	RS485 4W		
Baud rate	9600		
Data bits	8		
Parity	None		
Stop bits	1		
PLC sta. no.	1		

Device Address:

Bit/Word	Device type	Format	Range	Memo
W	ADDR00	H	1 ~ D	
W	ADDR01	H	1 ~ D	
W	ADDR02	H	1 ~ D	
W	ADDR03	H	1 ~ D	
W	ADDR04	H	1 ~ D	
W	ADDR05	H	1 ~ D	
W	ADDR06	H	1 ~ D	
W	ADDR07	H	1 ~ D	
W	ADDR08	H	1 ~ D	
W	ADDR09	H	1 ~ D	
W	ADDR0a	H	1 ~ D	
W	ADDR0b	H	1 ~ D	
W	ADDR0c	H	1 ~ D	
W	ADDR0d	H	1 ~ D	
W	ADDR0e	H	1 ~ D	
W	ADDR0f	H	1 ~ D	
W	ADDR3f	H	0 ~ b	
W	DATAN	D	0 ~ 5	

Wiring Diagram:

Diagram 1

cMT Series	<i>cMT3151</i>
eMT Series	<i>eMT3070 / eMT3105 / eMT3120 / eMT3150</i>
MT-iE	<i>MT8070iE / MT6070iE / MT8100iE / MT8121iE / MT8150iE</i>
MT-XE	<i>MT8121XE / MT8150XE</i>

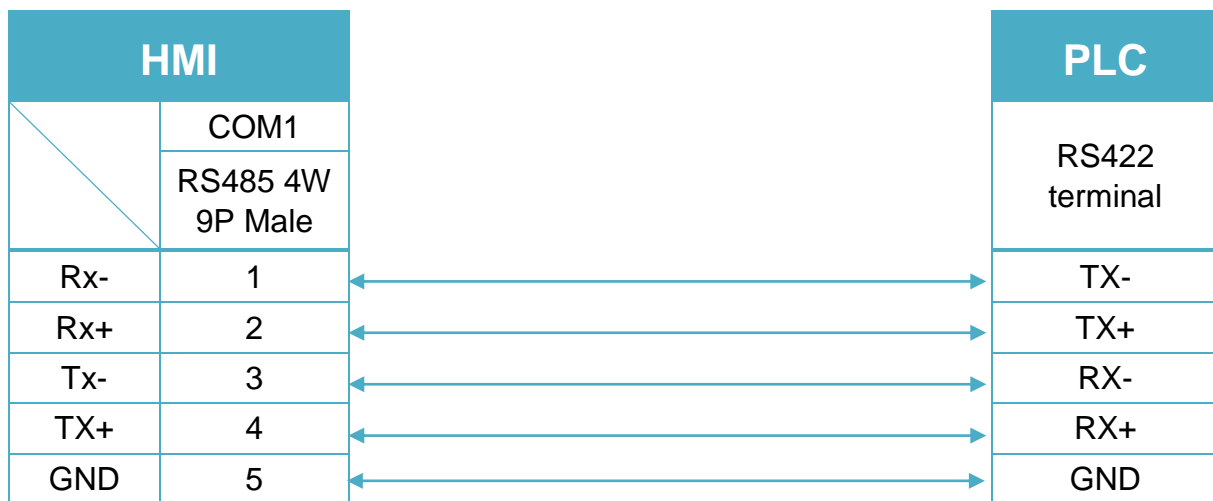


Diagram 2

cMT Series	<i>cMT-SVR</i>
mTV	<i>mTV</i>

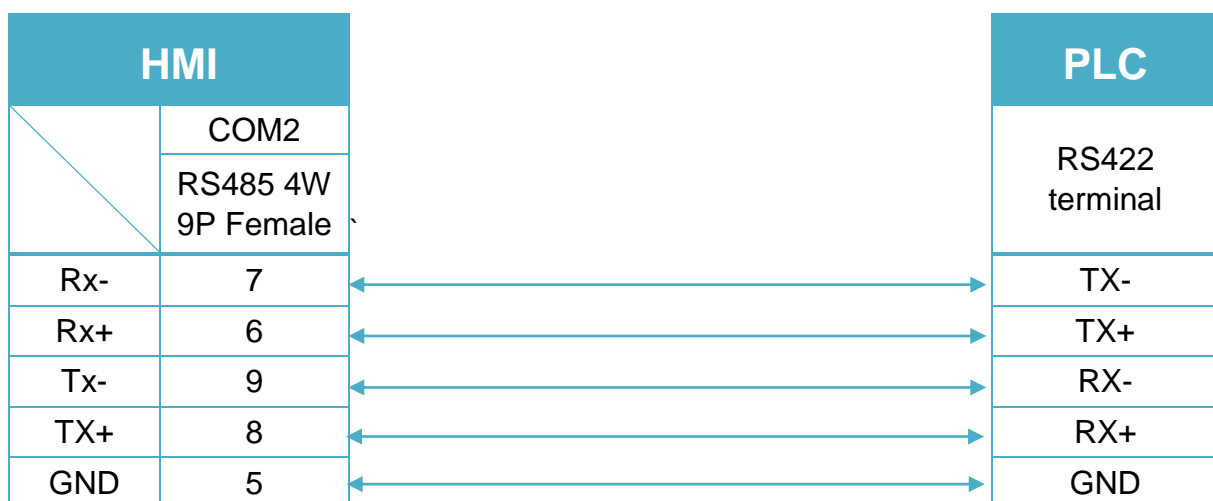


Diagram 3

MT-iE	<i>MT8071iE / MT6071iE / MT8072iE / MT6072iE / MT8073iE / MT8101iE / MT8102iE / MT8103iE</i>
MT-XE	<i>MT8090XE / MT8092XE</i>
MT-iP	<i>MT6071iP / MT8071iP / MT6103iP</i>



Diagram 4

MT-iE	<i>MT8050iE</i>
MT-iP	<i>MT6051iP</i>



Heng Yuan EU series

Supported Series: EU series, EU5 series, EU10 series.

Website: <http://www.tjhysensor.cn/>

HMI Setting:

Parameters	Recommended	Options	Notes
PLC type	Heng Yuan EU series		
PLC I/F	RS485 2W		
Baud rate	9600		
Data bits	8		
Parity	Even		
Stop bits	1		
PLC sta. no.	2	1-31	

Online simulator	YES
Extend address mode	YES

Device Address:

Bit/Word	Device type	Format	Range	Memo
W	Parameter	DDDD	0 ~ 2000	

Wiring Diagram:

The following is the view from the soldering point of a connector.

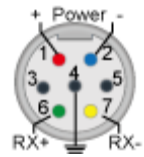


Diagram 1

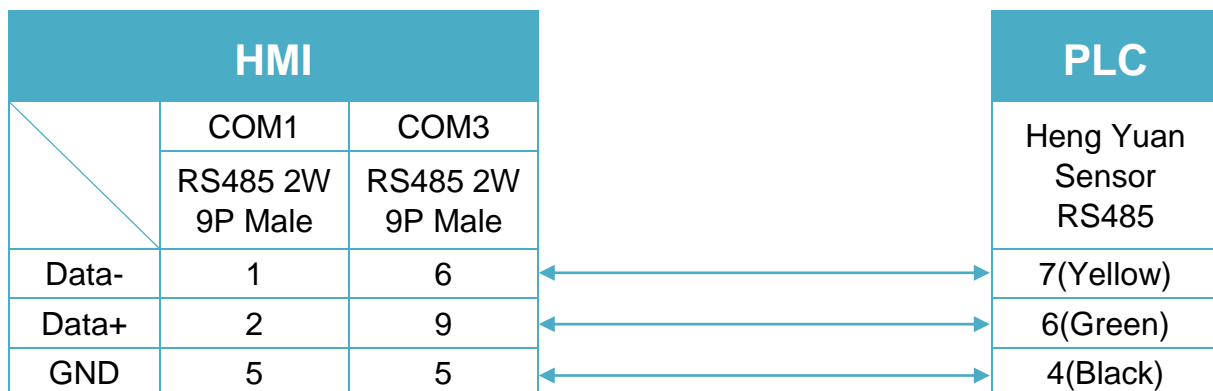
cMT Series
cMT3151
eMT Series
eMT3070 / eMT3105 / eMT3120 / eMT3150


Diagram 2

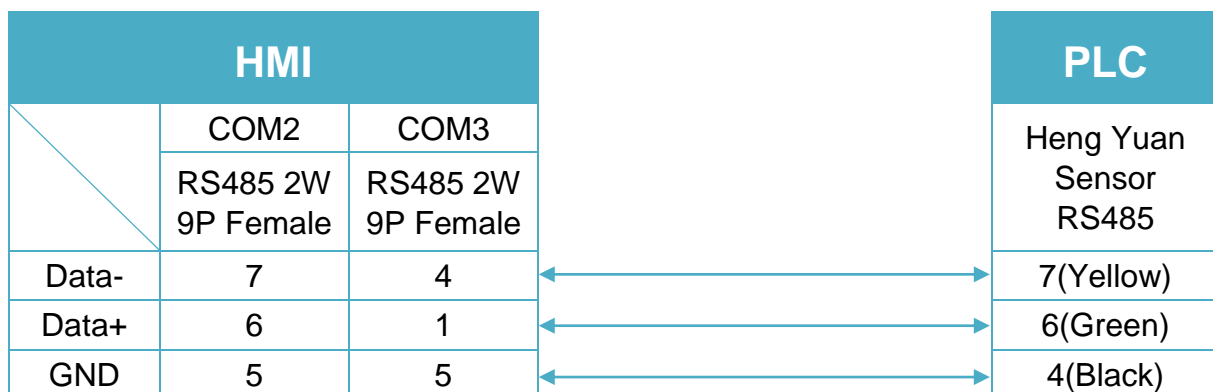
cMT Series
cMT-SVR
mTV
mTV


Diagram 3

MT-iE *MT8070iE / MT6070iE / MT8100iE / MT8121iE / MT8150iE*

MT-XE *MT8121XE / MT8150XE*

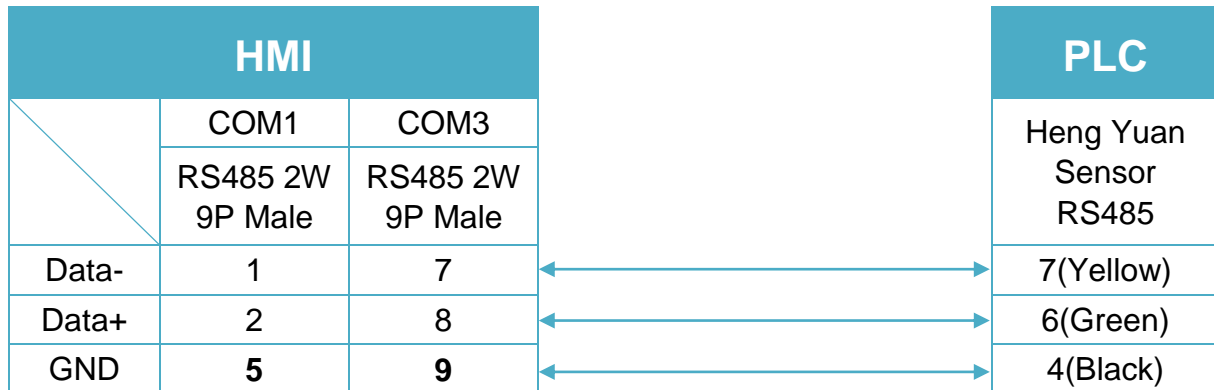


Diagram 4

MT-iE *MT8071iE / MT6071iE / MT8072iE / MT6072iE / MT8073iE / MT8101iE / MT8102iE / MT8103iE*

MT-XE *MT8090XE / MT8092XE*

MT-iP *MT6103iP*

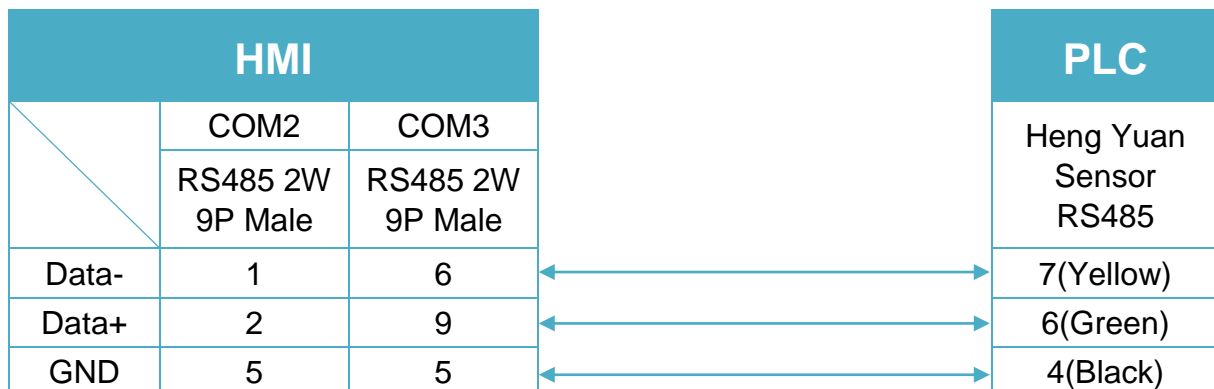


Diagram 5

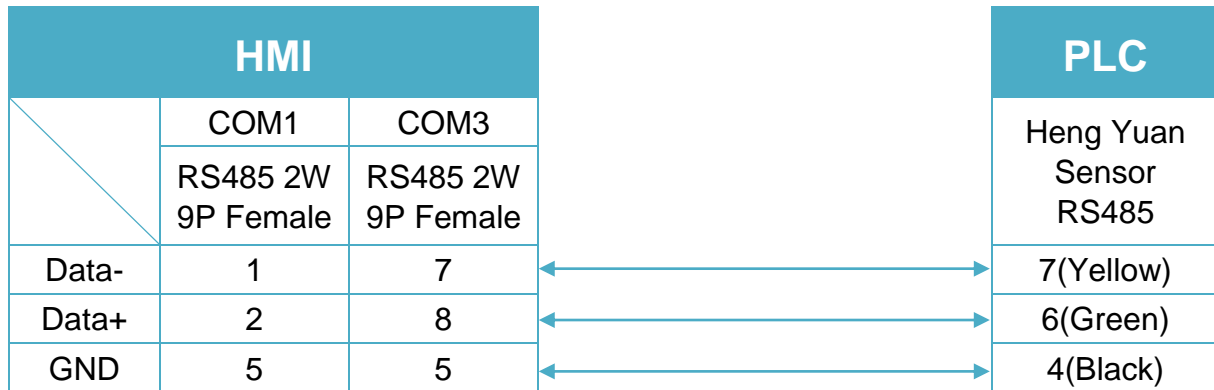
MT-iE *MT8050iE*
MT-iP *MT6051iP*


Diagram 6

MT-iP *MT6071iP / MT8071iP*


Hitachi EH-SIO

HMI Setting:

Parameters	Recommended	Options	Notes
PLC type	Hitachi EH-SIO		
PLC I/F	RS232	RS232, RS485	
Baud rate	19200	9600, 19200, 38400	
Data bits	7	7	
Parity	Even	Even	
Stop bits	1	1	
PLC sta. no.	0		

PLC Setting:

Communication mode	19200, E, 7, 1 (default)
---------------------------	--------------------------

Device Address:

Bit/Word	Device type	Format	Range	Memo
B	X	HHHHh	0 ~ ffff	External input-bit (X)
B	Y	HHHHh	0 ~ ffff	External output-bit (Y)
B	M	HHHHh	0 ~ ffff	Data area-bit (M)
B	T	HHHHh	0 ~ ffff	Timer (T)
B	R	HHHHh	0 ~ ffff	Internal output (R)
B	L	HHHHh	0 ~ ffff	Link area-bit (L)
W	TC	HH	0 ~ ff	Timer/Counter current value
W	WM	HHHH	0 ~ 270f	Data area-word (M)
W	WX	HHHH	0 ~ 270f	External input-word (X)
W	WY	HHHH	0 ~ 270f	External output-word (Y)
W	WR	HHHH	0 ~ 270f	Internal output-word (R)
W	WL	HHHH	0 ~ 270f	Link area-word (L)

Wiring Diagram:

EH-SIO port1/port 2 RS232

Diagram 1

cMT Series	<i>cMT3151</i>
eMT Series	<i>eMT3070 / eMT3105 / eMT3120 / eMT3150</i>
MT-iE	<i>MT8073iE / MT8102iE</i>
MT-XE	<i>MT8092XE</i>
MT-iP	<i>MT6103iP</i>

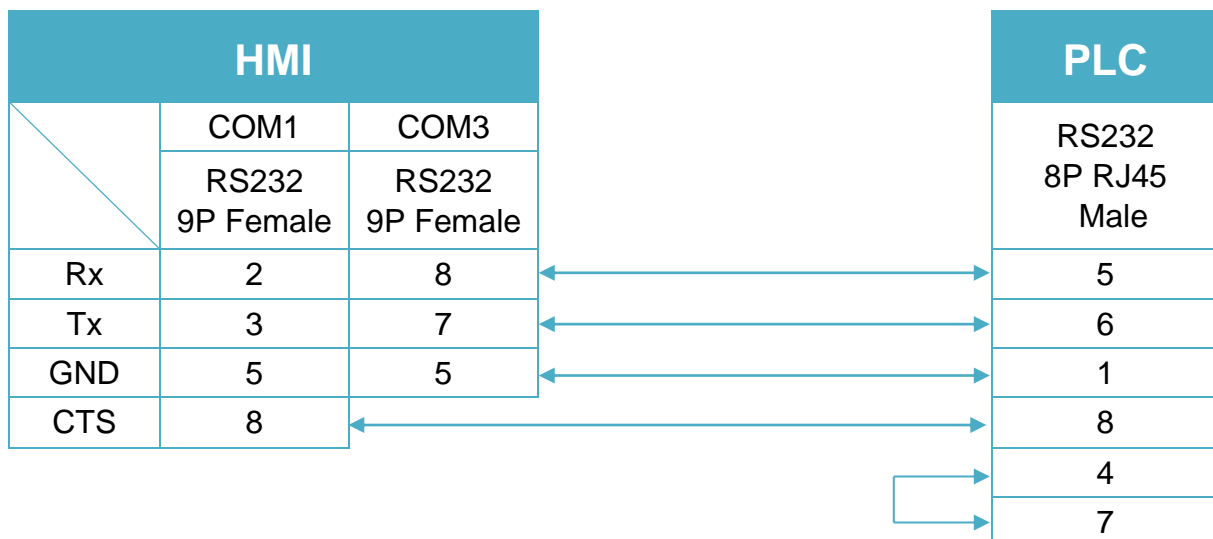


Diagram 2

cMT Series	cMT-SVR
mTV	mTV
MT-iE	MT8070iE / MT6070iE / MT8100iE / MT8121iE / MT8150iE / MT8071iE / MT6071iE / MT8072iE / MT6072iE / MT8073iE / MT8101iE / MT8102iE / MT8103iE
MT-XE	MT8121XE / MT8150XE / MT8090XE /

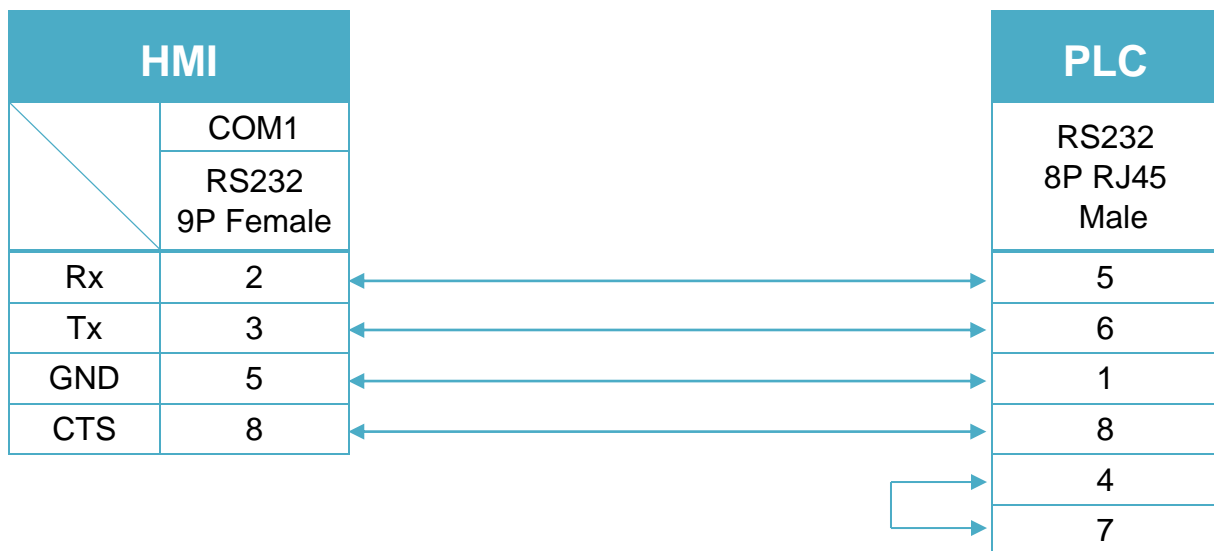
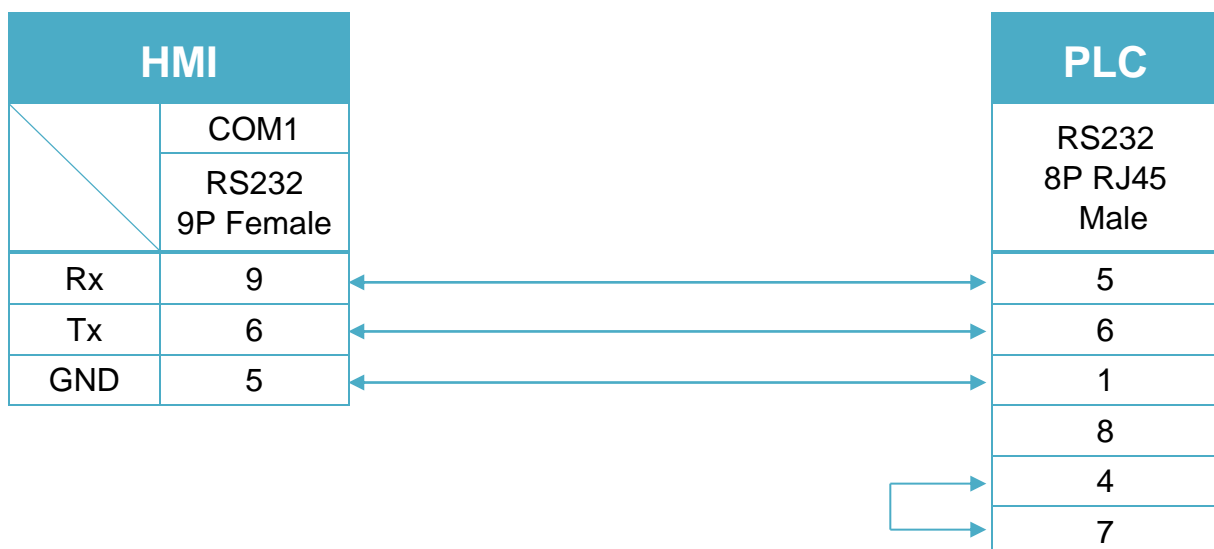


Diagram 3

MT-iE	MT8050iE
MT-iP	MT6051iP / MT6071iP / MT8071iP



The following is the view from the soldering point of a connector.



Diagram 4

cMT Series	<i>cMT3151</i>
eMT Series	<i>eMT3070 / eMT3105 / eMT3120 / eMT3150</i>
MT-iE	<i>MT8070iE / MT6070iE / MT8100iE / MT8121iE / MT8150iE</i>
MT-XE	<i>MT8121XE / MT8150XE</i>

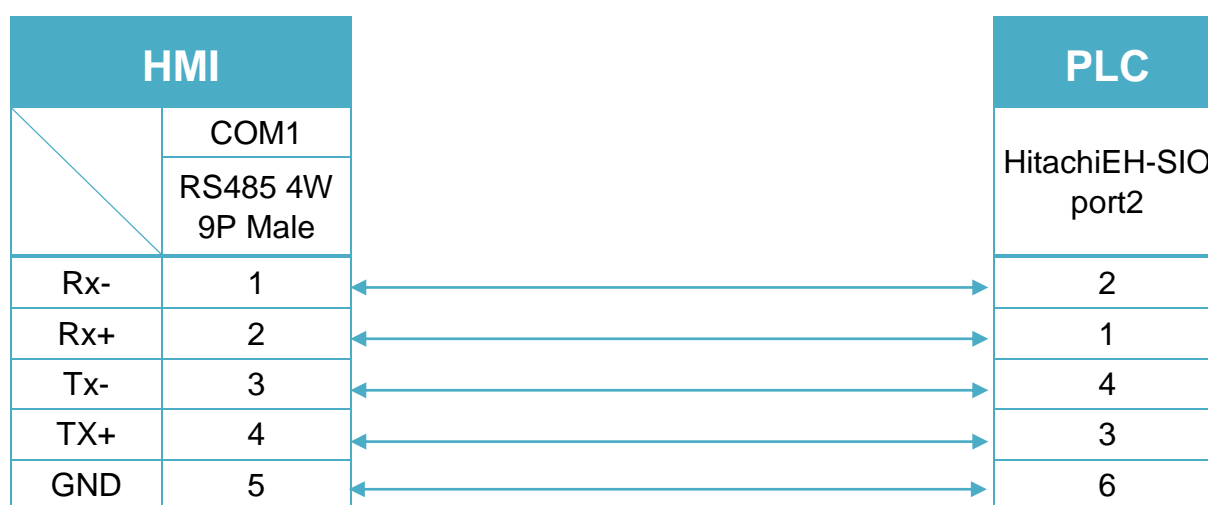


Diagram 5

cMT Series	<i>cMT-SVR</i>
mTV	<i>mTV</i>

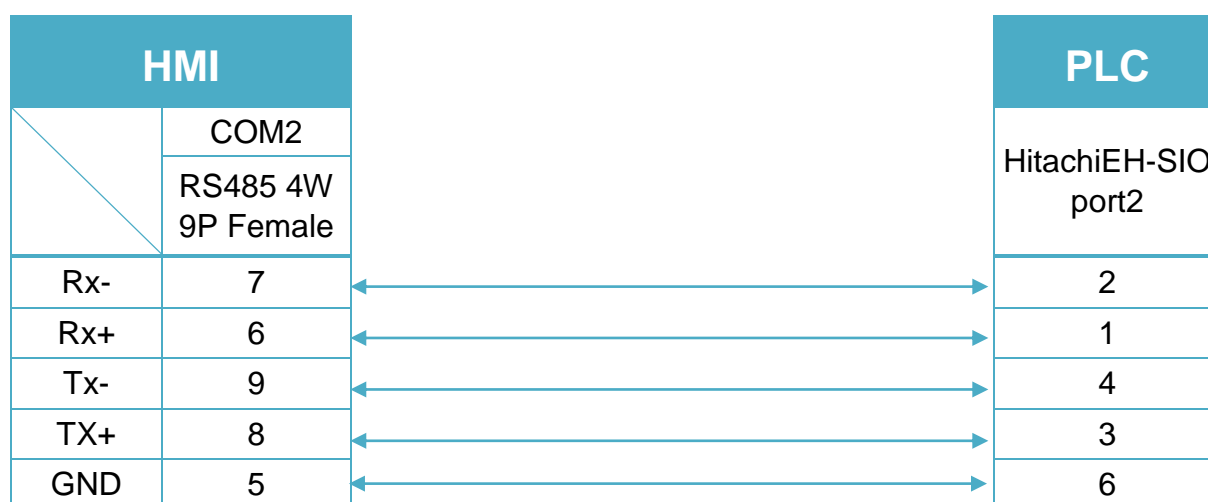


Diagram 6

MT-iE	<i>MT8071iE / MT6071iE / MT8072iE / MT6072iE / MT8073iE / MT8101iE / MT8102iE / MT8103iE</i>
MT-XE	<i>MT8090XE / MT8092XE</i>
MT-iP	<i>MT6071iP / MT8071iP / MT6103iP</i>

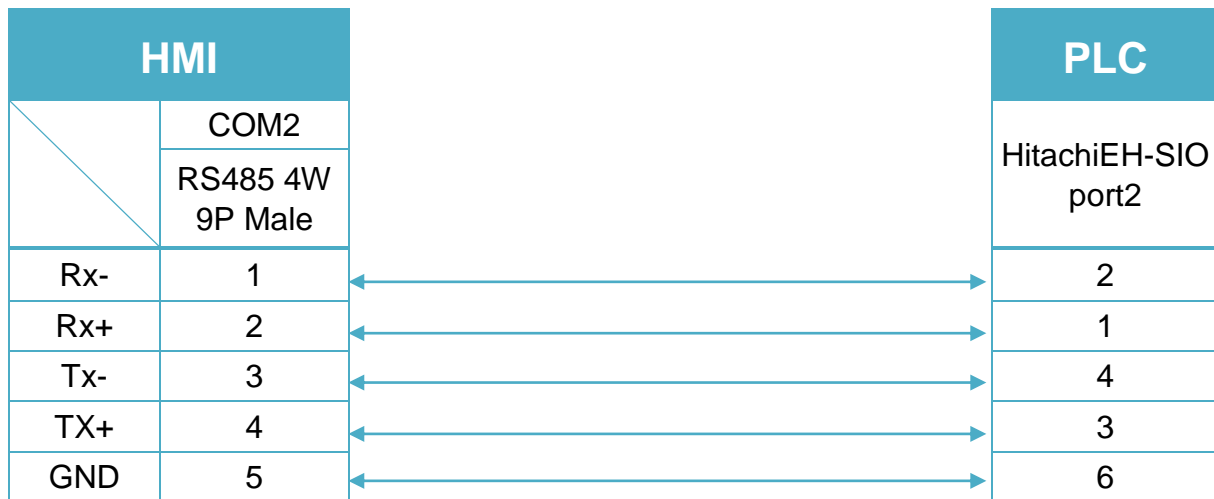


Diagram 7

MT-iE	<i>MT8050iE</i>
MT-iP	<i>MT6051iP</i>

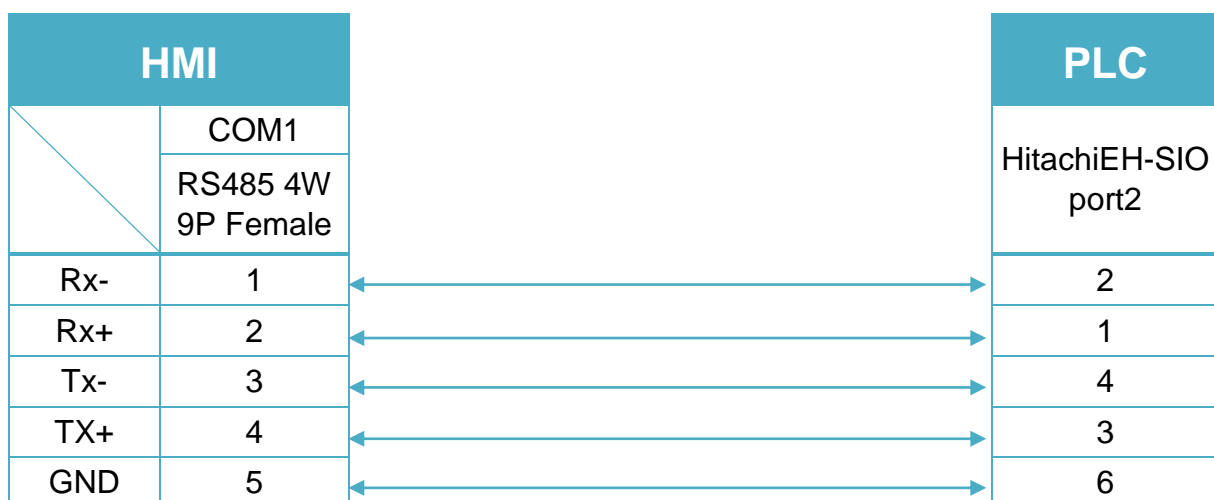


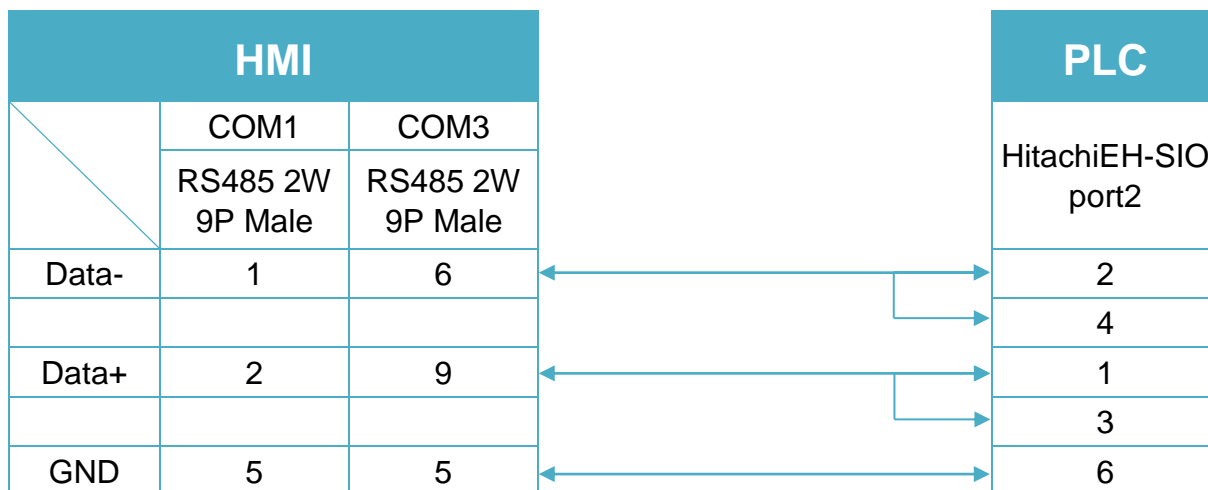
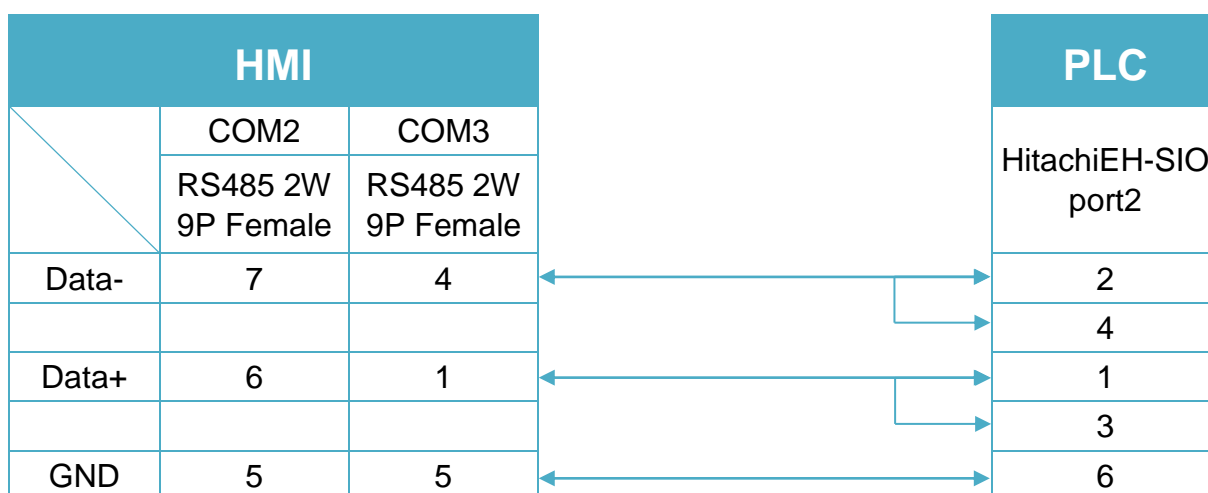
Diagram 8
cMT Series
cMT3151
eMT Series
eMT3070 / eMT3105 / eMT3120 / eMT3150

Diagram 9
cMT Series
cMT-SVR
mTV
mTV


Diagram 10

MT-iE *MT8070iE / MT6070iE / MT8100iE / MT8121iE / MT8150iE*

MT-XE *MT8121XE / MT8150XE*

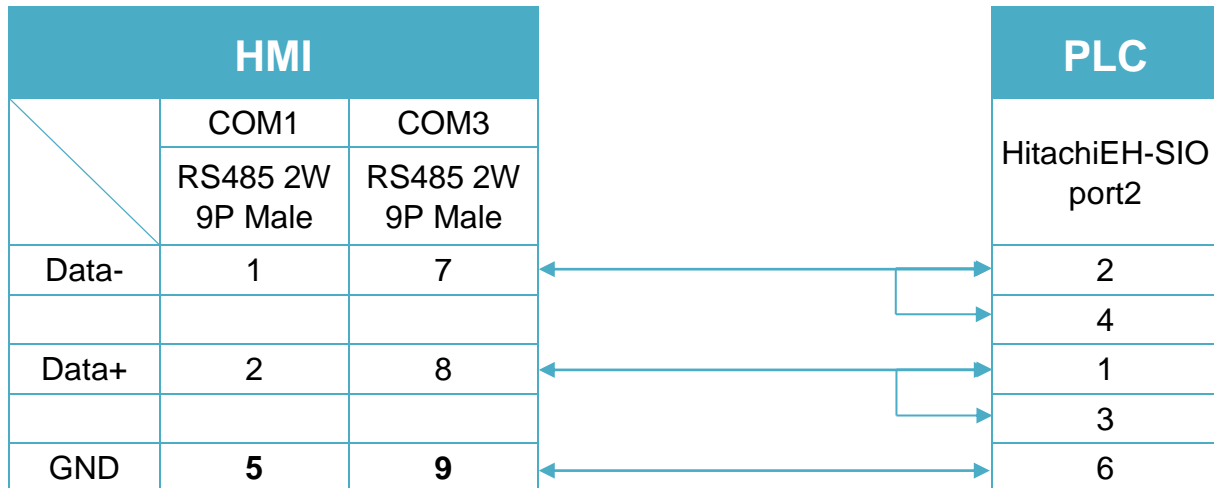


Diagram 11

MT-iE *MT8071iE / MT6071iE / MT8072iE / MT6072iE / MT8073iE / MT8101iE / MT8102iE / MT8103iE*

MT-XE *MT8090XE / MT8092XE*

MT-iP *MT6103iP*

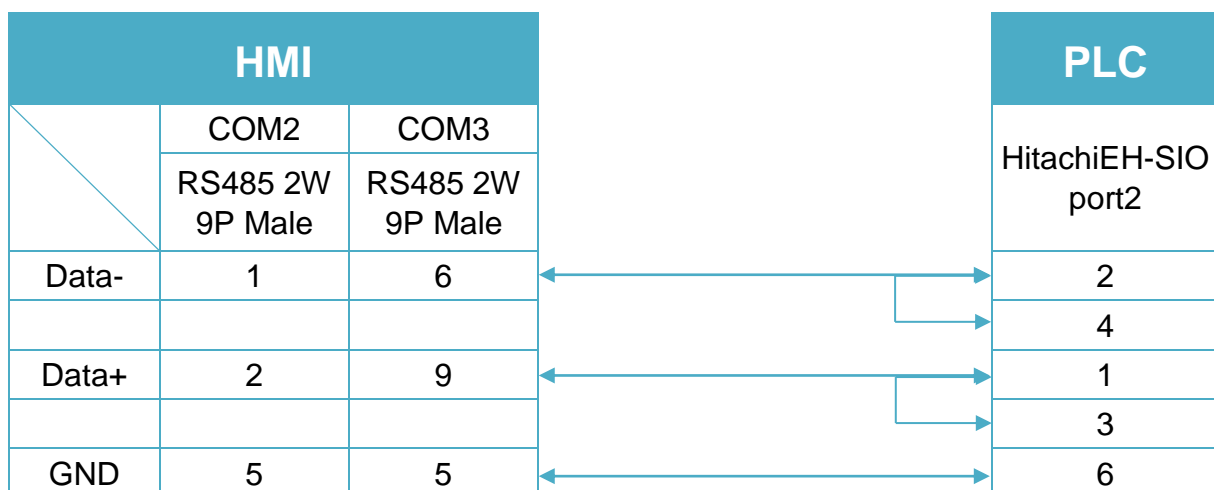


Diagram 12

MT-iE *MT8050iE*

MT-iP *MT6051iP*

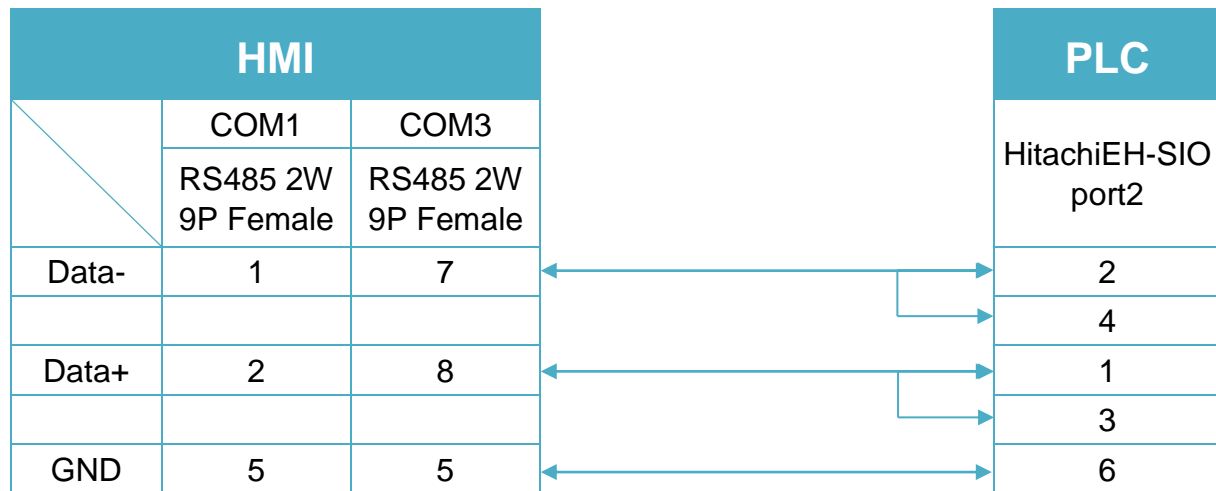
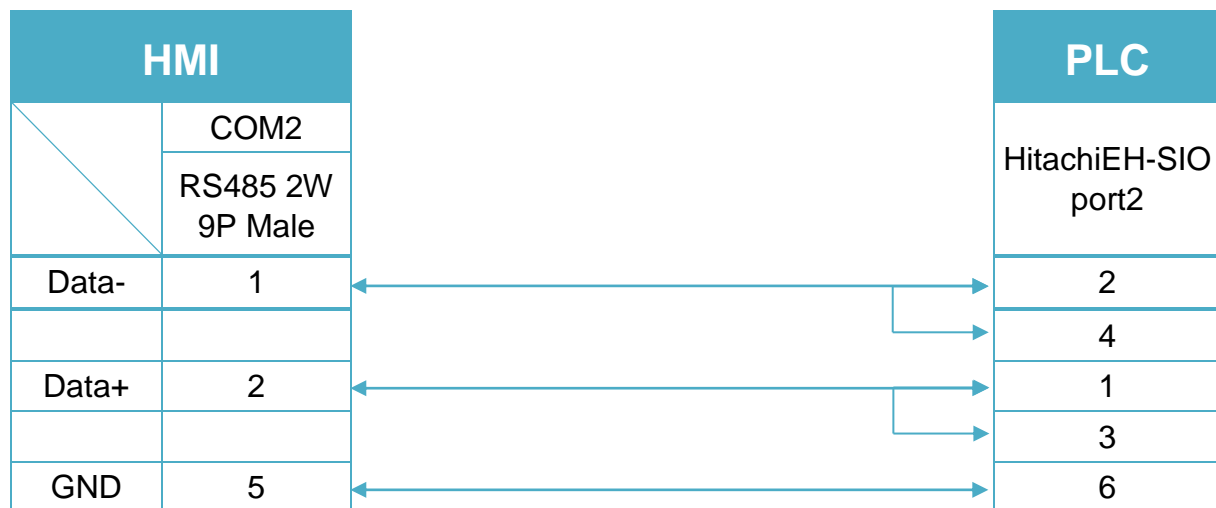


Diagram 13

MT-iP *MT6071iP / MT8071iP*



Hitachi EHV Series (Ethernet)

Website: <http://www.hitachi-ies.co.jp/english/products/plc/index.htm>

HMI Setting:

Parameters	Recommended	Options	Notes
PLC type	Hitachi EHV Series (Ethernet)		
PLC I/F	Ethernet		
Port no.	3004	3004~3007	

Device Address:

Bit/Wor	Device type	Format	Range	Memo
B	X_Dec	HHHdd	0 ~ 4ff95	External input-bit (X)
B	Y_Dec	HHHdd	0 ~ 4ff95	External output-bit (Y)
B	X	HHHHh	0 ~ ffff	External input-bit (X)
B	Y	HHHHh	0 ~ ffff	External output-bit (Y)
B	M	HHHHh	0 ~ ffff	Data area-bit (M)
B	T	DDDDD	0 ~ 65535	Timer (T)
B	R	HHHHh	0 ~ ffff	Internal output (R)
B	L	HHHHh	0 ~ ffff	Link area-bit (L)
W	TC	DDDD	0 ~ 2559	Timer/Counter current value
W	WM	HHHH	0 ~ 7fff	Data area-word (M)
W	WX	HHHH	0 ~ ffff	External Input-word (X)
W	WY	HHHH	0 ~ ffff	External output-word (Y)
W	WR	HHHH	0 ~ ffff	Internal output-word (R)
W	WL	HHHH	0 ~ 73ff	Link area-word (L)

Wiring Diagram:

Ethernet cable:



Hitachi H/EH/EHV Series

Supported Series: Hitachi H series, EH-150, Micro-EH, H20, H40, H64, H200, H250, H252, H300, H302, H700, H702, H1000, H1002, H2000, H4010.

Website: <http://www.hitachi-ies.co.jp/english/products/plc/index.htm>

HMI Setting:

Parameters	Recommended	Options	Notes
PLC type	Hitachi H/EH/EHV Series		
PLC I/F	RS232	RS232, RS485	
Baud rate	19200	9600, 19200, 38400	
Data bits	7	7	
Parity	Even	Even	
Stop bits	1	1	
PLC sta. no.	0	0-255	Does not apply to this protocol.

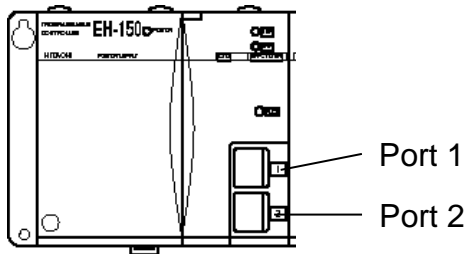
Online simulator	YES	Broadcast command	NO
Extend address mode	NO		

Device Address:

Bit/Wor	Device type	Format	Range	Memo
B	X_Dec	HHHdd	0 ~ 4ff95	
B	Y_Dec	HHHdd	0 ~ 4ff95	
B	X	HHHHh	0 ~ ffff	External input-bit (X)
B	Y	HHHHh	0 ~ ffff	External output-bit (Y)
B	M	HHHHh	0 ~ ffff	Data area-bit (M)
B	T	HHHHh	0 ~ ffff	Timer (T)
B	R	HHHHh	0 ~ ffff	Internal output (R)
B	L	HHHHh	0 ~ ffff	Link area-bit (L)
W	TC	HH	0 ~ ff	Timer/Counter current value
W	WM	HHHH	0 ~ 270f	Data area-word (M)
W	WX	HHHH	0 ~ 270f	External input-word (X)
W	WY	HHHH	0 ~ 270f	External output-word (Y)
W	WR	HHHH	0 ~ c3ff	Internal output-word (R)
W	WL	HHHH	0 ~ 270f	Link area-word (L)

Wiring Diagram:

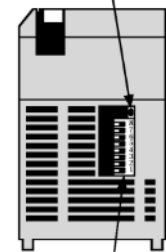
WARNING: If your communication cable is not wired exactly as shown in our cable assembly instructions, damage to the HMI or loss of communications can be caused.



CPU TYPE	Port 1	Port 2
EH-150/CPU 104A	RS-232	RS-232
EH-150/CPU 208A	RS-232	RS-232
EH-150/CPU 308A	RS-232/RS-485	RS-232
EH-150/CPU 316A	RS-232/RS-485	RS-232
EH-150/CPU 448A	RS-232/RS-485	RS-232





Switch Number				
1	OFF	Normal mode		
2	OFF	TRNS0 operation		
3, 4	3	4	Port1 transmission speed	
	ON	ON	4,800 bps	Doesn't support
	OFF	ON	9,600 bps	
	ON	OFF	19,200 bps	Default
	OFF	OFF	38,400 bps	
5	ON	Dedicated port		
6	6	PHL	Port2 transmission speed	
	ON	Low	9,600 bps	
	ON	High	38,400 bps	
	OFF	Low	4,800 bps	Doesn't support
	OFF	High	19,200 bps	Default
7	OFF	(System mode)		Do not turn on.
8	OFF	(System mode)		Do not turn on.

Port setting toggle-switch



Mode setting DIP-switch

Toggle-Switch

PHL	ON	
Low	OFF	
PHL	ON	
High	OFF	

EH-150 port1/port 2 RS232 / MICRO-EH port1 RS232 (Diagram 1 ~ Diagram3)

Diagram 1

cMT Series	<i>cMT3151</i>
eMT Series	<i>eMT3070/ eMT3105 / eMT3120 / eMT3150</i>
MT-iE	<i>MT8073iE / MT8102iE</i>
MT-XE	<i>MT8092XE</i>
MT-iP	<i>MT6103iP</i>

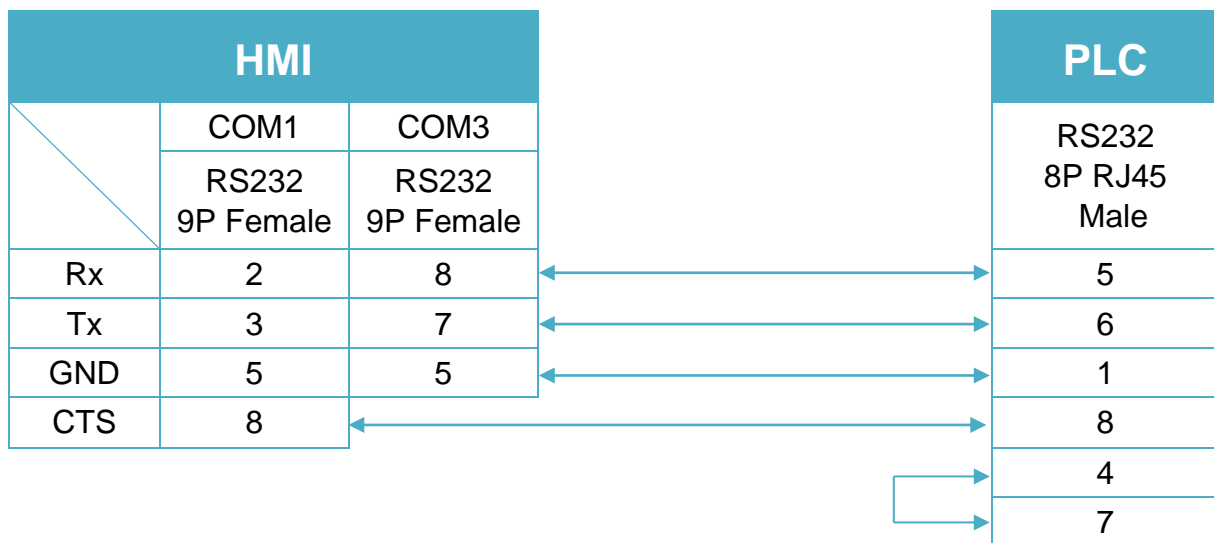


Diagram 2

cMT Series	cMT-SVR
mTV	mTV
MT-iE	MT8070iE / MT6070iE / MT8100iE / MT8121iE / MT8150iE / MT8071iE / MT6071iE / MT8072iE / MT6072iE / MT8073iE / MT8101iE / MT8102iE / MT8103iE
MT-XE	MT8121XE / MT8150XE / MT8090XE /

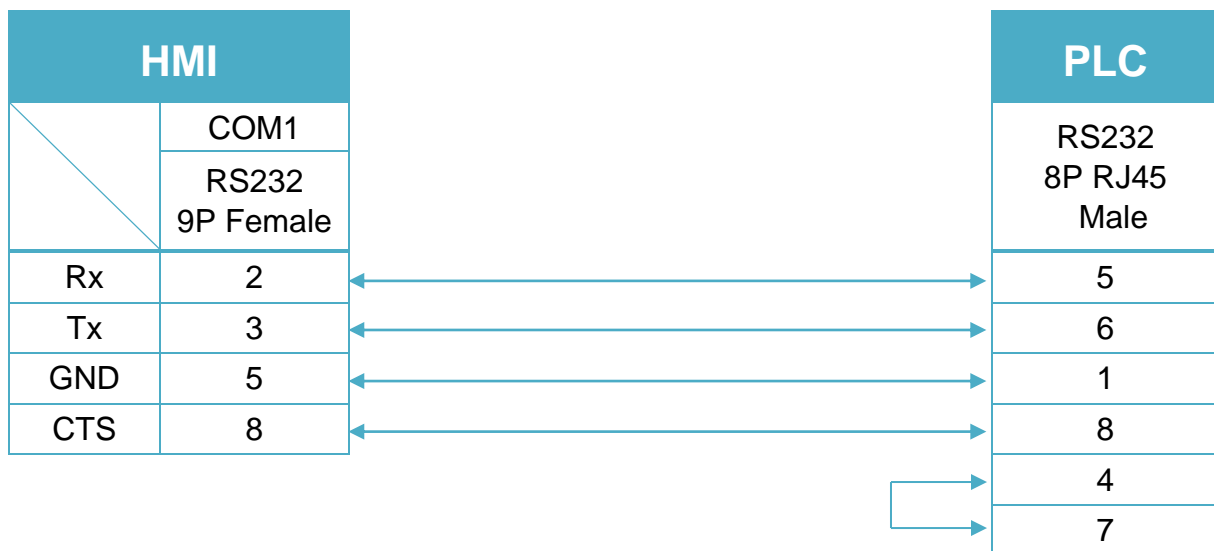
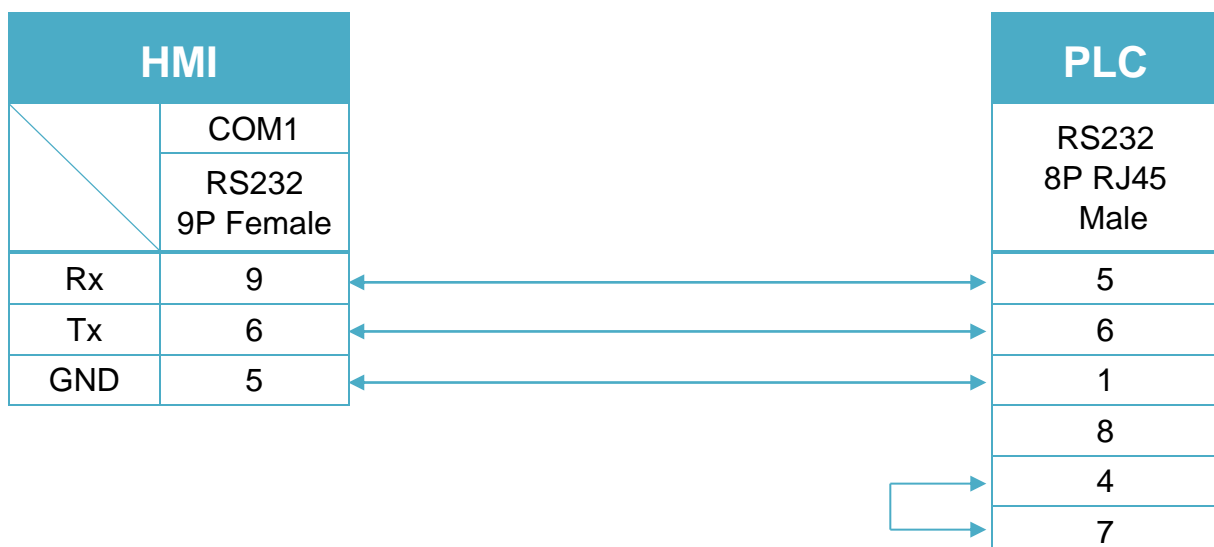


Diagram 3

MT-iE	MT8050iE
MT-iP	MT6051iP / MT6071iP / MT8071iP



EH-150 port1 RS485 4W (Diagram 4 ~ Diagram7)

Diagram 4

cMT Series	<i>cMT3151</i>
eMT Series	<i>eMT3070/ eMT3105 / eMT3120 / eMT3150</i>
MT-iE	<i>MT8070iE / MT6070iE / MT8100iE / MT8121iE / MT8150iE</i>
MT-XE	<i>MT8121XE / MT8150XE</i>

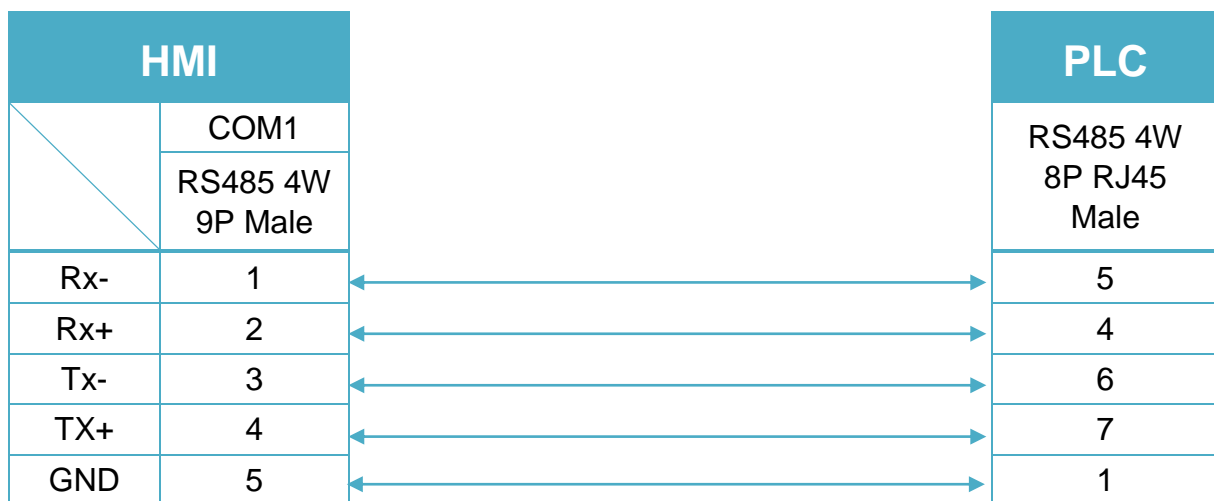


Diagram 5

cMT Series	<i>cMT-SVR</i>
mTV	<i>mTV</i>

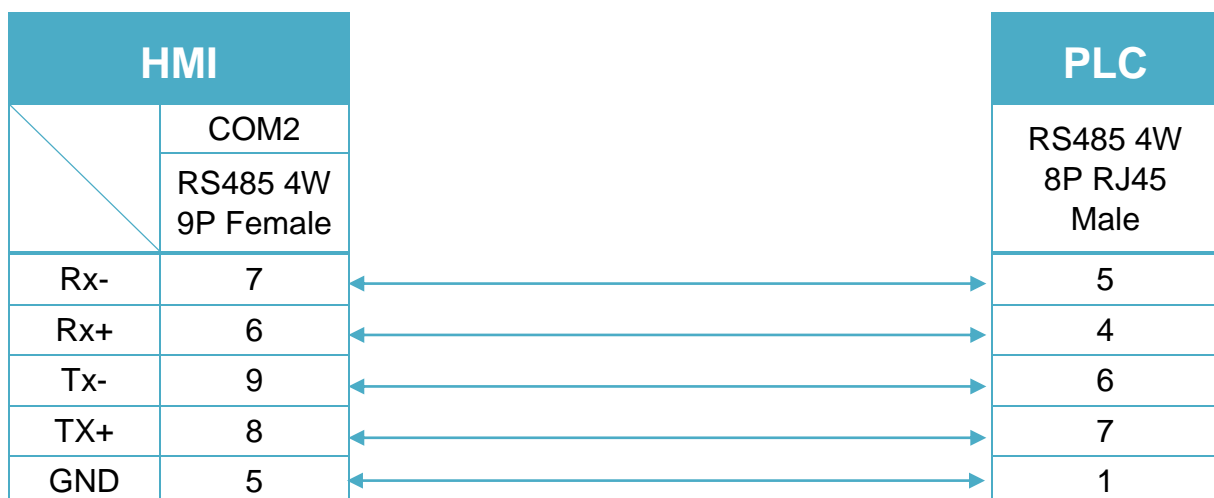


Diagram 6

MT-iE	<i>MT8071iE / MT6071iE / MT8072iE / MT6072iE / MT8073iE / MT8101iE / MT8102iE / MT8103iE</i>
MT-XE	<i>MT8090XE / MT8092XE</i>
MT-iP	<i>MT6071iP / MT8071iP / MT6103iP</i>

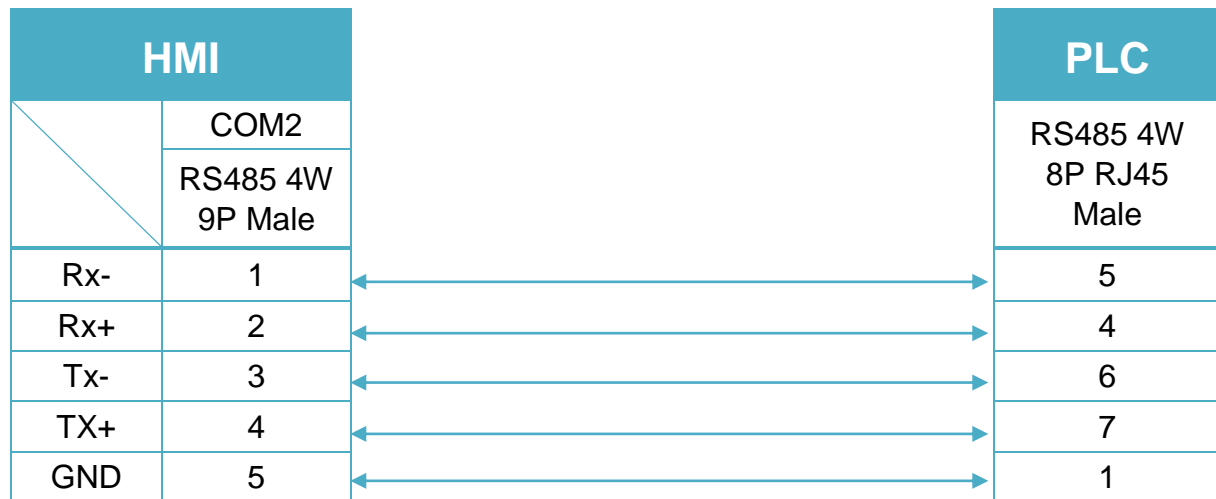
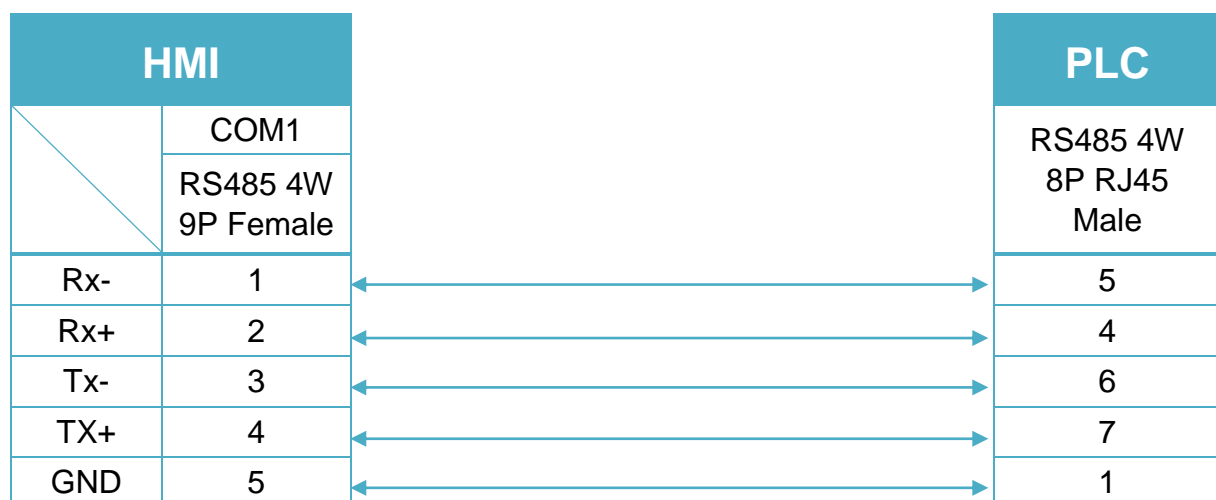


Diagram 7

MT-iE	<i>MT8050iE</i>
MT-iP	<i>MT6051iP</i>



EH-150 port1 RS485 2W (Diagram 8 ~ Diagram 13)

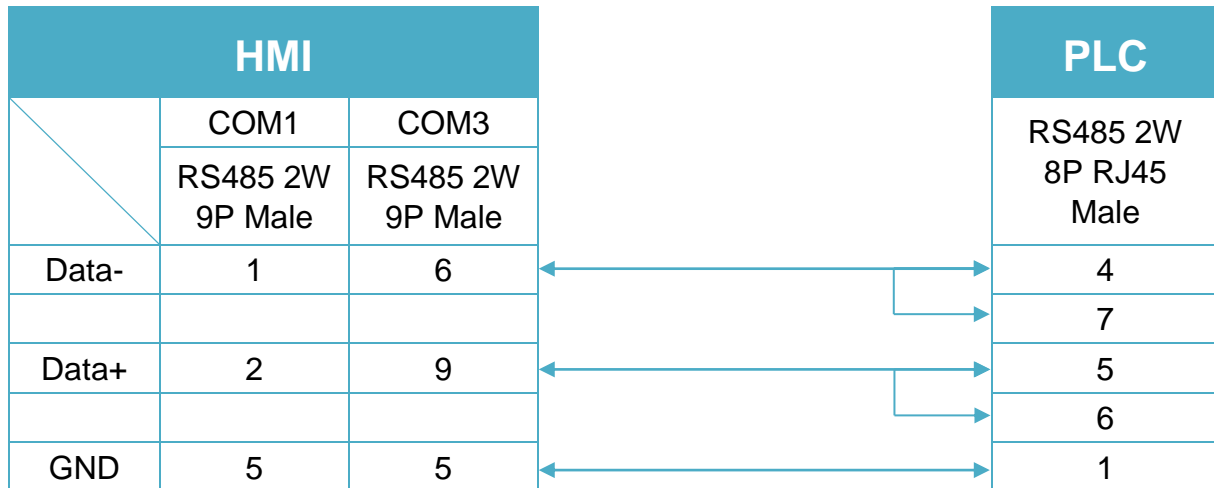
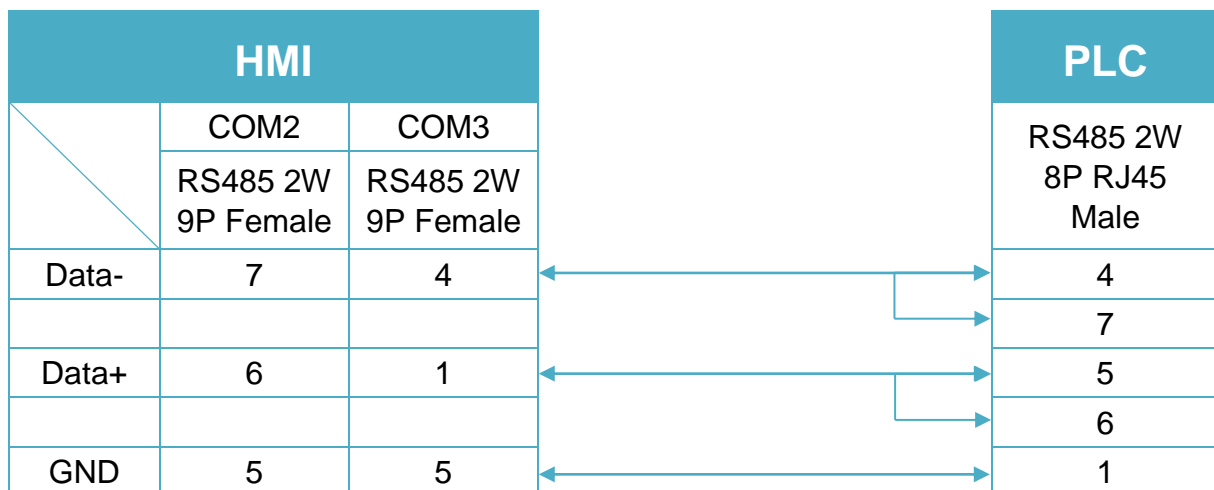
Diagram 8
cMT Series
cMT3151
eMT Series
eMT3070/ eMT3105 / eMT3120 / eMT3150

Diagram 9
cMT Series
cMT-SVR
mTV
mTV


Diagram 10

MT-iE *MT8070iE / MT6070iE / MT8100iE / MT8121iE / MT8150iE*

MT-XE *MT8121XE / MT8150XE*

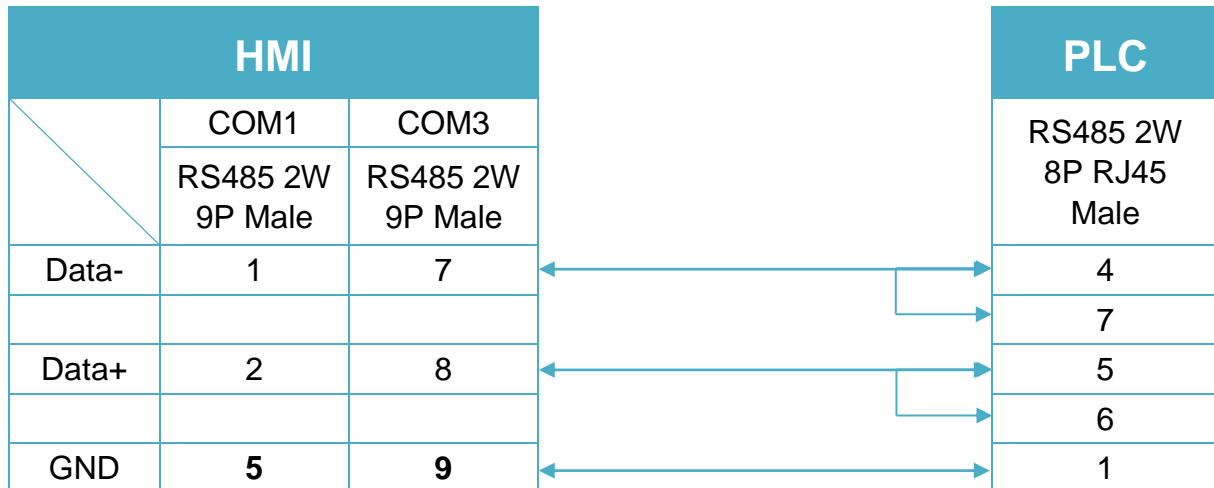


Diagram 11

MT-iE *MT8071iE / MT6071iE / MT8072iE / MT6072iE / MT8073iE /
MT8101iE / MT8102iE / MT8103iE*

MT-XE *MT8090XE / MT8092XE*

MT-iP *MT6103iP*

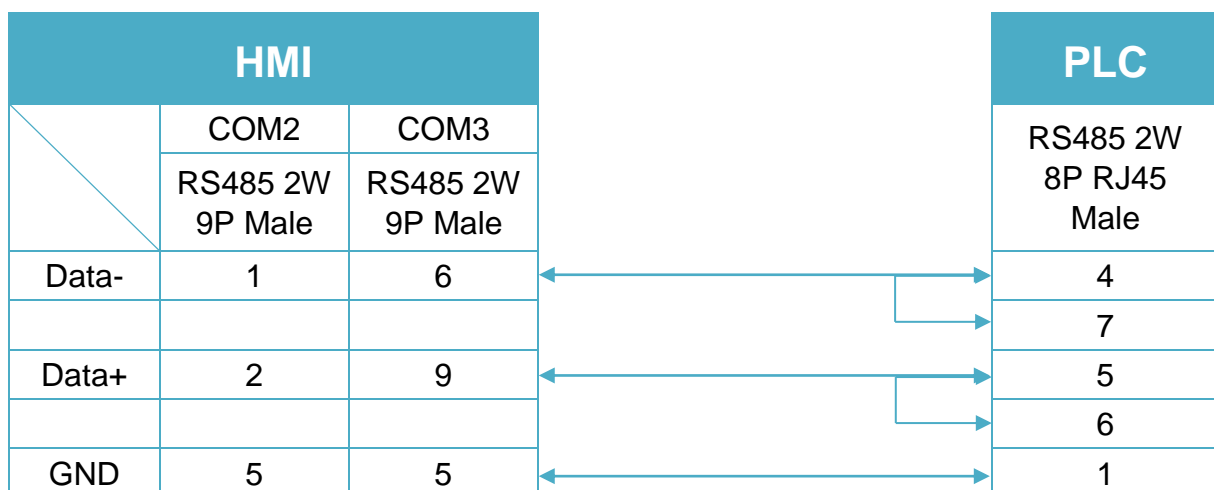


Diagram 12

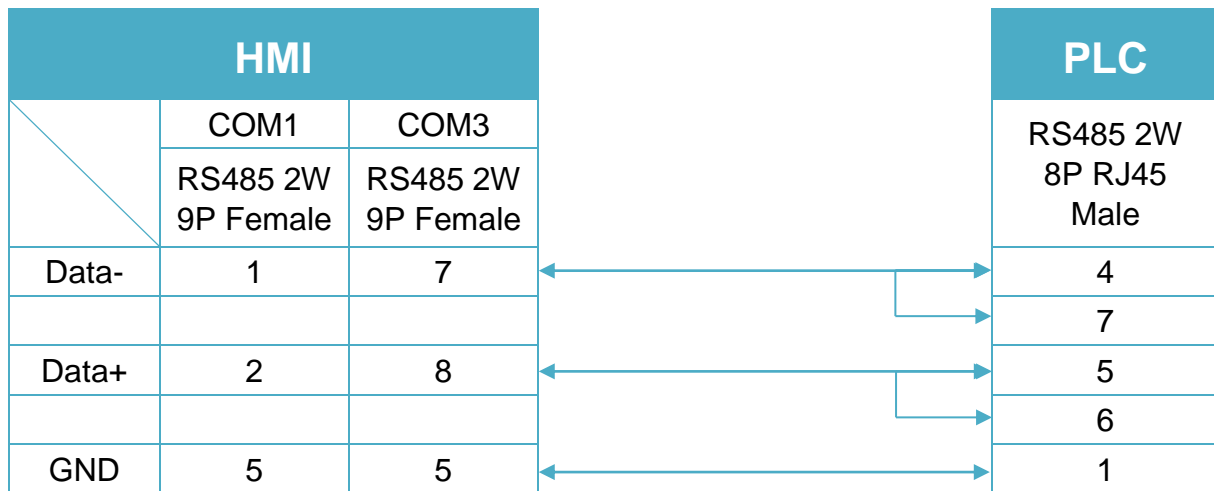
MT-iE *MT8050iE*
MT-iP *MT6051iP*


Diagram 13

MT-iP *MT6071iP / MT8071iP*


H Series CPU Port RS232 (Diagram 14~ Diagram 16)

Diagram 14

cMT Series	<i>cMT3151</i>
eMT Series	<i>eMT3070 / eMT3105 / eMT3120 / eMT3150</i>
MT-iE	<i>MT8073iE / MT8102iE</i>
MT-XE	<i>MT8092XE</i>
MT-iP	<i>MT6103iP</i>

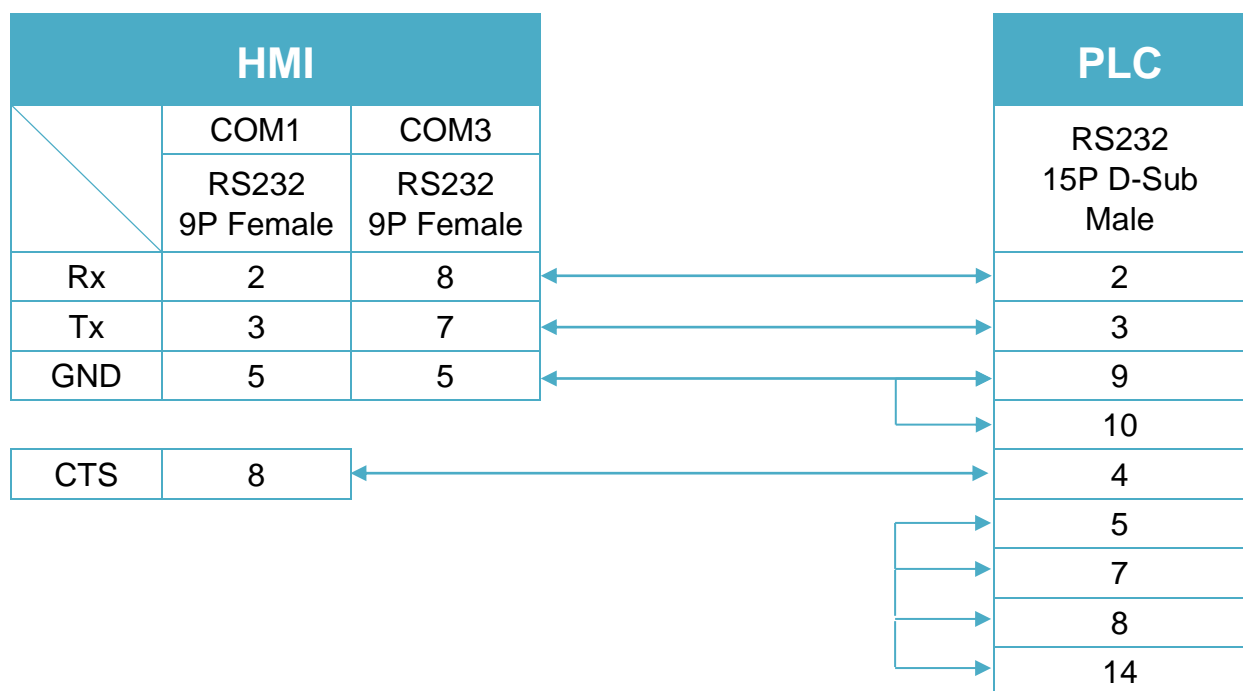


Diagram 15

cMT Series	cMT-SVR
mTV	mTV
MT-iE	MT8070iE / MT6070iE / MT8100iE / MT8121iE / MT8150iE / MT8071iE / MT6071iE / MT8072iE / MT6072iE / MT8073iE / MT8101iE / MT8102iE / MT8103iE
MT-XE	MT8121XE / MT8150XE / MT8090XE

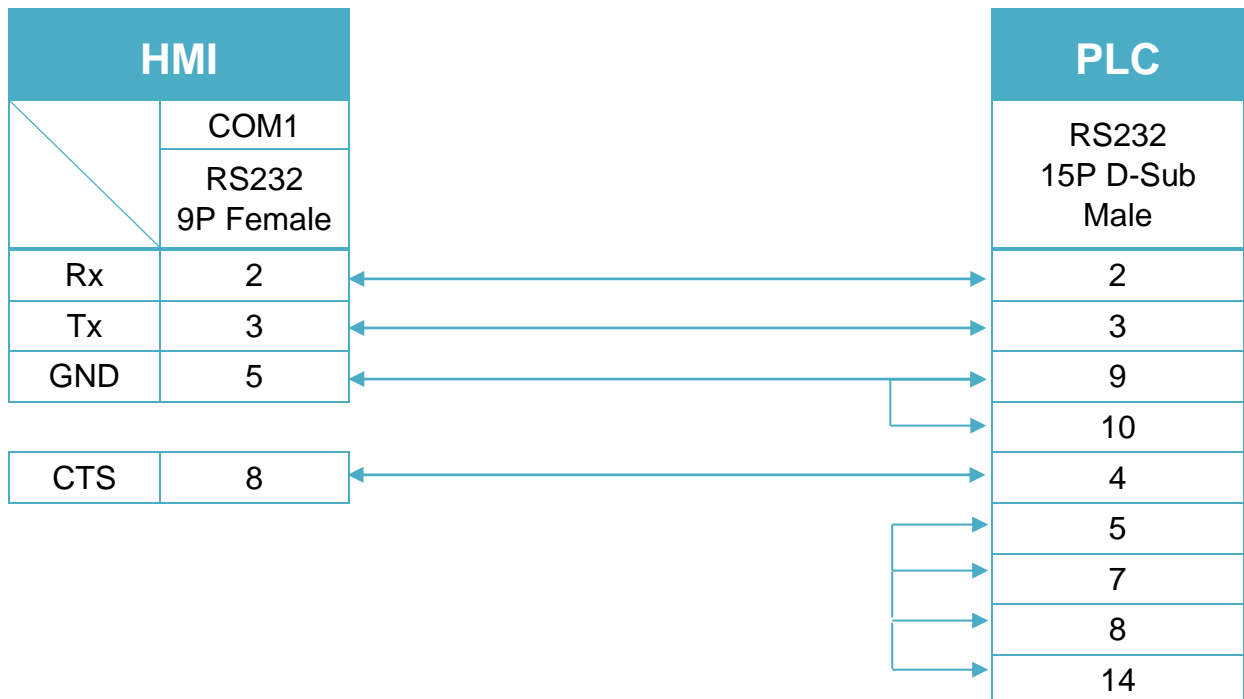
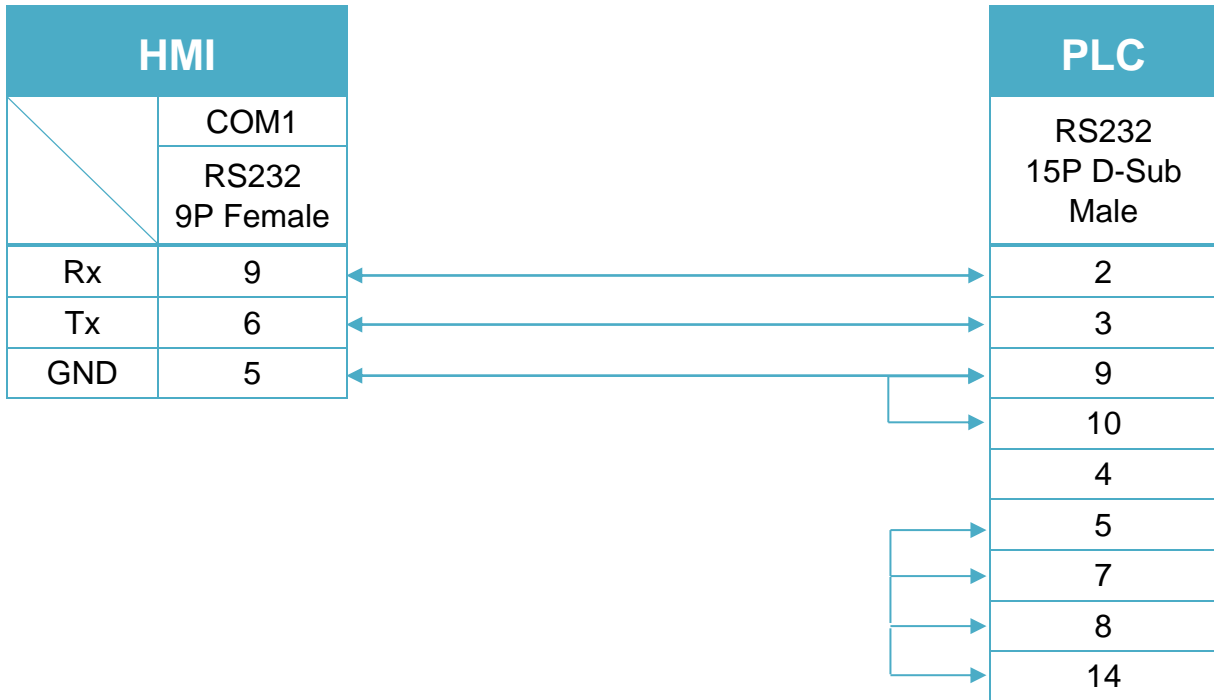


Diagram 16
MT-iE
MT8050iE
MT-iP
MT6051iP / MT6071iP / MT8071iP


HollySys LE/LM PLC

Supported Series: HollySys LE/LM series PLC

Website: <http://www.hollysys.com/>

HMI Setting:

Parameters	Recommended	Options	Notes
PLC type	HollySys LE/LM PLC		
PLC I/F	RS485 2W		
Baud rate	38400		
Data bits	8		
Parity	None		
Stop bits	1		
PLC sta. no.	1		

Device Address:

Bit/Word	Device type	Format	Range	Memo
B	%IX	DDDDo	0 ~ 81907	
B	%MX	DDDDo	0 ~ 81907	
B	%QX	DDDDo	0 ~ 81907	
W	%IW	DDDD	0 ~ 8190	
W	%QW	DDDD	0 ~ 8190	
W	%MW	DDDD	0 ~ 8190	
W	%MD	DDDD	0 ~ 8190	
W	%MR	DDDD	0 ~ 8190	

Wiring Diagram:

The following is the view from the soldering point of a connector.



Diagram 1

cMT Series *cMT3151*

eMT Series *eMT3070 / eMT3105 / eMT3120 / eMT3150*

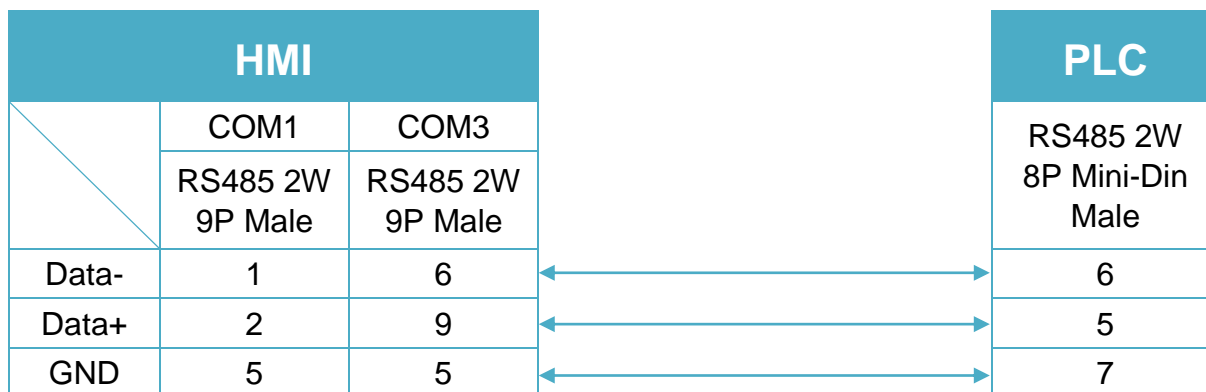


Diagram 2

cMT Series *cMT-SVR*

mTV *mTV*

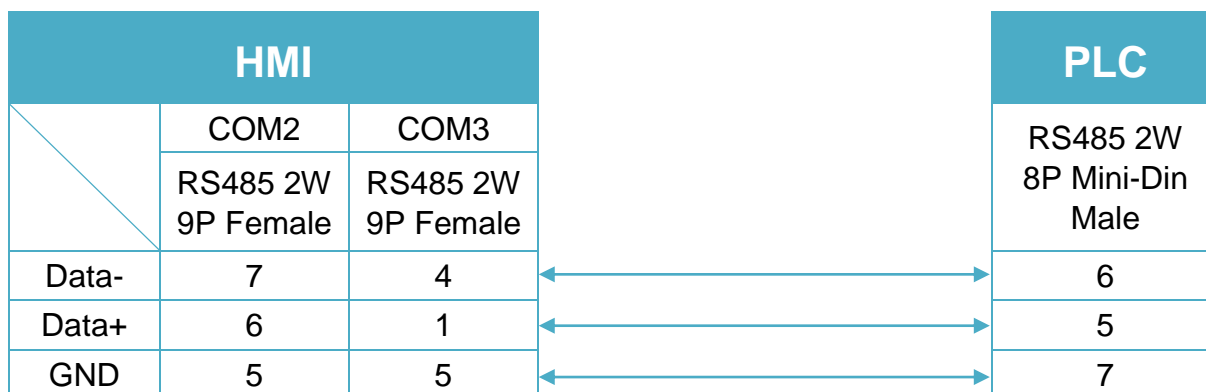


Diagram 3

MT-iE *MT8070iE / MT6070iE / MT8100iE / MT8121iE / MT8150iE*

MT-XE *MT8121XE / MT8150XE*

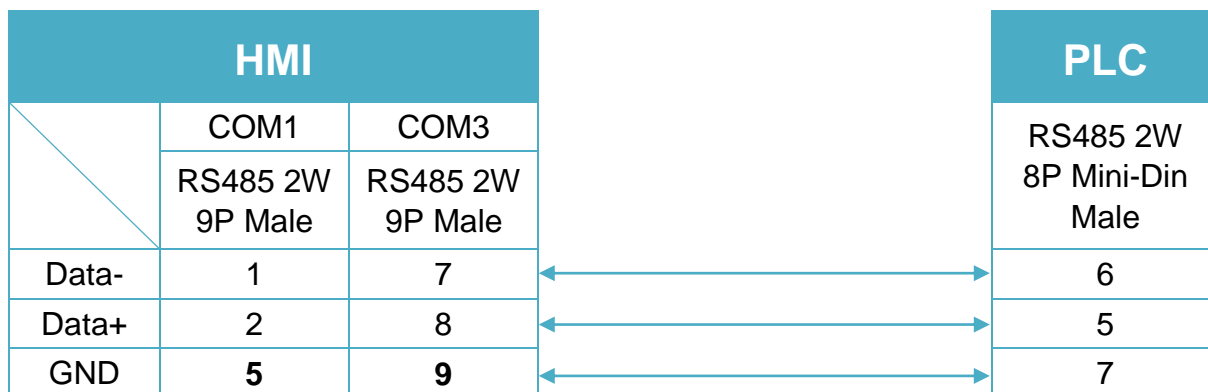


Diagram 4

MT-iE *MT8071iE / MT6071iE / MT8072iE / MT6072iE / MT8073iE /
MT8101iE / MT8102iE / MT8103iE*

MT-XE *MT8090XE / MT8092XE*

MT-iP *MT6103iP*

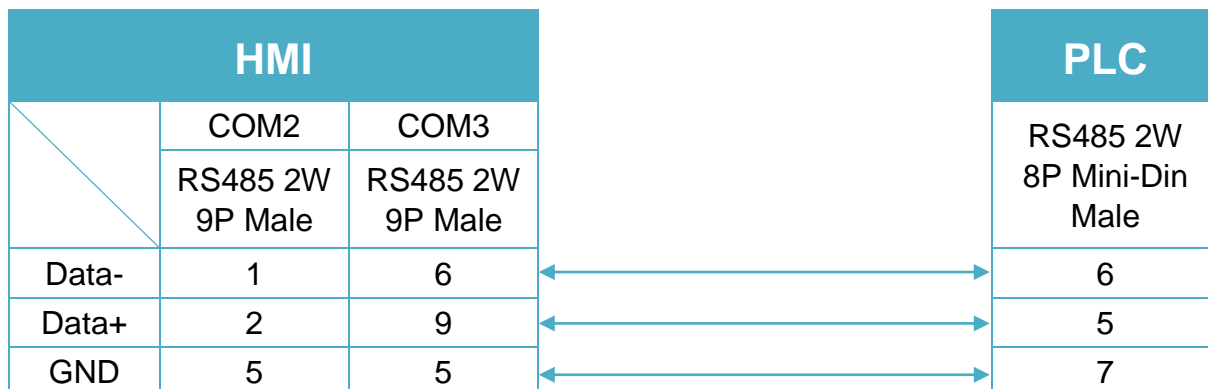
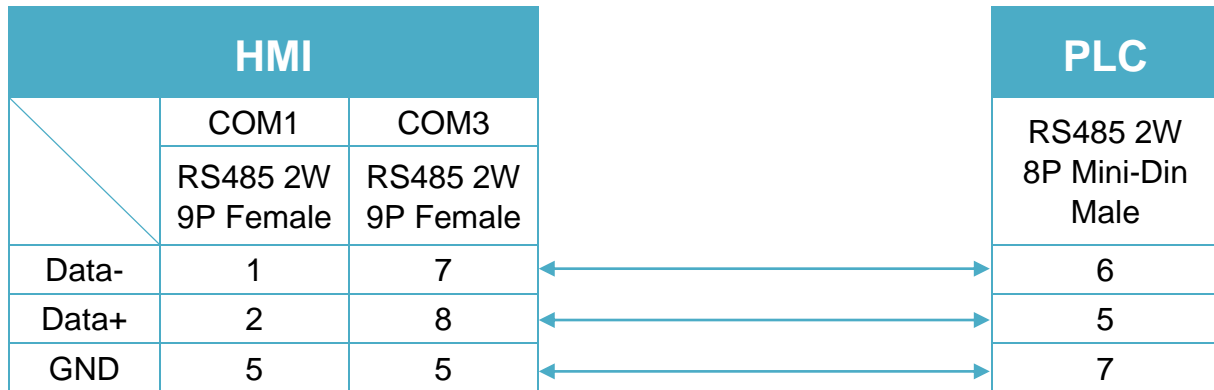
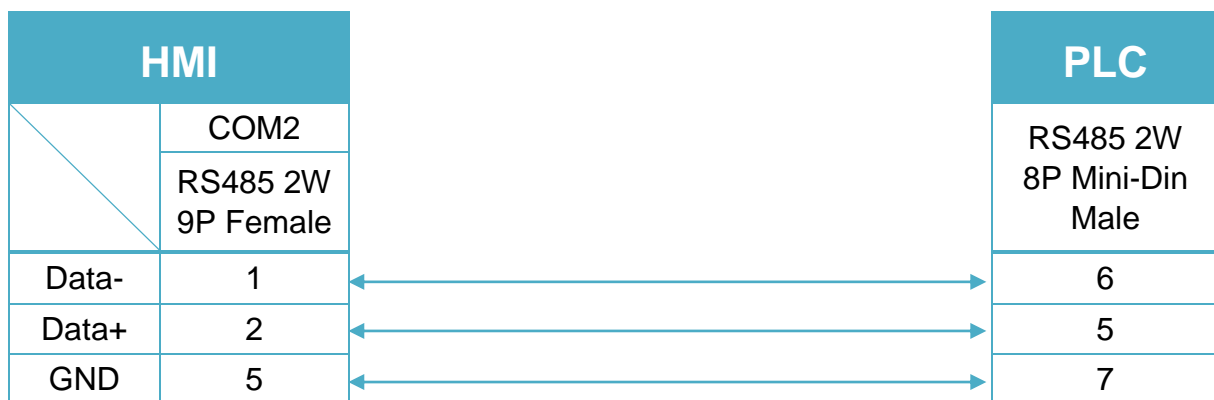


Diagram 5
MT-iE *MT8050iE*
MT-iP *MT6051iP*

Diagram 6
MT-iP *MT6071iP / MT8071iP*


HUST H4C

Supported Series: HUST CNC Controller H4C, H6C Series.

Website: <http://www.hust.com.tw/>

HMI Setting:

Parameters	Recommended	Options	Notes
PLC type	HUST H4C		
PLC I/F	RS-232		CPU port
Baud rate	38400	9600,19200,38400,57600	
Data bits	7		
Parity	Even		
Stop bits	2		
Turn around	5		
PLC sta. no.	1		

Device Address:

Bit/Word	Device type	Format	Range	Memo
B	I	DDD	0 ~ 255	Mapping to VM 10800 ~ 10807 (read only)
B	O	DDD	0 ~ 255	Mapping to VM 10808 ~ 10815 (read only)
B	C	DDD	0 ~ 255	Mapping to VM 10816 ~ 10823 (read only)
B	S	DDD	0 ~ 255	Mapping to VM 10824 ~ 10831 (read only)
B	A	DDD	0 ~ 1023	Mapping to VM 10832 ~ 10863 (read only)
B	VM_bit	DDDDdd	0 ~ 9999931	Bit address (dd): 00 ~ 31
DW	VM	DDDDD	0 ~ 99999	Please refer to the controller specification for register range.
DW	R	DDD	0 ~ 255	Mapping to VM 10000 ~ 10255 (read only)
DW	Cn	DDD	0 ~ 255	Mapping to VM 10256 ~ 10511 (read only)
DW	Tm	DDD	0 ~ 255	Mapping to VM 10512 ~ 10767 (read only)

Wiring Diagram:

HUST CNC Controller

Diagram 1

cMT Series	<i>cMT3151</i>
eMT Series	<i>eMT3070 / eMT3105 / eMT3120 / eMT3150</i>
MT-iE	<i>MT8073iE / MT8102iE</i>
MT-XE	<i>MT8092XE</i>
MT-iP	<i>MT6103iP</i>

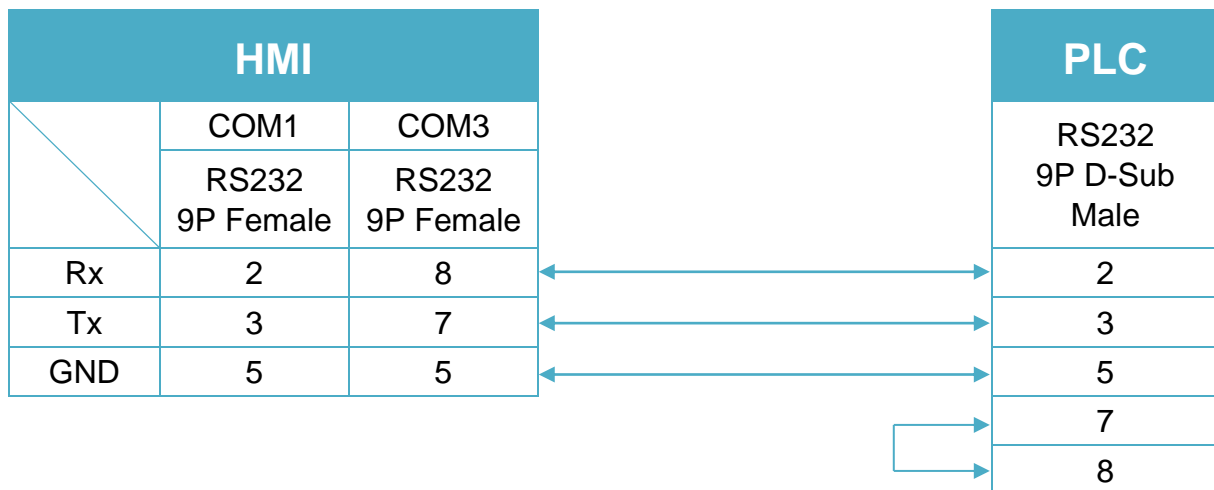


Diagram 2

cMT Series	cMT-SVR
mTV	mTV
MT-iE	MT8070iE / MT6070iE / MT8100iE / MT8121iE / MT8150iE / MT8071iE / MT6071iE / MT8072iE / MT6072iE / MT8073iE / MT8101iE / MT8102iE / MT8103iE
MT-XE	MT8121XE / MT8150XE / MT8090XE /

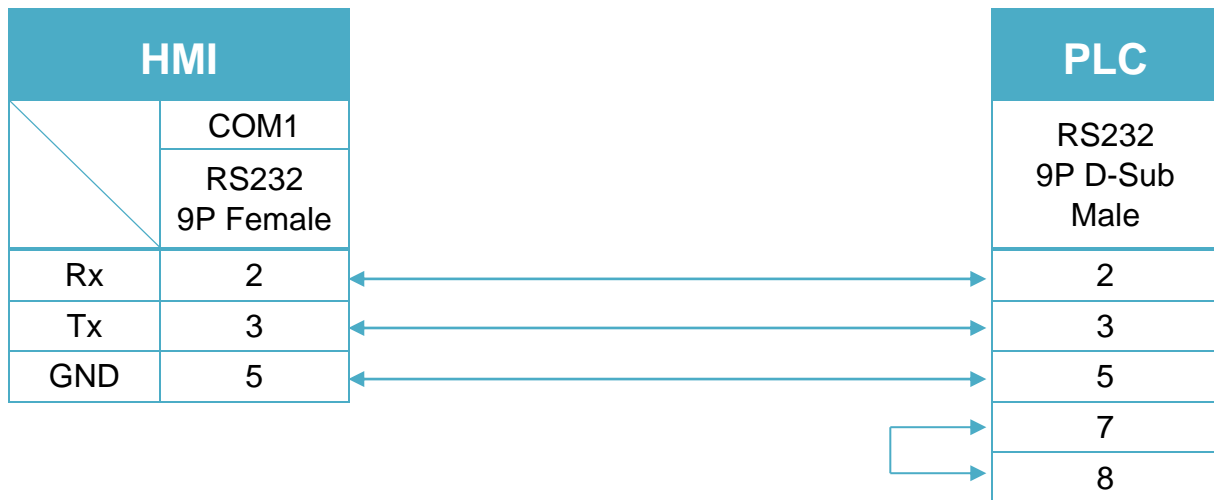
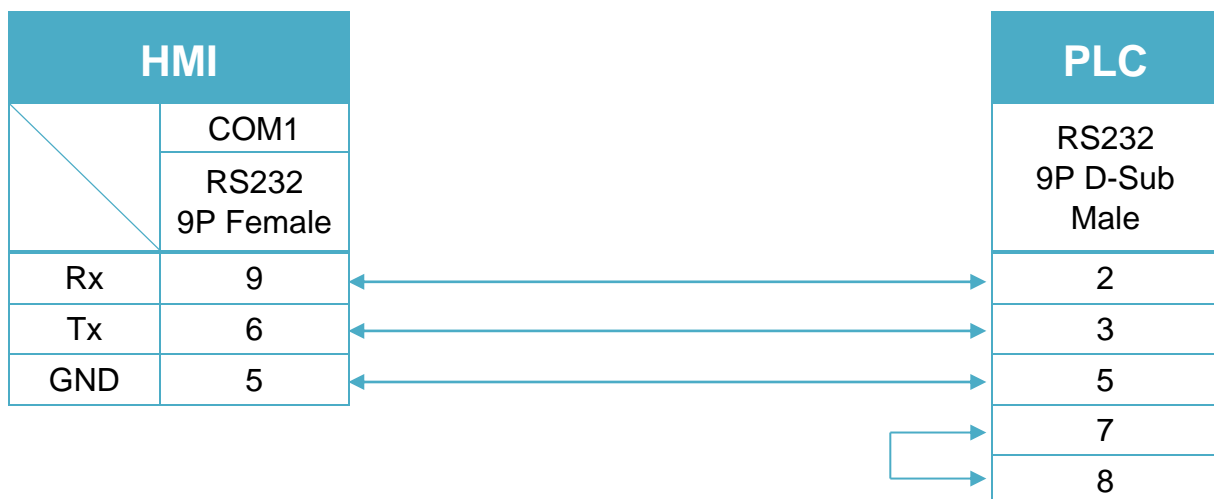


Diagram 3

MT-iE	MT8050iE
MT-iP	MT6051iP / MT6071iP / MT8071iP



HUST H4X

Supported Series: HUST CNC Controller H4 Series.

Website: <http://www.hust.com.tw/>

HMI Setting:

Parameters	Recommended	Options	Notes
PLC type	HUST H4X		
PLC I/F	RS-232		CPU port
Baud rate	38400	9600,19200,38400,57600	
Data bits	7		
Parity	Even		
Stop bits	2		
Turn around	5		
PLC sta. no.	1		

Device Address:

Bit/Word	Device type	Format	Range	Memo
B	I	DDD	0 ~ 255	Mapping to VM 10800 ~ 10807 (read only)
B	O	DDD	0 ~ 255	Mapping to VM 10808 ~ 10815 (read only)
B	C	DDD	0 ~ 255	Mapping to VM 10816 ~ 10823 (read only)
B	S	DDD	0 ~ 255	Mapping to VM 10824 ~ 10831 (read only)
B	A	DDD	0 ~ 255	Mapping to VM 10832 ~ 10863 (read only)
B	VM_bit	DDDDDDdd	100 ~ 9999931	Bit address (dd): 00 ~ 31
DW	VM	DDDDD	1 ~ 99999	Please refer to the controller specification for register range.
DW	R	DDD	0 ~ 255	Mapping to VM 10000 ~ 10255 (read only)
DW	Cn	DDD	0 ~ 255	Mapping to VM 10256 ~ 10511 (read only)
DW	Tm	DDD	0 ~ 255	Mapping to VM 10512 ~ 10767 (read only)

Wiring Diagram:

Diagram 1

cMT Series	<i>cMT3151</i>
eMT Series	<i>eMT3070 / eMT3105 / eMT3120 / eMT3150</i>
MT-iE	<i>MT8073iE / MT8102iE</i>
MT-XE	<i>MT8092XE</i>
MT-iP	<i>MT6103iP</i>

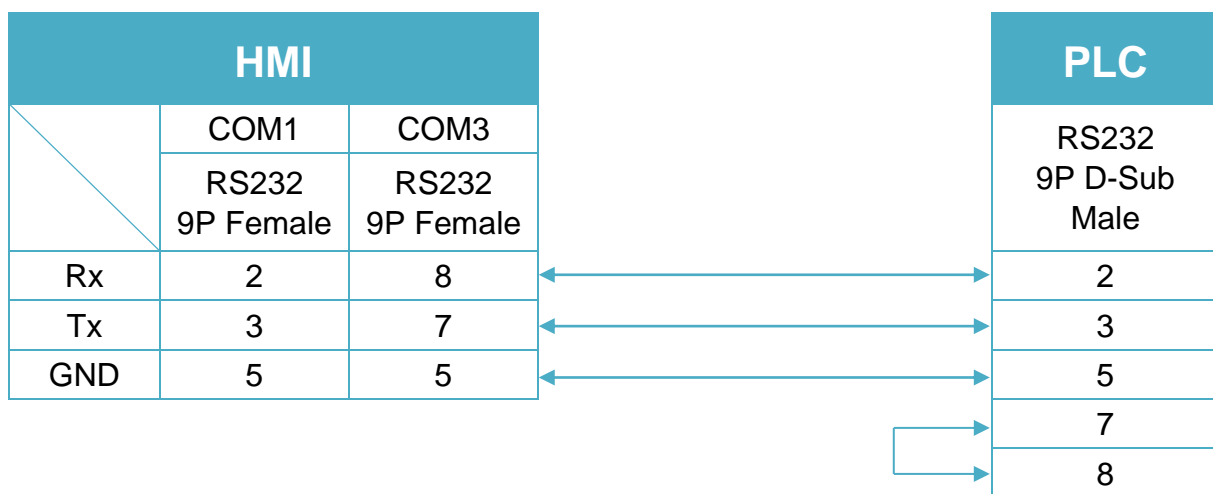


Diagram 2

cMT Series	cMT-SVR
mTV	mTV
MT-iE	MT8070iE / MT6070iE / MT8100iE / MT8121iE / MT8150iE / MT8071iE / MT6071iE / MT8072iE / MT6072iE / MT8073iE / MT8101iE / MT8102iE / MT8103iE
MT-XE	MT8121XE / MT8150XE / MT8090XE /

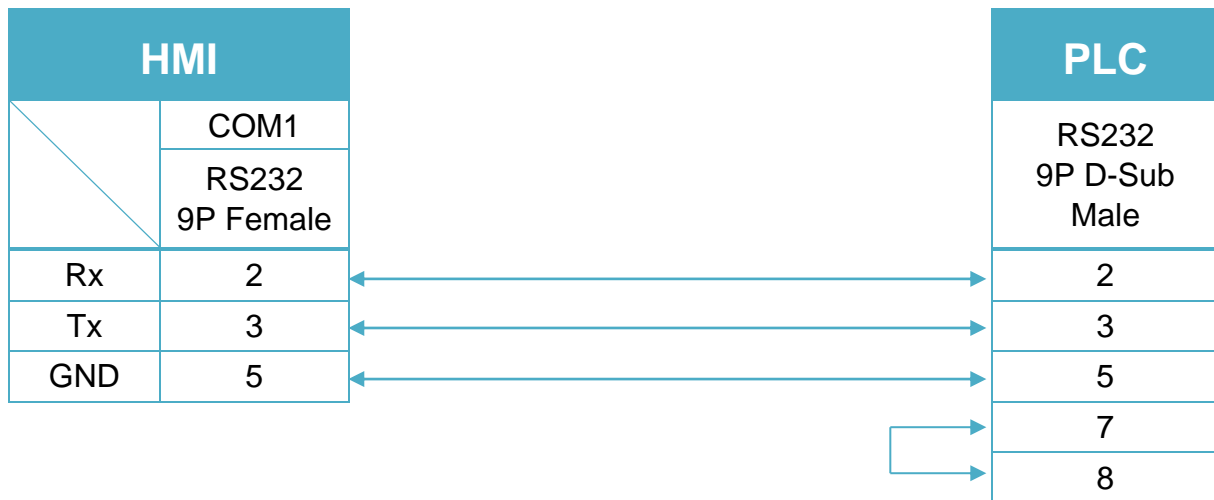
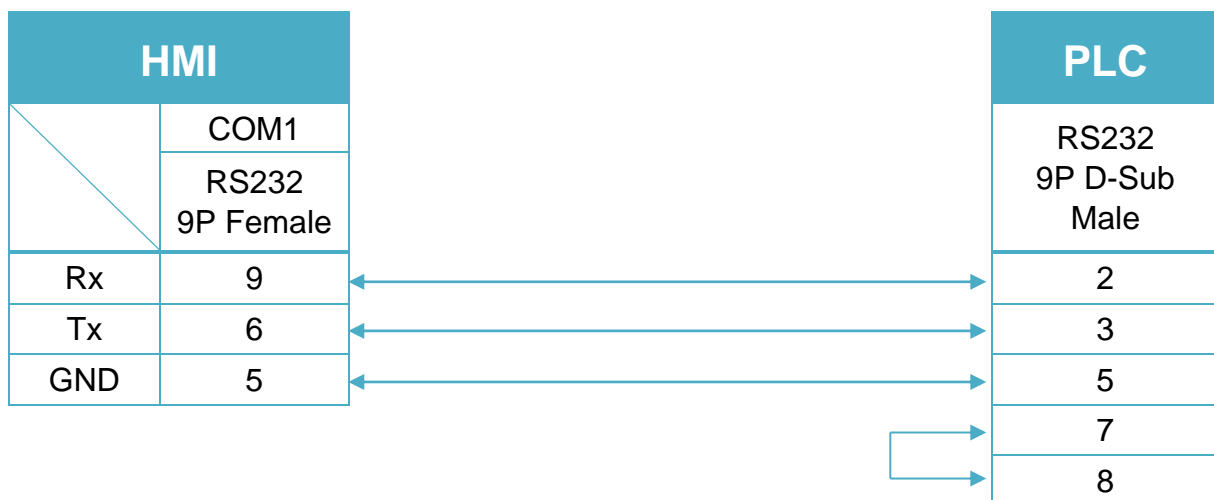


Diagram 3

MT-iE	MT8050iE
MT-iP	MT6051iP / MT6071iP / MT8071iP



IAI PCON-C-42PI

Supported Series: PCON Controller for RCP2 Series.

Website: <http://www.intelligentactuator.com>

HMI Setting:

Parameters	Recommended	Options	Notes
PLC type	IAI PCON-C-42PI		
PLC I/F	RS485 2W		
Baud rate	9600	9600 ~ 115200	
Data bits	8		
Parity	None		
Stop bits	1		
PLC sta. no.	1	1 ~ 16	

Device Address:

Bit/Word	Device type	Format	Range	Memo
B	SFTY	D	1	
B	SON	D	1	
B	ALRS	D	1	
B	BKRL	D	1	
B	STP	D	1	
B	HOME	D	1	
B	CSTR	D	1	
B	JISL	D	1	
B	MOD	D	1	
B	TEAC	D	1	
B	JOG+	D	1	
B	JOG-	D	1	
B	ST0	D	1	
B	ST1	D	1	
B	ST2	D	1	
B	ST3	D	1	
B	ST4	D	1	
B	ST5	D	1	
B	ST6	D	1	

Bit/Word	Device type	Format	Range	Memo
B	ST7	D	1	
B	PMSL	D	1	
B	STOP	D	1	
B	CLBR	D	1	
B	DSS1_Bit	Ddd	15	EMGS
B	DSS1_Bit	Ddd	14	SFTY
B	DSS1_Bit	Ddd	13	PWR
B	DSS1_Bit	Ddd	12	SV
B	DSS1_Bit	Ddd	11	PSFL
B	DSS1_Bit	Ddd	10	ALMH
B	DSS1_Bit	Ddd	9	ALML
B	DSS1_Bit	Ddd	8	ABER
B	DSS1_Bit	Ddd	7	BKRL
B	DSS1_Bit	Ddd	5	STP
B	DSS1_Bit	Ddd	4	HEND
B	DSS1_Bit	Ddd	3	PEND
B	DSS1_Bit	Ddd	2	CEND
B	DSS1_Bit	Ddd	1	CLBS
B	DSS2_Bit	Ddd	15	ENBS
B	DSS2_Bit	Ddd	13	LOAD
B	DSS2_Bit	Ddd	12	TRQS
B	DSS2_Bit	Ddd	11	MODS
B	DSS2_Bit	Ddd	10	TEAC
B	DSS2_Bit	Ddd	9	JOG+
B	DSS2_Bit	Ddd	8	JOG-
B	DSS2_Bit	Ddd	7	PE7
B	DSS2_Bit	Ddd	6	PE6
B	DSS2_Bit	Ddd	5	PE5
B	DSS2_Bit	Ddd	4	PE4
B	DSS2_Bit	Ddd	3	PE3
B	DSS2_Bit	Ddd	2	PE2
B	DSS2_Bit	Ddd	1	PE1
B	DSS2_Bit	Ddd	0	PE0
B	DSSE_Bit	Ddd	15	EMGP
B	DSSE_Bit	Ddd	14	MPUV
B	DSSE_Bit	Ddd	13	RMDS
B	DSSE_Bit	Ddd	11	GHMS

Bit/Word	Device type	Format	Range	Memo
B	DSSE_Bit	Ddd	10	PUSH
B	DSSE_Bit	Ddd	9	PSNS
B	DSSE_Bit	Ddd	8	PMSS
B	DSSE_Bit	Ddd	5	MOVE
B	POSS_Bit	Ddd	9	PM512
B	POSS_Bit	Ddd	8	PM256
B	POSS_Bit	Ddd	7	PM128
B	POSS_Bit	Ddd	6	PM64
B	POSS_Bit	Ddd	5	PM32
B	POSS_Bit	Ddd	4	PM16
B	POSS_Bit	Ddd	3	PM8
B	POSS_Bit	Ddd	2	PM4
B	POSS_Bit	Ddd	1	PM2
B	POSS_Bit	Ddd	0	PM1
B	ZONS_Bit	Ddd	14	LS2
B	ZONS_Bit	Ddd	13	LS1
B	ZONS_Bit	Ddd	12	LS0
B	ZONS_Bit	Ddd	8	ZP
B	ZONS_Bit	Ddd	1	Z2
B	ZONS_Bit	Ddd	0	Z1
B	DIPM_Bit	Ddd	0 ~ 15	IN0 ~ IN15
B	DOPM_Bit	Ddd	0 ~ 15	OUT0 ~ OUT15
B	SIPM_Bit	Ddd	14	NP
B	SIPM_Bit	Ddd	12	PP
B	SIPM_Bit	Ddd	8	MDSW
B	SIPM_Bit	Ddd	4	BLCT
B	SIPM_Bit	Ddd	3	HMCK
B	SIPM_Bit	Ddd	2	OT
B	SIPM_Bit	Ddd	1	CREP
B	SIPM_Bit	Ddd	0	LS
B	EMG	D	1	
B	POSR_Bit	Ddd	0 ~ 15	
W	PNOW	D	1	
W	ALMC	D	1	
W	DIPM	D	1	
W	DOPM	D	1	
W	DSS1	D	1	

Bit/Word	Device type	Format	Range	Memo
W	DSS2	D	1	
W	DSSE	D	1	
W	STAT	D	1	
W	VNOW	D	1	
W	CNOW	D	1	
W	DEVI	D	1	
W	STIM	D	1	
W	SIPM	D	1	
W	ZONS	D	1	
W	POSS	D	1	
W	DRG1	D	1	
W	DRG2	D	1	
W	POSR_NUM	D	1	
W	PCMD	D	1	
W	INP	D	1	
W	VCMD	D	1	
W	ACMD	D	1	
W	PPOW	D	1	
W	CTLF	D	1	
W	FBFC	D	1	
W	POSR_MOV	D	1	
W	PCMD_T	DDD	0 ~ 768	
W	INP_T	DDD	0 ~ 768	
W	VCMD_T	DDD	0 ~ 768	
W	ZNMP_T	DDD	0 ~ 768	
W	ZNLP_T	DDD	0 ~ 768	
W	ACMD_T	DDD	0 ~ 768	
W	DCMD_T	DDD	0 ~ 768	
W	PPOW_T	DDD	0 ~ 768	
W	LPOW_T	DDD	0 ~ 768	
W	CTLF_T	DDD	0 ~ 768	

Wiring Diagram:

The following is the view from the soldering point of a connector.



Diagram 1

cMT Series *cMT3151*

eMT Series *eMT3070 / eMT3105 / eMT3120 / eMT3150*

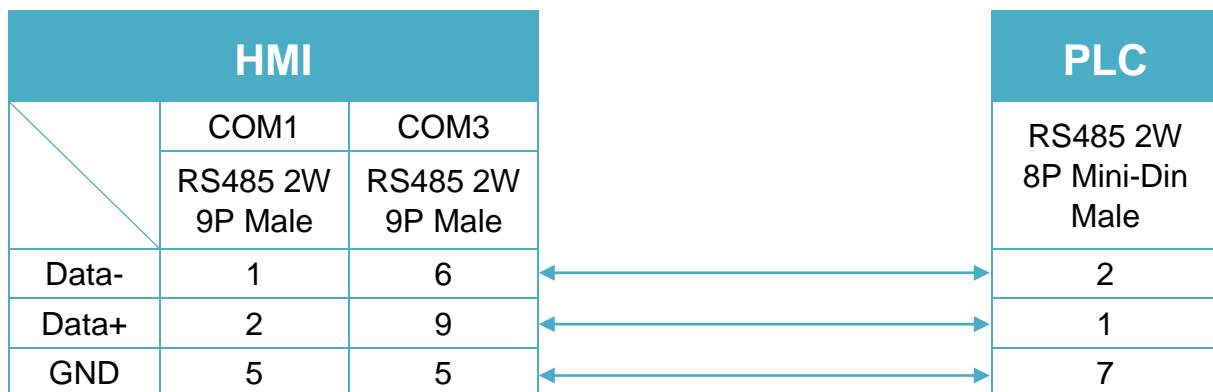


Diagram 2

cMT Series *cMT-SVR*

mTV *mTV*

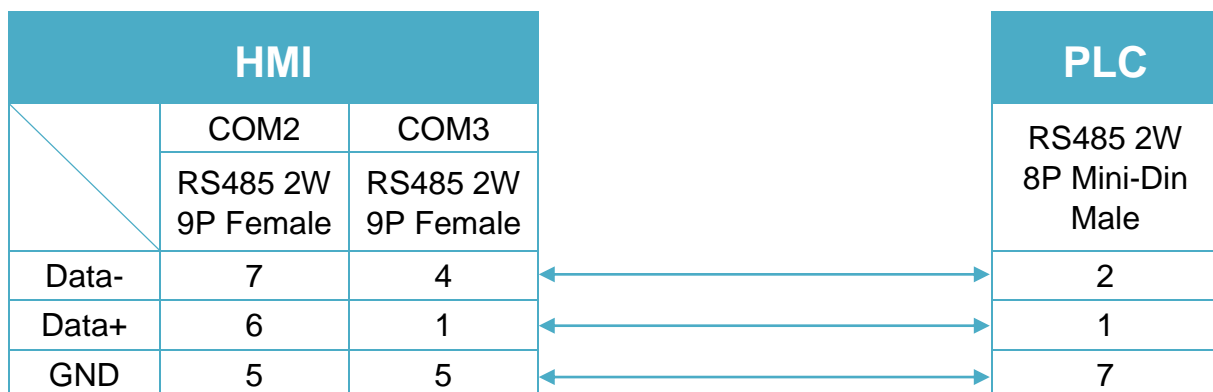


Diagram 3

MT-iE *MT8070iE / MT6070iE / MT8100iE / MT8121iE / MT8150iE*

MT-XE *MT8121XE / MT8150XE*

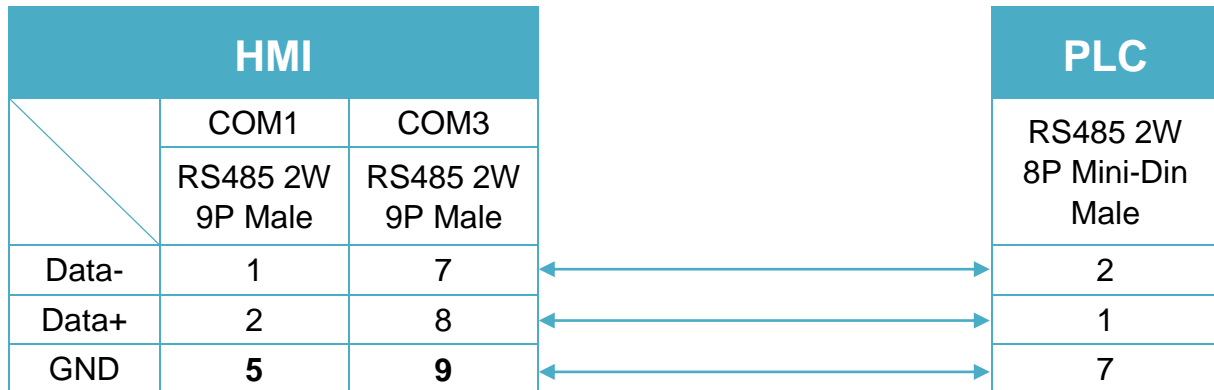


Diagram 4

MT-iE *MT8071iE / MT6071iE / MT8072iE / MT6072iE / MT8073iE /
MT8101iE / MT8102iE / MT8103iE*

MT-XE *MT8090XE / MT8092XE*

MT-iP *MT6103iP*

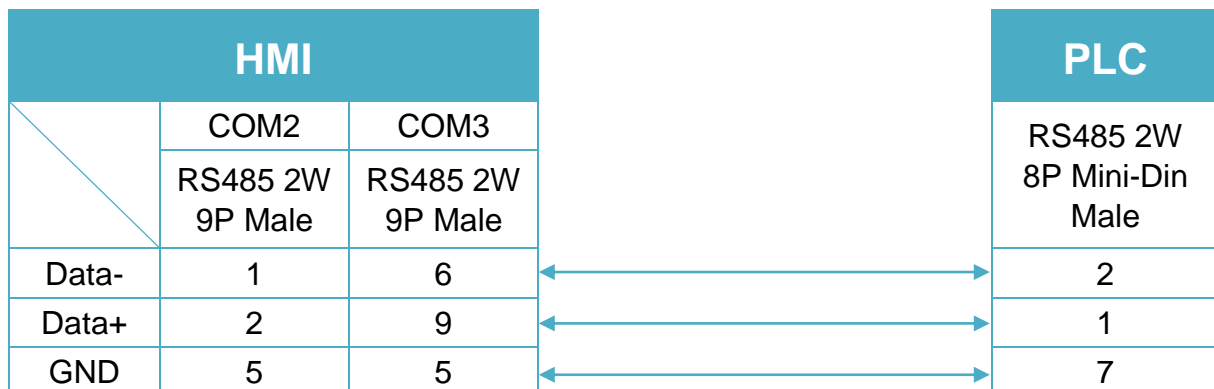


Diagram 5

MT-iE *MT8050iE*

MT-iP *MT6051iP*

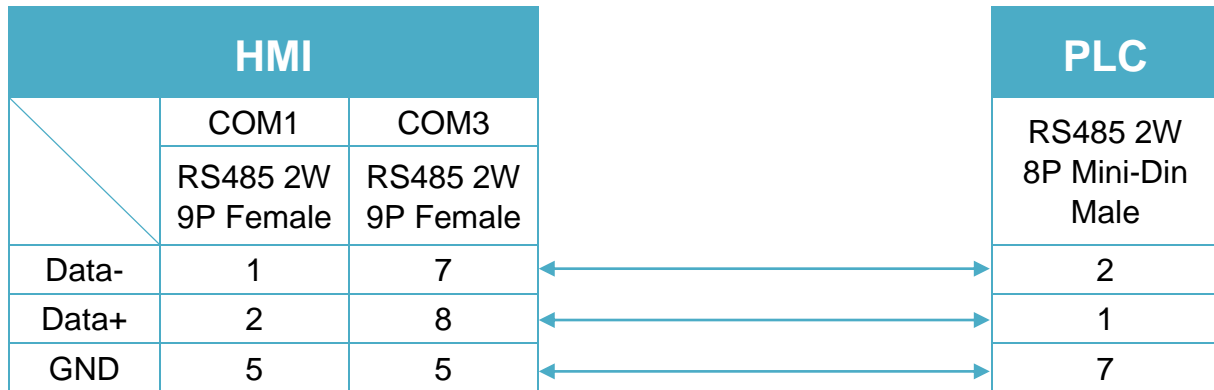
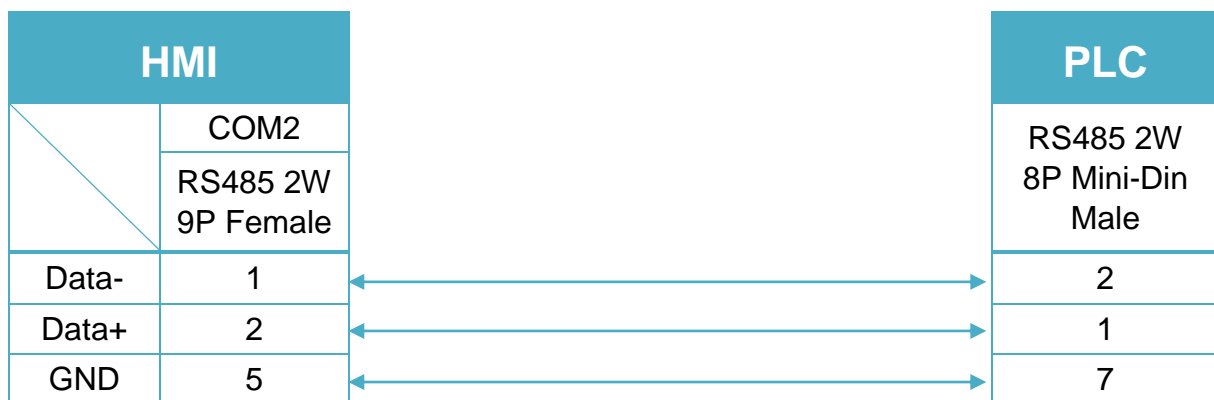


Diagram 6

MT-iP *MT6071iP / MT8071iP*



IAI X-SEL CONTROLLER

Website: <http://www.iai-robot.co.jp/>

HMI Setting:

Parameters	Recommended	Options	Notes
PLC type	IAI X-SEL CONTROLLER		
PLC I/F	RS232		
Baud rate	9600	9600~19200	
Data bits	8	7 or 8	
Parity	None	Even, Odd, None	
Stop bits	1	1 or 2	
PLC sta. no.	0		

Device Address:

Bit/Word	Device type	Format	Range	Memo
W	Servo_On_Off	H	1 ~ 8	Address 1~8 represent the corresponding axis. Write 1 means ON and 0 means OFF.
W	Servo_Origin	H	1 ~ 8	Address 1~8 represent the corresponding axis. Back to origin.
W	CurrentAxisPos	H	1 ~ 8	For reading current position. The state of current axis is put in RW axis*100. i.e., for the state of axis 2, 2*100=200, so it is in RW200.
W	RunProgram	H	0	Data written indicates which program to run.
W	EndProgram	H	0	Data written indicates which program to stop.
W	PointMove	H	0 ~ 8	Address 1~8 represent the corresponding axis. The data written indicates which point to reach. Put parameters ACC, DEC, SPEED in axis*100+1, axis*100+2 and axis*100+3 respectively.
W	JoggingMove	H	0 ~ 8	Jogging. Address 1~8 represent the

Bit/Word	Device type	Format	Range	Memo
				corresponding axis. Put parameters ACC, DEC, SPEED and Position in axis*100+11, axis*100+12, axis*100+13 and axis*100+14 respectively.
W	AbsoluteMove	H	0 ~ 8	Jog to the set absolute coordinate. Address 1~8 represent the corresponding axis. Put parameters ACC, DEC, SPEED and Position in axis*100+21, axis*100+22, axis*100+23 and axis*100+24 respectively.
W	PointChange	H	0 ~ 8	To change the value of the point. Address 1~8 represent the corresponding axis. Put parameters ACC, DEC, SPEED and Position in axis*100+31, axis*100+32, axis*100+33 and axis*100+34 respectively.
W	SoftWareReset	H	0	Reset soft ware.

Note: ddd: Decimal, hhh: Hexadecimal, ooo: Octal.

Each model of CPU is different; it is recommended to refer to PLC Manual Device List.

Wiring Diagram:

Diagram 1

cMT Series	<i>cMT3151</i>
eMT Series	<i>eMT3070 / eMT3105 / eMT3120 / eMT3150</i>
MT-iE	<i>MT8073iE / MT8102iE</i>
MT-XE	<i>MT8092XE</i>
MT-iP	<i>MT6103iP</i>

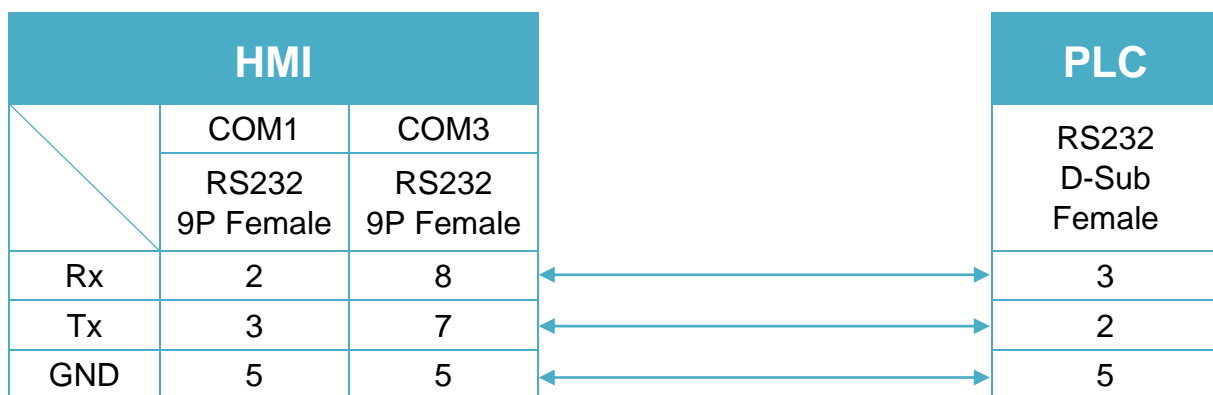


Diagram 2

cMT Series	cMT-SVR
mTV	mTV
MT-iE	MT8070iE / MT6070iE / MT8100iE / MT8121iE / MT8150iE / MT8071iE / MT6071iE / MT8072iE / MT6072iE / MT8073iE / MT8101iE / MT8102iE / MT8103iE
MT-XE	MT8121XE / MT8150XE / MT8090XE

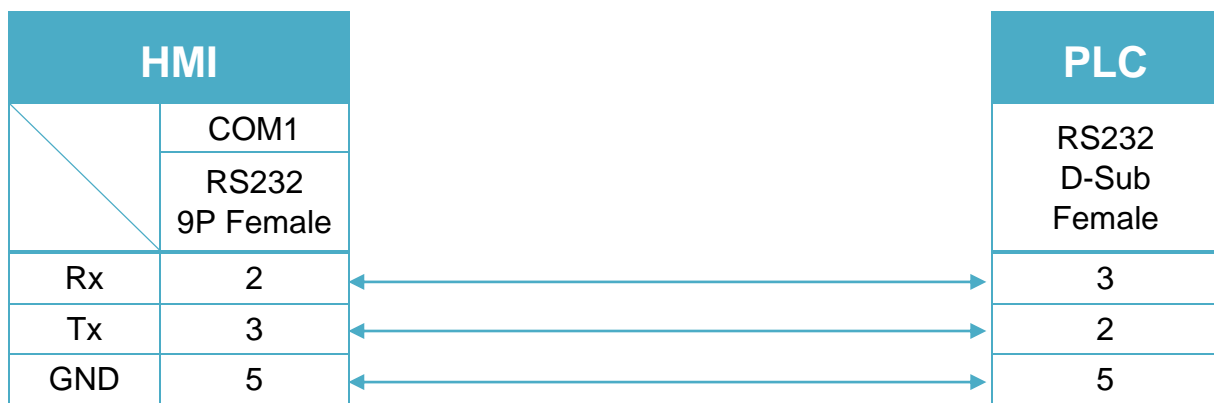
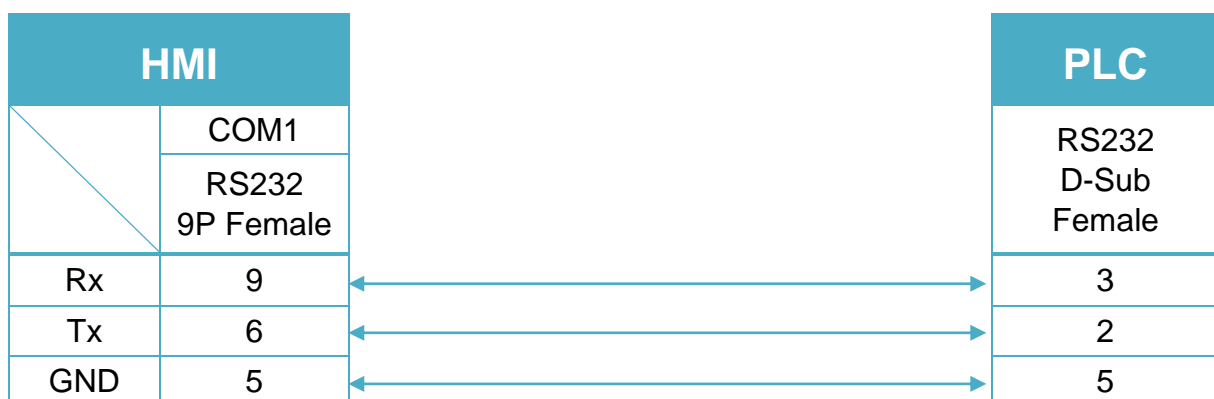


Diagram 3

MT-iE	MT8050iE
MT-iP	MT6051iP / MT6071iP / MT8071iP



IAI X-SEL CONTROLLER-SSE

Website: <http://www.iai-robot.co.jp/>

HMI Setting:

Parameters	Recommended	Options	Notes
PLC type	IAI X-SEL CONTROLLER-SSE		
PLC I/F	RS232		
Baud rate	9600	9600~19200	
Data bits	8	7 or 8	
Parity	None	Even, Odd, None	
Stop bits	1	1 or 2	
PLC sta. no.	0		

Device Address:

Bit/Word	Device type	Format	Range	Memo
B	IP_Bit	DDD	0 ~ 299	
B	OP_Bit	DDDdd	30000 ~ 57215	
B	FG_Bit	DDDDDDdd	0 ~ 12899915	
B	AX1Status	D	0 ~ 8	
B	AX2Status	D	0 ~ 8	
B	AX3Status	D	0 ~ 8	
W	IP	DDD	0 ~ 272	
W	OP	DDD	300 ~ 572	
W	FG	DDDDDD	0 ~ 128999	
W	PDT	D	0	
W	INT	DDDDDDDD	0 ~ 1281299	
W	RL	DDDDDDDD	0 ~ 1281399	
W	STR	DDDDDD	0 ~ 128998	
W	AX1Sensor	D	0	
W	AX2Sensor	D	0	
W	AX3Sensor	D	0	
W	AX1Error	D	0	
W	AX2Error	D	0	
W	AX3Error	D	0	
W	AX1Encode	D	0	

Bit/Word	Device type	Format	Range	Memo
W	AX2Encode	D	0	
W	AX3Encode	D	0	
W	AX1Positio23	D	0	
W	AX2Positio24	D	0	
W	AX3Positio25	D	0	
W	PGStatus	DDD	0 ~ 255	
W	PGStepNo	DDD	0 ~ 255	
W	PGError	DDD	0 ~ 255	
W	PGErrorNo	DDD	0 ~ 255	
W	SYST	D	0 ~ 6	
W	VR	HHH	0 ~ 3FF	
W	ER0	HHHH	0 ~ FFFF	
W	ER1	HHHH	0 ~ FFFF	
W	ER2	HHHH	0 ~ FFFF	
W	ER3	HHHH	0 ~ FFFF	
W	ER4	HHHH	0 ~ FFFF	
W	ER5	HHHH	0 ~ FFFF	
W	ER6	HHHH	0 ~ FFFF	
W	ER7	HHHH	0 ~ FFFF	
W	SV	D	0	
W	RO	D	0 ~ 3	
W	ACM	D	0	
W	RCM	D	0	
W	JIM	D	0	
W	PNM	D	0	
W	PD_Set	D	0	
W	PCLR	DDDDDD	0 ~ 999999	
W	AR0	D	0	
W	PR_253	DDD	0 ~ 128	
W	PR_254	DDD	0 ~ 128	
W	PR_255	DDD	0 ~ 128	
W	PR_256	DDD	0 ~ 128	
W	PR_257	DDD	0 ~ 128	
W	SR0	D	0	
W	OPR0	D	0	
W	ChSpd	D	0	
W	Stop_Canl	D	0 ~ 1	

Bit/Word	Device type	Format	Range	Memo
W	PD2_1Valu	D	0 ~ 7	
W	PD2_2Valu	D	0 ~ 7	
W	PD2_3Valu	D	0 ~ 7	
W	PD2_5Valu	D	0 ~ 7	
W	PD2_6Valu	D	0 ~ 7	
W	PD1_1Valu	D	0 ~ 7	
W	PD1_2Valu	D	0 ~ 7	
W	PD1_3Valu	D	0 ~ 7	
W	PD1_4Valu	D	0 ~ 7	
W	PD1_5Valu	D	0 ~ 7	
W	PD3_1Valu	D	0 ~ 7	
W	PD3_2Valu	D	0 ~ 7	
W	PD3_3Valu	D	0 ~ 7	
W	PD3_4Valu	D	0 ~ 7	
W	PD3_5Valu	D	0 ~ 7	

Note: ddd: Decimal, hhh: Hexadecimal, ooo: Octal.

Each model of CPU is different; it is recommended to refer to PLC Manual Device List.

Wiring Diagram:

Diagram 1

cMT Series	<i>cMT3151</i>
eMT Series	<i>eMT3070 / eMT3105 / eMT3120 / eMT3150</i>
MT-iE	<i>MT8073iE / MT8102iE</i>
MT-XE	<i>MT8092XE</i>
MT-iP	<i>MT6103iP</i>

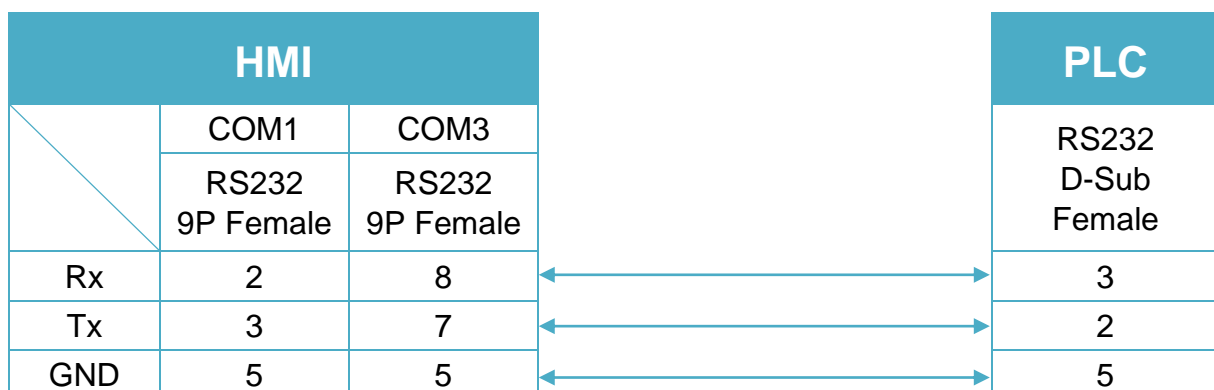


Diagram 2

cMT Series	cMT-SVR
mTV	mTV
MT-iE	MT8070iE / MT6070iE / MT8100iE / MT8121iE / MT8150iE / MT8071iE / MT6071iE / MT8072iE / MT6072iE / MT8073iE / MT8101iE / MT8102iE / MT8103iE
MT-XE	MT8121XE / MT8150XE / MT8090XE

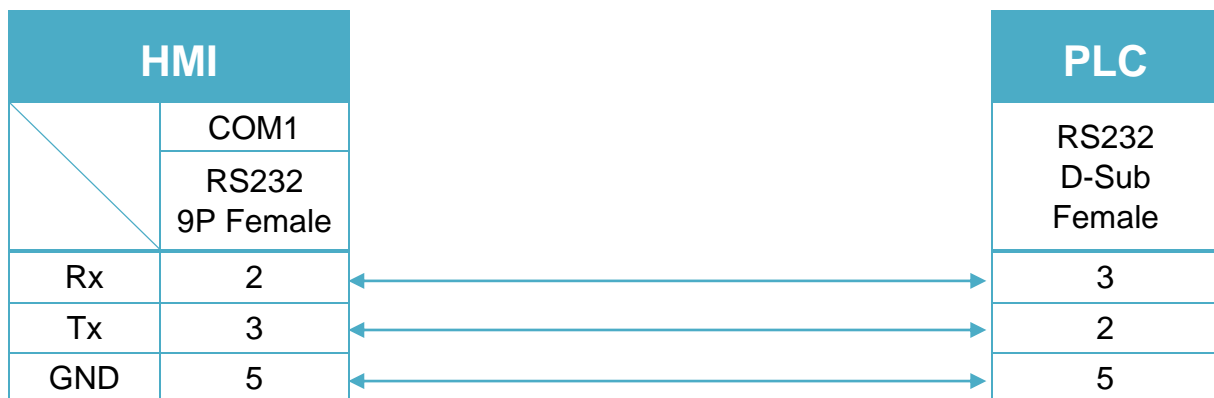
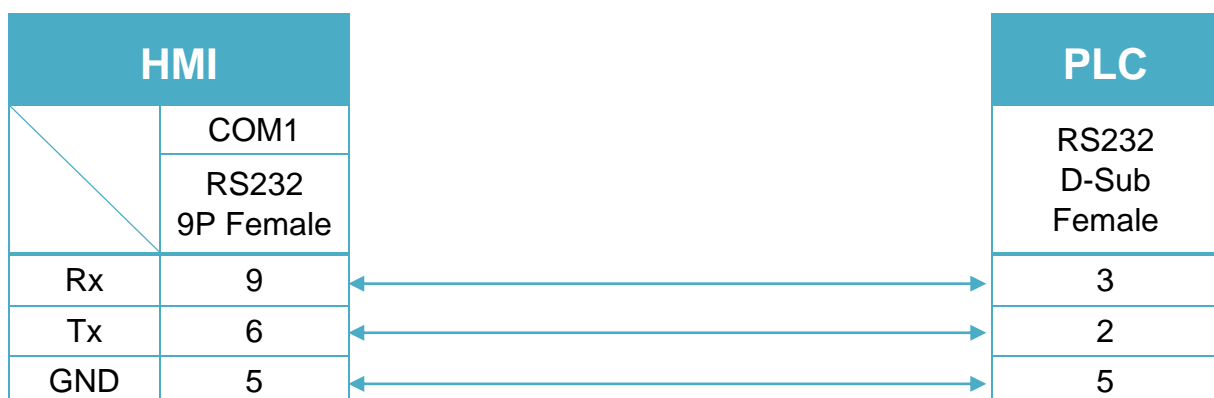


Diagram 3

MT-iE	MT8050iE
MT-iP	MT6051iP / MT6071iP / MT8071iP



IDEC Micro

Supported Series: IDEC Micro3, Micro3C, OpenNet Controller series.

Website: <http://www.idec.com>

HMI Setting:

Parameters	Recommended	Options	Notes
PLC type	IDEC Micro		
PLC I/F	RS232	RS232, RS485	
Baud rate	9600	9600, 19200	
Data bits	7	7, 8	
Parity	Even	Even, Odd, None	
Stop bits	1	1	
PLC sta. no.	255 (for 1:1 connect)	0-255	255 or same as the PLC setting

Online simulator	YES
Extend address mode	YES (Do not set the PLC Station No. to 255)

PLC Setting:

Communication mode	9600, E, 7, 1 (default), Use Computer Link Protocol
---------------------------	---

Device Address:

Bit/Word	Device type	Format	Range	Memo
B	X	DDDDo	0 ~ 20477	Input (I)
B	Y	DDDDo	0 ~ 20477	Output (Q)
B	M	DDDDo	0 ~ 20477	Internal Relay (M)
W	RT	DDDD	0 ~ 9999	Timer (T)
W	RC	DDDD	0 ~ 9999	Counter (C)
W	D	DDDD	0 ~ 9999	Data Register (D)

Wiring Diagram:

The following is the view from the soldering point of a connector.



Micro3C, MicroSmart, OpenNet Controller CPU Ladder Port (Diagram 1 ~ Diagram 3)

Diagram 1

cMT Series	<i>cMT3151</i>
eMT Series	<i>eMT3070 / eMT3105 / eMT3120 / eMT3150</i>
MT-iE	<i>MT8073iE / MT8102iE</i>
MT-XE	<i>MT8092XE</i>
MT-iP	<i>MT6103iP</i>

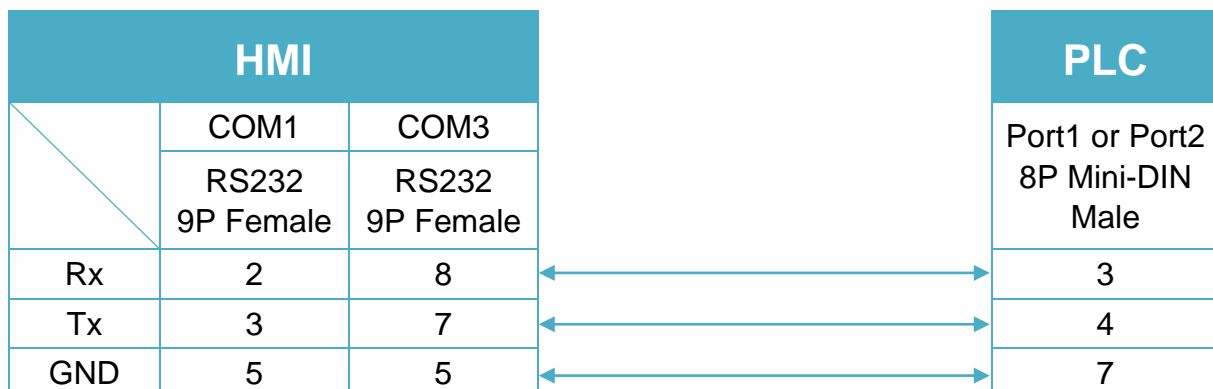


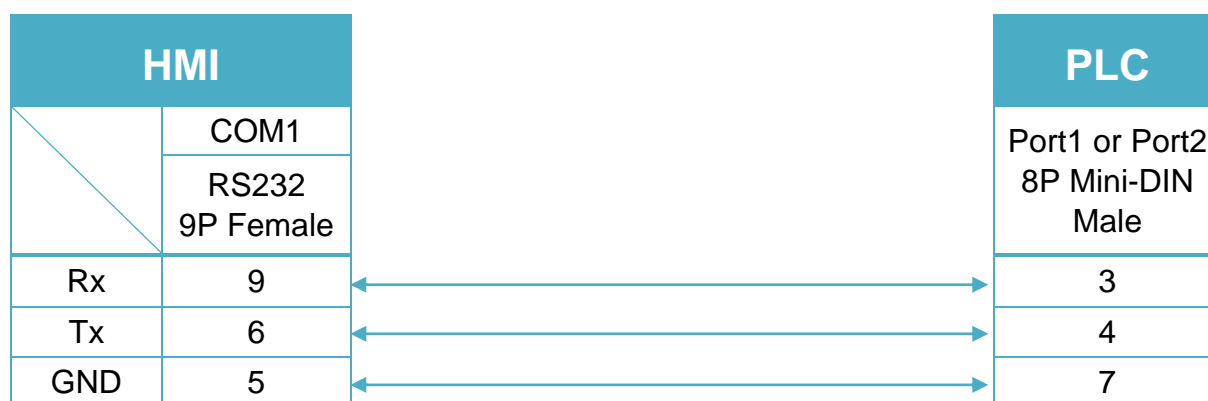
Diagram 2

cMT Series	cMT-SVR
mTV	mTV
MT-iE	MT8070iE / MT6070iE / MT8100iE / MT8121iE / MT8150iE / MT8071iE / MT6071iE / MT8072iE / MT6072iE / MT8073iE / MT8101iE / MT8102iE / MT8103iE
MT-XE	MT8121XE / MT8150XE / MT8090XE



Diagram 3

MT-iE	MT8050iE
MT-iP	MT6051iP / MT6071iP / MT8071iP



The following is the view from the soldering point of a connector.



Micro3 CPU Port, MicroSmart with FC4A-PC2 RS485 Communication Adapter (Diagram 4 ~ Diagram 9)

Diagram 4

cMT Series

cMT3151

eMT Series

eMT3070 / eMT3105 / eMT3120 / eMT3150

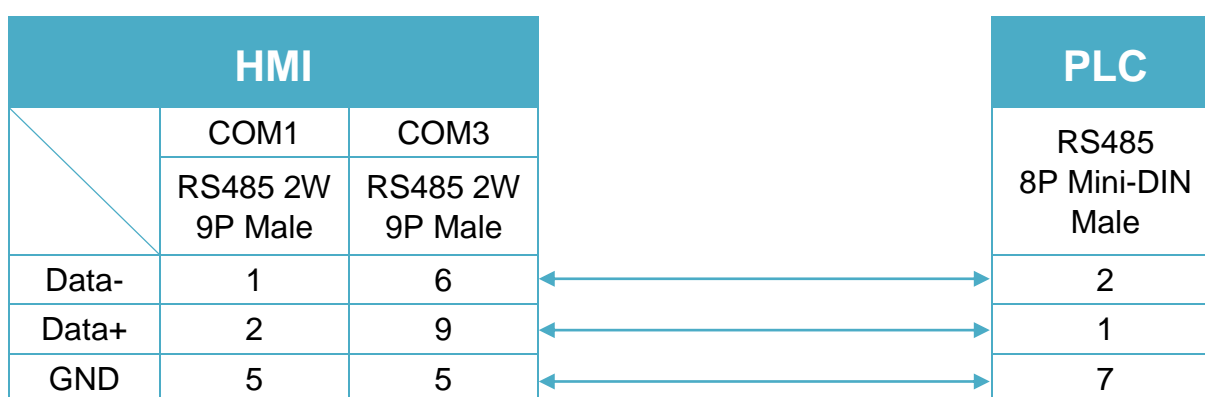


Diagram 5

cMT Series

cMT-SVR

mTV

mTV

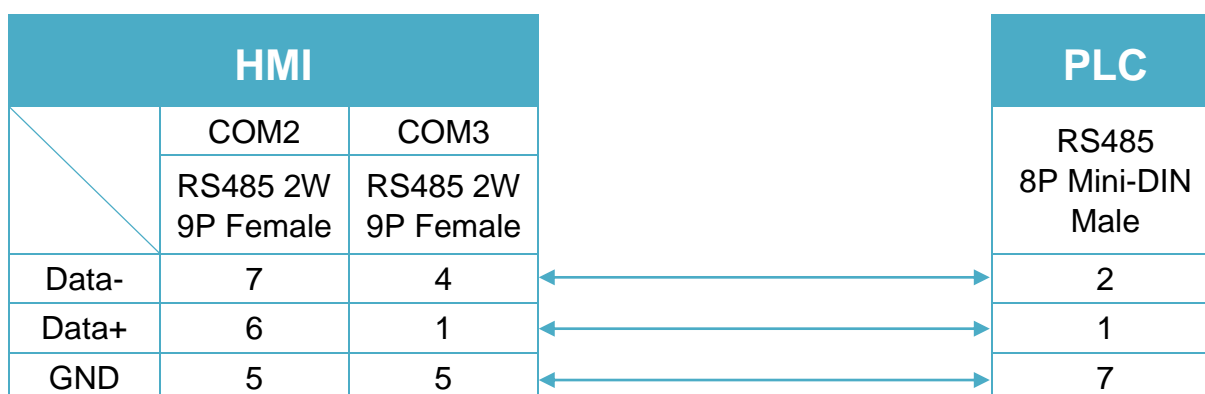


Diagram 6

MT-iE *MT8070iE / MT6070iE / MT8100iE / MT8121iE / MT8150iE*

MT-XE *MT8121XE / MT8150XE*

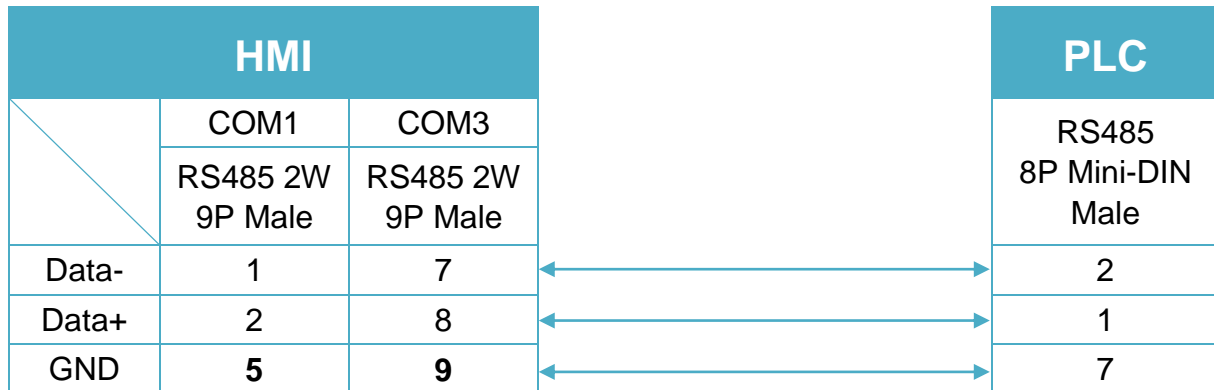


Diagram 7

MT-iE *MT8071iE / MT6071iE / MT8072iE / MT6072iE / MT8073iE / MT8101iE / MT8102iE / MT8103iE*

MT-XE *MT8090XE / MT8092XE*

MT-iP *MT6103iP*

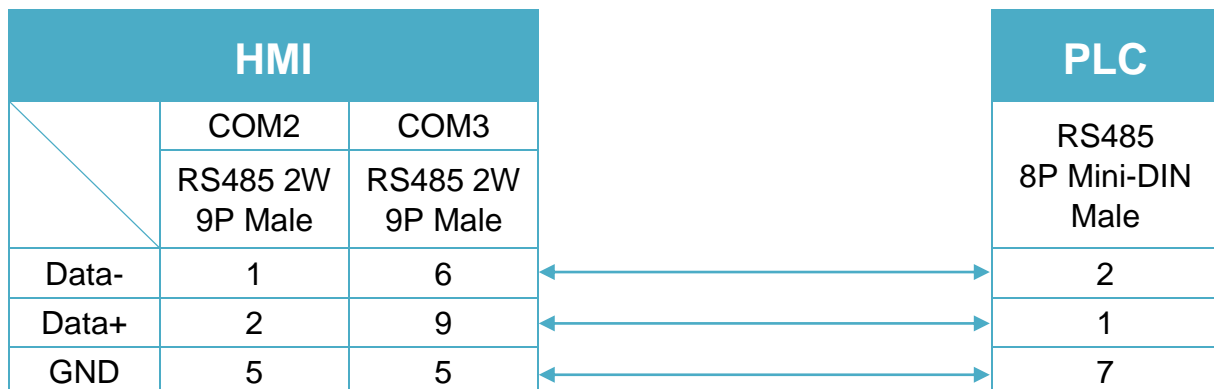
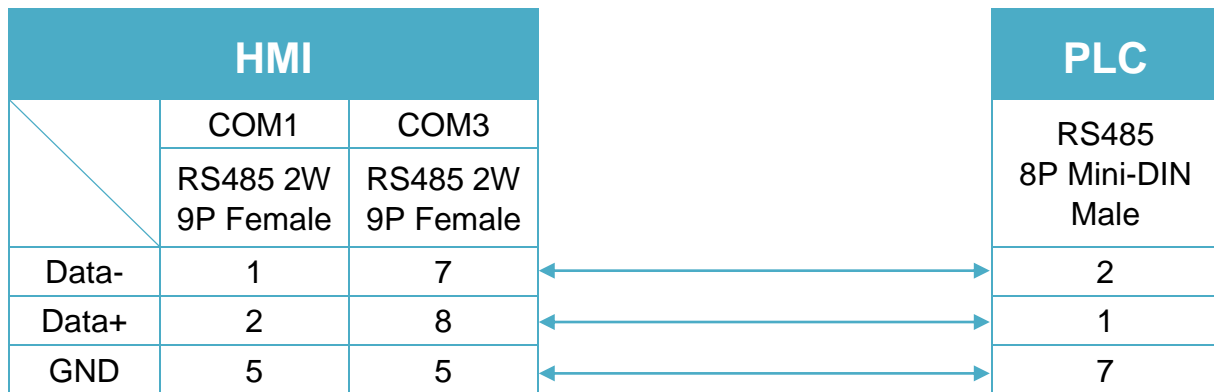
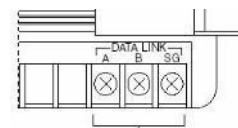


Diagram 8
MT-iE *MT8050iE*
MT-iP *MT6051iP*

Diagram 9
MT-iP *MT6071iP / MT8071iP*


The following is the view from the soldering point of a connector.



Micro3C, OpenNet Controller Data Link Terminals, MicroSmart with FC4A-PC3 RS485 Communication Adapter (Diagram 10 ~ Diagram 15)

Diagram 10

cMT Series *cMT3151*

eMT Series *eMT3070/ eMT3105 / eMT3120 / eMT3150*

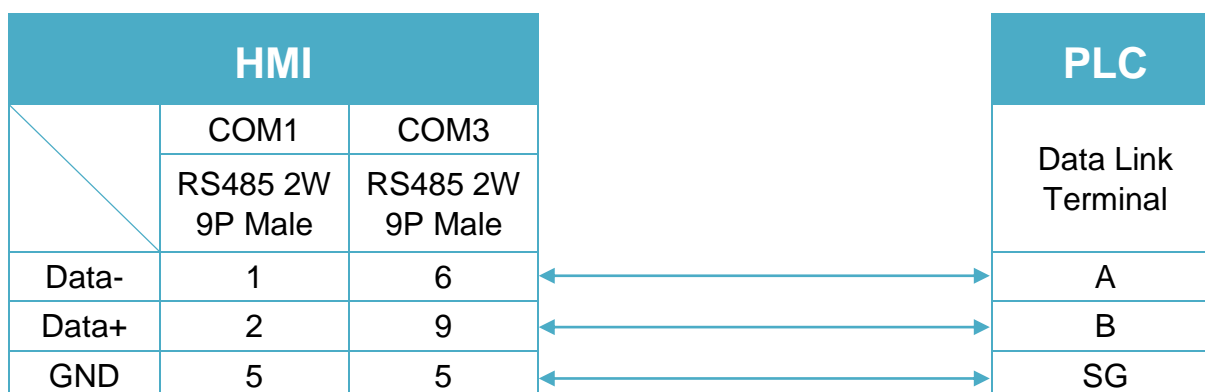


Diagram 11

cMT Series *cMT-SVR*

mTV *mTV*

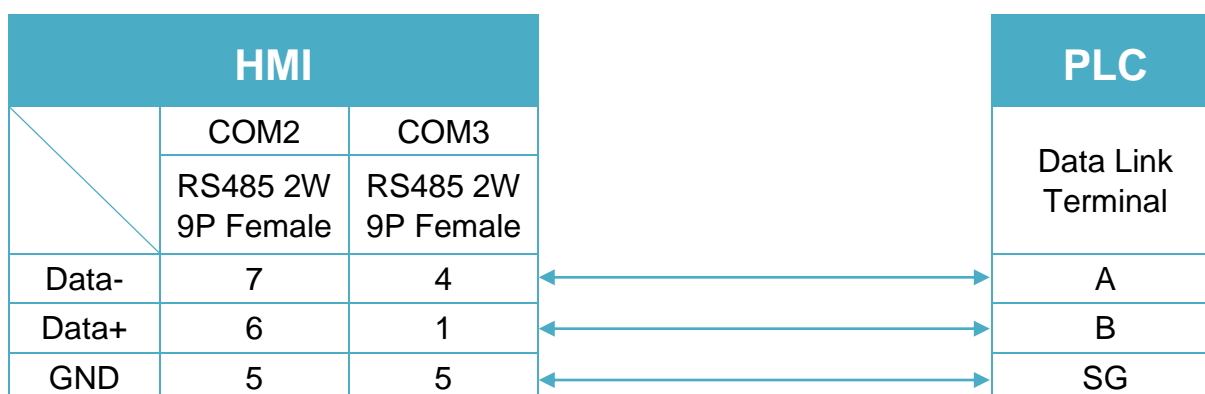


Diagram 12

MT-iE *MT8070iE / MT6070iE / MT8100iE / MT8121iE / MT8150iE*

MT-XE *MT8121XE / MT8150XE*

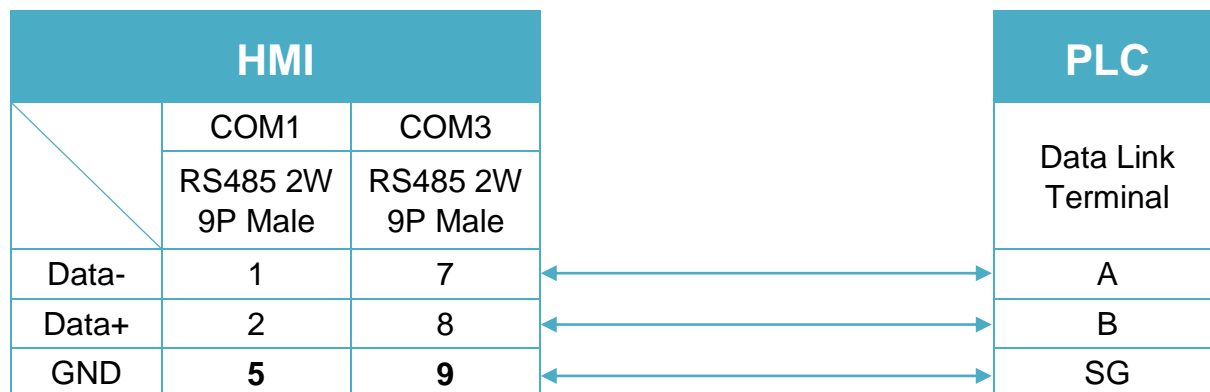


Diagram 13

MT-iE *MT8071iE / MT6071iE / MT8072iE / MT6072iE / MT8073iE /
MT8101iE / MT8102iE / MT8103iE*

MT-XE *MT8090XE / MT8092XE*

MT-iP *MT6103iP*

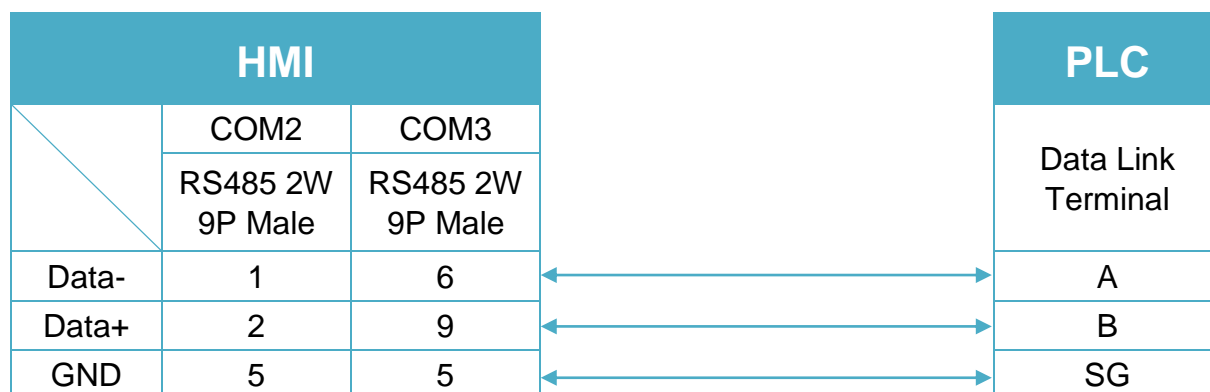


Diagram 14

MT-iE *MT8050iE*

MT-iP *MT6051iP*

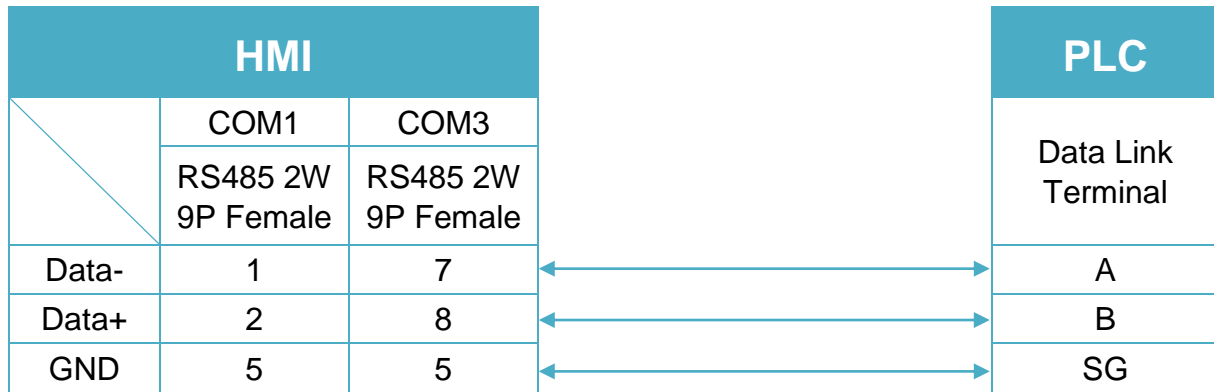


Diagram 15

MT-iP *MT6071iP / MT8071iP*



IDEC MicroSmart

Supported Series: IDEC MicroSmart , SmartAxis series.

Website: <http://www.idec.com>

HMI Setting:

Parameters	Recommended	Options	Notes
PLC type	IDEC MicroSmart		
PLC I/F	RS232	RS232, RS485, Ethernet	
Baud rate	9600	9600, 19200	
Data bits	7	7, 8	
Parity	Even	Even, Odd, None	
Stop bits	1	1	
PLC sta. no.	255 (for 1:1 connect)	0-255	255 or same as the PLC setting

Online simulator	YES	
Extend address mode	YES	Do not set the PLC Station No. to 255

PLC Setting:

Communication mode	9600, E, 7, 1 (default), Use Computer Link Protocol
---------------------------	---

Device Address:

Bit/Word	Device type	Format	Range	Memo
B	I	DDDDo	0 ~ 20477	Input (I)
B	Q	DDDDo	0 ~ 20477	Output (Q)
B	M	DDDDo	0 ~ 20477	Internal Relay (M)
B	R	DDDD	0 ~ 2047	Shift Register (R)
B	T	DDDD	0 ~ 2047	Timer (T)
B	C	DDDD	0 ~ 2047	Counter (C)
W	TP	DDDD	0 ~ 9999	Timer Preset
W	CP	DDDD	0 ~ 9999	Counter Preset
W	D	DDDD	0 ~ 9999	Data Register (D)
W	TC	DDDD	0 ~ 9999	Timer Current
W	CC	DDDD	0 ~ 9999	Counter Current

Wiring Diagram:

The following is the view from the soldering point of a connector.



MicroSmart , SmartAxis CPU Ladder Port (Diagram 1 ~ Diagram 3)

Diagram 1

cMT Series	<i>cMT3151</i>
eMT Series	<i>eMT3070 / eMT3105 / eMT3120 / eMT3150</i>
MT-iE	<i>MT8073iE / MT8102iE</i>
MT-XE	<i>MT8092XE</i>
MT-iP	<i>MT6103iP</i>

HMI			PLC
	COM1	COM3	Port1 or Port2 8P Mini-DIN Male
	RS232 9P Female	RS232 9P Female	
Rx	2	8	3
Tx	3	7	4
GND	5	5	7

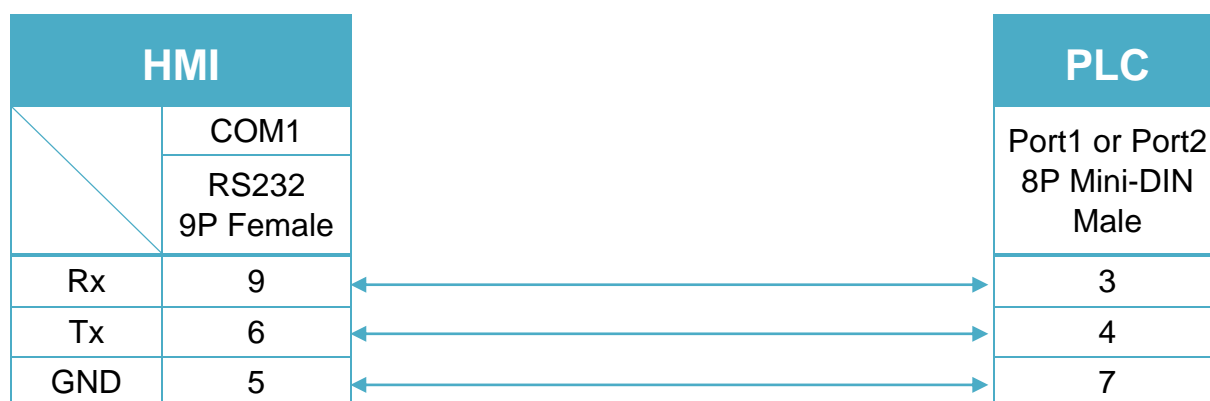
Diagram 2

cMT Series	cMT-SVR
mTV	mTV
MT-iE	MT8070iE / MT6070iE / MT8100iE / MT8121iE / MT8150iE / MT8071iE / MT6071iE / MT8072iE / MT6072iE / MT8073iE / MT8101iE / MT8102iE / MT8103iE
MT-XE	MT8121XE / MT8150XE / MT8090XE



Diagram 3

MT-iE	MT8050iE
MT-iP	MT6051iP / MT6071iP / MT8071iP



The following is the view from the soldering point of a connector.



MicroSmart , SmartAxis with FC4A-PC2 RS485 Communication Adapter (Diagram 4 ~ Diagram 9)

Diagram 4

cMT Series

cMT3151

eMT Series

eMT3070 / eMT3105 / eMT3120 / eMT3150

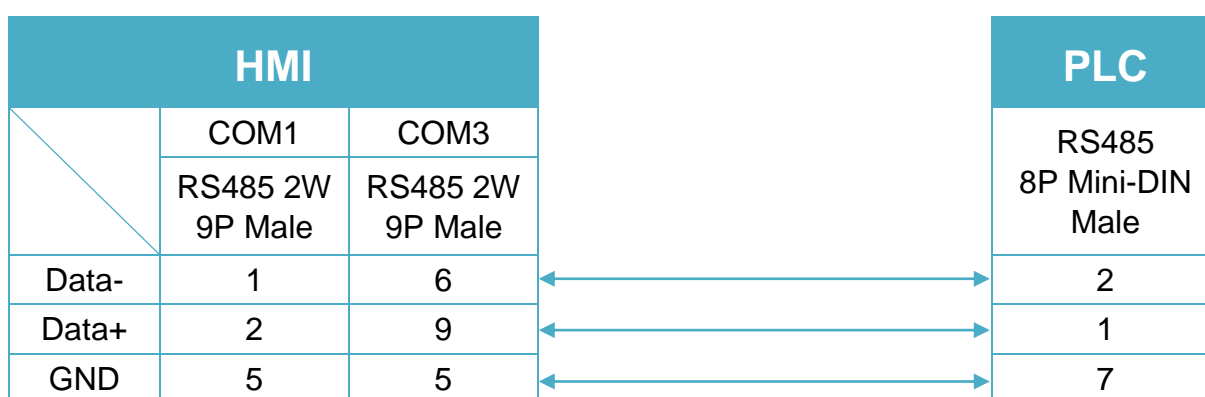


Diagram 5

cMT Series

cMT-SVR

mTV

mTV

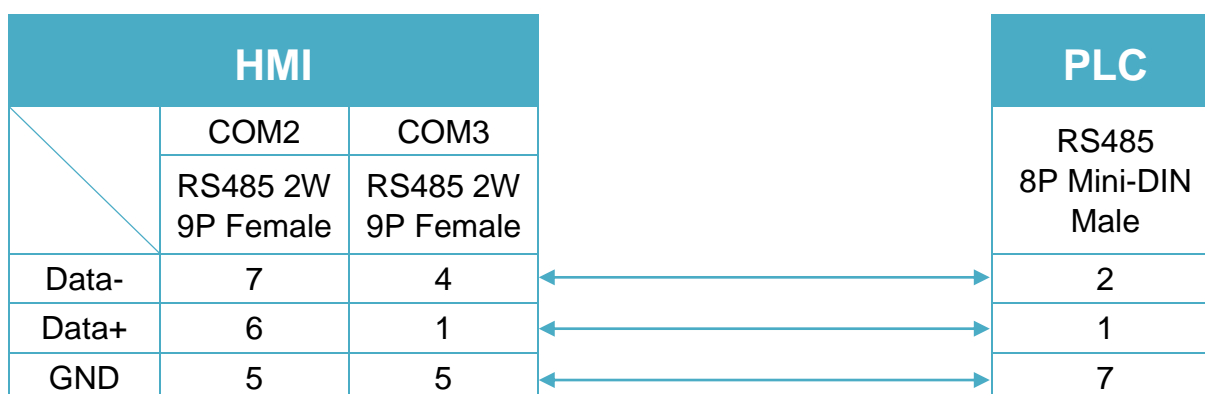


Diagram 6

MT-iE *MT8070iE / MT6070iE / MT8100iE / MT8121iE / MT8150iE*

MT-XE *MT8121XE / MT8150XE*

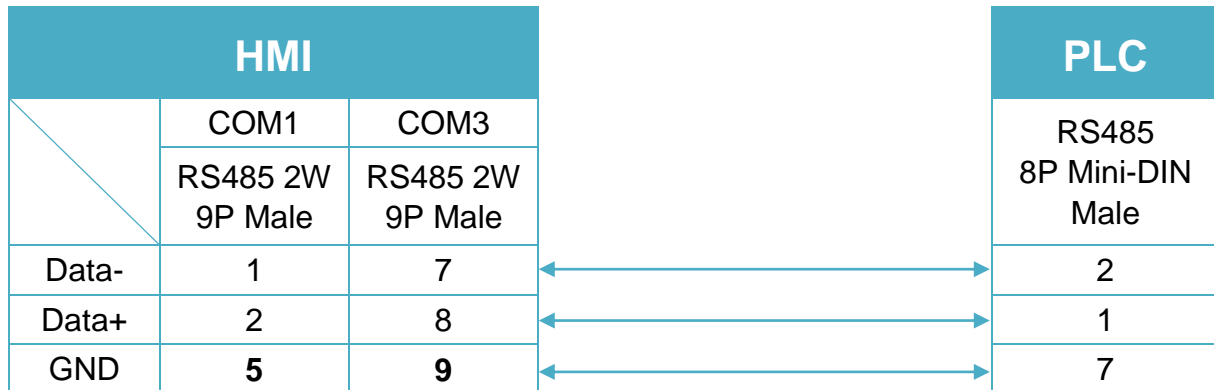


Diagram 7

MT-iE *MT8071iE / MT6071iE / MT8072iE / MT6072iE / MT8073iE /
MT8101iE / MT8102iE / MT8103iE*

MT-XE *MT8090XE / MT8092XE*

MT-iP *MT6103iP*

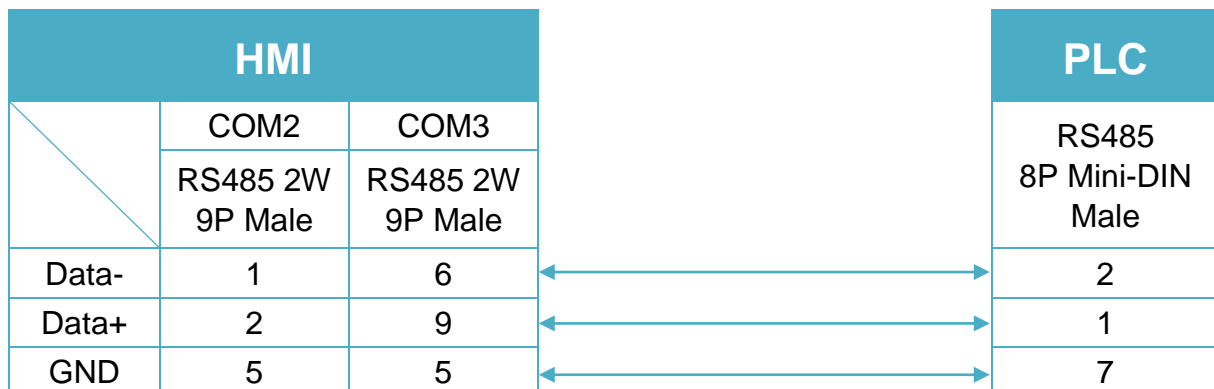
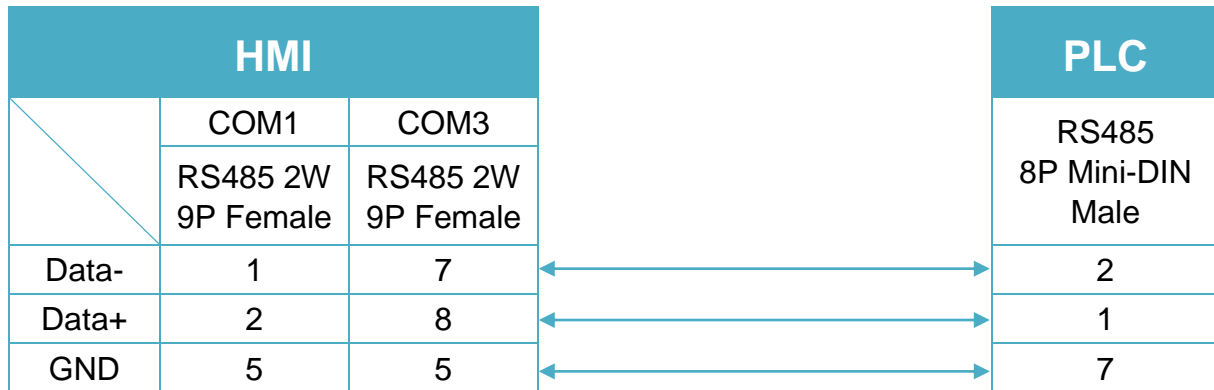
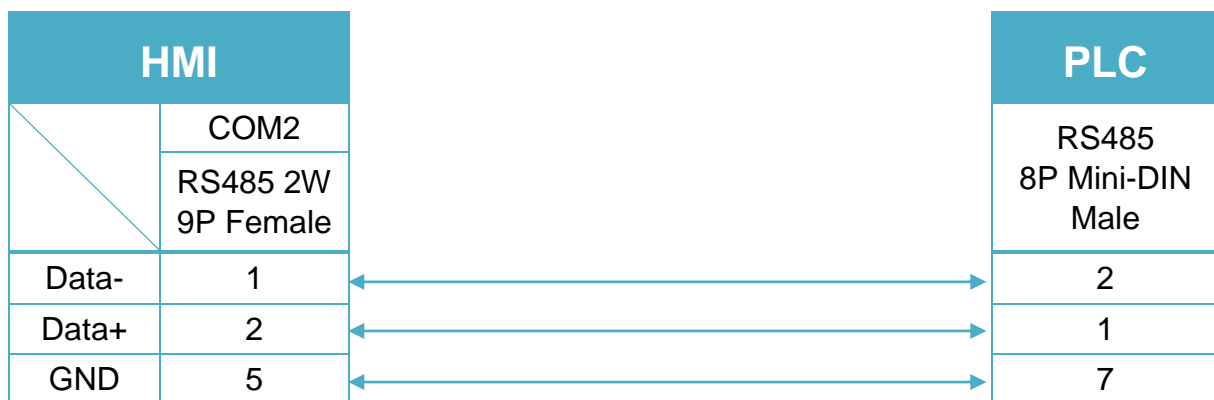
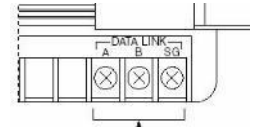


Diagram 8
MT-iE *MT8050iE*
MT-iP *MT6051iP*

Diagram 9
MT-iP *MT6071iP / MT8071iP*


The following is the view from the soldering point of a connector.



MicroSmart , SmartAxis with FC4A-PC3 RS485 Communication Adapter (Diagram 10 ~ Diagram 15)

Diagram 10

cMT Series

cMT3151

eMT Series

eMT3070/ eMT3105 / eMT3120 / eMT3150

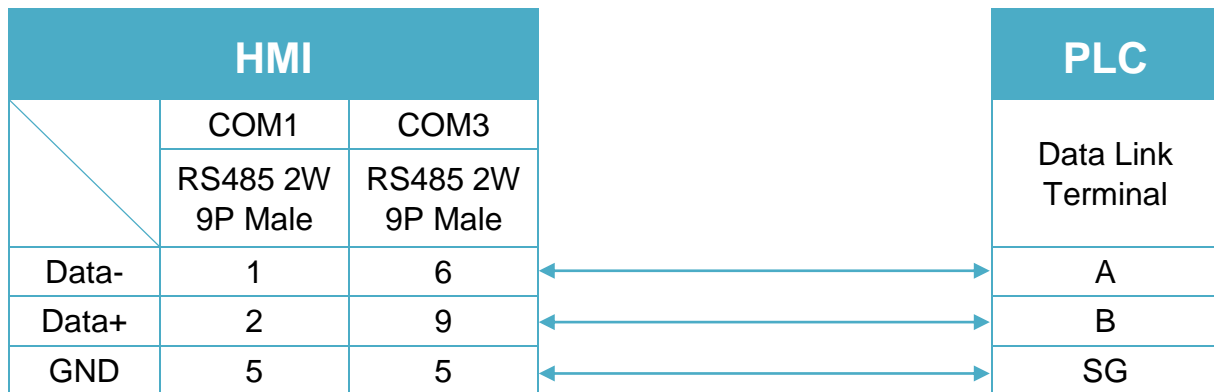


Diagram 11

cMT Series

cMT-SVR

mTV

mTV

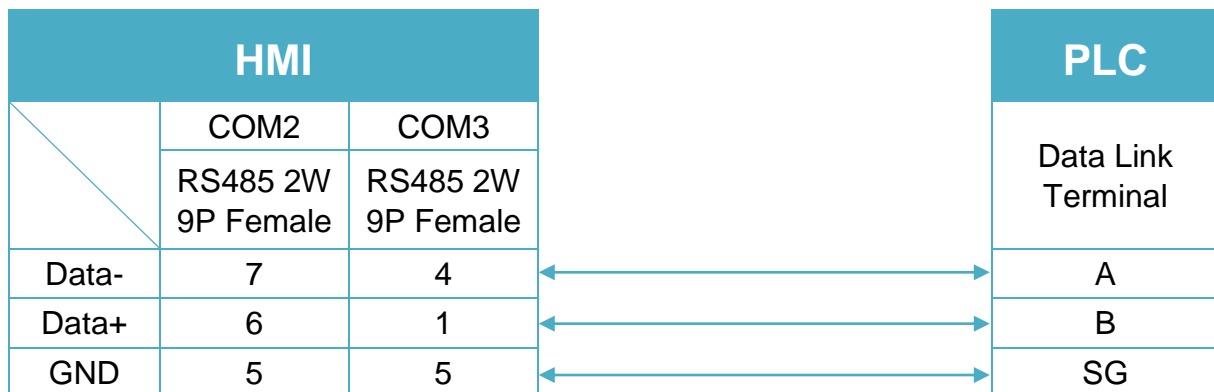


Diagram 12

MT-iE *MT8070iE / MT6070iE / MT8100iE / MT8121iE / MT8150iE*

MT-XE *MT8121XE / MT8150XE*

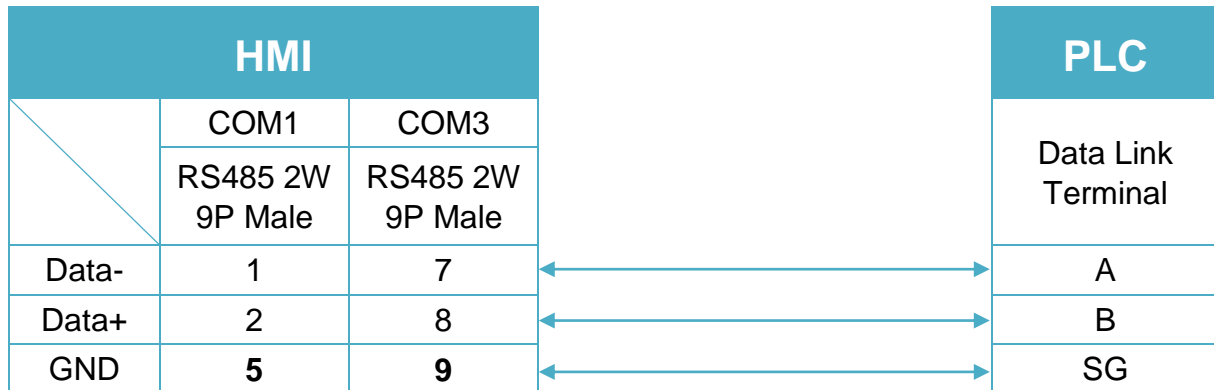


Diagram 13

MT-iE *MT8071iE / MT6071iE / MT8072iE / MT6072iE / MT8073iE /
MT8101iE / MT8102iE / MT8103iE*

MT-XE *MT8090XE / MT8092XE*

MT-iP *MT6103iP*

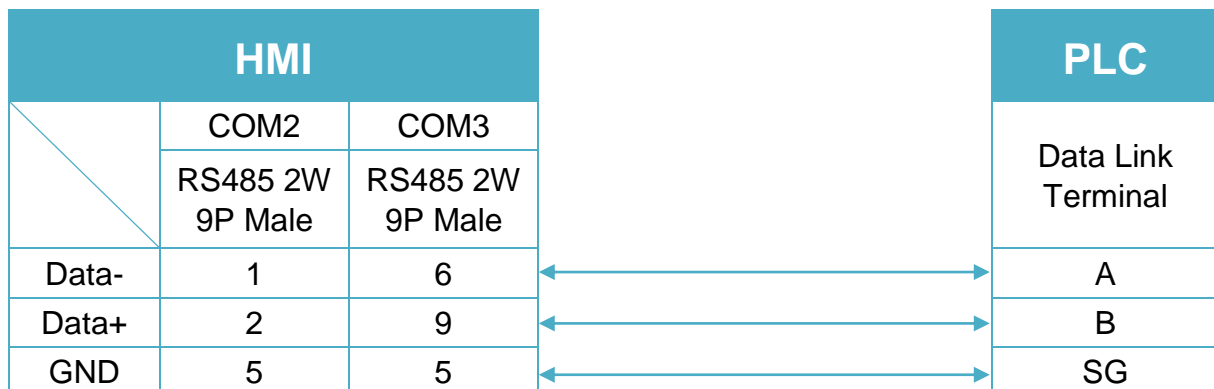


Diagram 14

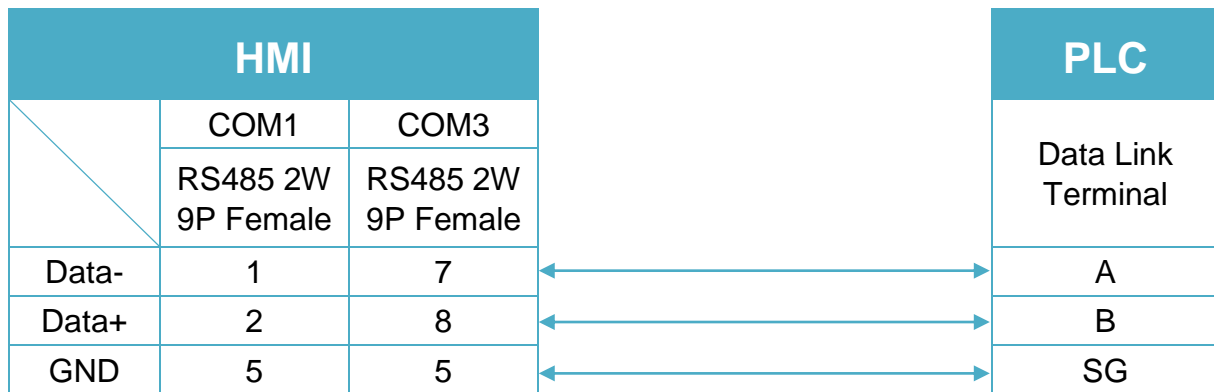
MT-iE *MT8050iE*
MT-iP *MT6051iP*


Diagram 15

MT-iP *MT6071iP / MT8071iP*


Diagram 16

Ethernet cable:


IDEC MicroSmart FC6A Series

Supported Series: IDEC MicroSmart FC6A Series

Website: <http://www.idec.com>

HMI Setting:

Parameters	Recommended	Options	Notes
PLC type	IDEC MicroSmart FC6A Series		
PLC I/F	RS232	RS232, RS485, Ethernet	
Baud rate	9600	9600, 19200	
Data bits	7	7, 8	
Parity	Even	Even, Odd, None	
Stop bits	1	1	
PLC sta. no.	255 (for 1:1 connect)	0-255	255 or same as the PLC setting

Online simulator	YES	
Extend address mode	YES	Do not set the PLC Station No. to 255

PLC Setting:

Communication mode	9600, E, 7, 1 (default), Use Computer Link Protocol
---------------------------	---

Device Address:

Bit/Word	Device type	Format	Range	Memo
B	I	DDo	0 ~ 637	Input (I)
B	Q	DDo	0 ~ 637	Output (Q)
B	M	DDDDo	0 ~ 17497	Internal Relay (M)
B	R	DDD	0 ~ 255	Shift Register (R)
B	T	DDDD	0 ~ 1023	Timer (T)
B	C	DDD	0 ~ 511	Counter (C)
B	D_Bit	DDDDDDdd	0 ~ 5599915	Data Register Bit
W	IW	DDo	0 ~ 620	Input (16bit)
W	QW	DDo	0 ~ 620	Output (16bit)
W	MW	DDDDo	0 ~ 17480	Internal Relay (16bit)
W	RW	DDD	0 ~ 240	Shift Register (16bit)

Bit/Word	Device type	Format	Range	Memo
W	TP	DDDD	0 ~ 1023	Timer Preset
W	CP	DDD	0 ~ 511	Counter Preset
W	TC	DDDD	0 ~ 1023	Timer Current
W	CC	DDD	0 ~ 511	Counter Currnet
W	D	DDDDD	0 ~ 55999	Data Register (16bit)
DW	I_32Bit	DDo	0 ~ 600	Input (32bit)
DW	Q_32Bit	DDo	0 ~ 600	Output (32bit)
DW	M_32Bit	DDDDo	0 ~ 17460	Internal Relay (32bit)
DW	R_32Bit	DDD	0 ~ 224	Shift Register (32bit)
DW	D_32Bit	DDDDD	0 ~ 55998	Data Register (32bit)

Wiring Diagram:

The following is the view from the soldering point of a connector.



MicroSmart , SmartAxis CPU Ladder Port (Diagram 1 ~ Diagram 3)

Diagram 1

cMT Series	cMT3151
eMT Series	eMT3070/ eMT3105 / eMT3120 / eMT3150
MT-iE	MT8073iE / MT8102iE
MT-XE	MT8092XE
MT-iP	MT6103iP

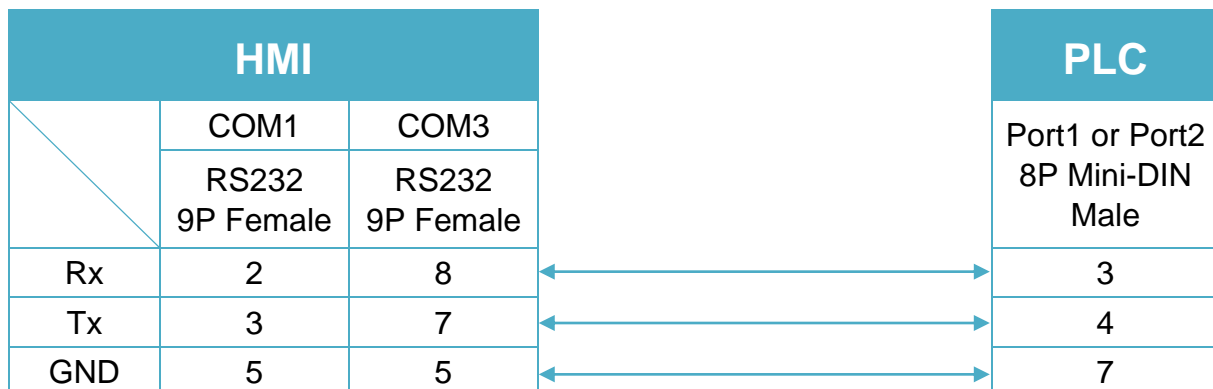


Diagram 2

cMT Series	cMT-SVR
mTV	mTV
MT-iE	MT8070iE / MT6070iE / MT8100iE / MT8121iE / MT8150iE / MT8071iE / MT6071iE / MT8072iE / MT6072iE / MT8073iE / MT8101iE / MT8102iE / MT8103iE
MT-XE	MT8121XE / MT8150XE / MT8090XE

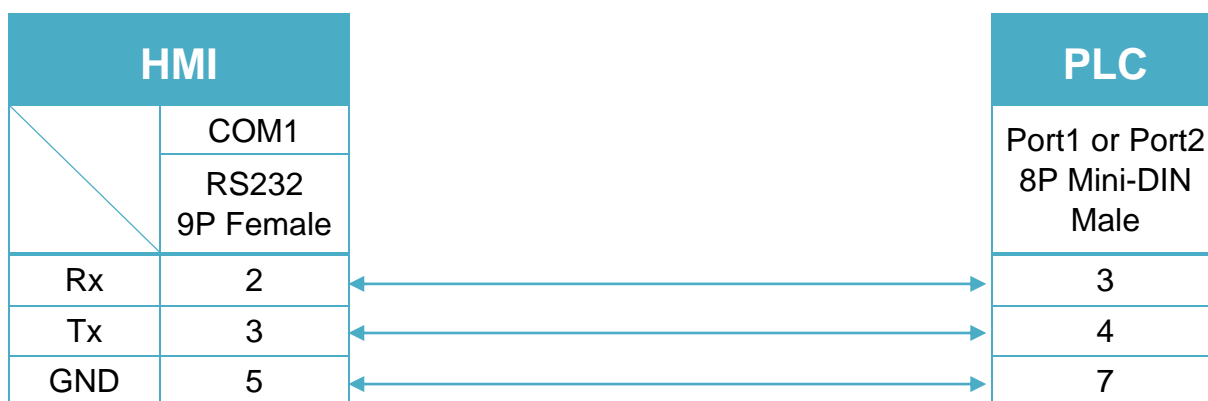
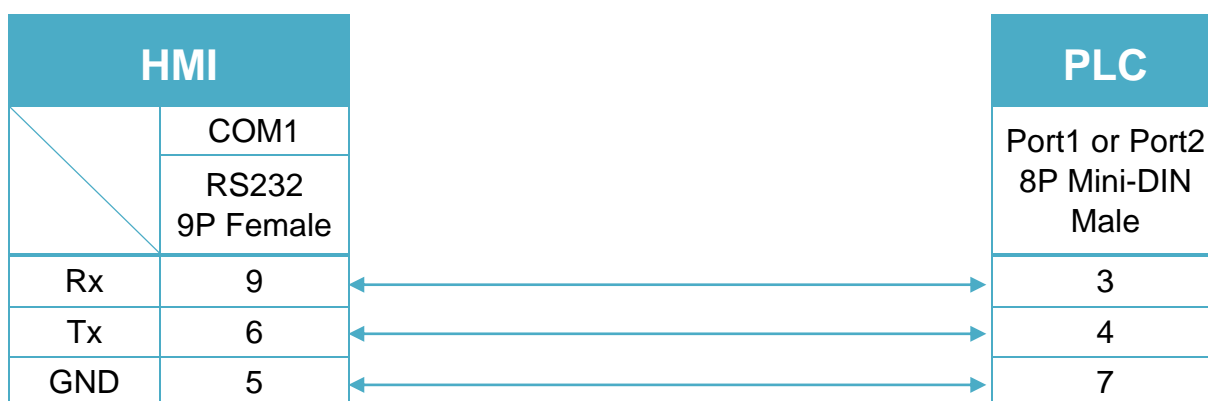


Diagram 3

MT-iE	MT8050iE
MT-iP	MT6051iP / MT6071iP / MT8071iP



The following is the view from the soldering point of a connector.



MicroSmart , SmartAxis with FC4A-PC2 RS485 Communication Adapter (Diagram 4 ~ Diagram 9)

Diagram 4

cMT Series

cMT3151

eMT Series

eMT3070 / eMT3105 / eMT3120 / eMT3150

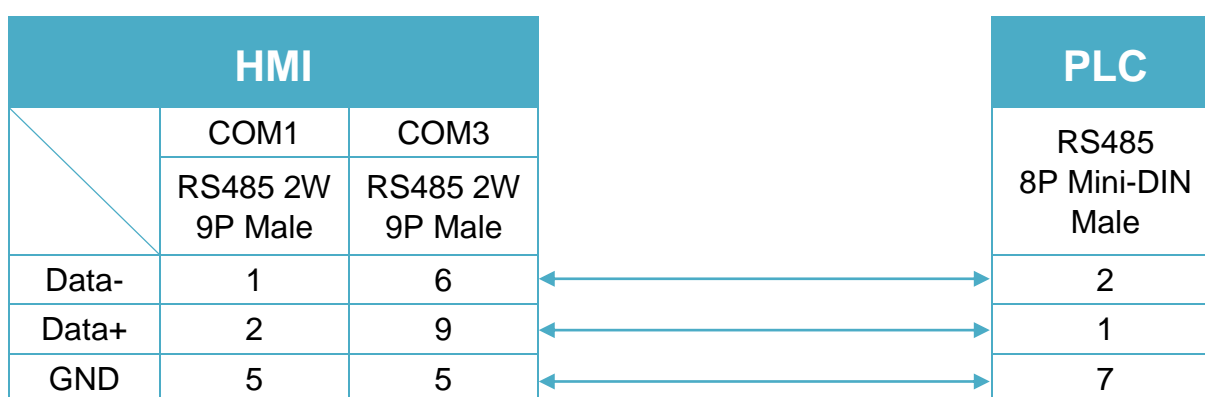


Diagram 5

cMT Series

cMT-SVR

mTV

mTV

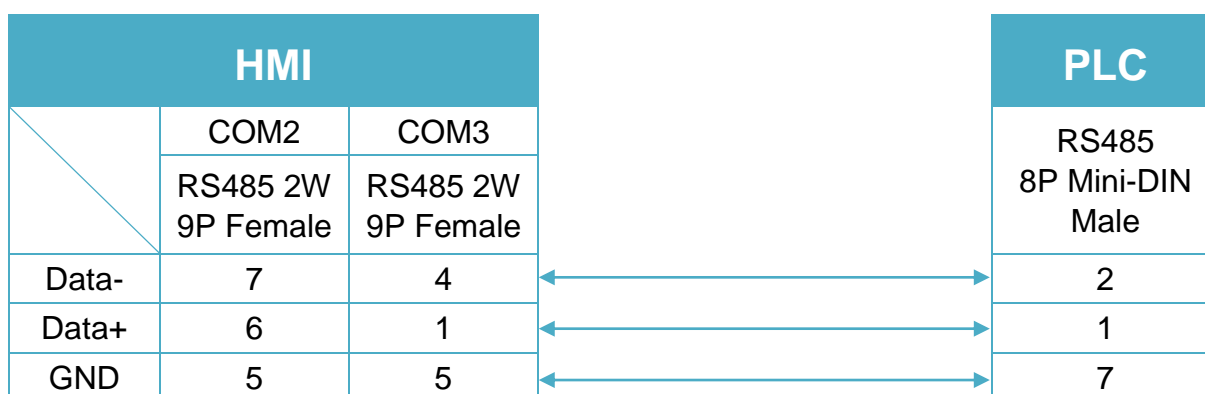


Diagram 6

MT-iE *MT8070iE / MT6070iE / MT8100iE / MT8121iE / MT8150iE*

MT-XE *MT8121XE / MT8150XE*

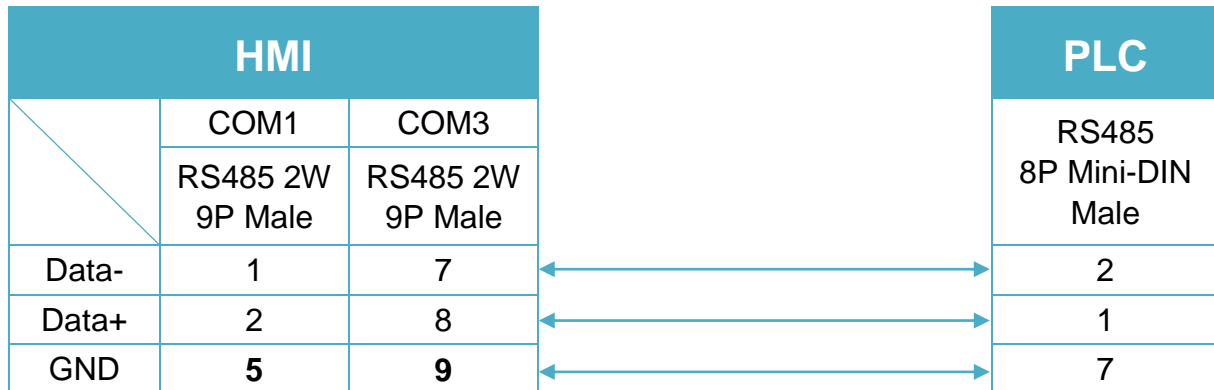


Diagram 7

MT-iE *MT8071iE / MT6071iE / MT8072iE / MT6072iE / MT8073iE /
MT8101iE / MT8102iE / MT8103iE*

MT-XE *MT8090XE / MT8092XE*

MT-iP *MT6103iP*

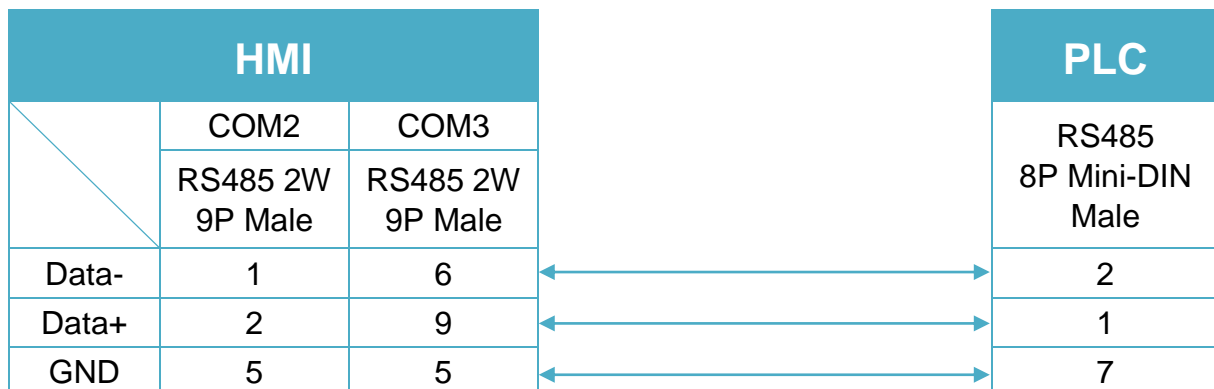
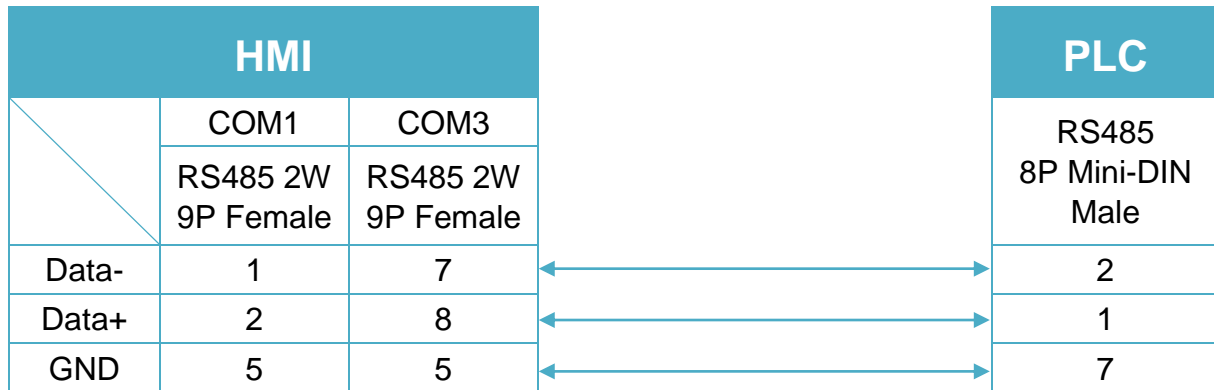
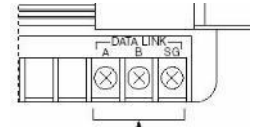


Diagram 8
MT-iE *MT8050iE*
MT-iP *MT6051iP*

Diagram 9
MT-iP *MT6071iP / MT8071iP*


The following is the view from the soldering point of a connector.



MicroSmart , SmartAxis with FC4A-PC3 RS485 Communication Adapter (Diagram 10 ~ Diagram 15)

Diagram 10

cMT Series *cMT3151*

eMT Series *eMT3070/ eMT3105 / eMT3120 / eMT3150*

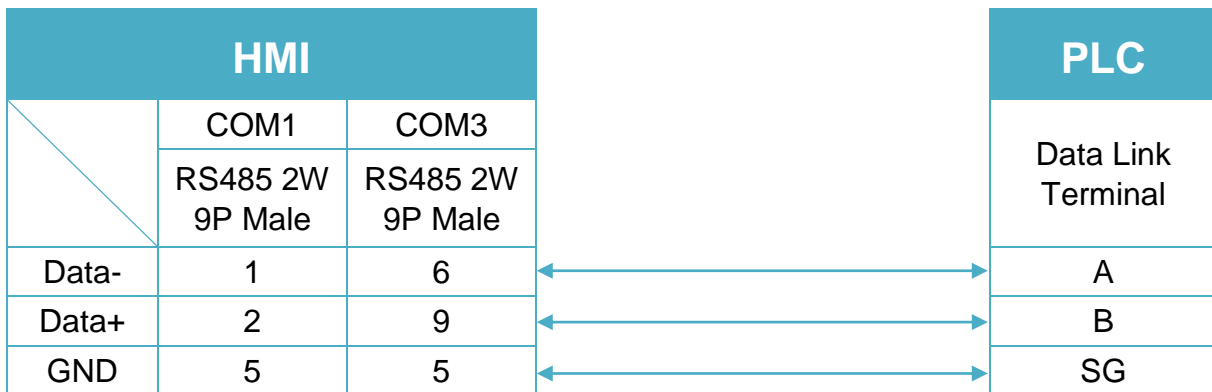


Diagram 11

cMT Series *cMT-SVR*

mTV *mTV*

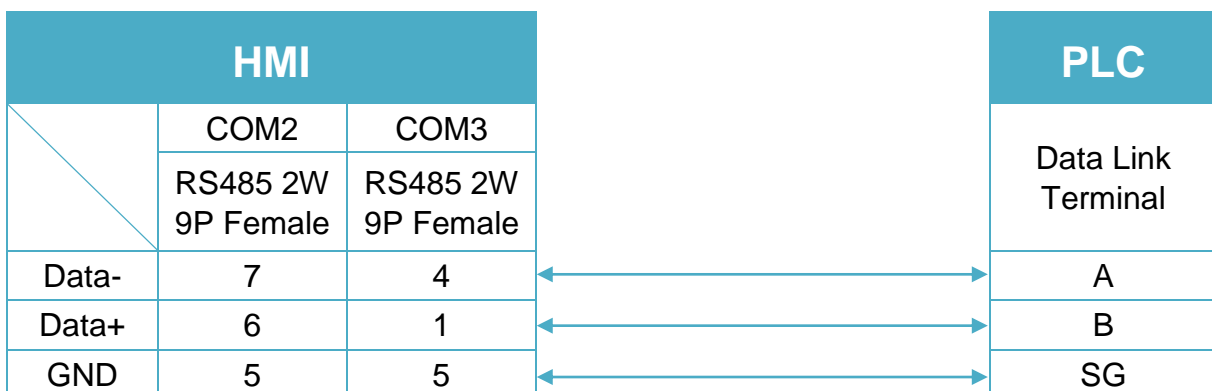


Diagram 12

MT-iE *MT8070iE / MT6070iE / MT8100iE / MT8121iE / MT8150iE*

MT-XE *MT8121XE / MT8150XE*

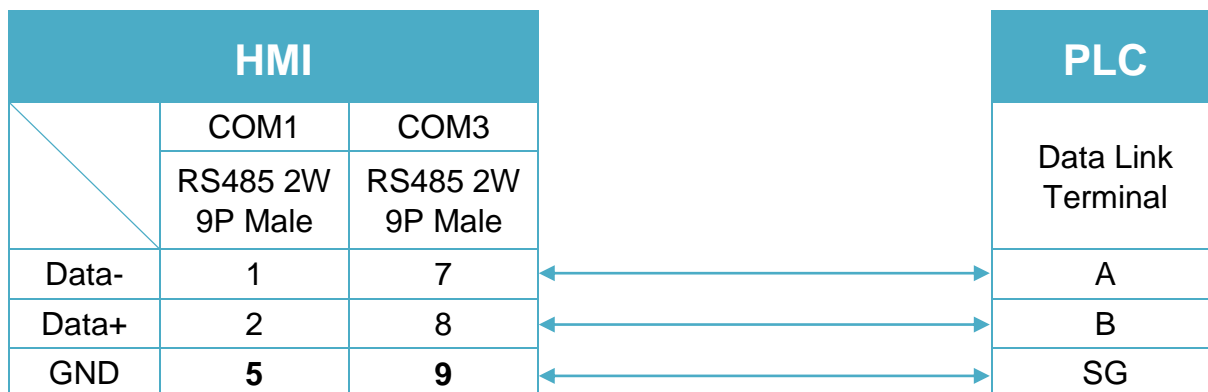


Diagram 13

MT-iE *MT8071iE / MT6071iE / MT8072iE / MT6072iE / MT8073iE /
MT8101iE / MT8102iE / MT8103iE*

MT-XE *MT8090XE / MT8092XE*

MT-iP *MT6103iP*

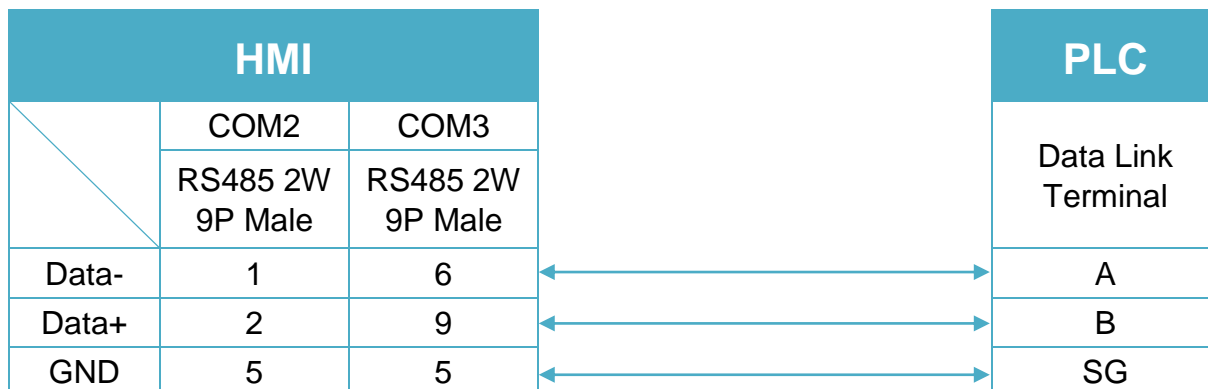


Diagram 14

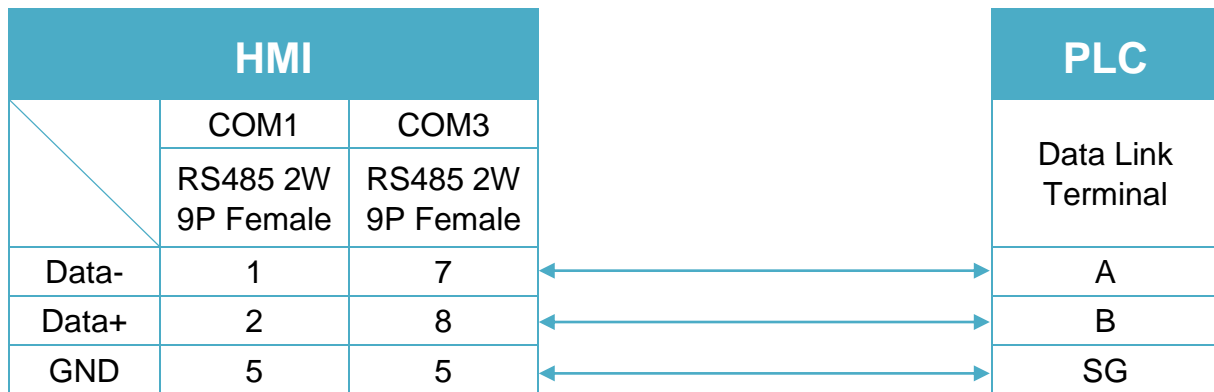
MT-iE *MT8050iE*
MT-iP *MT6051iP*


Diagram 15

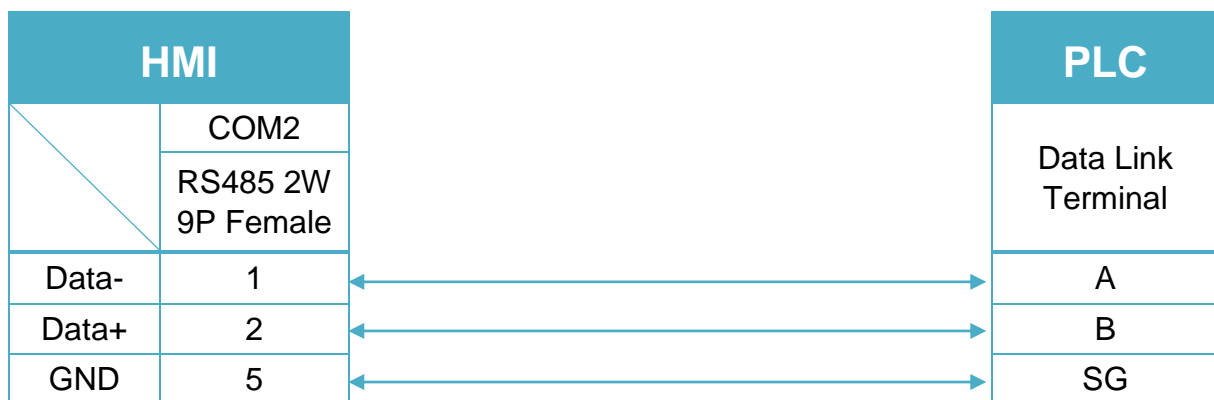
MT-iP *MT6071iP / MT8071iP*


Diagram 16

Ethernet cable:


IEC 60870-5-104 IEC 104 Client

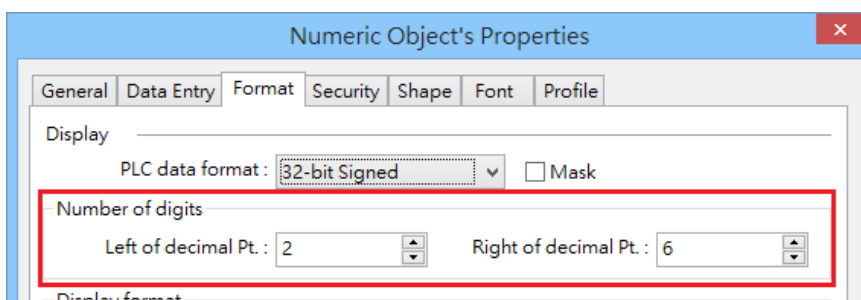
HMI Setting:

Parameters	Recommended	Options	Notes
PLC type	IEC 60870-5-104 IEC 104 Client		
PLC I/F	Ethernet		
Port no.	2404		

Device Address:

Bit/Word	Device type	Format	Range	Memo
B	Single Point	DDDDDDDD	0 ~ 16777215	
B	Single Command	DDDDDDDD	0 ~ 16777215	
B	Interrogation Command	D	0	
W	Double Point	DDDDDDDD	0 ~ 16777215	
W	Measured Normalized	DDDDDDDD	0 ~ 16777215	*Note1
W	Measured Scaled	DDDDDDDD	0 ~ 16777215	
W	Measured Float	DDDDDDDD	0 ~ 16777215	
W	Integrated Totals	DDDDDDDD	0 ~ 16777215	
W	Step Position	DDDDDDDD	0 ~ 16777215	
W	Bitstring 32bit	DDDDDDDD	0 ~ 16777215	
W	Double Command	DDDDDDDD	0 ~ 16777215	
W	SetPoint Normalized Command	DDDDDDDD	0 ~ 16777215	*Note1
W	SetPoint Scaled Command	DDDDDDDD	0 ~ 16777215	
W	SetPoint Float Command	DDDDDDDD	0 ~ 16777215	
W	Regulating Step Command	DDDDDDDD	0 ~ 16777215	
W	Bitstring Step Command	DDDDDDDD	0 ~ 16777215	

*Note1: See below for number of digits setting.



Wiring Diagram:

Diagram 1

Ethernet cable:



IEC 60870-5-104 IEC 104 Server

HMI Setting:

Parameters	Recommended	Options	Notes
PLC type	IEC 60870-5-104 IEC 104 Server		
PLC I/F	Ethernet		
Port no.	2404		
Sector	257	0 ~ 65535	*note1
Timing (T3)	10		*note2
Timing (K)	12	1 ~ 32767	*note3

*Note1: only one client can be connected at a time.

*Note2: When there's no data transferred from server or client, a keep -alive package will be sent in the specified interval of time.

*Note3: Communication will stop when the number of not received APDU reaches 12.

Device Address:

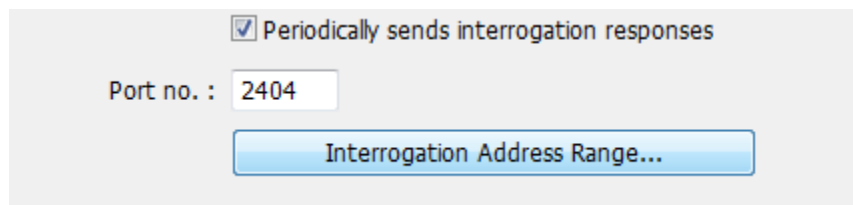
Bit/Word	Device type	Format	Range	Memo
B	Single Point	DDDDD	0 ~ 65535	
B	Single Command	DDDDD	0 ~ 65535	
B	Double Point	DDDDD	0 ~ 65535	
B	Measured Scaled	DDDDD	0 ~ 65535	
B	Measured Float	DDDDD	0 ~ 65535	
B	Integrated Totals	DDDDD	0 ~ 65535	
B	Step Position	DDDDD	0 ~ 65535	
B	Bitstring 32bit	DDDDD	0 ~ 65535	
W	Double Command	DDDDD	0 ~ 65535	
W	SetPoint Scaled Command	DDDDD	0 ~ 65535	
W	SetPoint Float Command	DDDDD	0 ~ 65535	
W	Regulating Step Command	DDDDD	0 ~ 65535	
W	Bitstring 32bit Command	DDDDD	0 ~ 65535	

Application:

Upper computer IEC 104 Client-----HMI (IEC 104 Server) -----Modbus RTU

Periodically sends interrogation responses:

Select [Periodically sends interrogation responses] checkbox and then click [Interrogation Address Range] to set address ranges of interrogations.

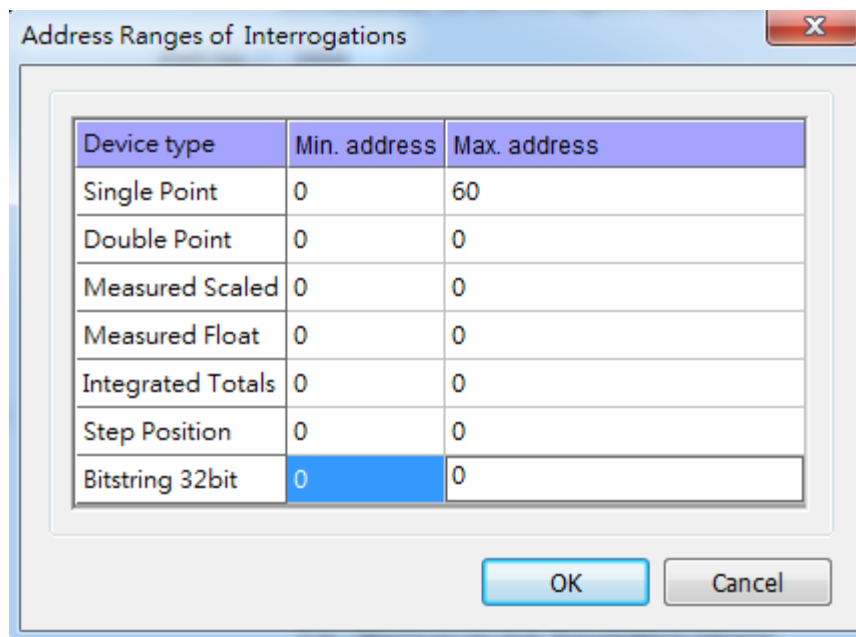


Periodically sends interrogation responses

Port no. : 2404

Interrogation Address Range...

As shown below, Single Point device type in addresses range from 0 to 60 will be sent to the Client.

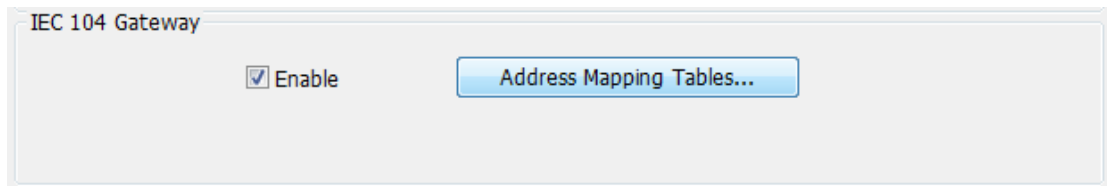


Device type	Min. address	Max. address
Single Point	0	60
Double Point	0	0
Measured Scaled	0	0
Measured Float	0	0
Integrated Totals	0	0
Step Position	0	0
Bitstring 32bit	0	0

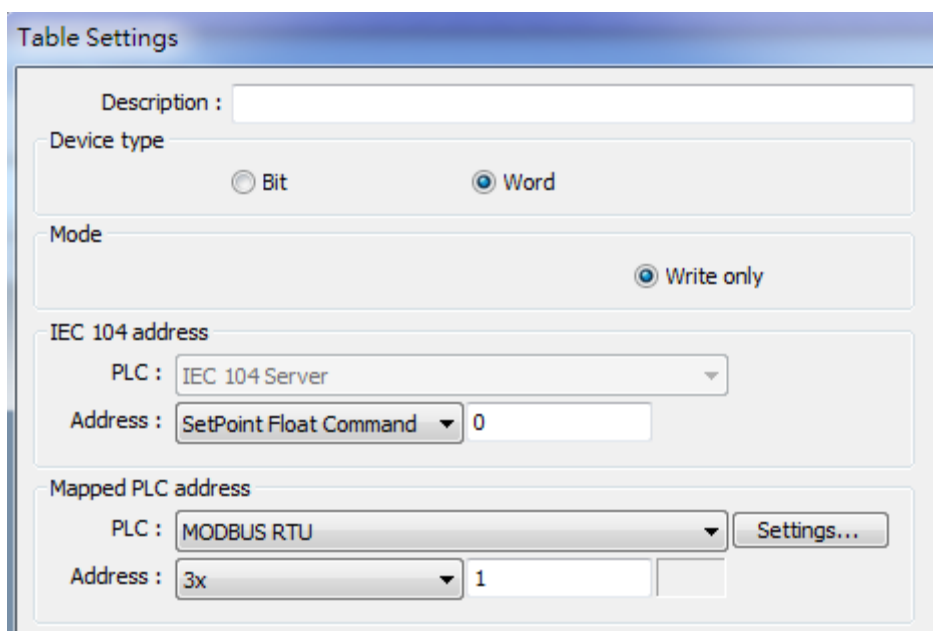
OK Cancel

IEC104 Gateway

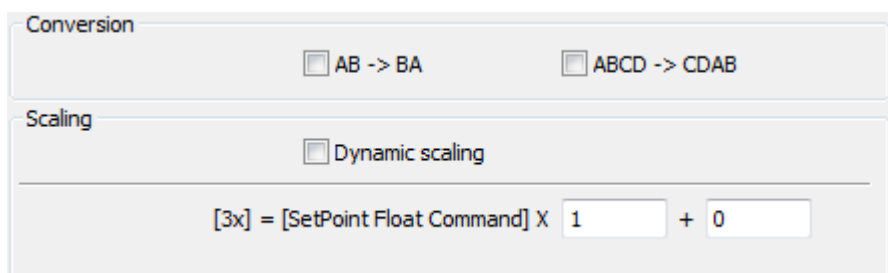
Set address mapping tables: Select [Enable] checkbox in IEC104 Gateway group box.



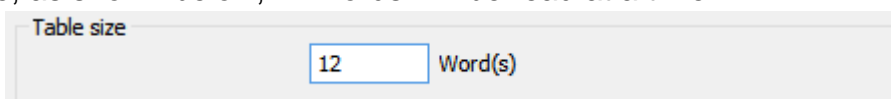
Click [Address Mapping Tables] to open Table Settings window, and map IEC 104 addresses with the ones of other devices. The applicable devices are local or Modbus PLCs.



Set scaling:



Set table size, as shown below, 12 words will be read at a time.



Wiring Diagram:

Diagram 1

Ethernet cable:



Inovance H2U/H1U

Website: <http://www.inovance.cn/>

HMI Setting:

Parameters	Recommended	Options	Notes
PLC type	Inovance H2U/H1U		
PLC I/F	RS485 4W		
Baud rate	9600	9600~19200	
Data bits	7	7 or 8	
Parity	Even	Even, Odd, None	
Stop bits	1	1 or 2	
PLC sta. no.	0		

Device Address:

Bit/Word	Device type	Format	Range	Memo
B	X	OOO	0 ~ 377	Input Bits
B	Y	OOO	0 ~ 377	Output Bits
B	M	DDDD	0 ~ 7999	Auxiliary Relay
B	T	DDD	0 ~ 255	Timer Relay
B	C	DDD	0 ~ 255	Counter Relay
B	SM	DDDD	8000 ~ 9999	Special Auxiliary Relay
B	D_Bit	DDDDdd	0 ~ 799915	
B	S	DDDD	0 ~ 4095	
W	TV	DDD	0 ~ 255	Timer Memory
W	CV	DDD	0 ~ 199	Counter Memory
W	D	DDDD	0 ~ 7999	Data Registers
DW	CV2	DDD	200 ~ 255	Counter Memory (32bit)
W	SD	DDDD	8000 ~ 9999	Special Data Register

Note: ddd: Decimal, hhh: Hexadecimal, ooo: Octal.

Each model of CPU is different, it is recommended to refer to PLC Manual Device List.

Wiring Diagram:

The following is the view from the soldering point of a connector.



Diagram 1

cMT Series	<i>cMT3151</i>
eMT Series	<i>eMT3070 / eMT3105 / eMT3120 / eMT3150</i>
MT-iE	<i>MT8070iE / MT6070iE / MT8100iE / MT8121iE / MT8150iE</i>
MT-XE	<i>MT8121XE / MT8150XE</i>

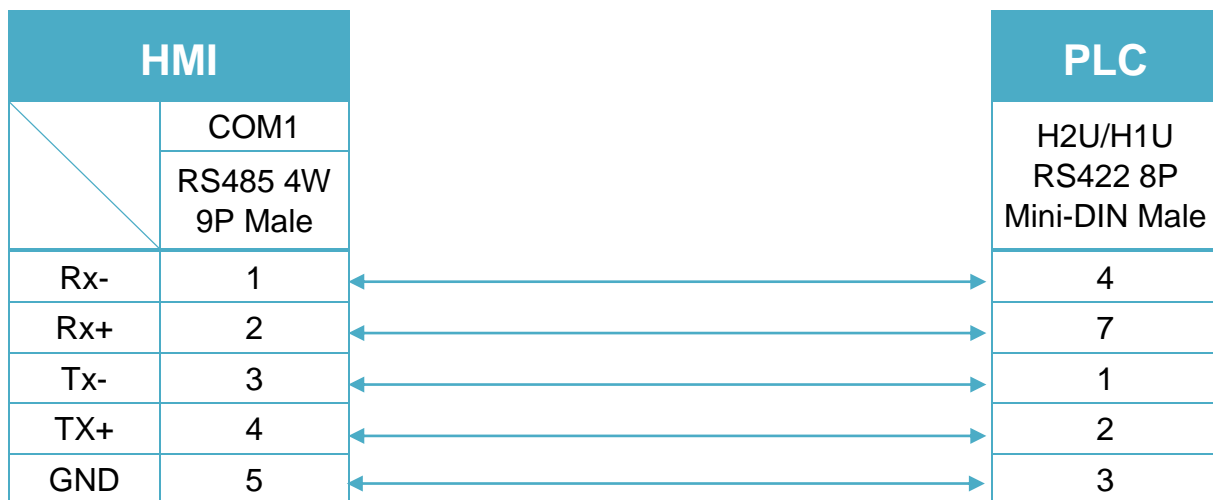


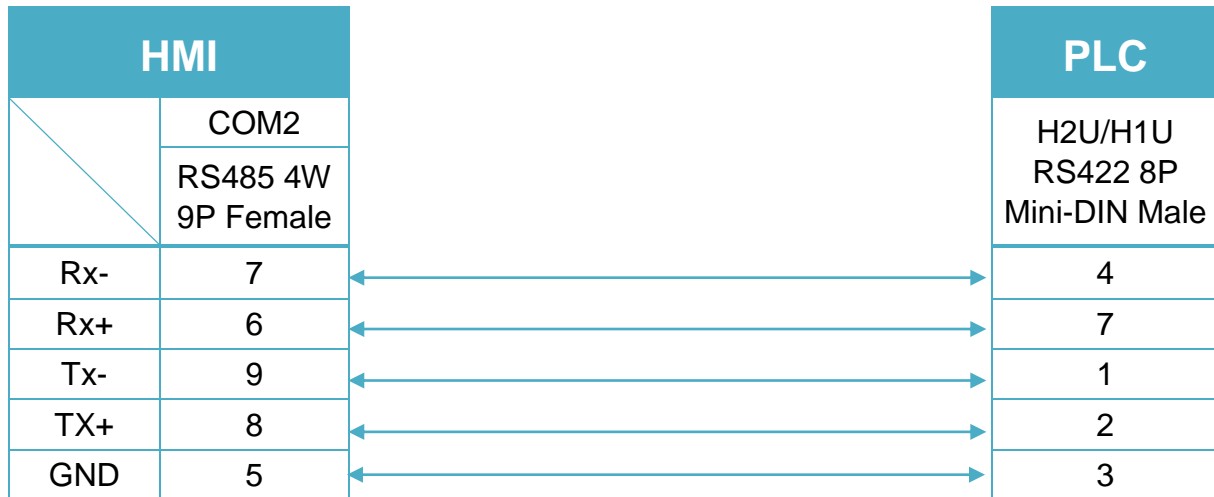
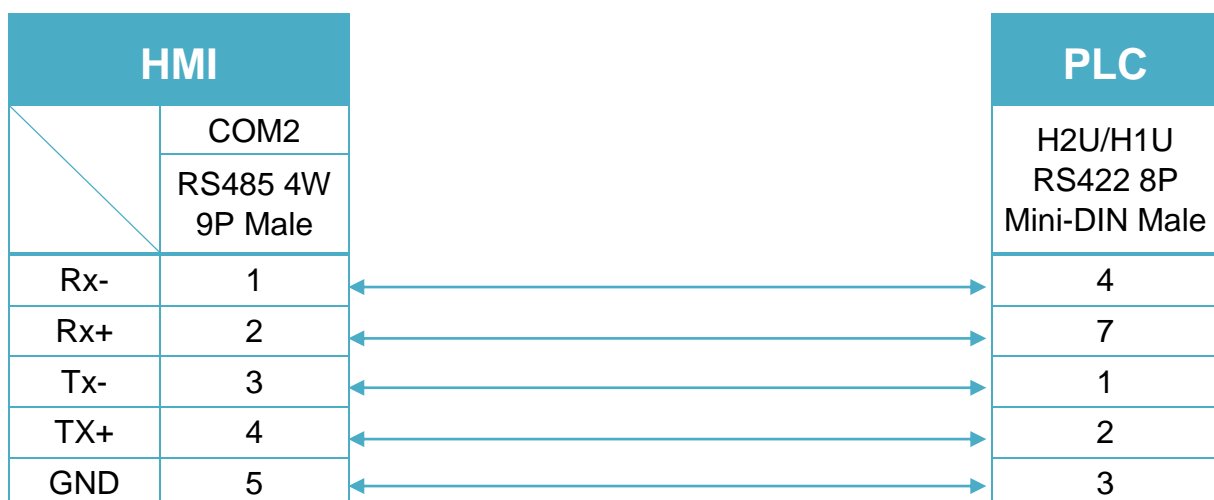
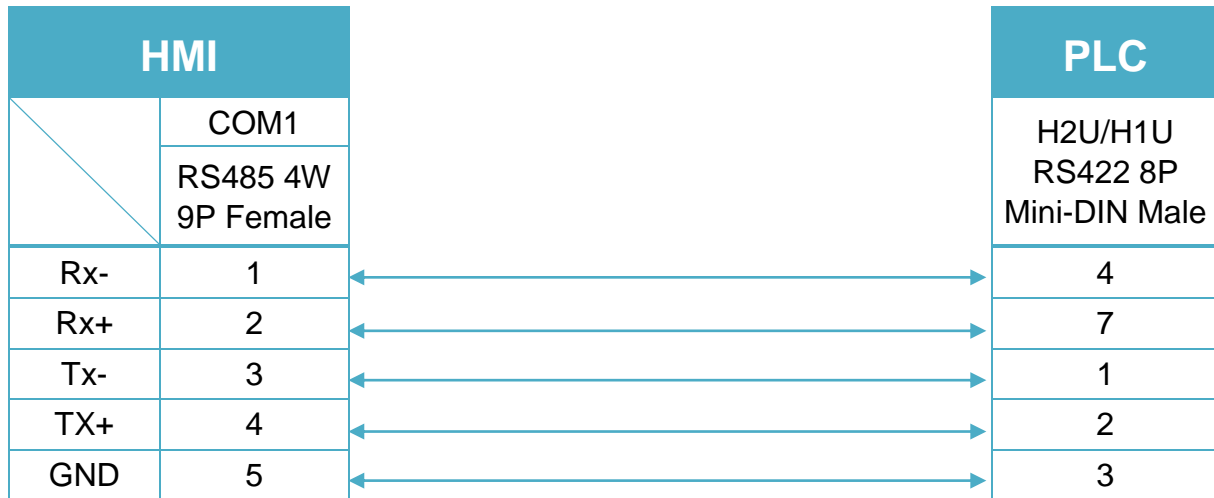
Diagram 2
cMT Series *cMT-SVR*
mTV *mTV*

Diagram 3
MT-iE *MT8071iE / MT6071iE / MT8072iE / MT6072iE / MT8073iE /
MT8101iE / MT8102iE / MT8103iE*
MT-XE *MT8090XE / MT8092XE*
MT-iP *MT6071iP / MT8071iP / MT6103iP*


Diagram 4
MT-iE *MT8050iE*
MT-iP *MT6051iP*


Inovance H3U Series

Website: <http://www.inovance.cn/>

HMI Setting:

Parameters	Recommended	Options	Notes
PLC type	Inovance H3U Series		
PLC I/F	RS485 4W		
Baud rate	9600	9600~19200	
Data bits	7	7 or 8	
Parity	Even	Even, Odd, None	
Stop bits	1	1 or 2	
PLC sta. no.	0		

Device Address:

Bit/Word	Device type	Format	Range	Memo
B	X	OOO	0 ~ 377	
B	Y	OOO	0 ~ 377	
B	M	DDDD	0 ~ 7999	
B	M8000	DDDD	8000 ~ 8511	
B	C_Bit	DDD	0 ~ 255	
B	T_Bit	DDD	0 ~ 511	
B	S	DDDD	0 ~ 4095	
B	SM	DDDD	0 ~ 1023	
W	C	DDD	0 ~ 199	
DW	C_Double	DDD	200 ~ 255	
W	T	DDD	0 ~ 511	
W	D	DDDD	0 ~ 7999	
W	D8000	DDDD	8000 ~ 8511	
W	SD	DDDD	0 ~ 1023	
W	R	DDDDD	0 ~ 32767	

Note: ddd: Decimal, hhh: Hexadecimal, ooo: Octal.

Wiring Diagram:

The following is the view from the soldering point of a connector.



Diagram 1

cMT Series	<i>cMT3151</i>
eMT Series	<i>eMT3070 / eMT3105 / eMT3120 / eMT3150</i>
MT-iE	<i>MT8070iE / MT6070iE / MT8100iE / MT8121iE / MT8150iE</i>
MT-XE	<i>MT8121XE / MT8150XE</i>

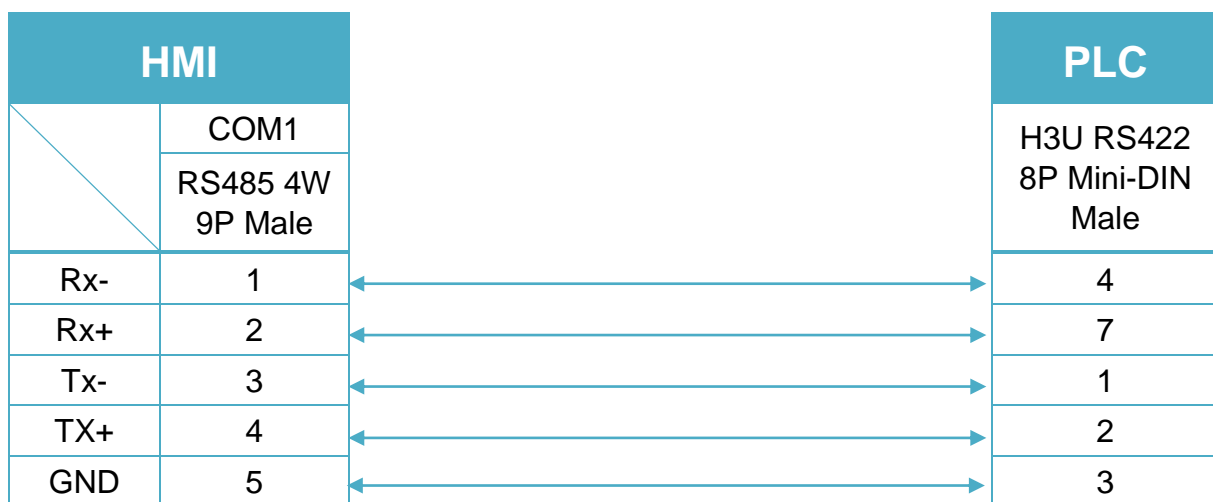


Diagram 2

cMT Series *cMT-SVR*

mTV *mTV*

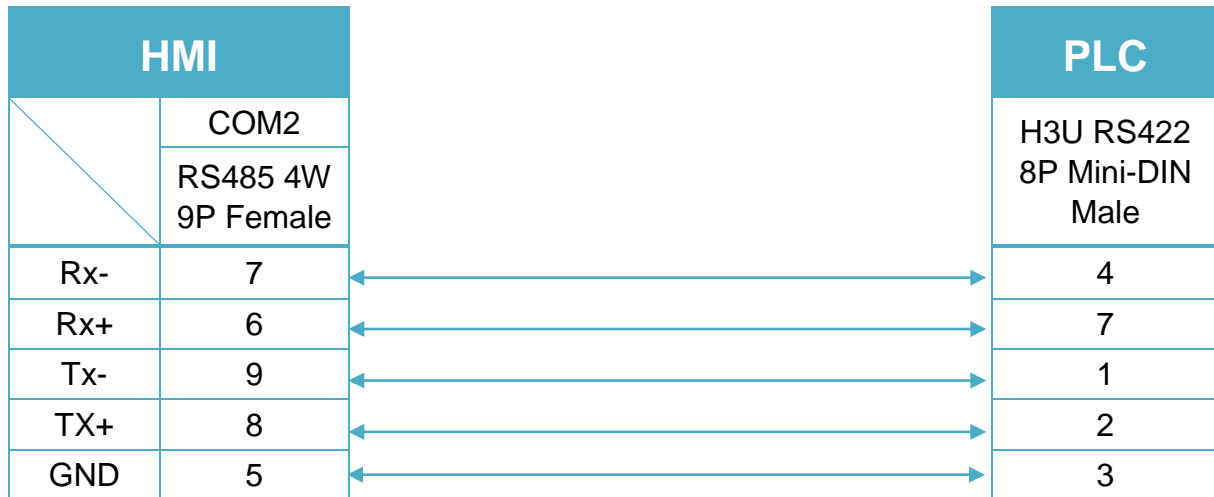


Diagram 3

MT-iE *MT8071iE / MT6071iE / MT8072iE / MT6072iE / MT8073iE /
MT8101iE / MT8102iE / MT8103iE*

MT-XE *MT8090XE / MT8092XE*

MT-iP *MT6071iP / MT8071iP / MT6103iP*

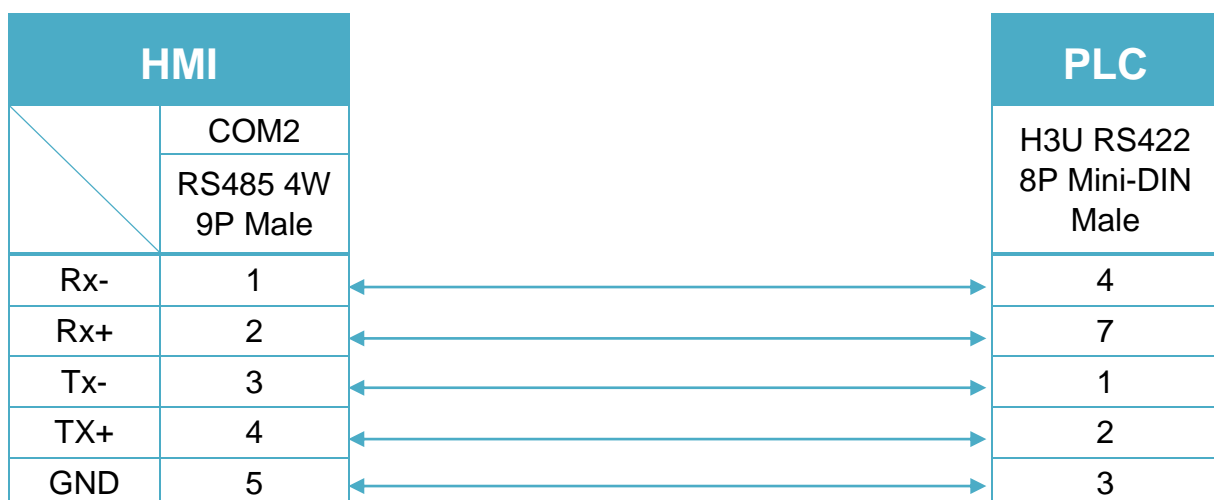
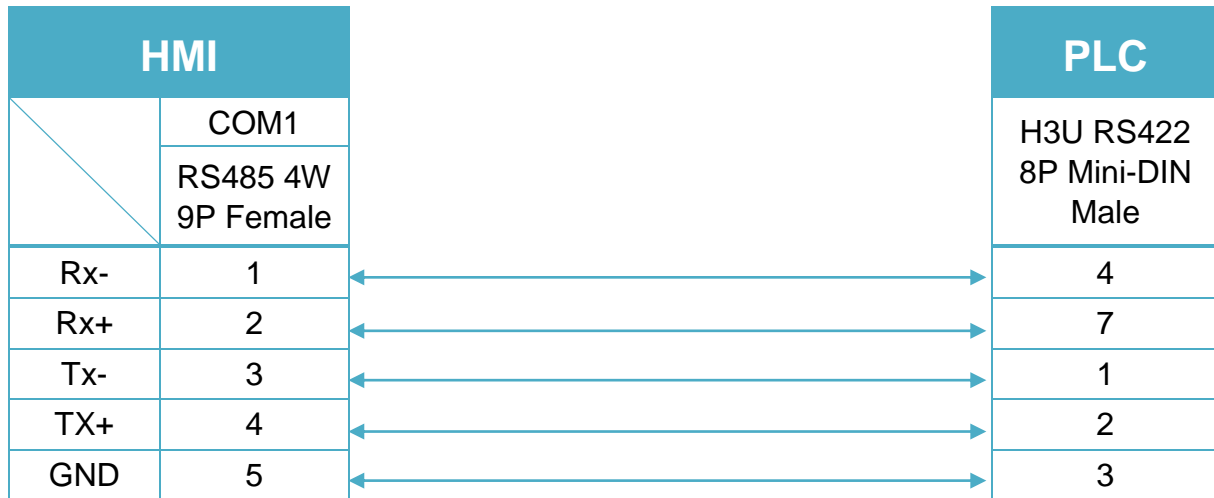


Diagram 4

MT-iE *MT8050iE*

MT-iP *MT6051iP*



Inovance H3U Series (Ethernet)

Website: <http://www.inovance.cn/>

HMI Setting:

Parameters	Recommended	Options	Notes
PLC type	Inovance H3U Series (Ethernet)		
PLC I/F	Ethernet		
Port no.	502		

Device Address:

Bit/Word	Device type	Format	Range	Memo
B	M	DDDD	0 ~ 7679	
B	M8000	DDDD	8000 ~ 8511	
B	SM	DDDD	0 ~ 1023	
B	S	DDDD	0 ~ 4095	
B	T_Bit	DDD	0 ~ 511	
B	C_Bit	DDD	0 ~ 255	
B	X	OOO	0 ~ 377	
B	Y	OOO	0 ~ 377	
W	D	DDDD	0 ~ 8511	
W	SD	DDDD	0 ~ 1023	
W	R	DDDDD	0 ~ 32767	
W	T	DDD	0 ~ 255	
W	C	DDD	0 ~ 199	
DW	C_Double	DDD	200 ~ 255	

Wiring Diagram:

Diagram 1

Ethernet cable:



Invt GD5000 Series (Ethernet)

Supported series: Invt GD5000 Series

Website: <http://www.invt.com/>

HMI Setting:

Parameters	Recommended	Options	Notes
PLC type	Invt GD5000 Series (Ethernet)		Use UDP
PLC I/F	Ethernet		
Port no.	6000		

Device Address:

Bit/Word	Device type	Format	Range	Memo
W	Reg_A	HHHH	0 ~ FFFF	
W	Reg_M	HHHH	0 ~ FFFF	

Wiring Diagram:

Diagram 1

Ethernet cable:



JTEKT Toyopuc CMP-Link (Ethernt)

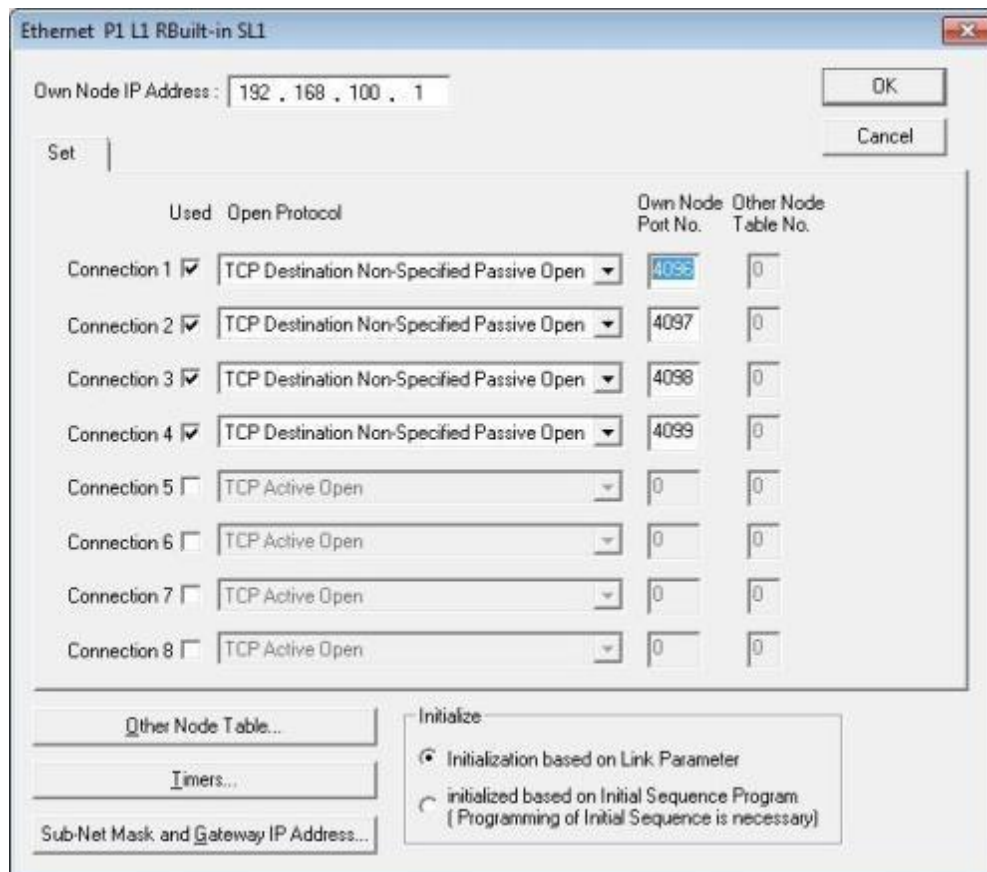
Supported series: Toyopuc PC10G

Website: <http://www.jtekt.co.jp/>

HMI Setting:

Parameters	Recommended	Options	Notes
PLC type	JTEKT Toyopuc CMP-Link (Ethernt)		
PLC I/F	Ethernet		
Port no.	4096	1024 ~ 65534	

PLC Setting:



Ethernet P1 L1 RBuilt-in SL1

Own Node IP Address: 192 . 168 . 100 . 1

OK
Cancel

Set

Used	Open Protocol	Own Node Port No.	Other Node Table No.
<input checked="" type="checkbox"/>	TCP Destination Non-Specified Passive Open	4096	0
<input checked="" type="checkbox"/>	TCP Destination Non-Specified Passive Open	4097	0
<input checked="" type="checkbox"/>	TCP Destination Non-Specified Passive Open	4098	0
<input checked="" type="checkbox"/>	TCP Destination Non-Specified Passive Open	4099	0
<input type="checkbox"/>	TCP Active Open	0	0
<input type="checkbox"/>	TCP Active Open	0	0
<input type="checkbox"/>	TCP Active Open	0	0
<input type="checkbox"/>	TCP Active Open	0	0

Other Node Table...
Timers...
Sub-Net Mask and Gateway IP Address...

Initialize

- Initialization based on Link Parameter
- initialized based on Initial Sequence Program (Programming of Initial Sequence is necessary)

Device Address:

Bit/Word	Device type	Format	Range	Memo
B	1X	HHh	0 ~ 7FF	
B	2X	HHh	0 ~ 7FF	
B	3X	HHh	0 ~ 7FF	
B	1Y	HHh	0 ~ 7FF	
B	2Y	HHh	0 ~ 7FF	
B	3Y	HHh	0 ~ 7FF	
B	1M	HHh	0 ~ 7FF	
B	2M	HHh	0 ~ 7FF	
B	3M	HHh	0 ~ 7FF	
B	1K	HHh	0 ~ 7FF	
B	2K	HHh	0 ~ 7FF	
B	3K	HHh	0 ~ 7FF	
B	1L	HHh	0 ~ 7FF	
B	2L	HHh	0 ~ 7FF	
B	3L	HHh	0 ~ 7FF	
B	1V	Hh	0 ~ FF	
B	2V	Hh	0 ~ FF	
B	3V	Hh	0 ~ FF	
B	1T	HHh	0 ~ 7FF	
B	2T	HHh	0 ~ 7FF	
B	3T	HHh	0 ~ 7FF	
B	1C	HHh	0 ~ 7FF	
B	2C	HHh	0 ~ 7FF	
B	3C	HHh	0 ~ 7FF	
B	1S	HHHh	0 ~ 3FFF	
B	2S	HHHh	0 ~ 3FFF	
B	3S	HHHh	0 ~ 3FFF	
B	1N	HHHh	0 ~ 1FFF	
B	2N	HHHh	0 ~ 1FFF	
B	3N	HHHh	0 ~ 1FFF	
B	1D	HHHHh	0 ~ 2FFFF	
B	2D	HHHHh	0 ~ 2FFFF	
B	3D	HHHHh	0 ~ 2FFFF	
B	1R	HHHh	0 ~ 7FFF	
B	2R	HHHh	0 ~ 7FFF	

Bit/Word	Device type	Format	Range	Memo
B	3R	HHHh	0 ~ 7FFF	
B	B	HHHHh	0 ~ 1FFFF	
B	H	HHHh	0 ~ 7FFF	
B	U	HHHHHh	0 ~ 1FFFFF	
B	EX	HHh	0 ~ 7FF	
B	EY	HHh	0 ~ 7FF	
B	EM	HHHh	0 ~ 1FFF	
B	EK	HHh	0 ~ FFF	
B	EL	HHHh	0 ~ 1FFF	
B	EV	HHHh	0 ~ 1FFF	
B	ET	HHh	0 ~ 7FF	
B	EC	HHh	0 ~ 7FF	
B	ES	HHHh	0 ~ 7FFF	
B	EN	HHHh	0 ~ 7FFF	
B	GX	HHHh	0 ~ FFFF	
B	GY	HHHh	0 ~ FFFF	
B	GM	HHHh	0 ~ FFFF	
B	EB	HHHHHh	0 ~ 3FFFFFF	
B	FR	HHHHHh	0 ~ 1FFFFFF	
W	1XW	HH	0 ~ 7F	
W	2XW	HH	0 ~ 7F	
W	3XW	HH	0 ~ 7F	
W	1YW	HH	0 ~ 7F	
W	2YW	HH	0 ~ 7F	
W	3YW	HH	0 ~ 7F	
W	1MW	HH	0 ~ 7F	
W	2MW	HH	0 ~ 7F	
W	3MW	HH	0 ~ 7F	
W	1KW	HH	0 ~ 2F	
W	2KW	HH	0 ~ 2F	
W	3KW	HH	0 ~ 2F	
W	1LW	HH	0 ~ 7F	
W	2LW	HH	0 ~ 7F	
W	3LW	HH	0 ~ 7F	
W	1VW	H	0 ~ F	
W	2VW	H	0 ~ F	
W	3VW	H	0 ~ F	

Bit/Word	Device type	Format	Range	Memo
W	1TW	HH	0 ~ 1F	
W	2TW	HH	0 ~ 1F	
W	3TW	HH	0 ~ 1F	
W	1CW	HH	0 ~ 1F	
W	2CW	HH	0 ~ 1F	
W	3CW	HH	0 ~ 1F	
W	1SW	HHH	0 ~ 3FF	
W	2SW	HHH	0 ~ 3FF	
W	3SW	HHH	0 ~ 3FF	
W	1NW	HHH	0 ~ 1FF	
W	2NW	HHH	0 ~ 1FF	
W	3NW	HHH	0 ~ 1FF	
W	1DW	HHHH	0 ~ 2FFF	
W	2DW	HHHH	0 ~ 2FFF	
W	3DW	HHHH	0 ~ 2FFF	
W	1RW	HHH	0 ~ 7FF	
W	2RW	HHH	0 ~ 7FF	
W	3RW	HHH	0 ~ 7FF	
W	BW	HHHH	0 ~ 1FFF	
W	HW	HHH	0 ~ 7FF	
W	UW	HHHHH	0 ~ 1FFFF	
W	EXW	HH	0 ~ 7F	
W	EYW	HH	0 ~ 7F	
W	EMW	HHH	0 ~ 1FF	
W	EKW	HH	0 ~ FF	
W	ELW	HHH	0 ~ 1FF	
W	EVW	HHH	0 ~ 1FF	
W	ETW	HH	0 ~ 7F	
W	ECW	HH	0 ~ 7F	
W	ESW	HHH	0 ~ 7FF	
W	ENW	HHH	0 ~ 7FF	
W	GXW	HHH	0 ~ FFF	
W	GYW	HHH	0 ~ FFF	
W	GMW	HHH	0 ~ FFF	
W	WT	H	0 ~ 6	
W	EBW	HHHHH	0 ~ 3FFFF	
W	FRW	HHHHH	0 ~ 1FFFF	

Wiring Diagram:

Diagram 1

Ethernet cable:



JTEKT Toyopuc PCk05

Supported Series: JTEKT Toyopuc PCk05

Website: <http://www.jtekt.co.jp/>

HMI Setting:

Parameters	Recommended	Options	Notes
PLC type	JTEKT Toyopuc PCk05		
PLC I/F	RS232		
Baud rate	9600	9600, 19200, 38400	
Data bits	8		
Parity	Odd	Odd, Even, None	
Stop bits	1	1, 2	
PLC sta. no.	N/A		

Device Address:

Bit/Word	Device type	Format	Range	Memo
B	K_Bit	Hh	0 ~ ff	
B	V_Bit	Hh	0 ~ ff	
B	T_Bit	Hh	0 ~ 7f	
B	1C_Bit	Hh	0 ~ 7f	
B	L_Bit	HHh	0 ~ 7ff	
B	X_Bit	Hh	0 ~ ff	
B	4Y_Bit	Hh	0 ~ ff	
B	M_Bit	Hh	0 ~ ff	
B	4M_Bit	Hh	0 ~ ff	
B	S_Bit	HHh	0 ~ 7ff	
B	N_Bit	HHh	0 ~ 7ff	
B	1N_Bit	HHh	0 ~ 7ff	
B	D_Bit	HHHh	0 ~ cfff	
W	K	H	0 ~ f	
W	V	H	0 ~ f	
W	T	H	0 ~ 7	
W	1C	H	0 ~ 7	
W	L	HH	0 ~ 7f	
W	X	H	0 ~ f	
W	4Y	H	0 ~ f	
W	M	H	0 ~ f	

Bit/Word	Device type	Format	Range	Memo
W	4M	H	0 ~ f	
W	S	HH	0 ~ 7f	
W	N	HH	0 ~ 7f	
W	1N	HH	0 ~ 7f	
W	D	HHH	0 ~ cff	

Wiring Diagram:

RS232 CPU Port1 and Port2 (Diagram 1 ~ Diagram 3)

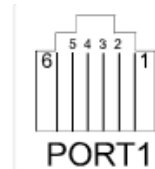


Diagram 1

cMT Series

cMT3151

eMT Series

eMT3070 / eMT3105 / eMT3120 / eMT3150

MT-iE

MT8073iE / MT8102iE

MT-XE

MT8092XE

MT-iP

MT6103iP

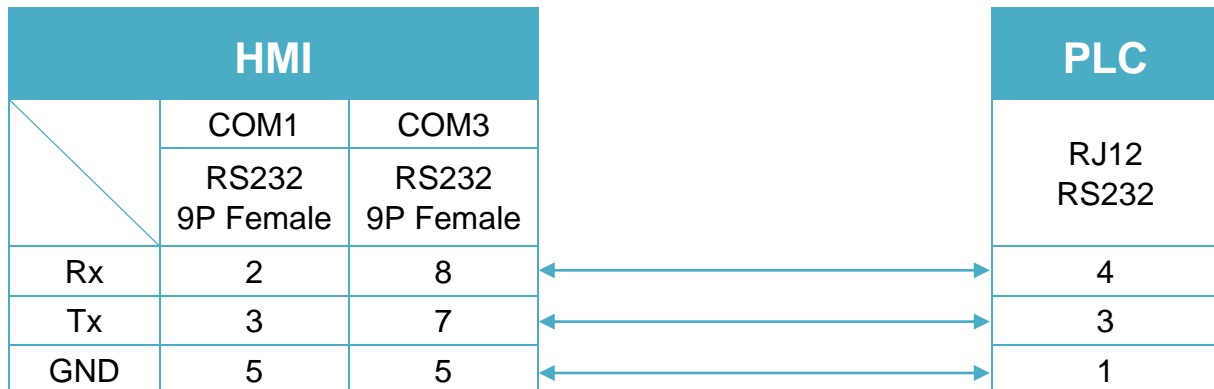


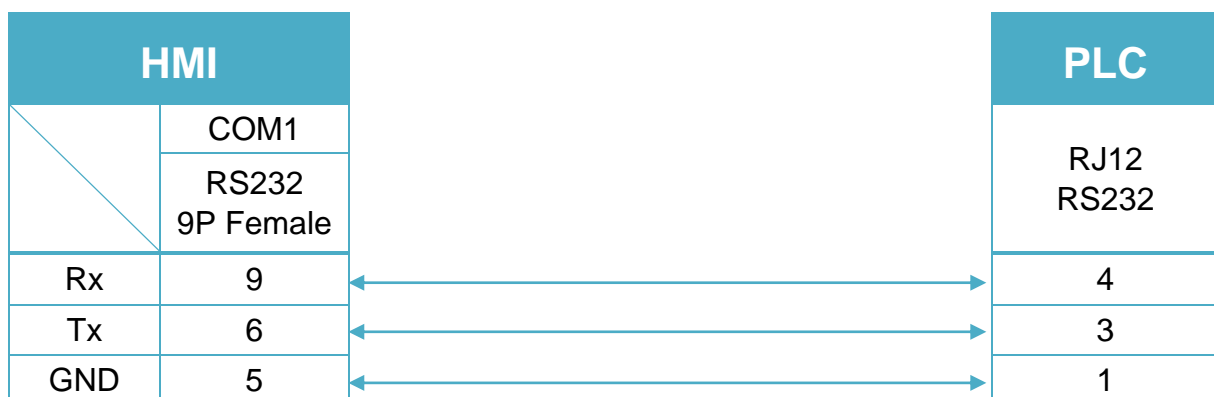
Diagram 2

cMT Series	cMT-SVR
mTV	mTV
MT-iE	MT8070iE / MT6070iE / MT8100iE / MT8121iE / MT8150iE / MT8071iE / MT6071iE / MT8072iE / MT6072iE / MT8073iE / MT8101iE / MT8102iE / MT8103iE
MT-XE	MT8121XE / MT8150XE / MT8090XE



Diagram 3

MT-iE	MT8050iE
MT-iP	MT6051iP / MT6071iP / MT8071iP



JTEKT Toyopuc PCk06

Supported Series: JTEKT Toyopuc PCk06

Website: <http://www.jtekt.co.jp/>

HMI Setting:

Parameters	Recommended	Options	Notes
PLC type	JTEKT Toyopuc PCk06		
PLC I/F	RS232	RS232	
Baud rate	9600	9600, 19200, 38400	
Data bits	8		
Parity	Odd	Odd, Even, None	
Stop bits	1	1, 2	
PLC sta. no.	N/A		

Device Address:

Bit/Word	Device type	Format	Range	Memo
B	K_Bit	Hh	0 ~ ff	
B	1K_Bit	Hh	0 ~ ff	
B	V_Bit	Hh	0 ~ ff	
B	T_Bit	Hh	0 ~ ff	
B	1C_Bit	Hh	0 ~ 7f	
B	L_Bit	HHh	0 ~ 7ff	
B	X_Bit	Hh	0 ~ ff	
B	1X_Bit	Hh	0 ~ ff	
B	4Y_Bit	Hh	0 ~ ff	
B	5Y_Bit	Hh	0 ~ ff	
B	M_Bit	Hh	0 ~ ff	
B	1M_Bit	Hh	0 ~ ff	
B	4M_Bit	Hh	0 ~ ff	
B	S_Bit	HHHh	0 ~ 3fff	
B	N_Bit	HHh	0 ~ fff	
B	1N_Bit	HHh	0 ~ 7ff	
B	D_Bit	HHHh	0 ~ cfff	
B	1D_Bit	HHHh	0 ~ ffff	
W	K	H	0 ~ f	
W	1K	H	0 ~ f	
W	V	H	0 ~ f	

Bit/Word	Device type	Format	Range	Memo
W	T	H	0 ~ f	
W	1C	H	0 ~ 7	
W	L	HH	0 ~ 7f	
W	X	H	0 ~ f	
W	1X	H	0 ~ f	
W	4Y	H	0 ~ f	
W	5Y	H	0 ~ f	
W	M	H	0 ~ f	
W	1M	H	0 ~ f	
W	4M	H	0 ~ f	
W	S	HHH	0 ~ 3ff	
W	N	HH	0 ~ ff	
W	1N	HH	0 ~ 7f	
W	D	HHH	0 ~ cff	
W	1D	HHH	0 ~ fff	

Wiring Diagram:

RS232 CPU Port1 (Diagram 1 ~ Diagram 3)

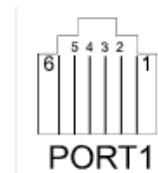


Diagram 1

cMT Series

cMT3151

eMT Series

eMT3070/ eMT3105 / eMT3120 / eMT3150

MT-iE

MT8073iE / MT8102iE

MT-XE

MT8092XE

MT-iP

MT6103iP

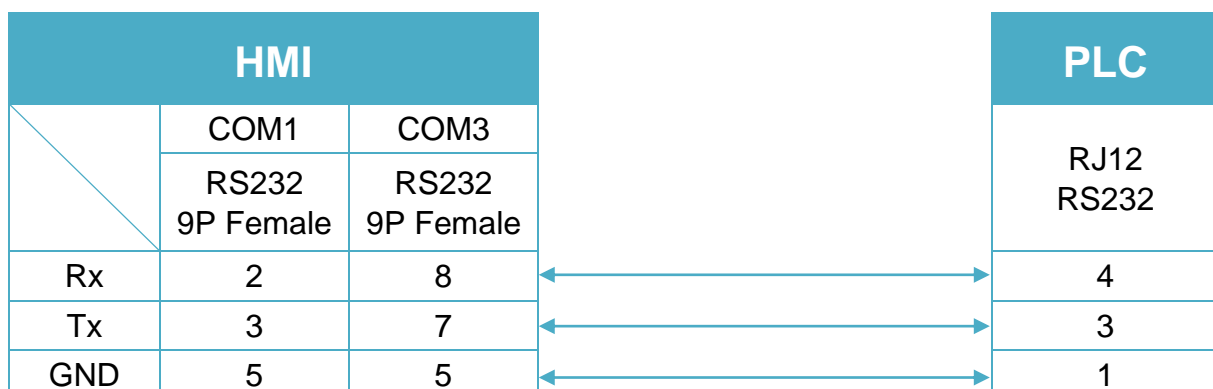


Diagram 2

cMT Series	cMT-SVR
mTV	mTV
MT-iE	MT8070iE / MT6070iE / MT8100iE / MT8121iE / MT8150iE / MT8071iE / MT6071iE / MT8072iE / MT6072iE / MT8073iE / MT8101iE / MT8102iE / MT8103iE
MT-XE	MT8121XE / MT8150XE / MT8090XE

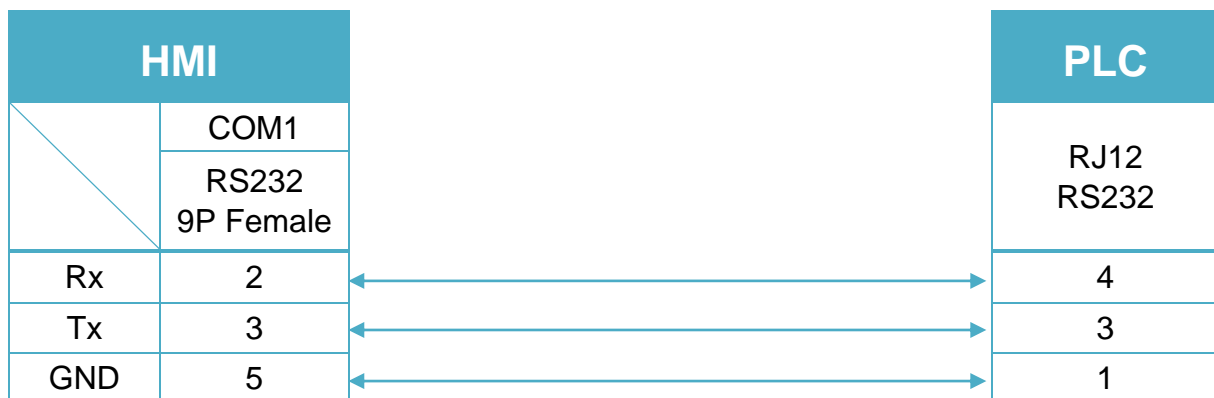
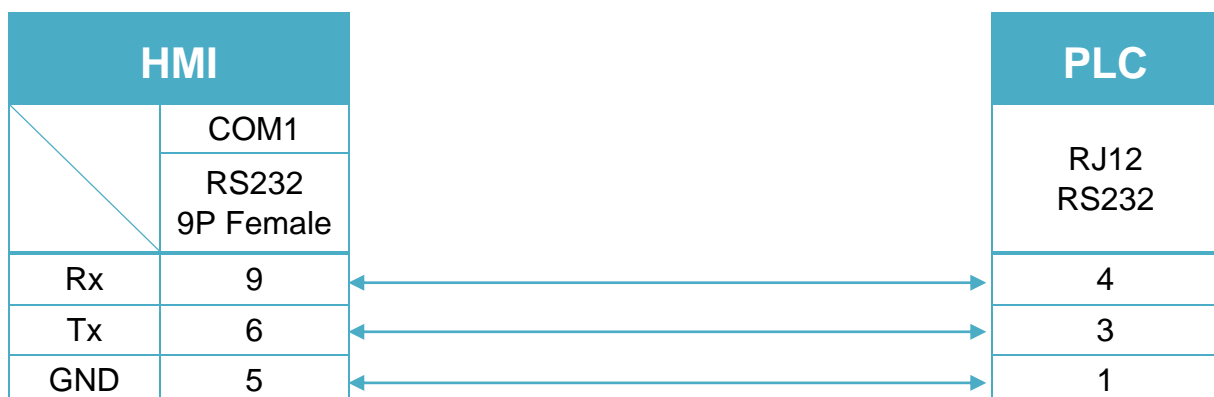


Diagram 3

MT-iE	MT8050iE
MT-iP	MT6051iP / MT6071iP / MT8071iP



RS232 CPU Port2 (Diagram 4 ~ Diagram 6)

Diagram 4

cMT Series	<i>cMT3151</i>
eMT Series	<i>eMT3070 / eMT3105 / eMT3120 / eMT3150</i>
MT-iE	<i>MT8073iE / MT8102iE</i>
MT-XE	<i>MT8092XE</i>
MT-iP	<i>MT6103iP</i>

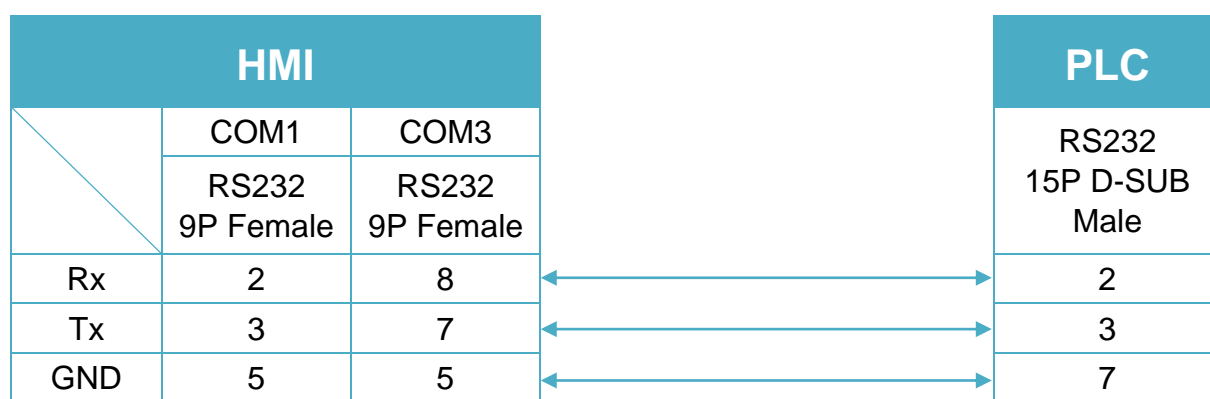


Diagram 5

cMT Series	<i>cMT-SVR</i>
mTV	<i>mTV</i>
MT-iE	<i>MT8070iE / MT6070iE / MT8100iE / MT8121iE / MT8150iE / MT8071iE / MT6071iE / MT8072iE / MT6072iE / MT8073iE / MT8101iE / MT8102iE / MT8103iE</i>
MT-XE	<i>MT8121XE / MT8150XE / MT8090XE</i>

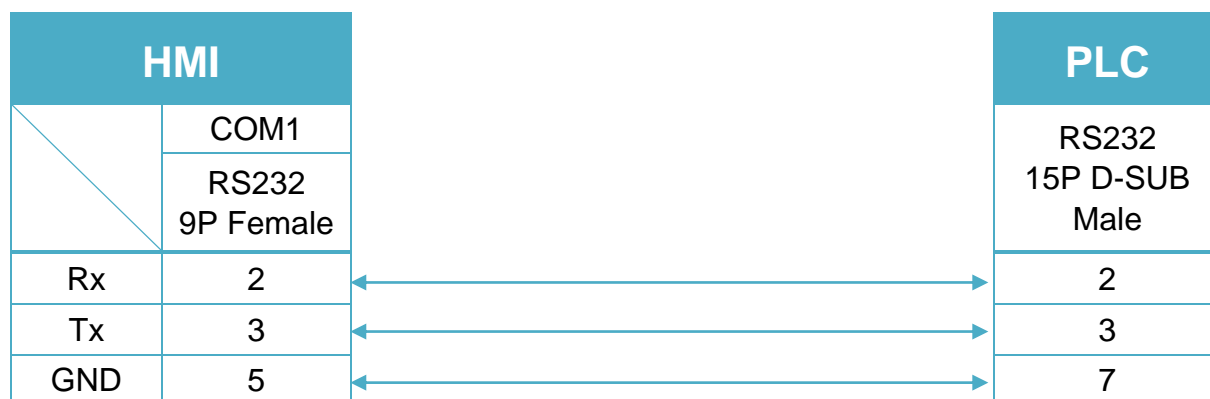
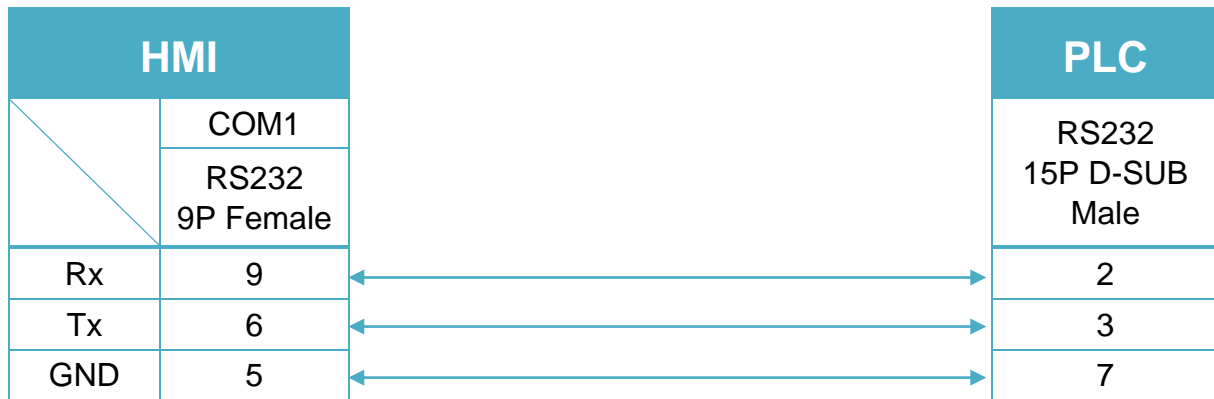


Diagram 6
MT-iE
MT8050iE
MT-iP
MT6051iP / MT6071iP / MT8071iP


Justfi Controller

Supported Series: Justfi weighing instruments, Industrial Batching Controller supports XK31CB4, XK31CB6.

Website: <http://www.justfi.com>

HMI Setting:

Parameters	Recommended	Options	Notes
PLC type	Justfi controller		
PLC I/F	RS232		
Baud rate	9600	9600, 19200	
Data bits	7	7 or 8	
Parity	Even	Even, Odd, None	
Stop bits	1	1 or 2	
PLC sta. no.	1		

Device Address:

Bit/Word	Device type	Format	Range	Memo
W	Func	DD	0 ~ 99	Read / Write
DW	Func_DW	DD	0 ~ 99	Read / Write
W	RW	H	0	Weight (read only)
W	RF	H	0	Read result (read only)
W	RT	H	0	Read total (read only)
W	RG	H	0	Read prescription group
W	RC	H	0	Circle
W	RB	H	0	Read status (read only)
W	MZ	H	0	Zero (write only)
W	MT	H	0	Tare (write only)
W	CT	H	0	Clear tare (write only)
W	DT	H	0	Clear total (write only)
W	BB	H	0	Start (write only)
W	HB	H	0	Stop (write only)
W	BD	H	0	Discharge (write only)
W	RP1t RP6F	H	0	Read/Write recipe

Wiring Diagram:

Diagram 1

cMT Series	<i>cMT3151</i>
eMT Series	<i>eMT3070 / eMT3105 / eMT3120 / eMT3150</i>
MT-iE	<i>MT8073iE / MT8102iE</i>
MT-XE	<i>MT8092XE</i>
MT-iP	<i>MT6103iP</i>

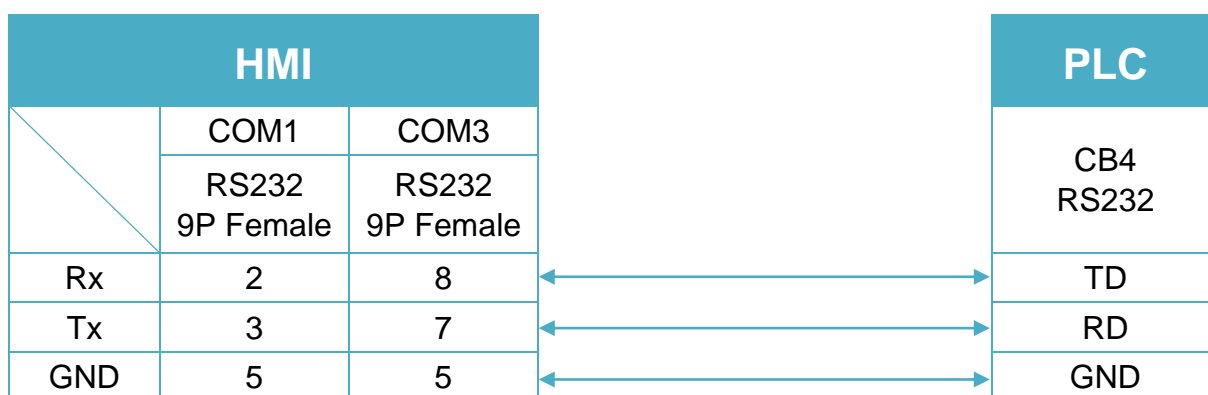


Diagram 2

cMT Series	<i>cMT-SVR</i>
mTV	<i>mTV</i>
MT-iE	<i>MT8070iE / MT6070iE / MT8100iE / MT8121iE / MT8150iE / MT8071iE / MT6071iE / MT8072iE / MT6072iE / MT8073iE / MT8101iE / MT8102iE / MT8103iE</i>
MT-XE	<i>MT8121XE / MT8150XE / MT8090XE</i>

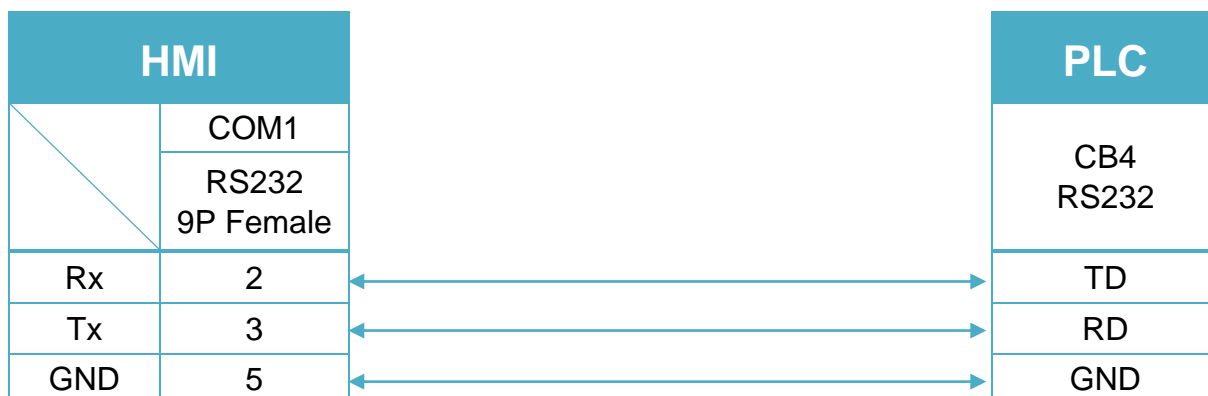
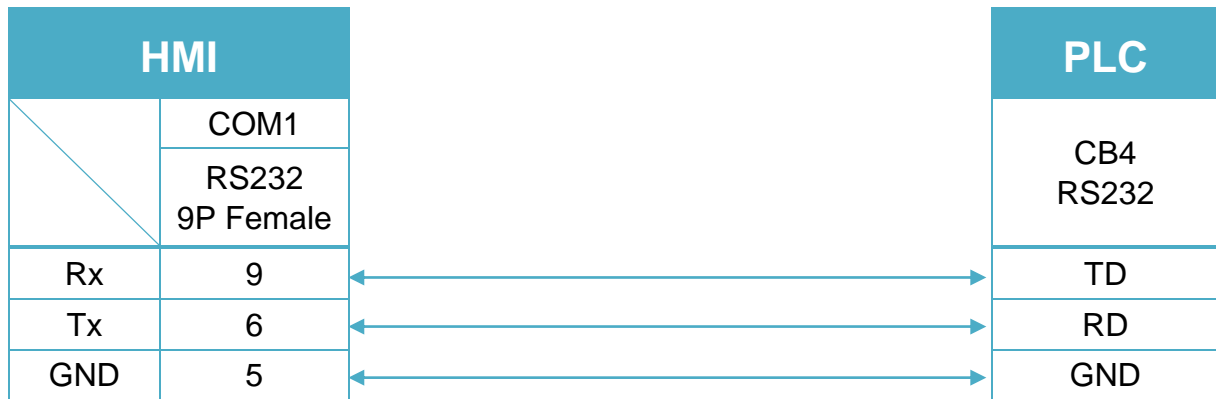


Diagram 3

MT-iE
MT8050iE
MT-iP
MT6051iP / MT6071iP / MT8071iP


Kernel sistemi DMX Series

Supported Series: Kernel sistemi DMX 30

Website: <http://www.kernelgroup.it/>

HMI Setting:

Parameters	Recommended	Options	Notes
PLC type	Kernel sistemi DMX Series		
PLC I/F	RS232	RS485	
Baud rate	19200	9600	
Data bits	8		
Parity	None		
Stop bits	1		
PLC sta. no.	1		Must match the PLC port setting

Device Address:

Bit/Word	Device type	Format	Range	Memo
W	D	HHHH	0 ~ ffff	

Wiring Diagram:

Diagram 1

cMT Series	<i>cMT3151</i>
eMT Series	<i>eMT3070 / eMT3105 / eMT3120 / eMT3150</i>
MT-iE	<i>MT8073iE / MT8102iE</i>
MT-XE	<i>MT8092XE</i>
MT-iP	<i>MT6103iP</i>

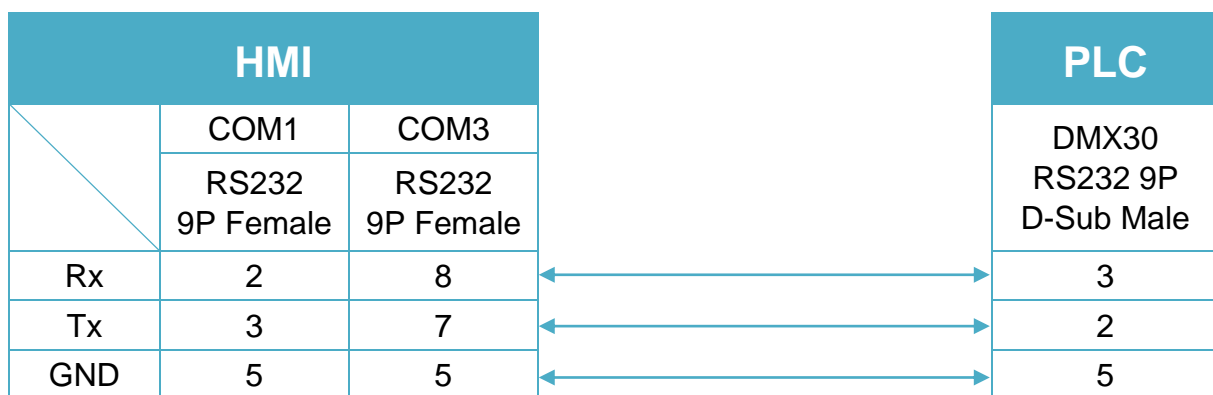


Diagram 2

cMT Series	<i>cMT-SVR</i>
mTV	<i>mTV</i>
MT-iE	<i>MT8070iE / MT6070iE / MT8100iE / MT8121iE / MT8150iE / MT8071iE / MT6071iE / MT8072iE / MT6072iE / MT8073iE / MT8101iE / MT8102iE / MT8103iE</i>
MT-XE	<i>MT8121XE / MT8150XE / MT8090XE</i>

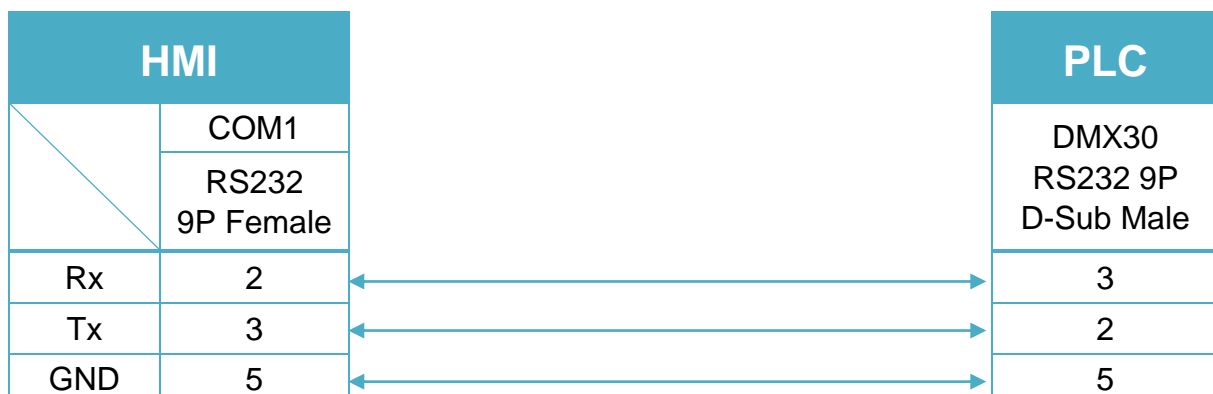
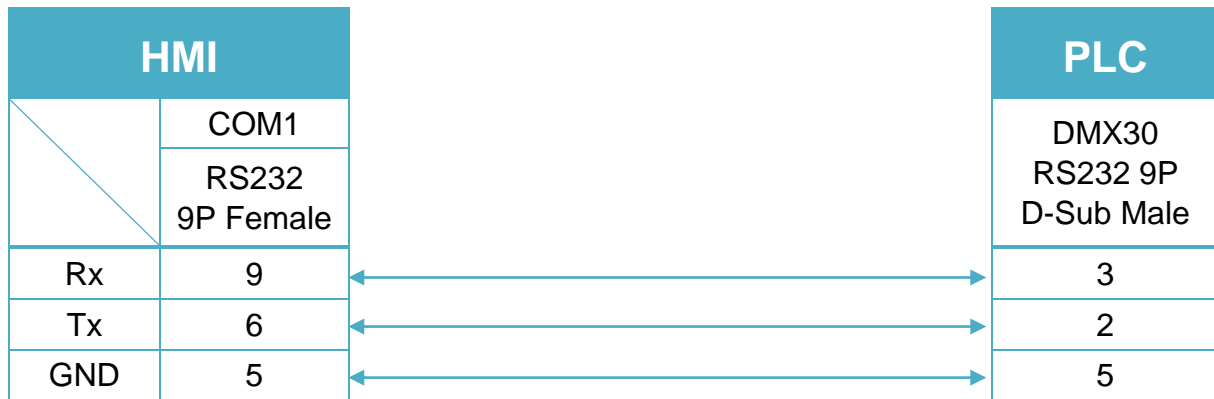


Diagram 3

MT-iE
MT8050iE
MT-iP
MT6051iP / MT6071iP / MT8071iP


KEYENCE KV-10/16/24/40/80/Visual KV Series

Supported Series: KEYENCE KV series, KV16~80

Website: <http://www.keyence.com/>

HMI Setting:

Parameters	Recommended	Options	Notes
PLC type	KEYENCE KV-10/16/24/40/80/Visual KV Series		
PLC I/F	RS232	RS232	
Baud rate	9600		
Data bits	8		
Parity	Even		
Stop bits	1		
PLC sta. no.	0		

Device Address:

Bit/Word	Device type	Format	Range	Memo
B	RLY	DDDdd0*	0 ~ 655150*	dd:0 ~ 15
B	DM_Bit	DDDDh	0 ~ 65535f	
W	DM	DDDDD	0 ~ 65535	
W	TM	DDDD	0 ~ 8999	
W	T	DDDD	0 ~ 9999	
W	T_Curr	DDDD	0 ~ 9999	Timer_Current
W	T_Preset	DDDD	0 ~ 9999	
W	C	DDDD	0 ~ 9999	
W	C_Curr	DDDD	0 ~ 9999	Counter_Current
W	C_Preset	DDDD	0 ~ 9999	

Note:*

If Relay (bit) register is used, please place a zero at the end of the address.

For example, to read Relay (bit) 100, the address is written as "1000".

Wiring Diagram:

RS232 CPU Port (Diagram 1 ~ Diagram 3)

Diagram 1

cMT Series	<i>cMT3151</i>
eMT Series	<i>eMT3070 / eMT3105 / eMT3120 / eMT3150</i>
MT-iE	<i>MT8073iE / MT8102iE</i>
MT-XE	<i>MT8092XE</i>
MT-iP	<i>MT6103iP</i>

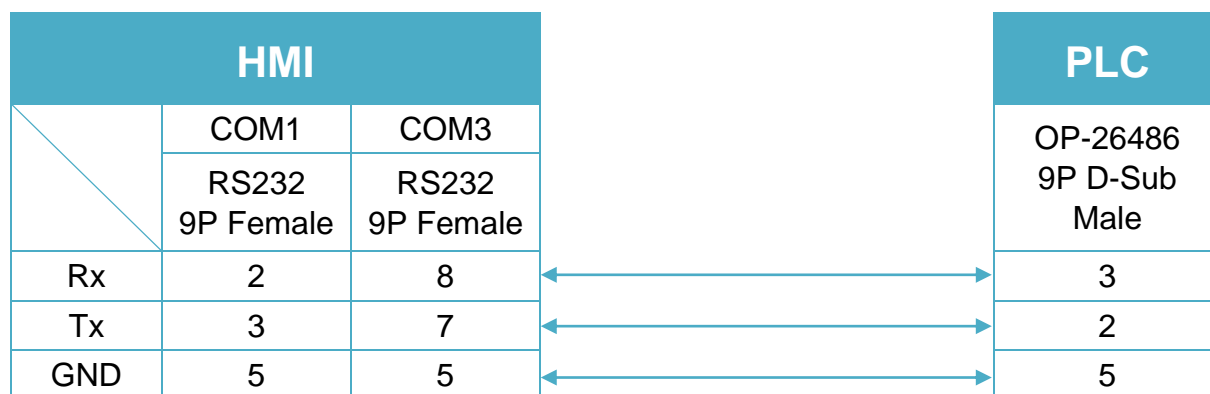


Diagram 2

cMT Series	cMT-SVR
mTV	mTV
MT-iE	MT8070iE / MT6070iE / MT8100iE / MT8121iE / MT8150iE / MT8071iE / MT6071iE / MT8072iE / MT6072iE / MT8073iE / MT8101iE / MT8102iE / MT8103iE
MT-XE	MT8121XE / MT8150XE / MT8090XE

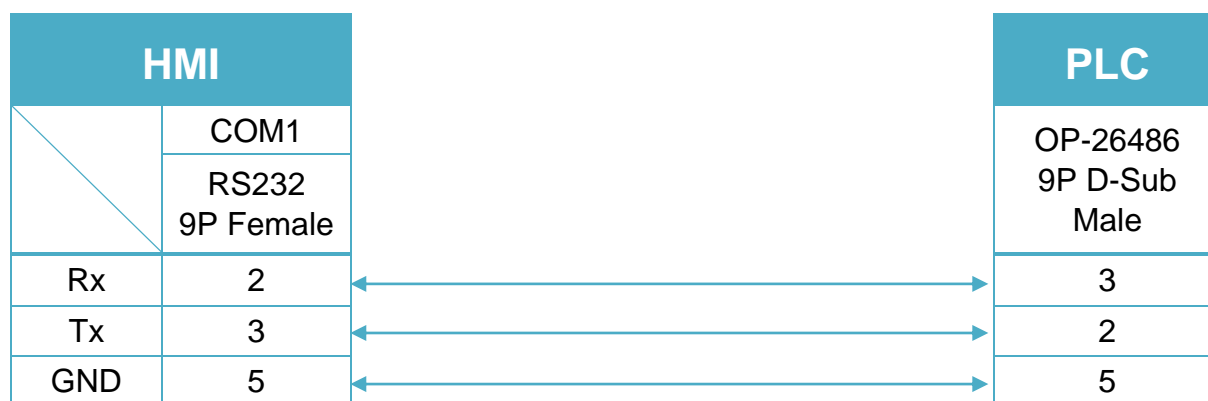
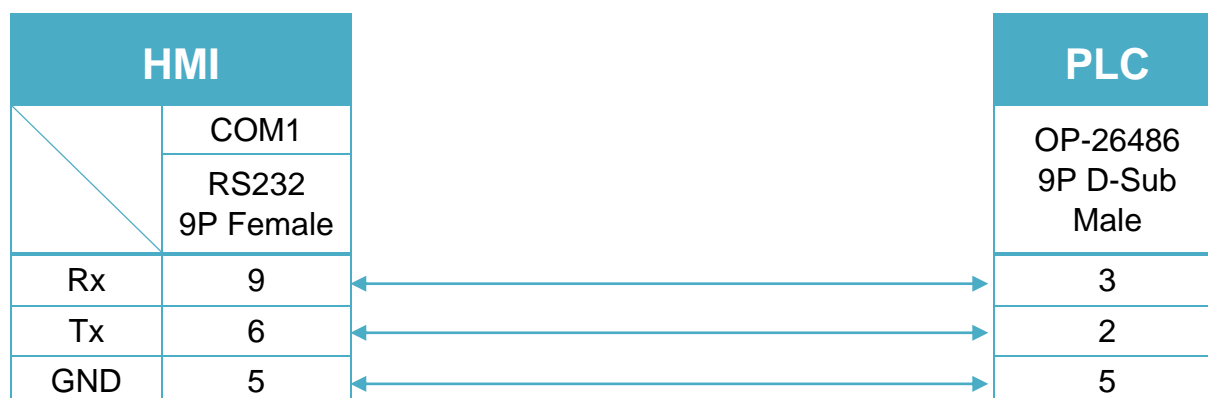


Diagram 3

MT-iE	MT8050iE
MT-iP	MT6051iP / MT6071iP / MT8071iP



9P D-Sub to 6P RJ11 (Diagram 4 ~ Diagram 6)


Diagram 4

cMT Series	<i>cMT3151</i>
eMT Series	<i>eMT3070 / eMT3105 / eMT3120 / eMT3150</i>
MT-iE	<i>MT8073iE / MT8102iE</i>
MT-XE	<i>MT8092XE</i>
MT-iP	<i>MT6103iP</i>

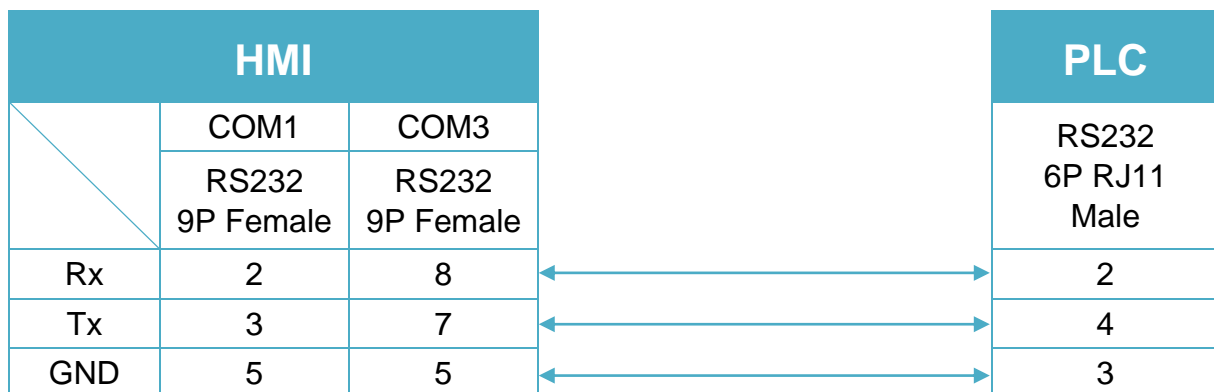


Diagram 5

cMT Series	cMT-SVR
mTV	mTV
MT-iE	MT8070iE / MT6070iE / MT8100iE / MT8121iE / MT8150iE / MT8071iE / MT6071iE / MT8072iE / MT6072iE / MT8073iE / MT8101iE / MT8102iE / MT8103iE
MT-XE	MT8121XE / MT8150XE / MT8090XE

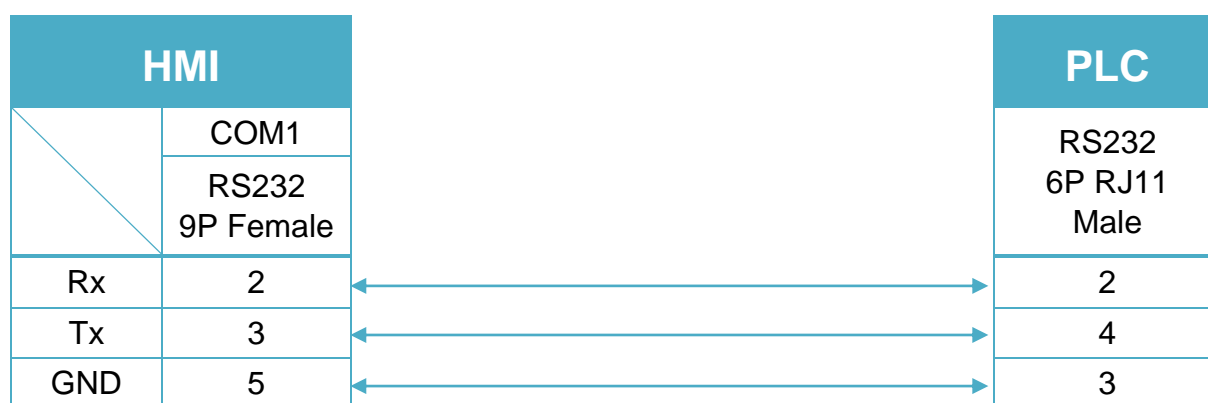
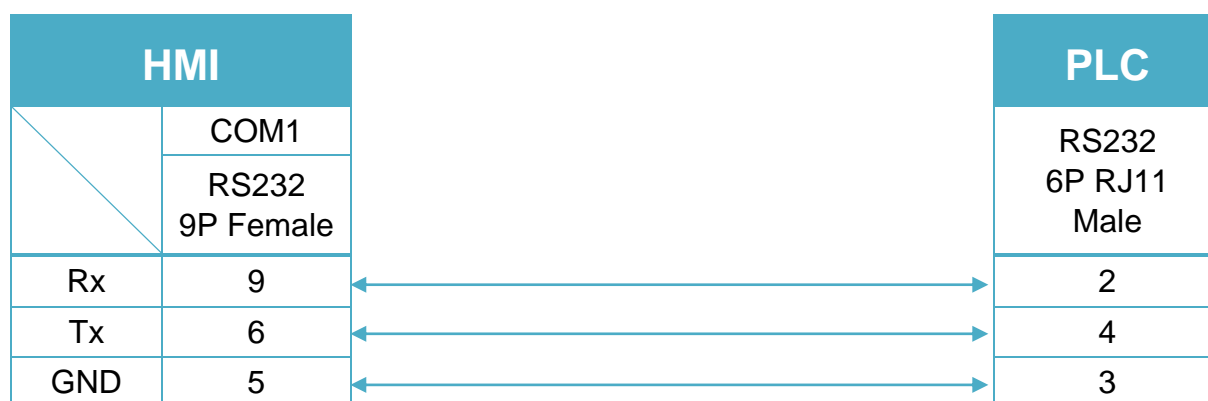


Diagram 6

MT-iE	MT8050iE
MT-iP	MT6051iP / MT6071iP / MT8071iP



KEYENCE KV-3000

Supported Series: KEYENCE KV-3000

Website: <http://www.keyence.com/>

HMI Setting:

Parameters	Recommended	Options	Notes
PLC type	KEYENCE KV-3000		
PLC I/F	RS232		
Baud rate	9600		
Data bits	8		
Parity	Even		
Stop bits	1		
PLC sta. no.	0		

*Support communications between HMI and PLC in pass-through mode

*Set LW-9903 to 2 to enhance the speed of download/upload PLC program in pass-through mode

PLC Setting:

Communication mode	KV STUDIO mode
---------------------------	----------------

Device Address:

Bit/Word	Device type	Format	Range	Memo
B	MR	DDDdd	0 ~ 99915	Intenal auxiliary relay
B	LR	DDDdd	0 ~ 99915	Latch relay
B	CR	DDDdd	0 ~ 99915	Control relay
B	R	DDDdd	0 ~ 99915	Relay
B	B	HHHh	0 ~ 3FFF	Link Relay
B	T	DDDD	0 ~ 9999	Timer
B	C	DDDD	0 ~ 9999	Counter
B	DM_Bit	DDDDDdd	0 ~ 6553515	
B	TM_Bit	DDDDDdd	0 ~ 999915	
B	CM_Bit	DDDDDdd	0 ~ 6553515	
B	EM_Bit	DDDDDdd	0 ~ 6553515	
B	FM_Bit	DDDDDdd	0 ~ 6553515	

Bit/Word	Device type	Format	Range	Memo
W	DM	DDDDD	0 ~ 65535	Data memory
W	TM	DDDD	0 ~ 9999	Temp data momory
W	CM	DDDDD	0 ~ 65535	Control memory
W	EM	DDDDD	0 ~ 65535	Data memory
W	FM	DDDDD	0 ~ 65535	File register
W	MR_Word	DDD	0 ~ 999	
W	LR_Word	DDD	0 ~ 999	
W	CR_Word	DDD	0 ~ 999	
W	W	HHHH	0 ~ 3FFF	Link register
W	ZF	DDDDDD	0 ~ 131071	File register
DW	TC	DDDD	0 ~ 9999	Timer current value
DW	TS	DDDD	0 ~ 9999	Timer set value
DW	CC	DDDD	0 ~ 9999	Counter current value
DW	CS	DDDD	0 ~ 9999	Counter set value
DW	Z	DD	1 ~ 12	
DW	TRM	D	0 ~ 7	

Wiring Diagram:

Diagram 1

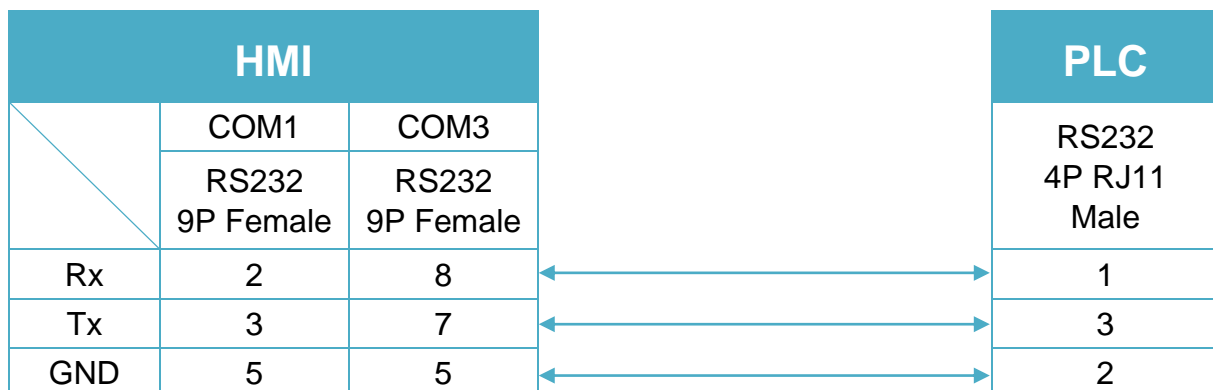
cMT Series
cMT3151
eMT Series
eMT3070 / eMT3105 / eMT3120 / eMT3150
MT-iE
MT8073iE / MT8102iE
MT-XE
MT8092XE
MT-iP
MT6103iP


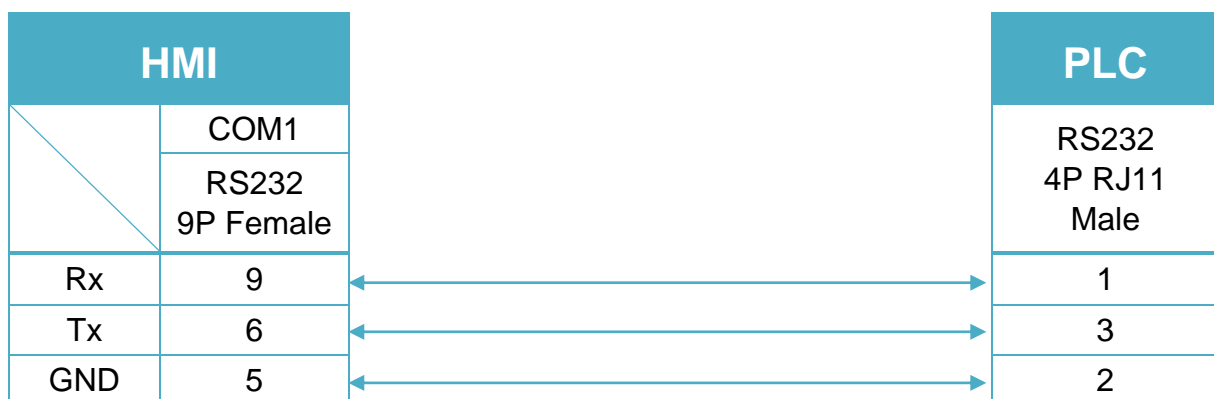
Diagram 2

cMT Series	cMT-SVR
mTV	mTV
MT-iE	MT8070iE / MT6070iE / MT8100iE / MT8121iE / MT8150iE / MT8071iE / MT6071iE / MT8072iE / MT6072iE / MT8073iE / MT8101iE / MT8102iE / MT8103iE
MT-XE	MT8121XE / MT8150XE / MT8090XE



Diagram 3

MT-iE	MT8050iE
MT-iP	MT6051iP / MT6071iP / MT8071iP



KEYENCE KV-L20V/700/1000/3000/5000/Nano

Series

Supported series: KV-L20V,700,1000,3000,5000 series, KV Nano series

Website: <http://www.keyence.com/>

HMI Setting:

Parameters	Recommended	Options	Notes
PLC type	KEYENCE KV-L20V/700/1000/3000/5000/Nano Series		
PLC I/F	RS232	RS232,RS485 2W,RS485 4W	
Baud rate	115200	9600 ~ 115200	
Data bits	8		
Parity	Even		
Stop bits	1		
PLC sta. no.	0		

Online simulator	YES	Extend address mode	NO
-------------------------	-----	----------------------------	----

PLC Setting:

Communication mode	KV mode (host link)
---------------------------	---------------------

Device Address:

Bit/Word	Device type	Format	Range	Memo
B	MR	DDDDdd	0 ~ 399915	Intenal auxiliary relay
B	LR	DDDdd	0 ~ 99915	Latch relay
B	CR	DDDdd	0 ~ 99915	Control relay
B	RLY	DDDdd	0 ~ 99915	Relay
B	B	HHHh	0 ~ 7FFF	Link relay
B	T_Bit	DDDD	0 ~ 9999	Timer
B	C_Bit	DDDD	0 ~ 9999	Counter
B	DM_Bit	DDDDDdd	0 ~ 6553515	Data memory bit
B	TM_Bit	DDDDdd	0 ~ 999915	Temporary data memory bit
B	CM_Bit	DDDDDdd	0 ~ 6553515	Control memory bit
B	EM_Bit	DDDDDdd	0 ~ 6553515	Data memory
B	FM_Bit	DDDDDdd	0 ~ 6553515	File register bit

Bit/Word	Device type	Format	Range	Memo
B	CTC_Bit	D	0 ~ 7	
B	ZF_Bit	DDDDDDdd	0 ~ 52428715	File register (SQ)
B	W_Bit	HHHHh	0 ~ 7FFFF	Link register bit
B	W_Bit_Dec	HHHHdd	0 ~ 7FFF15	
B	VM_Bit	DDDDDDdd	0 ~ 6553515	
B	VB_Bit	HHHHh	0 ~ F9FF	
W	DM	DDDDD	0 ~ 65535	Data memory
W	TM	DDDD	0 ~ 9999	Temporary data memory
W	W	HHHH	0 ~ 7FFF	Link register
W	VM	DDDDD	0 ~ 65535	
W	CM	DDDDD	0 ~ 65535	Control memory
W	EM	DDDDD	0 ~ 65535	Data memory
W	FM	DDDDD	0 ~ 65535	File register
W	MR_Word	DDDD	0 ~ 3999	Intenal auxiliary relay
W	LR_Word	DDD	0 ~ 999	Latch relay
W	CR_Word	DDD	0 ~ 999	Control relay
W	ZF	DDDDDD	0 ~ 524287	File register (SQ)
W	VB	HHH	0 ~ F9F	
W	RLY_Word	DDD	0 ~ 999	Relay
W	B_Word	HHH	0 ~ 7FF	Link relay
W	T	DDDD	0 ~ 9999	Timer
W	C	DDDD	0 ~ 9999	Counter
W	T_Curr	DDDD	0 ~ 9999	Timer current
W	T_Preset	DDDD	0 ~ 9999	Timer preset
W	C_Curr	DDDD	0 ~ 9999	Counter current
W	C_Preset	DDDD	0 ~ 9999	Counter preset
W	TRM	D	0 ~ 7	
W	Z	DD	1 ~ 12	
W	CTH	D	0 ~ 3	
W	CTC	D	0 ~ 7	

Wiring Diagram:

OP-26486 RS232 (Diagram 1 ~ Diagram 3)

Diagram 1

cMT Series	<i>cMT3151</i>
eMT Series	<i>eMT3070 / eMT3105 / eMT3120 / eMT3150</i>
MT-iE	<i>MT8073iE / MT8102iE</i>
MT-XE	<i>MT8092XE</i>
MT-iP	<i>MT6103iP</i>

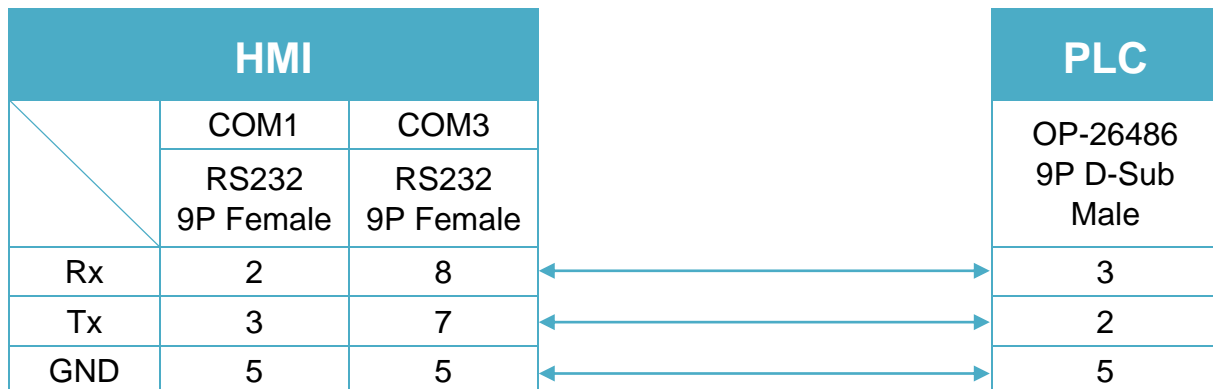


Diagram 2

cMT Series	cMT-SVR
mTV	mTV
MT-iE	MT8070iE / MT6070iE / MT8100iE / MT8121iE / MT8150iE / MT8071iE / MT6071iE / MT8072iE / MT6072iE / MT8073iE / MT8101iE / MT8102iE / MT8103iE
MT-XE	MT8121XE / MT8150XE / MT8090XE

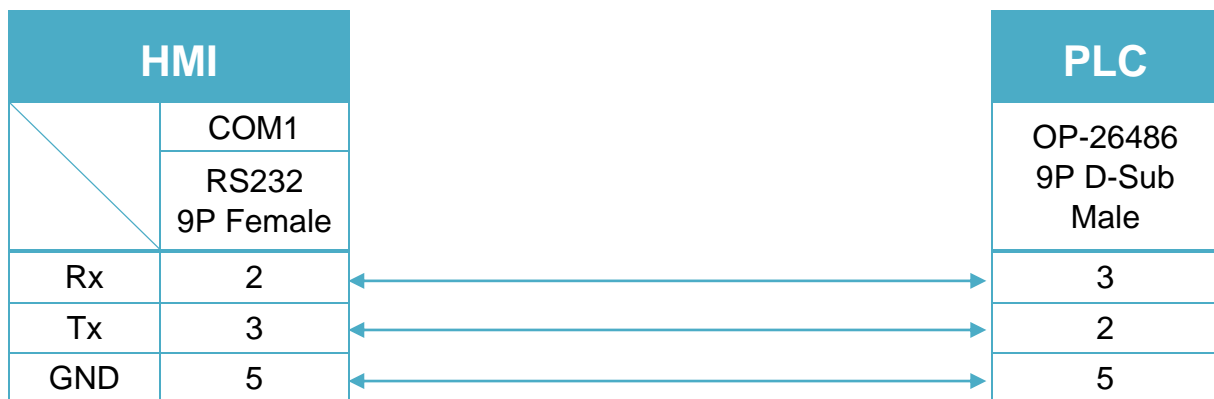
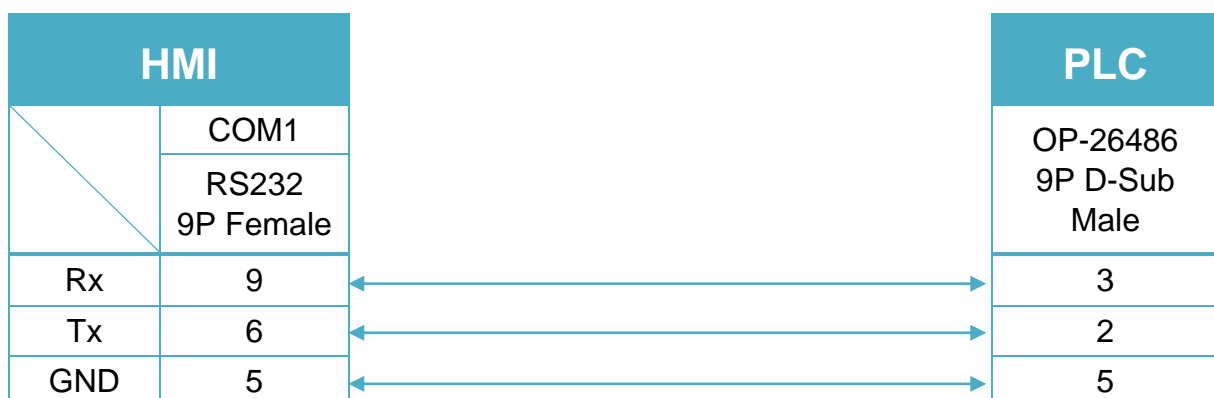


Diagram 3

MT-iE	MT8050iE
MT-iP	MT6051iP / MT6071iP / MT8071iP



KV-L20V Port2 RS232 terminal (Diagram 4 ~ Diagram 6)

Diagram 4

cMT Series	<i>cMT3151</i>
eMT Series	<i>eMT3070 / eMT3105 / eMT3120 / eMT3150</i>
MT-iE	<i>MT8073iE / MT8102iE</i>
MT-XE	<i>MT8092XE</i>
MT-iP	<i>MT6103iP</i>



Diagram 5

cMT Series	<i>cMT-SVR</i>
mTV	<i>mTV</i>
MT-iE	<i>MT8070iE / MT6070iE / MT8100iE / MT8121iE / MT8150iE / MT8071iE / MT6071iE / MT8072iE / MT6072iE / MT8073iE / MT8101iE / MT8102iE / MT8103iE</i>
MT-XE	<i>MT8121XE / MT8150XE / MT8090XE</i>

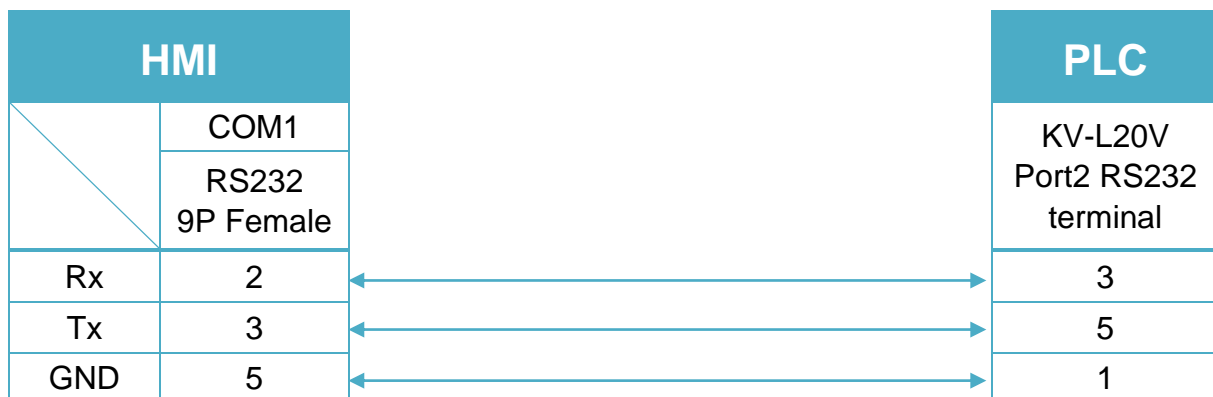
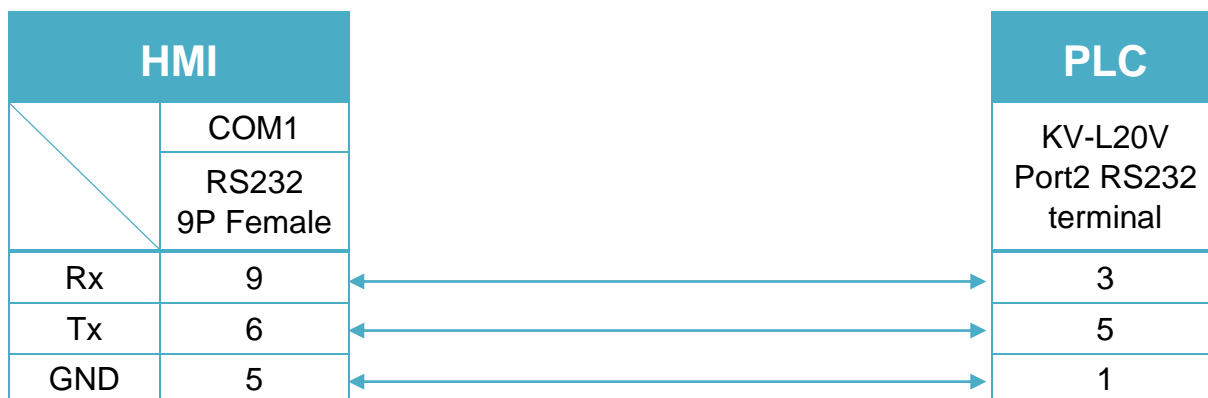


Diagram 6

MT-iE
MT8050iE
MT-iP
MT6051iP / MT6071iP / MT8071iP


KV-L20V Port2 RS485 2W terminal (Diagram 7 ~ Diagram 12)

Diagram 7

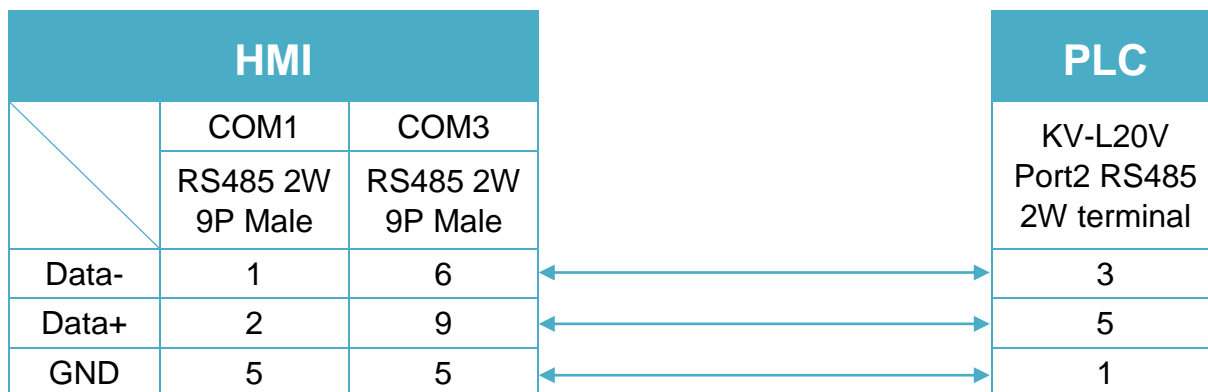
cMT Series
cMT3151
eMT Series
eMT3070/ eMT3105 / eMT3120 / eMT3150


Diagram 8

cMT Series *cMT-SVR*

mTV *mTV*

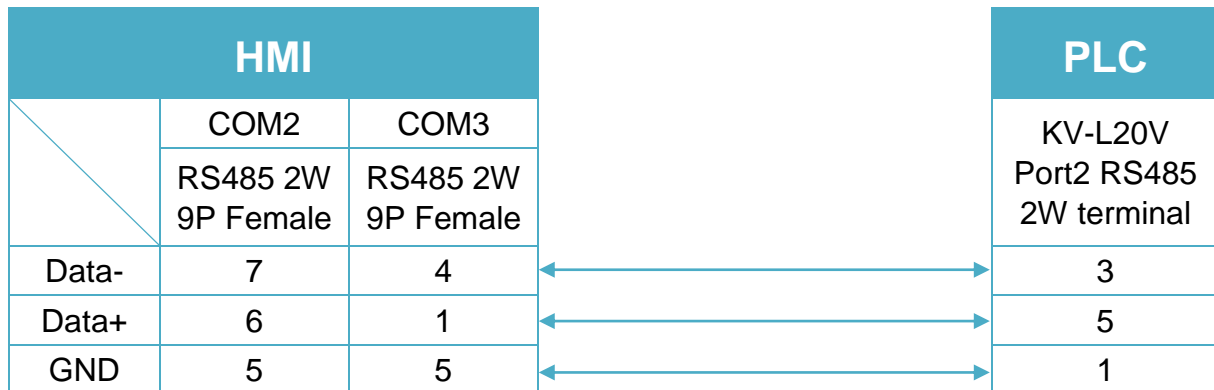


Diagram 9

MT-iE *MT8070iE / MT6070iE / MT8100iE / MT8121iE / MT8150iE*

MT-XE *MT8121XE / MT8150XE*

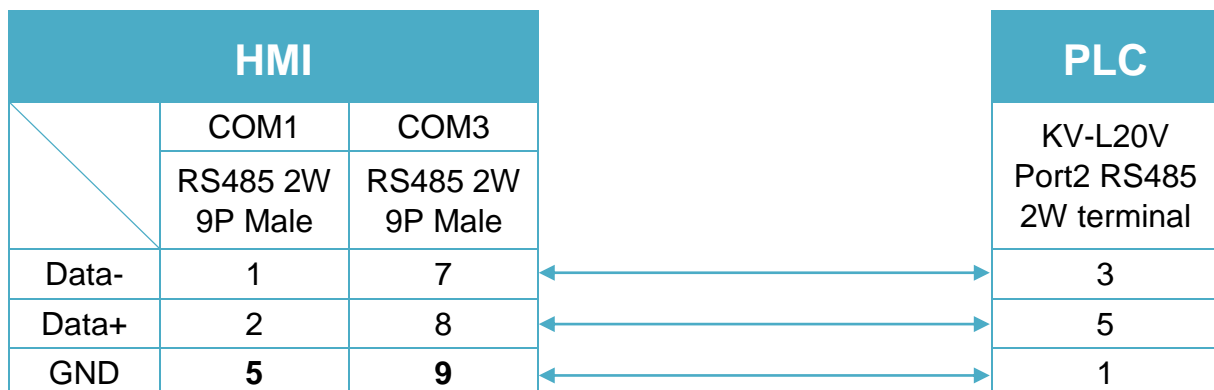


Diagram 10

MT-iE	<i>MT8071iE / MT6071iE / MT8072iE / MT6072iE / MT8073iE / MT8101iE / MT8102iE / MT8103iE</i>
MT-XE	<i>MT8090XE / MT8092XE</i>
MT-iP	<i>MT6103iP</i>

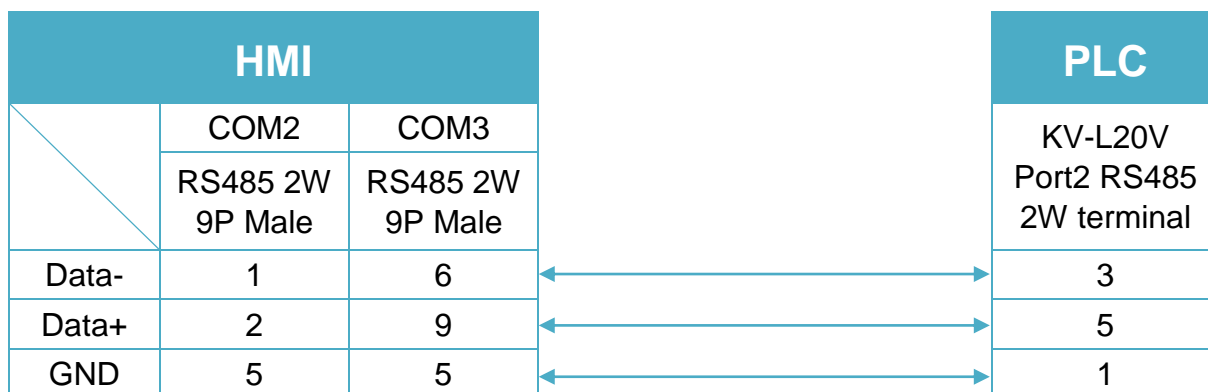


Diagram 11

MT-iE	<i>MT8050iE</i>
MT-iP	<i>MT6051iP</i>

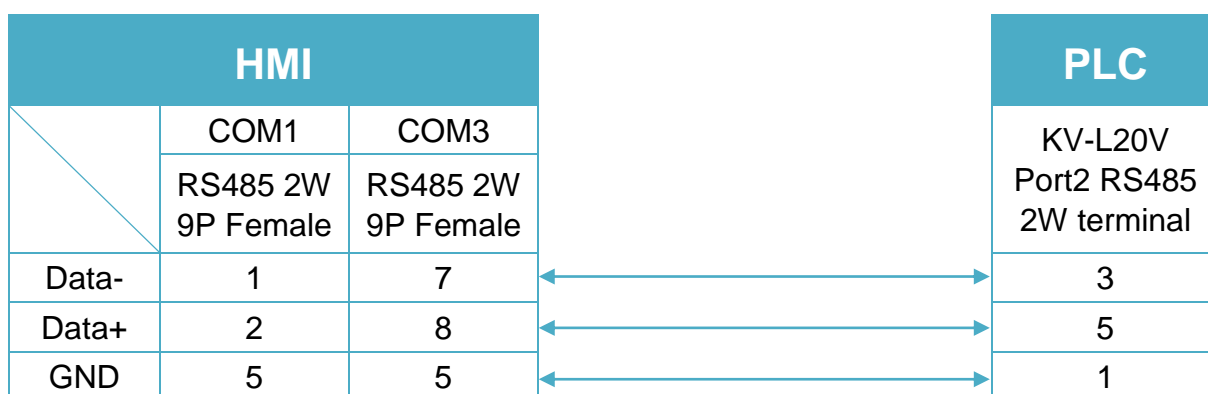
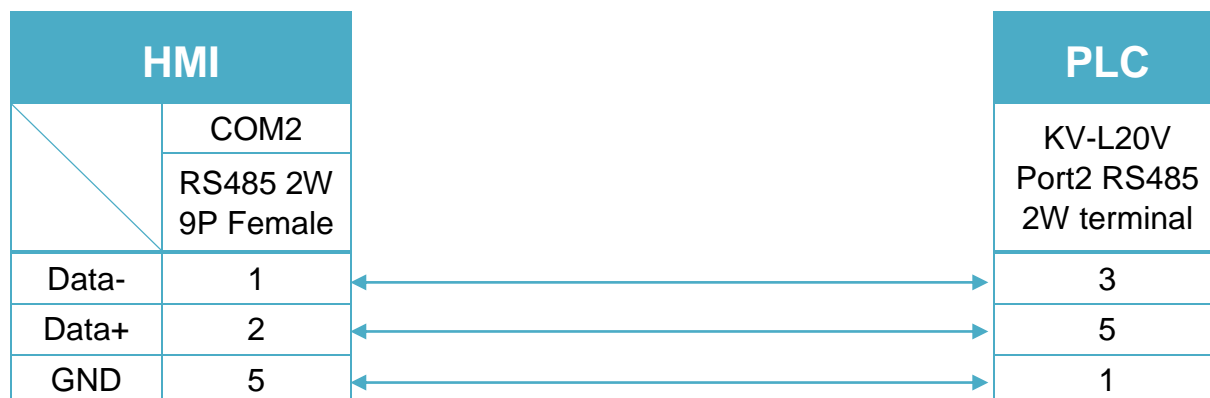


Diagram 12

MT-iP *MT6071iP / MT8071iP*



KV-L20V Port2 RS485 4W terminal (Diagram 13 ~ Diagram 16)

Diagram 13

cMT Series *cMT3151*

eMT Series *eMT3070/ eMT3105 / eMT3120 / eMT3150*

MT-iE *MT8070iE / MT6070iE / MT8100iE / MT8121iE / MT8150iE*

MT-XE *MT8121XE / MT8150XE*

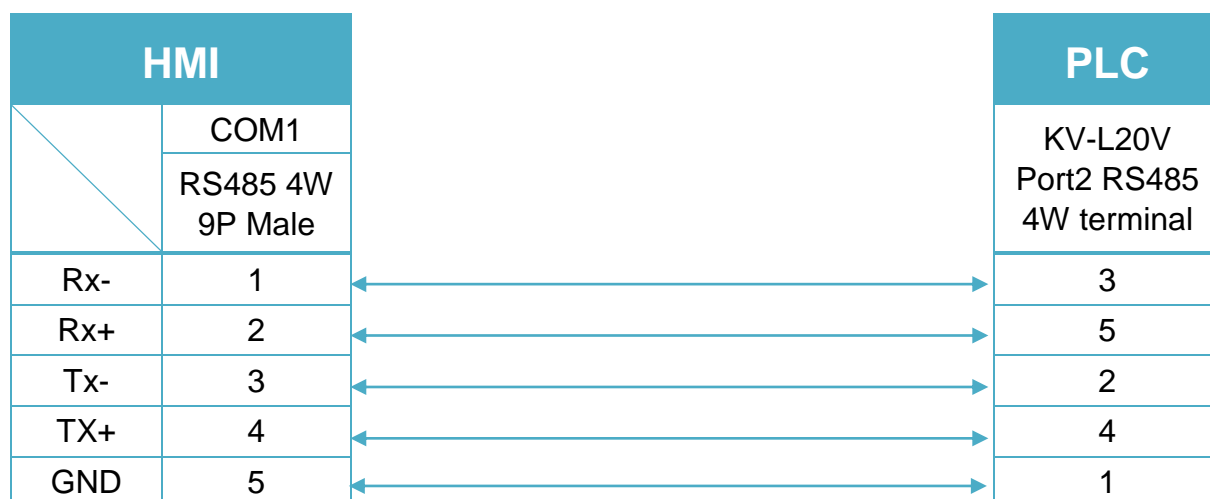


Diagram 14

cMT Series *cMT-SVR*

mTV *mTV*

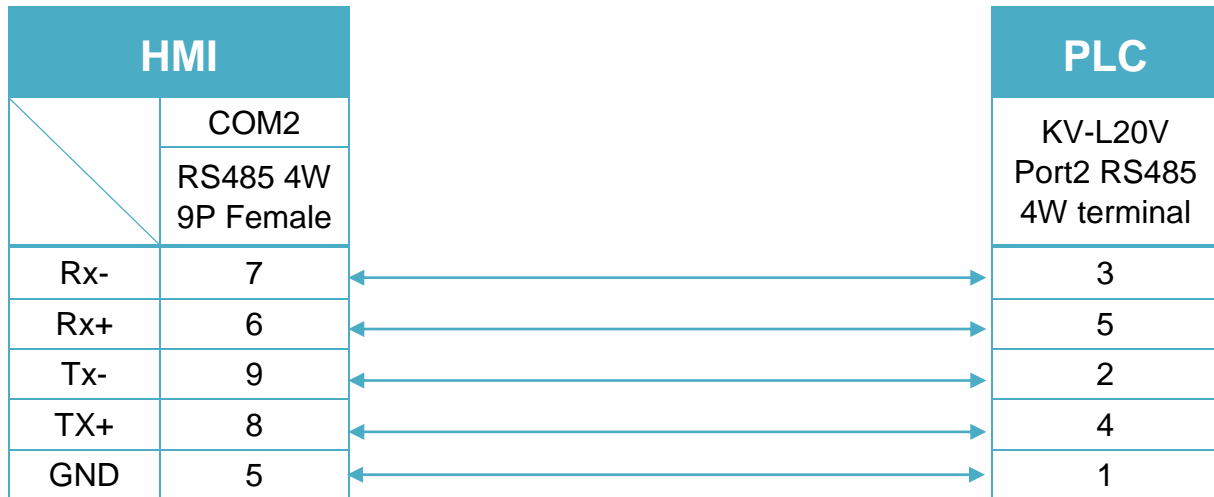


Diagram 15

MT-iE *MT8071iE / MT6071iE / MT8072iE / MT6072iE / MT8073iE /
MT8101iE / MT8102iE / MT8103iE*

MT-XE *MT8090XE / MT8092XE*

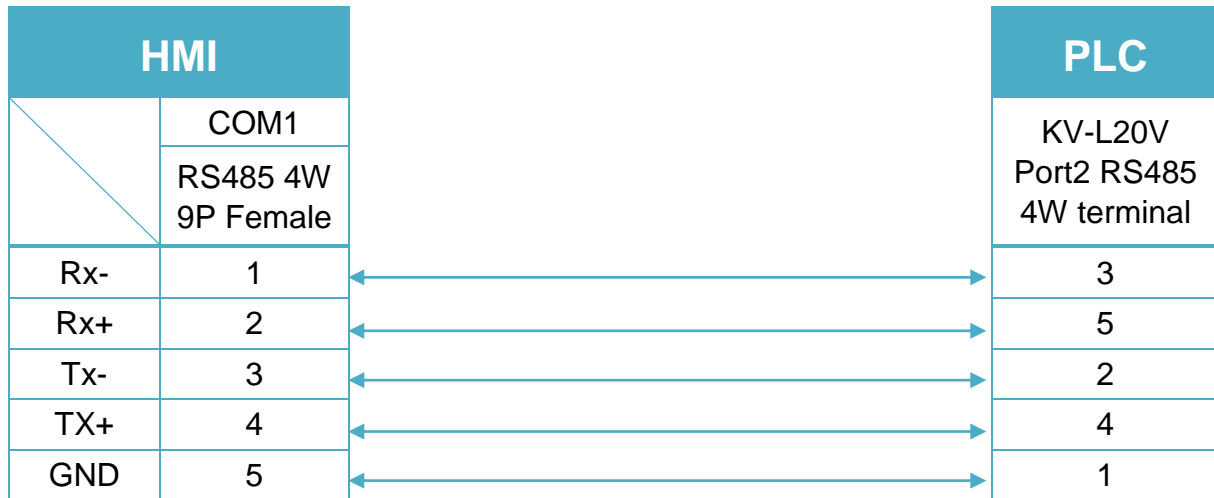
MT-iP *MT6071iP / MT8071iP / MT6103iP*



Diagram 16

MT-iE *MT8050iE*

MT-iP *MT6051iP*



KEYENCE

KV-L20V/700/1000/3000/5000/7500/Nano Series

(Ethernet)

Supported series: KV-L20V,700,1000,3000,5000 series, KV Nano series

Website: <http://www.keyence.com/>

HMI Setting:

Parameters	Recommended	Options	Notes
PLC type	KEYENCE KV-L20V/700/1000/3000/5000/7500/Nano		
PLC I/F	Ethernet		
Port no.	8501		
PLC sta. no.	0		

Device Address:

Bit/Word	Device type	Format	Range	Memo
B	MR	DDDDdd	0 ~ 399915	Intenal auxiliary relay
B	LR	DDDdd	0 ~ 99915	Latch relay
B	CR	DDDdd	0 ~ 99915	Control relay
B	RLY	DDDdd	0 ~ 99915	Relay
B	B	HHHh	0 ~ 7FFF	Link relay
B	T_Bit	DDDD	0 ~ 9999	Timer
B	C_Bit	DDDD	0 ~ 9999	Counter
B	DM_Bit	DDDDDdd	0 ~ 6553515	Data memory bit
B	TM_Bit	DDDDdd	0 ~ 999915	Temporary data memory bit
B	CM_Bit	DDDDDdd	0 ~ 6553515	Control memory bit
B	EM_Bit	DDDDDdd	0 ~ 6553515	Data memory
B	FM_Bit	DDDDDdd	0 ~ 6553515	File register bit
B	CTC_Bit	D	0 ~ 7	
B	ZF_Bit	DDDDDDdd	0 ~ 52428715	File register (SQ)
B	W_Bit	HHHHh	0 ~ 7FFFF	Link register bit
B	W_Bit_Dec	HHHHdd	0 ~ 7FFF15	
B	VM_Bit	DDDDDdd	0 ~ 6553515	
B	VB_Bit	HHHHh	0 ~ F9FF	
'W	DM	DDDDD	0 ~ 65535	Data memory

Bit/Word	Device type	Format	Range	Memo
W	TM	DDDD	0 ~ 9999	Temporary data memory
W	W	HHHH	0 ~ 7FFF	Link register
W	VM	DDDDD	0 ~ 65535	
W	CM	DDDDD	0 ~ 65535	Control memory
W	EM	DDDDD	0 ~ 65535	Data memory
W	FM	DDDDD	0 ~ 65535	File register
W	MR_Word	DDDD	0 ~ 3999	Intenal auxiliary relay
W	LR_Word	DDD	0 ~ 999	Latch relay
W	CR_Word	DDD	0 ~ 999	Control relay
W	ZF	DDDDDD	0 ~ 524287	File register (SQ)
W	VB	HHH	0 ~ F9F	
W	RLY_Word	DDD	0 ~ 999	Relay
W	B_Word	HHH	0 ~ 7FF	Link relay
W	T	DDDD	0 ~ 9999	Timer
W	C	DDDD	0 ~ 9999	Counter
W	T_Curr	DDDD	0 ~ 9999	Timer current
W	T_Preset	DDDD	0 ~ 9999	Timer preset
W	C_Curr	DDDD	0 ~ 9999	Counter current
W	C_Preset	DDDD	0 ~ 9999	Counter preset
W	TRM	D	0 ~ 7	
W	Z	DD	1 ~ 12	
W	CTH	D	0 ~ 3	
W	CTC	D	0 ~ 7	

Wiring Diagram:

Diagram 1

Ethernet cable:



KEYENCE KV-L20V/700/1000/3000/5000/Nano Series (KV Studio Mode)

Supported series: KV-L20V,700,1000,3000,5000 series, KV Nano series

Website: <http://www.keyence.com/>

HMI Setting:

Parameters	Recommended	Options	Notes
PLC type	KEYENCE KV-L20V/700/1000/3000/5000/Nano Series (KV Studio Mode)		
PLC I/F	RS232	RS232,RS485 2W,RS485 4W	
Baud rate	115200	9600 ~ 115200	
Data bits	8		
Parity	Even		
Stop bits	1		
PLC sta. no.	0		

Online simulator	YES	Extend address mode	NO
-------------------------	-----	----------------------------	----

PLC Setting:

Communication mode	KV STUDIO mode
---------------------------	----------------

Device Address:

Bit/Word	Device type	Format	Range	Memo
B	MR	DDDdd	0 ~ 99915	
B	LR	DDDdd	0 ~ 99915	
B	CR	DDDdd	0 ~ 99915	
B	R	DDDdd	0 ~ 99915	
B	B	HHHh	0 ~ 3FFF	
B	T	DDDD	0 ~ 9999	
B	C	DDDD	0 ~ 9999	
B	DM_Bit	DDDDDdd	0 ~ 6553515	
B	TM_Bit	DDDDdd	0 ~ 999915	
B	CM_Bit	DDDDDdd	0 ~ 6553515	
B	CTC_Bit	Ddd	0 ~ 315	

Bit/Word	Device type	Format	Range	Memo
B	W_Bit	HHHHh	0 ~ 3FFFF	
B	VM_Bit	DDDDdd	0 ~ 6553515	
B	VB_Bit	HHHh	0 ~ 3FFF	
W	DM	DDDDD	0 ~ 65535	
W	TM	DDDD	0 ~ 9999	
W	CM	DDDDD	0 ~ 65535	
W	EM	DDDDD	0 ~ 65535	
W	FM	DDDDD	0 ~ 65535	
W	MR_Word	DDD	0 ~ 999	
W	LR_Word	DDD	0 ~ 999	
W	CR_Word	DDD	0 ~ 999	
W	W	HHHH	0 ~ 3FFF	
W	VM	DDDDD	0 ~ 65535	
W	VB	HHH	0 ~ 3FFF	
W	R_Word	DDD	0 ~ 999	
W	B_Word	HHH	0 ~ 3FF	
W	TC	DDDD	0 ~ 9999	
W	TS	DDDD	0 ~ 9999	
W	CC	DDDD	0 ~ 9999	
W	CS	DDDD	0 ~ 9999	
DW	CTH	D	0 ~ 1	
DW	CTC	D	0 ~ 3	
DW	Z_DWORD	DD	1 ~ 12	

Wiring Diagram:

OP-26486 9P RS232 (Diagram 1 ~ Diagram 3)

Diagram 1

cMT Series	<i>cMT3151</i>
eMT Series	<i>eMT3070 / eMT3105 / eMT3120 / eMT3150</i>
MT-iE	<i>MT8073iE / MT8102iE</i>
MT-XE	<i>MT8092XE</i>
MT-iP	<i>MT6103iP</i>

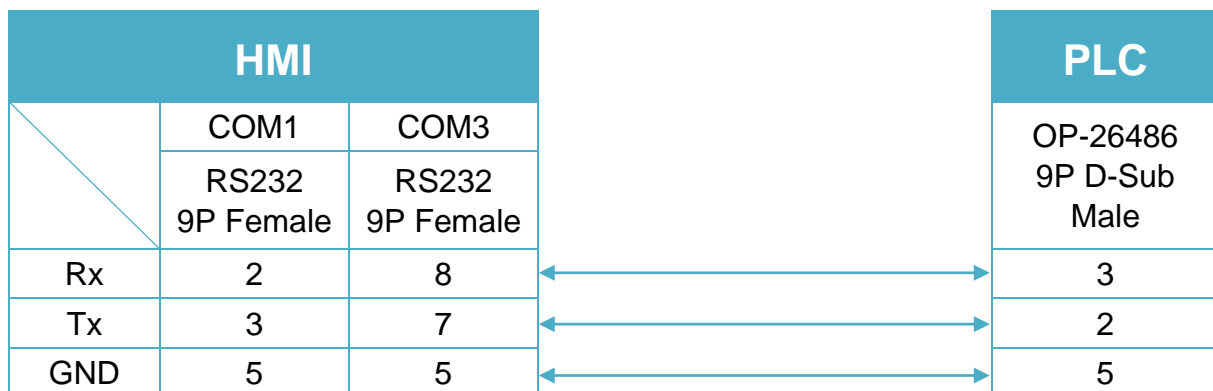


Diagram 2

cMT Series	<i>cMT-SVR</i>
mTV	<i>mTV</i>
MT-iE	<i>MT8070iE / MT6070iE / MT8100iE / MT8121iE / MT8150iE / MT8071iE / MT6071iE / MT8072iE / MT6072iE / MT8073iE / MT8101iE / MT8102iE / MT8103iE</i>
MT-XE	<i>MT8121XE / MT8150XE / MT8090XE</i>

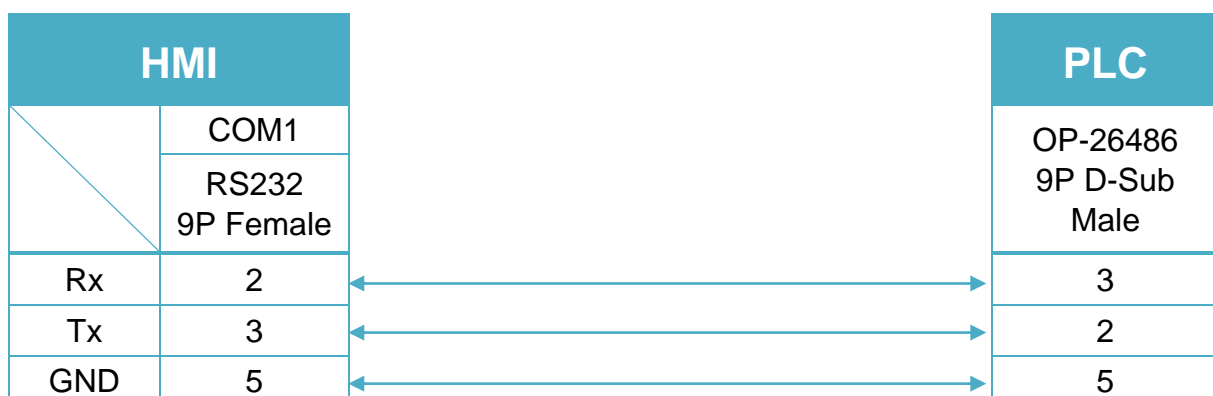


Diagram 3

MT-iE	MT8050iE
MT-iP	MT6051iP / MT6071iP / MT8071iP



KV-L20V Port2 RS232 terminal (Diagram 4 ~ Diagram 6)

Diagram 4

cMT Series	cMT3151
eMT Series	eMT3070/ eMT3105 / eMT3120 / eMT3150
MT-iE	MT8073iE / MT8102iE
MT-XE	MT8092XE
MT-iP	MT6103iP

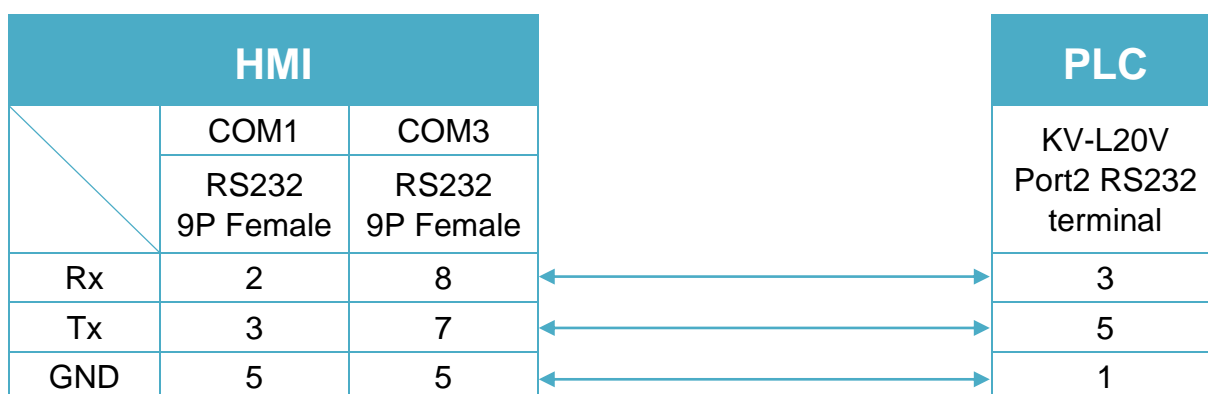


Diagram 5

cMT Series	cMT-SVR
mTV	mTV
MT-iE	MT8070iE / MT6070iE / MT8100iE / MT8121iE / MT8150iE / MT8071iE / MT6071iE / MT8072iE / MT6072iE / MT8073iE / MT8101iE / MT8102iE / MT8103iE
MT-XE	MT8121XE / MT8150XE / MT8090XE

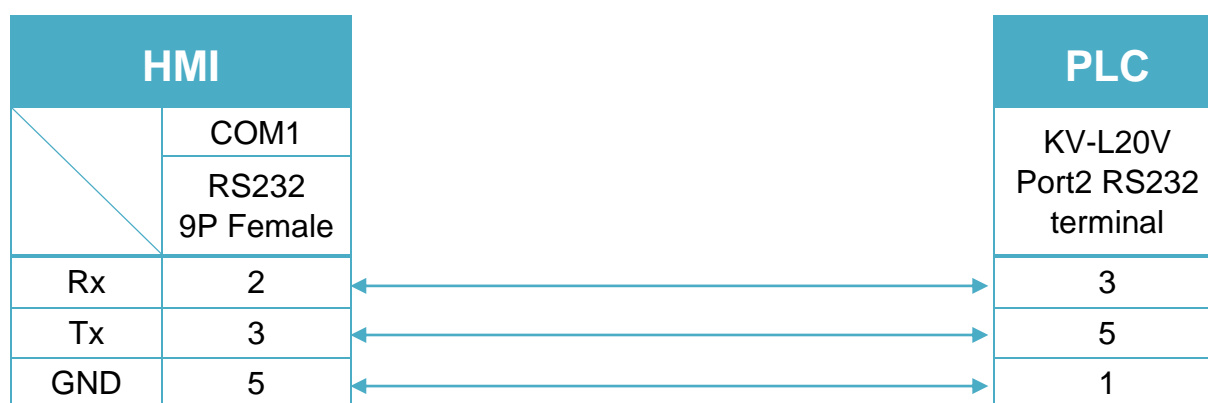
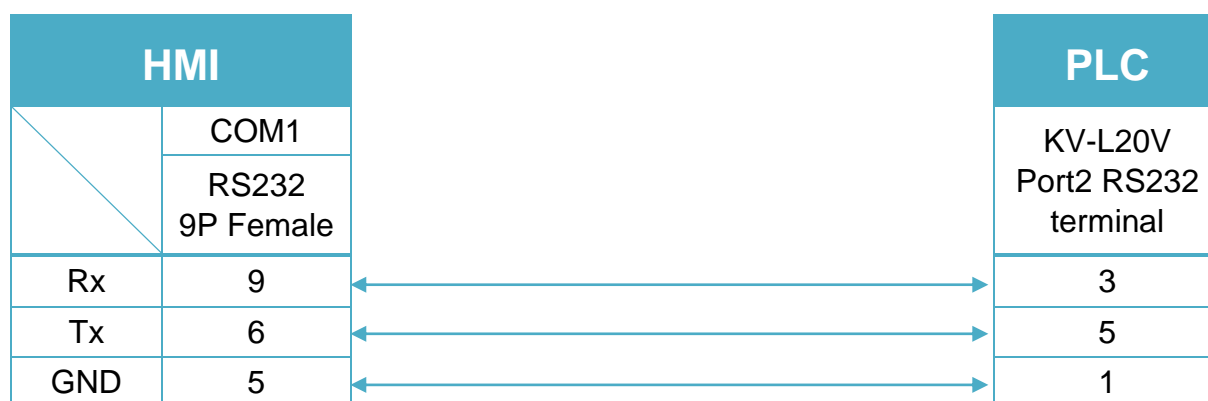


Diagram 6

MT-iE	MT8050iE
MT-iP	MT6051iP / MT6071iP / MT8071iP



KV-L20V Port2 RS485 2W (Diagram 7 ~ Diagram 12)

Diagram 7

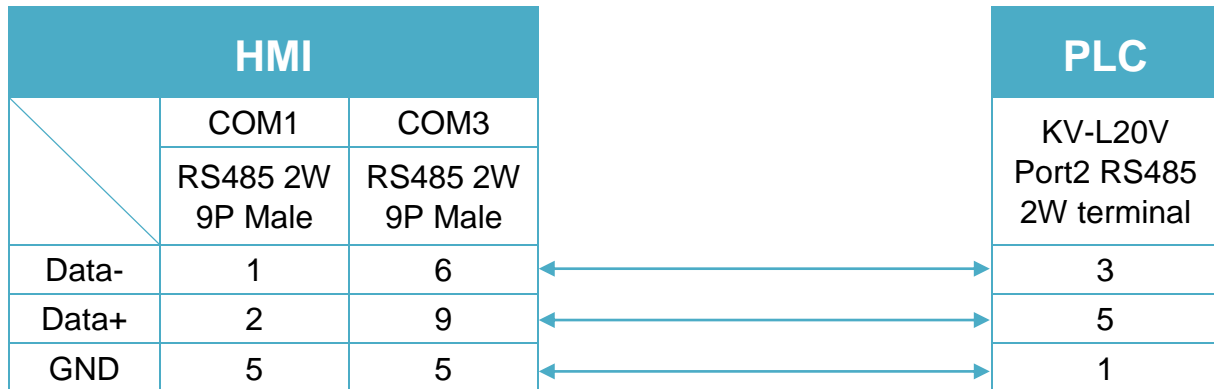
cMT Series
cMT3151
eMT Series
eMT3070 / eMT3105 / eMT3120 / eMT3150


Diagram 8

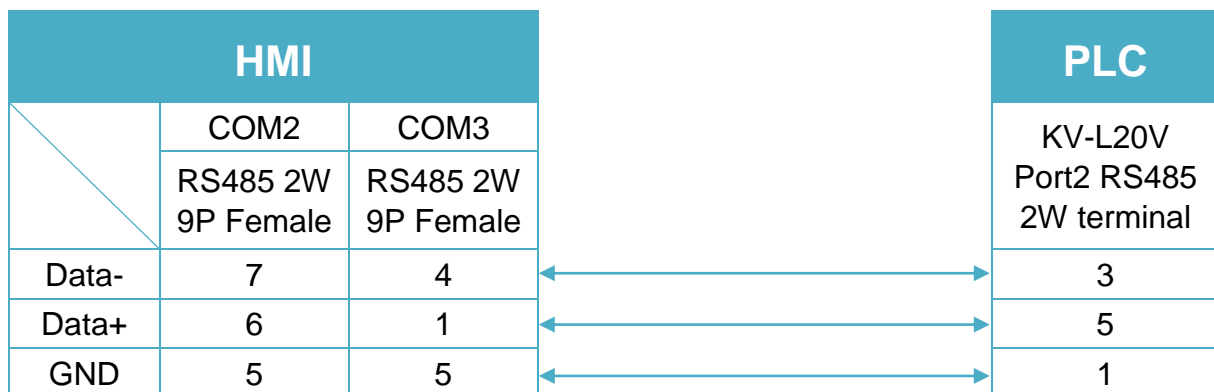
cMT Series
cMT-SVR
mTV
mTV


Diagram 9

MT-iE *MT8070iE / MT6070iE / MT8100iE / MT8121iE / MT8150iE*

MT-XE *MT8121XE / MT8150XE*

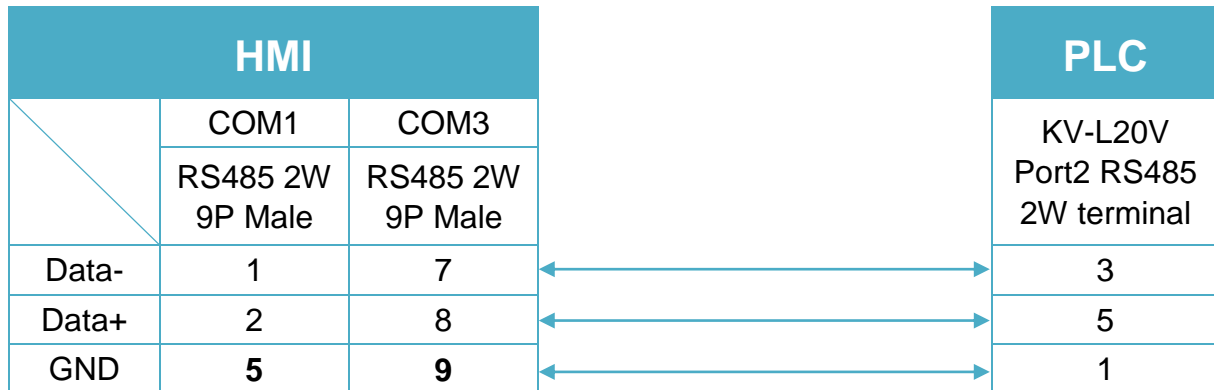


Diagram 10

MT-iE *MT8071iE / MT6071iE / MT8072iE / MT6072iE / MT8073iE /
MT8101iE / MT8102iE / MT8103iE*

MT-XE *MT8090XE / MT8092XE*

MT-iP *MT6103iP*

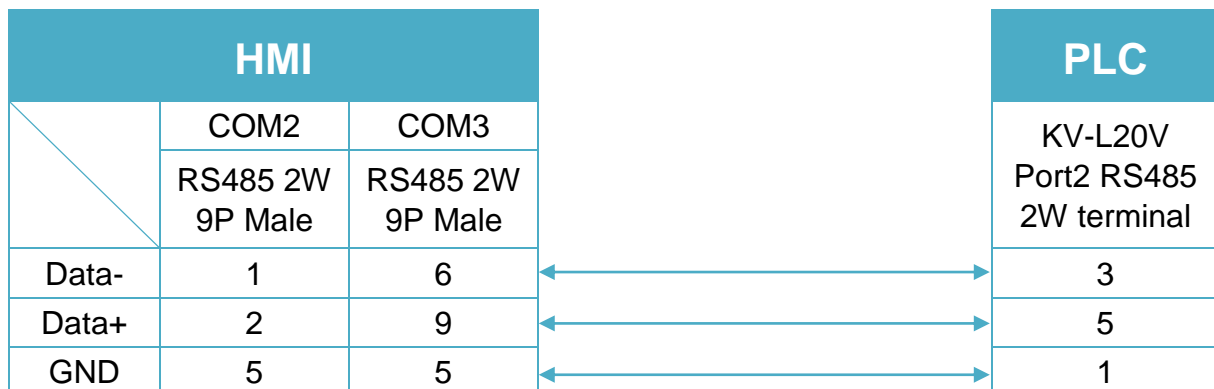


Diagram 11

MT-iE *MT8050iE*

MT-iP *MT6051iP*

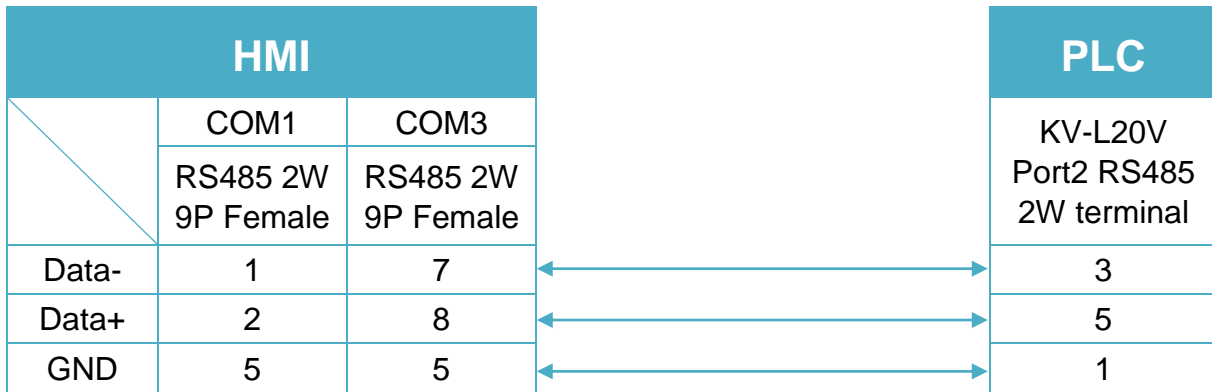
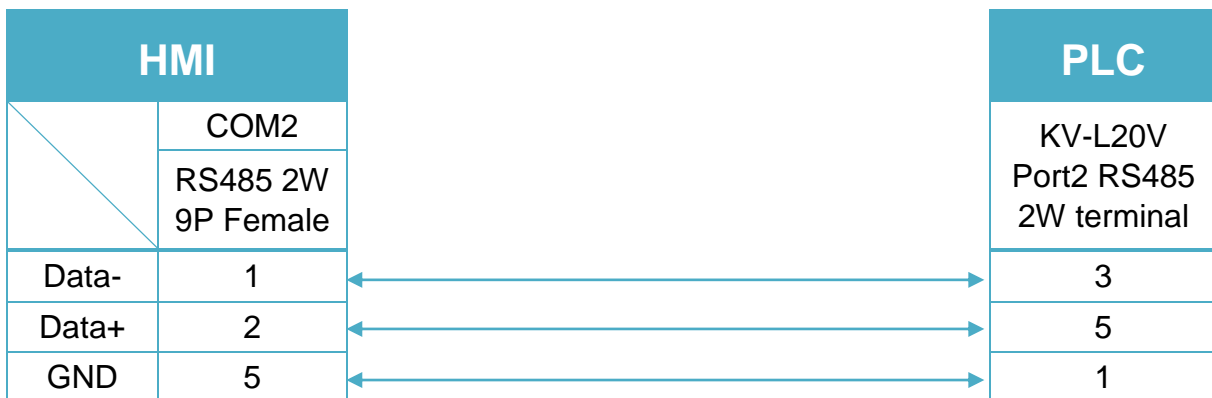


Diagram 12

MT-iP *MT6071iP / MT8071iP*



KV-L20V Port2 RS485 4W (Diagram 13 ~ Diagram 16)

Diagram 13

cMT Series	<i>cMT3151</i>
eMT Series	<i>eMT3070 / eMT3105 / eMT3120 / eMT3150</i>
MT-iE	<i>MT8070iE / MT6070iE / MT8100iE / MT8121iE / MT8150iE</i>
MT-XE	<i>MT8121XE / MT8150XE</i>

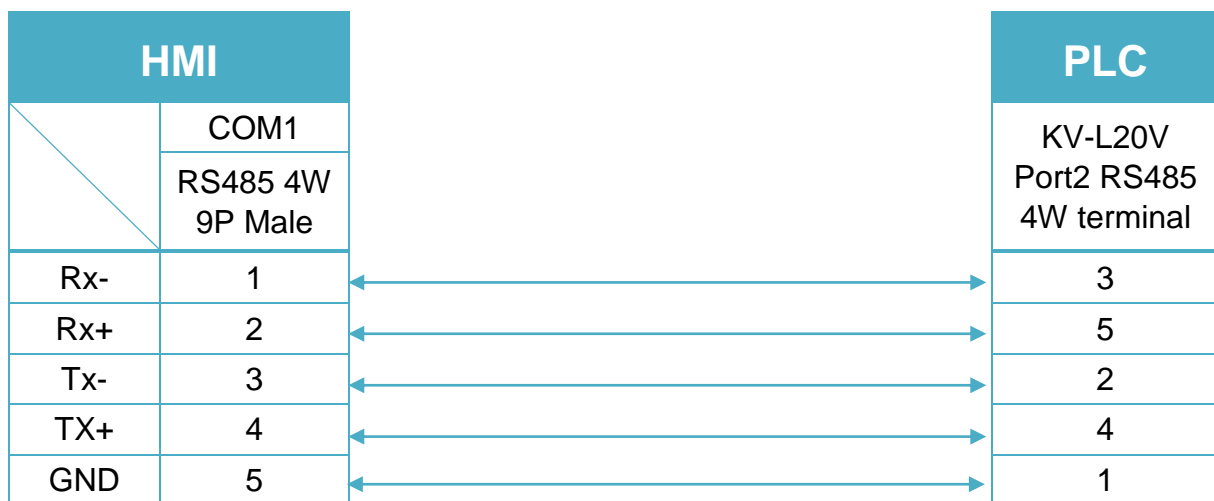


Diagram 14

cMT Series	<i>cMT-SVR</i>
mTV	<i>mTV</i>

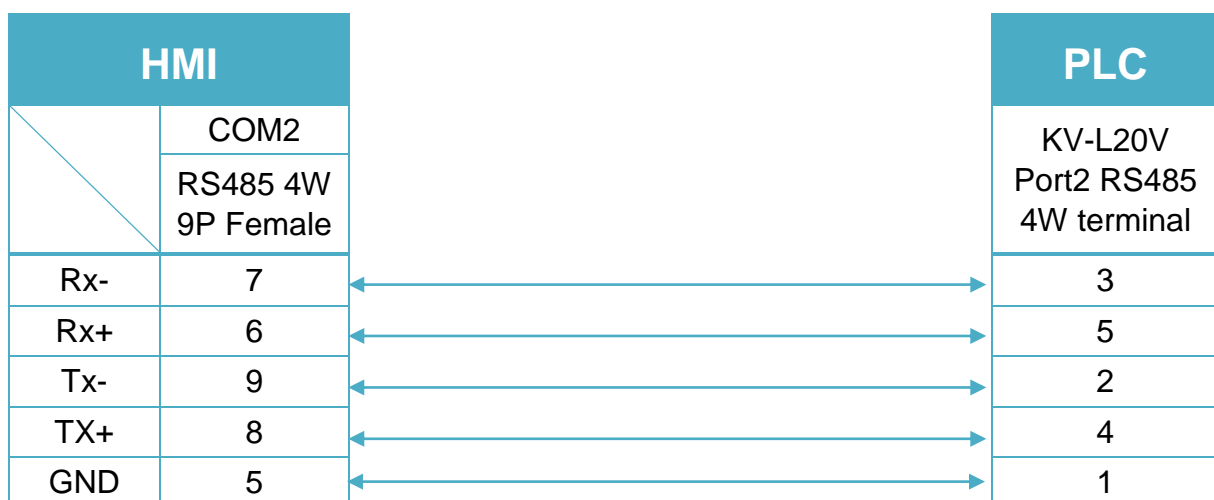


Diagram 15

MT-iE	<i>MT8071iE / MT6071iE / MT8072iE / MT6072iE / MT8073iE / MT8101iE / MT8102iE / MT8103iE</i>
MT-XE	<i>MT8090XE / MT8092XE</i>
MT-iP	<i>MT6071iP / MT8071iP / MT6103iP</i>

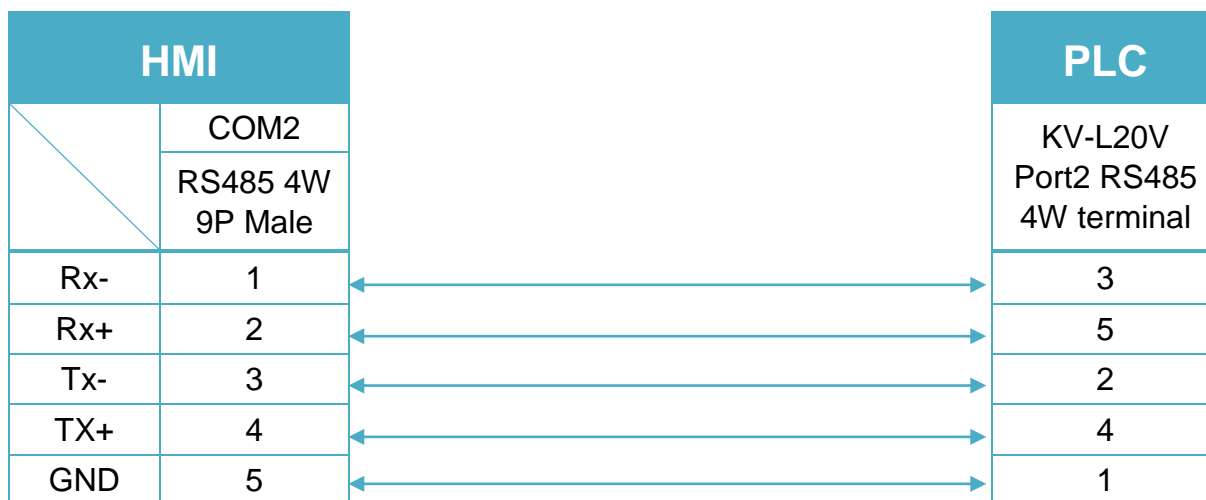
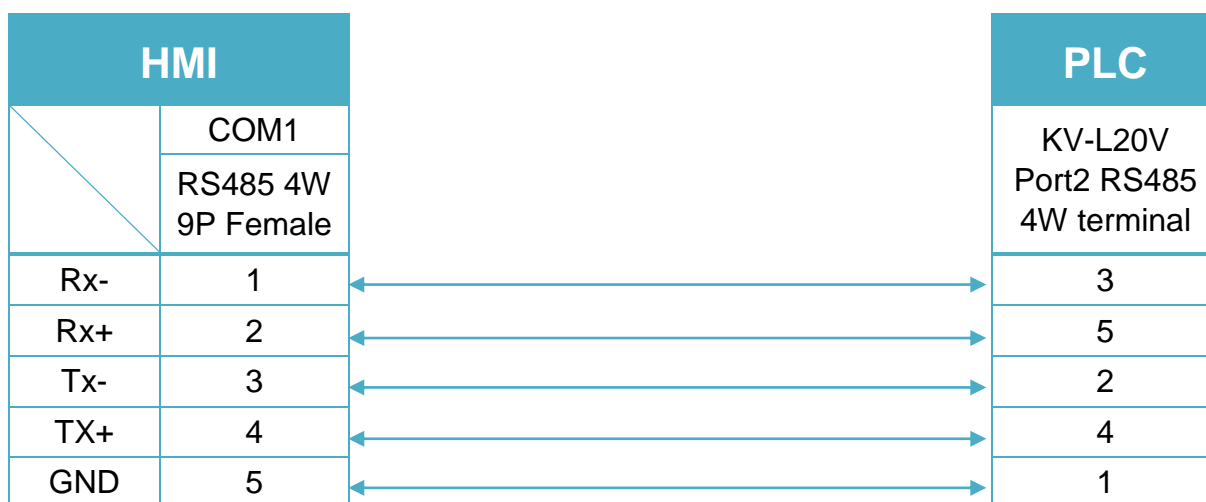


Diagram 16

MT-iE	<i>MT8050iE</i>
MT-iP	<i>MT6051iP</i>



KONNEX KNXnet/IP

Supported series: WAGO 750-849

HMI Setting:

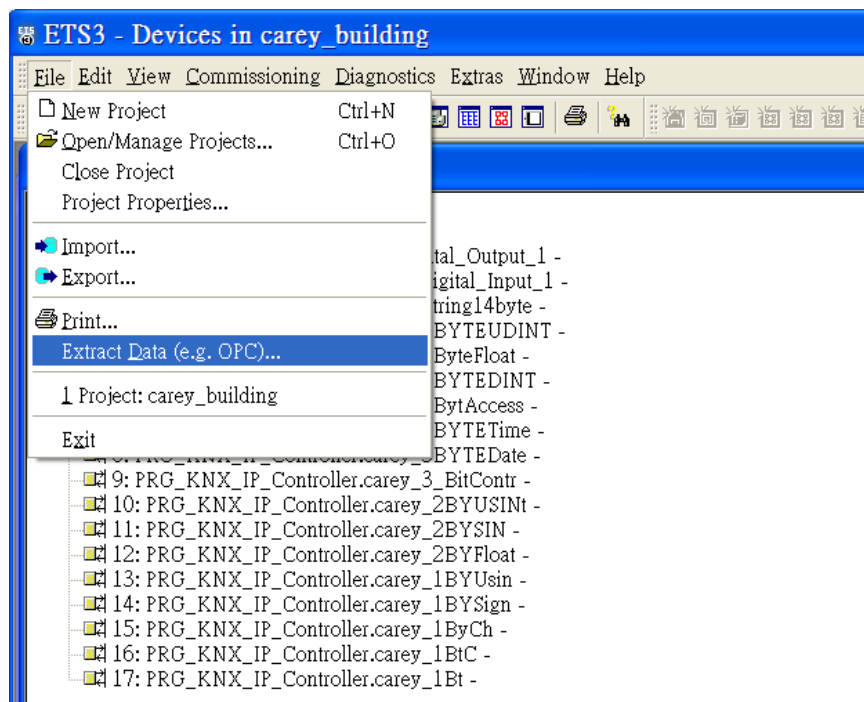
Parameters	Recommended	Options	Notes
PLC type	KONNEX KNXnet/IP		
PLC I/F	Ethernet		USE UDP
Multi. Cast IP address	224.0.23.12		
Port no.	3671		

Support Device Type:

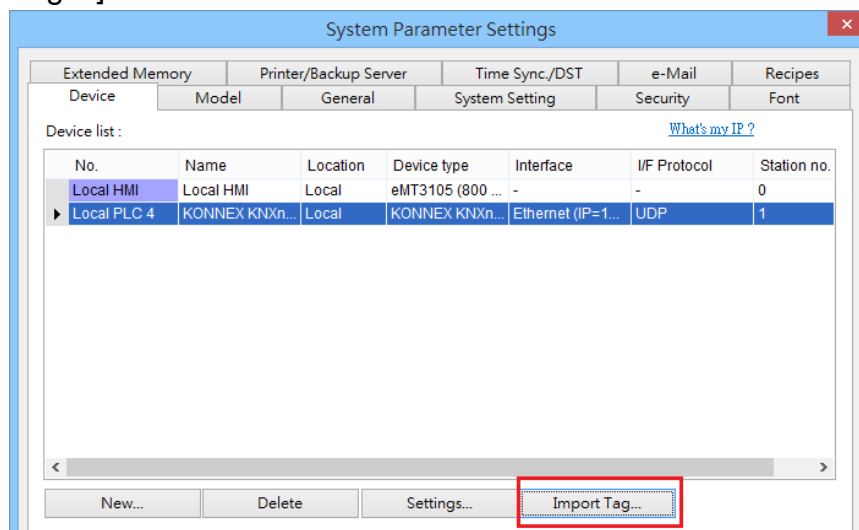
Data type	EasyBuilder data format	Memo
Bool	bit	
Byte	16-bit BCD, Hex, Binary, Unsigned	8-bit
SInt	16-bit BCD, Hex, Binary, Signed	8-bit
USInt	16-bit BCD, Hex, Binary, Unsigned	8-bit
Word	16-bit BCD, Hex, Binary, Unsigned	16-bit
Int	16-bit BCD, Hex, Binary, Signed	16-bit
UInt	16-bit BCD, Hex, Binary, Unsigned	16-bit
DWord	32-bit BCD, Hex, Binary, Unsigned	32-bit
DInt	32-bit BCD, Hex, Binary, Signed	32-bit
Real	32-bit Float	32-bit
UDInt	32-bit BCD, Hex, Binary, Unsigned	32-bit
Array	String	

PLC Setting:

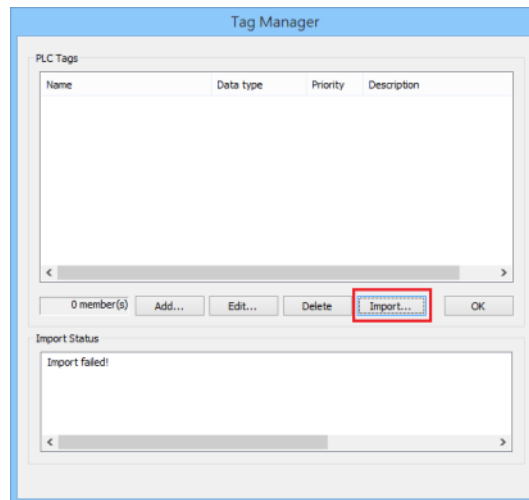
1. Export Tag file using ETS3 software.



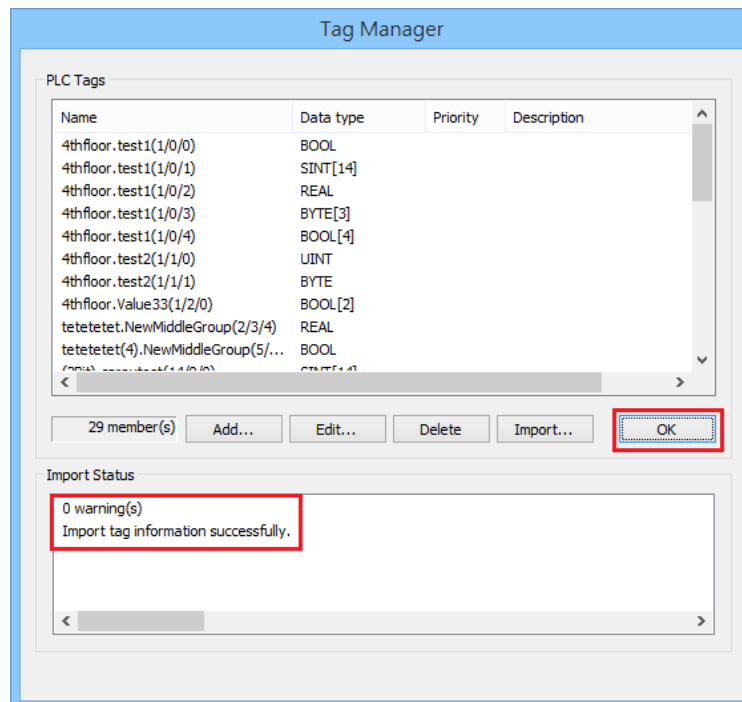
2. In EasyBuilder open System Parameter Settings, add **KONNEX KNXnet/IP** and then click [Import Tag...].



3. In Tag Manager dialog box click [Import...].



4. Select .esf file and then click [OK] to finish importing tags.



Wiring Diagram:

Ethernet cable:



Korenix 6550

Website: <http://www.korenix.com/>

HMI Setting:

Parameters	Recommended	Options	Notes
PLC type	Korenix 6550		Modbus protocol
PLC I/F	Ethernet		
Port no.	502		
PLC sta. no.		0	

Device Address:

Bit/Word	Device type	Format	Range	Memo
B	1x	DDDDD	1 ~ 65535	
B	0x	DDDDD	1 ~ 65535	
B	3x_Bit	DDDDDdd	100 ~ 6553515	
B	4x_Bit	DDDDDdd	100 ~ 6553515	
B	6x_Bit	DDDDDdd	100 ~ 6553515	
W	3x	DDDDD	1 ~ 65535	
W	4x	DDDDD	1 ~ 65535	
W	5x	DDDDD	1 ~ 65535	
W	6x	DDDDD	1 ~ 65535	

Wiring Diagram:

Diagram 1

Ethernet cable:



KOYO CLICK

Supported Series: KOYO CLICK PLC series

Website: <http://www.automationdirect.com>

HMI Setting:

Parameters	Recommended	Options	Notes
PLC type	KOYO CLICK		
PLC I/F	RS232		
Baud rate	38400	1200~115200	
Data bits	8		
Parity	Odd	Odd,Even,None	
Stop bits	1	1,2	
PLC sta. no.	1	1~247	
Turn around delay	5	5 ~ 10	

*Turn around delay should be set to 10 when the PLC firmware version is 2.1 or later.

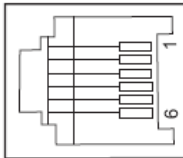
Device Address:

Bit/Word	Device type	Format	Range	Memo
B	X	Ddd	001 ~ 816	Input Status (Read Only)
B	Y	Ddd	001 ~ 816	Output Status
B	C	DDDD	1 ~ 2000	Control Bit
B	T	DDD	1 ~ 500	Timer Status (Read Only)
B	CT	DDD	1 ~ 250	Counter Status (Read Only)
B	SC	DDDD	1 ~ 1000	System Control Bit (Read Only)
W	DS	DDDD	1 ~ 4500	Data Registers
W	DD	DDDD	1 ~ 1000	Data Registers (Double Word)
W	DH	DDD	1 ~ 500	Data Registers
W	DF	DDD	1 ~ 500	Data Registers (Double Word)
W	XD	D	0 ~ 8	Input Status Registers (Read
W	YD	D	0 ~ 8	Output Status Registers
W	TD	DDD	1 ~ 500	Timer Current Values (Read Only)
W	CTD	DDD	1 ~ 250	Counter Current Values (Double Word/Read Only)
W	SD	DDDD	1 ~ 1000	System Data Registers (Read Only)
W	TXT	DDDD	1 ~ 1000	Text Data Registers

Wiring Diagram:

KOYO CLICK PLC Com Port:

6 pin RJ12 Phone
Type Jack – both ports



Port 1 Pin Descriptions		
1	0V	Power (-) connection (GND)
2	5V	Power (+) connection
3	RXD	Receive data (RS-232)
4	TXD	Transmit data (RS-232)
5	NC	No connection
6	0V	Power (-) connection (GND)

Port 2 Pin Descriptions		
1	0V	Power (-) connection (GND)
2	5V	Power (+) connection
3	RXD	Receive data (RS-232)
4	TXD	Transmit data (RS-232)
5	RTS	Request to send
6	0V	Power (-) connection (GND)

Diagram 1

cMT Series	cMT3151
eMT Series	eMT3070/ eMT3105 / eMT3120 / eMT3150
MT-iE	MT8073iE / MT8102iE
MT-XE	MT8092XE
MT-iP	MT6103iP

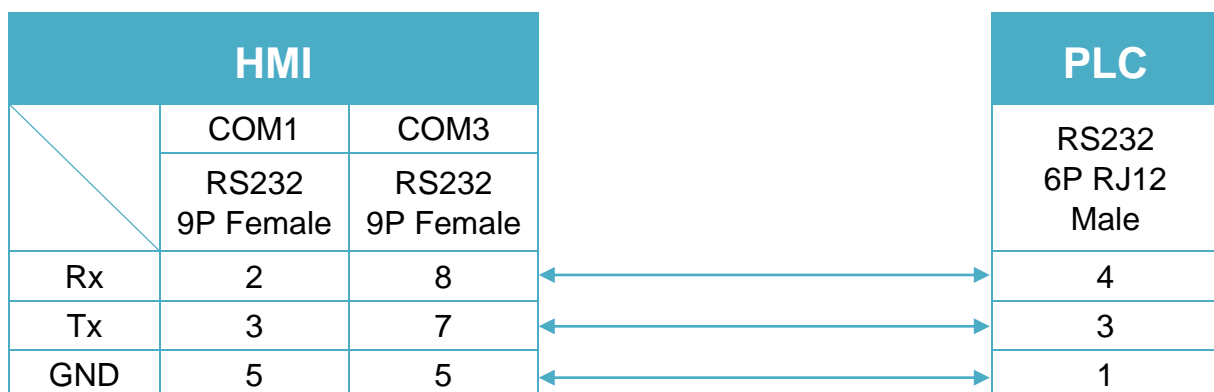


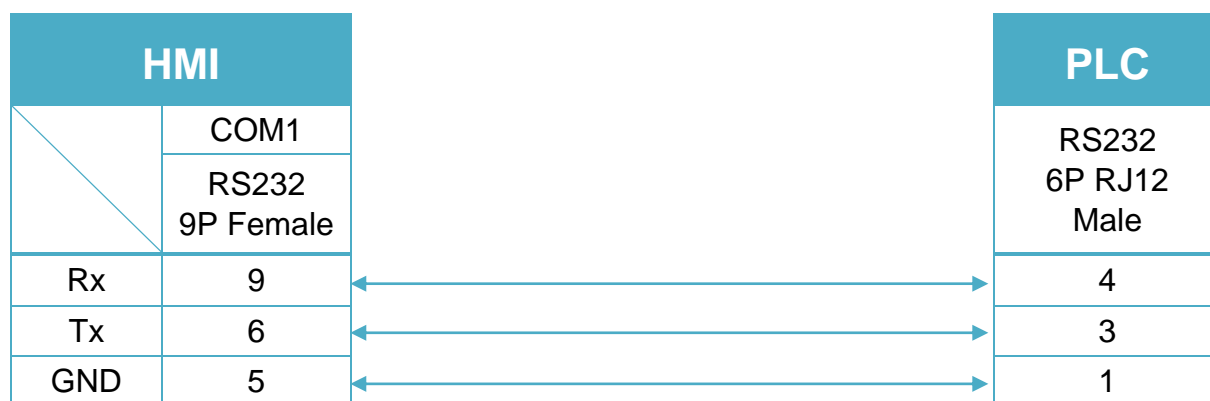
Diagram 2

cMT Series	cMT-SVR
mTV	mTV
MT-iE	MT8070iE / MT6070iE / MT8100iE / MT8121iE / MT8150iE / MT8071iE / MT6071iE / MT8072iE / MT6072iE / MT8073iE / MT8101iE / MT8102iE / MT8103iE
MT-XE	MT8121XE / MT8150XE / MT8090XE



Diagram 3

MT-iE	MT8050iE
MT-iP	MT6051iP / MT6071iP / MT8071iP



KOYO CLICK (Ethernet)

Supported Series: KOYO CLICK PLC series

Website: <http://www.automationdirect.com>

HMI Setting:

Parameters	Recommended	Options	Notes
PLC type	KOYO CLICK (Ethernet)		
PLC I/F	Ethernet		USE UDP
Port no.	25425		
Turn around delay	0	100~	*Note
PLC sta. no.	No need to set station no.		

*Note : When the communication is not stable, please adjust the parameter of [turn around delay] till the communication is normal.

Device Address:

Bit/Word	Device type	Format	Range	Memo
B	X	Ddd	1 ~ 816	
B	Y	Ddd	1 ~ 816	
B	C	DDDD	1 ~ 2000	
B	T	DDD	1 ~ 500	
B	CT	DDD	1 ~ 250	
B	SC	DDDD	1 ~ 1000	
W	DS	DDDD	1 ~ 4500	
DW	DD	DDDD	1 ~ 1000	
W	DH	DDD	1 ~ 500	
DW	DF	DDD	1 ~ 500	
W	XD	D	0 ~ 8	
W	YD	D	0 ~ 8	
W	TD	DDD	1 ~ 500	
DW	CTD	DDD	1 ~ 250	
W	SD	DDDD	1 ~ 1000	
W	TXT	DDDD	1 ~ 1000	

Wiring Diagram:

Diagram 1

Ethernet cable:



KOYO DIRECT

Supported Series: KOYO DirectLogic series PLC DL05, DL06, DL105, DL205, DL305, and DL405 series.

Website: <http://www.automationdirect.com>

HMI Setting:

Parameters	Recommended	Options	Notes
PLC type	KOYO DIRECT		
PLC I/F	RS232	RS232, RS485	
Baud rate	9600	9600, 19200, 38400	
Data bits	8	7, 8	
Parity	Odd	Even, Odd, None	
Stop bits	1	1	
PLC sta. no.	1	1-90	

PLC Setting:

1. The PLC must not have a password.
2. PLC must be set for Full Duplex operation.
3. PLC must be set for No Hardware Handshaking.
4. The PLC must be set to use the 'K' Sequence Protocol.
5. Set the mode switch to the TERM mode.
6. When using the D4-440 CPU, the station number must be set to 1.

Device Address:

Bit/Word	Device type	Format	Range	Memo
B	X	OOOO	0 ~ 4000	Input Bits
B	Y	OOOO	0 ~ 4000	Output Bits
B	C	OOOOO	0 ~ 10000	Control Relays
B	T	OOOO	0 ~ 1000	Timer Status Bits
B	CT	OOOO	0 ~ 1000	Counter Status Bits
B	S	OOOO	0 ~ 2000	
B	SP	OOOO	0 ~ 2000	
B	GX	OOOOO	0 ~ 10000	
B	GY	OOOOO	0 ~ 10000	

Bit/Word	Device type	Format	Range	Memo
W	V	OOOOO	0 ~ 77777	V Memory
W	Timer	OOOO	0 ~ 1000	
W	Counter	OOOO	0 ~ 1000	

Wiring Diagram:

DL05/DL06/DL105/DL230/DL240/DL250/DL350/DL450 RS232 port (Diagram 1 ~ Diagram 3)

Diagram 1

cMT Series	<i>cMT3151</i>
eMT Series	<i>eMT3070 / eMT3105 / eMT3120 / eMT3150</i>
MT-iE	<i>MT8073iE / MT8102iE</i>
MT-XE	<i>MT8092XE</i>
MT-iP	<i>MT6103iP</i>

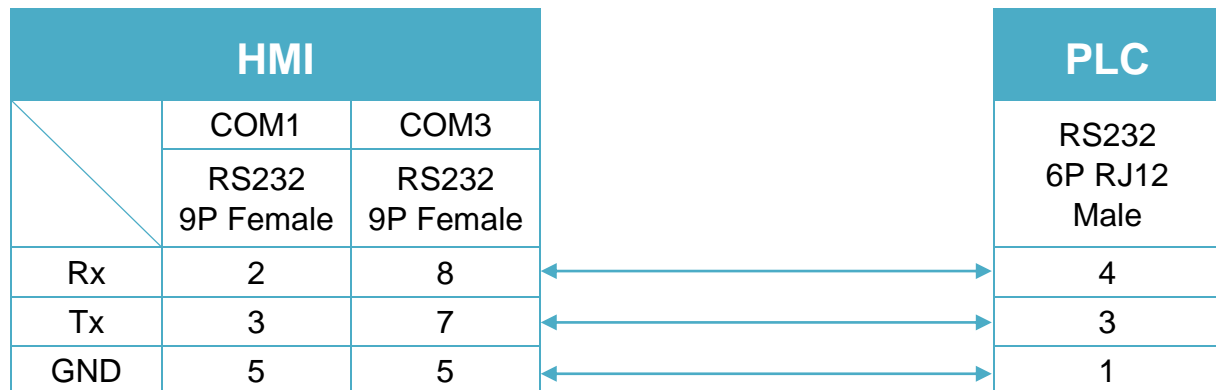


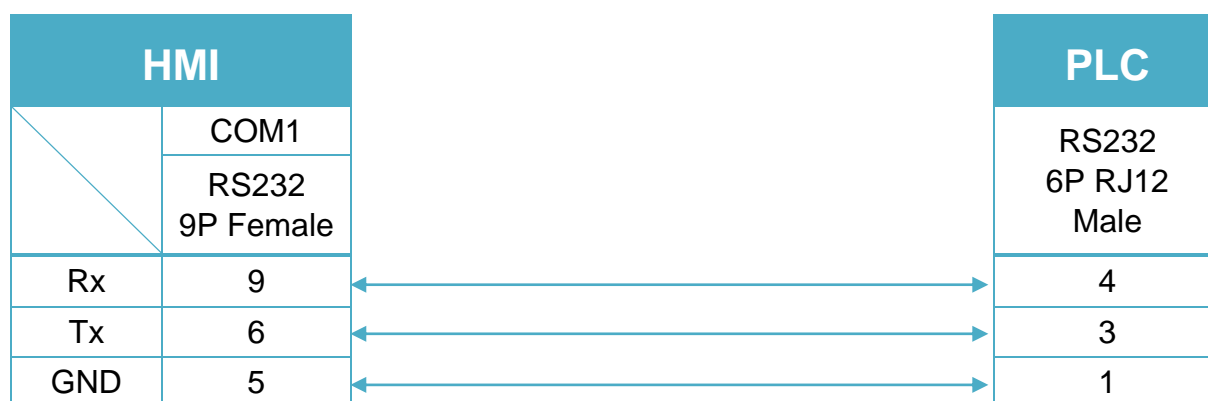
Diagram 2

cMT Series	cMT-SVR
mTV	mTV
MT-iE	MT8070iE / MT6070iE / MT8100iE / MT8121iE / MT8150iE / MT8071iE / MT6071iE / MT8072iE / MT6072iE / MT8073iE / MT8101iE / MT8102iE / MT8103iE
MT-XE	MT8121XE / MT8150XE / MT8090XE



Diagram 3

MT-iE	MT8050iE
MT-iP	MT6051iP / MT6071iP / MT8071iP



CPU unit: DL06/DL250 CPU Port2 RS232 (Diagram 4 ~ Diagram 6)

Diagram 4

cMT Series	<i>cMT3151</i>
eMT Series	<i>eMT3070 / eMT3105 / eMT3120 / eMT3150</i>
MT-iE	<i>MT8073iE / MT8102iE</i>
MT-XE	<i>MT8092XE</i>
MT-iP	<i>MT6103iP</i>

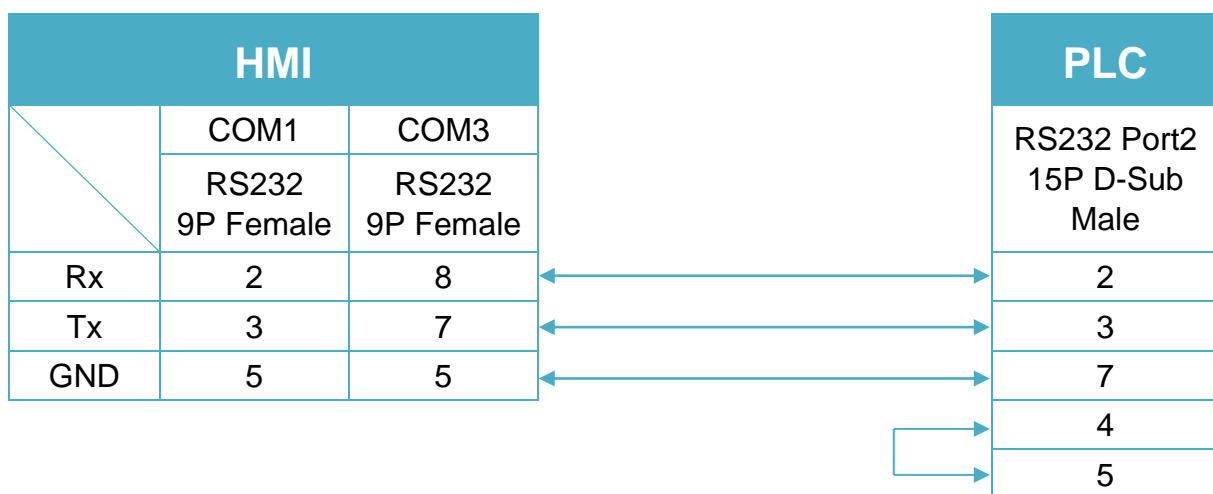


Diagram 5

cMT Series	cMT-SVR
mTV	mTV
MT-iE	MT8070iE / MT6070iE / MT8100iE / MT8121iE / MT8150iE / MT8071iE / MT6071iE / MT8072iE / MT6072iE / MT8073iE / MT8101iE / MT8102iE / MT8103iE
MT-XE	MT8121XE / MT8150XE / MT8090XE /

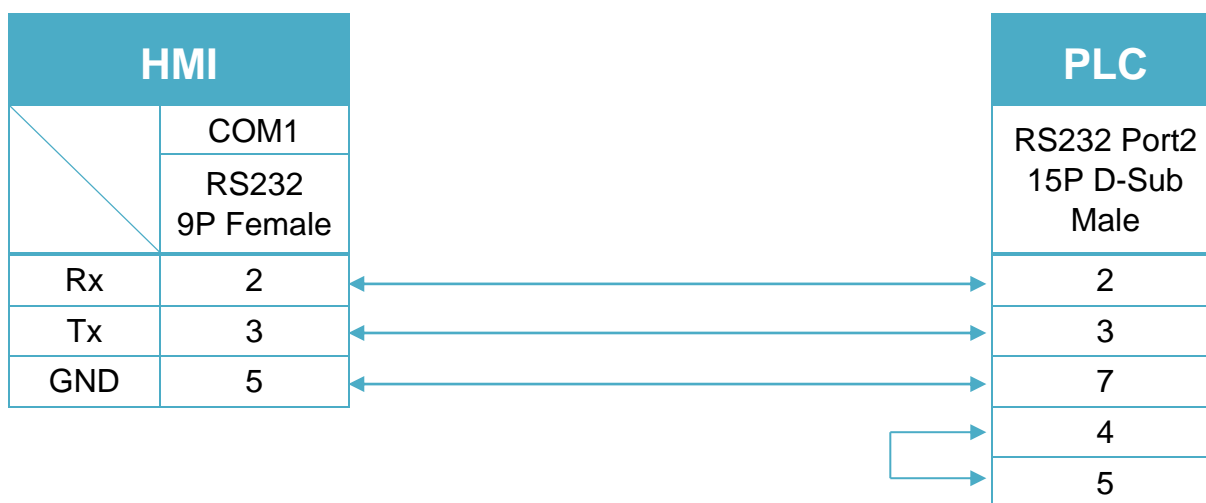
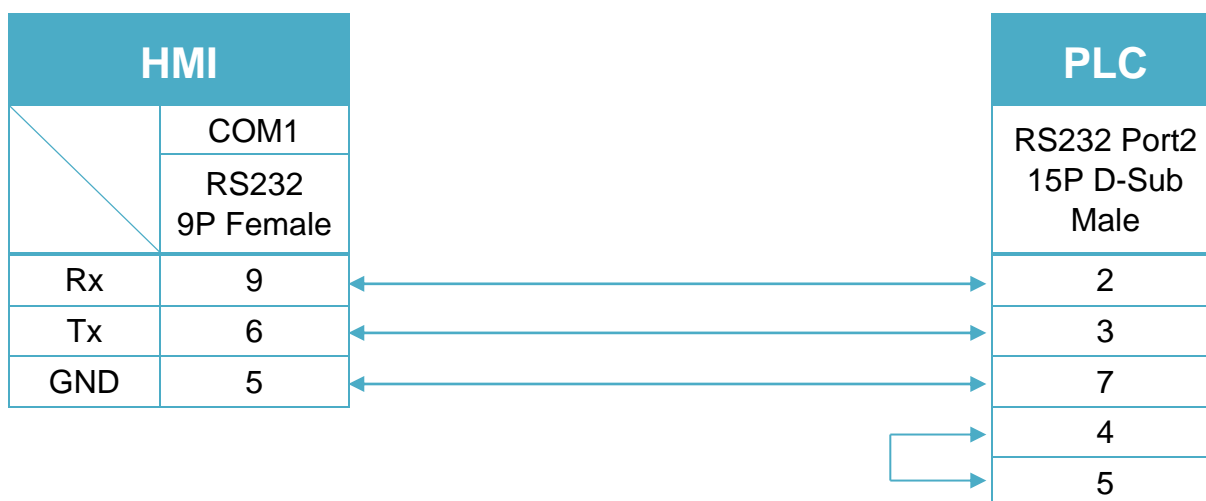


Diagram 6

MT-iE	MT8050iE
MT-iP	MT6051iP / MT6071iP / MT8071iP



CPU unit: DL06/DL250 CPU Port2 RS422 (Diagram 7 ~ Diagram 10)

Diagram 7

cMT Series	<i>cMT3151</i>
eMT Series	<i>eMT3070 / eMT3105 / eMT3120 / eMT3150</i>
MT-iE	<i>MT8070iE / MT6070iE / MT8100iE / MT8121iE / MT8150iE</i>
MT-XE	<i>MT8121XE / MT8150XE</i>

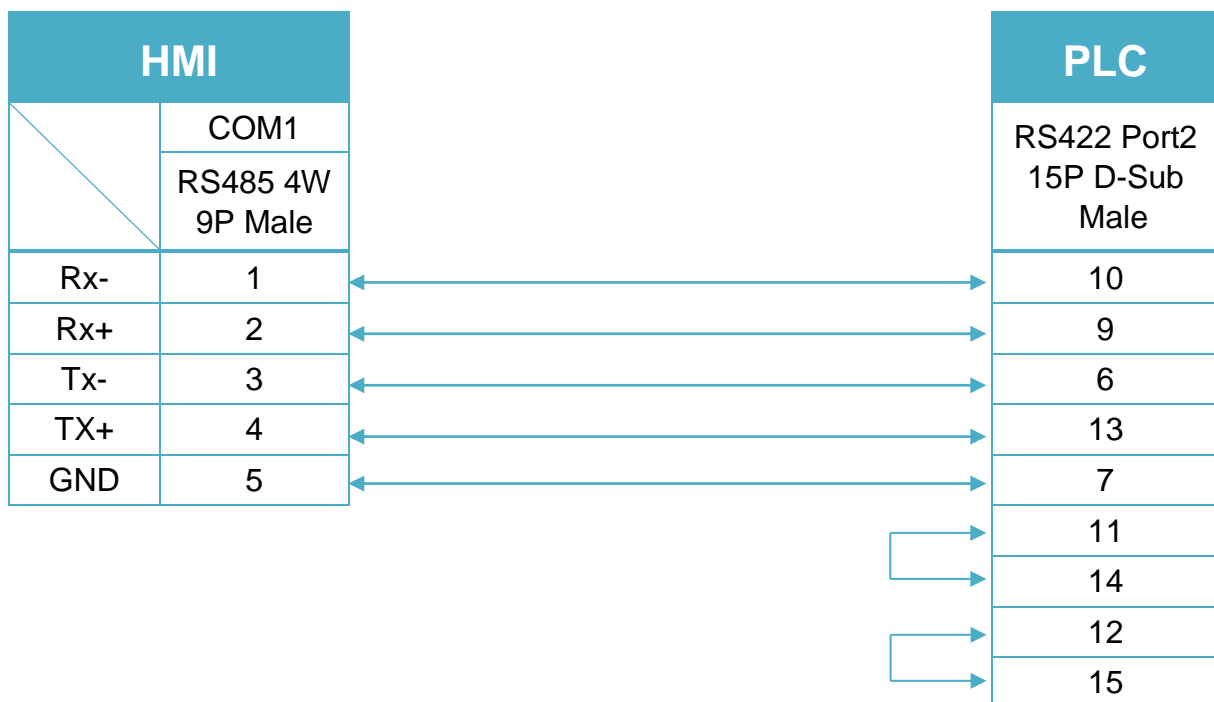


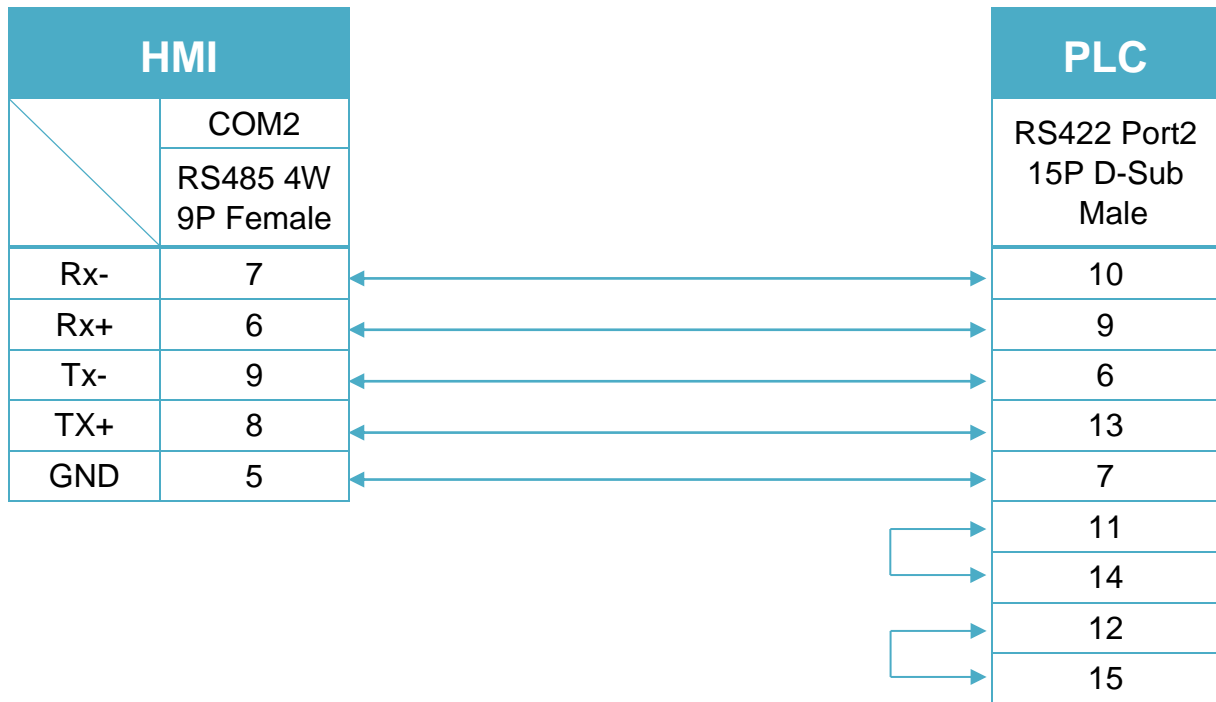
Diagram 8
cMT Series
cMT-SVR
mTV
mTV


Diagram 9

MT-iE	<i>MT8071iE / MT6071iE / MT8072iE / MT6072iE / MT8073iE / MT8101iE / MT8102iE / MT8103iE</i>
MT-XE	<i>MT8090XE / MT8092XE</i>
MT-iP	<i>MT6071iP / MT8071iP / MT6103iP</i>

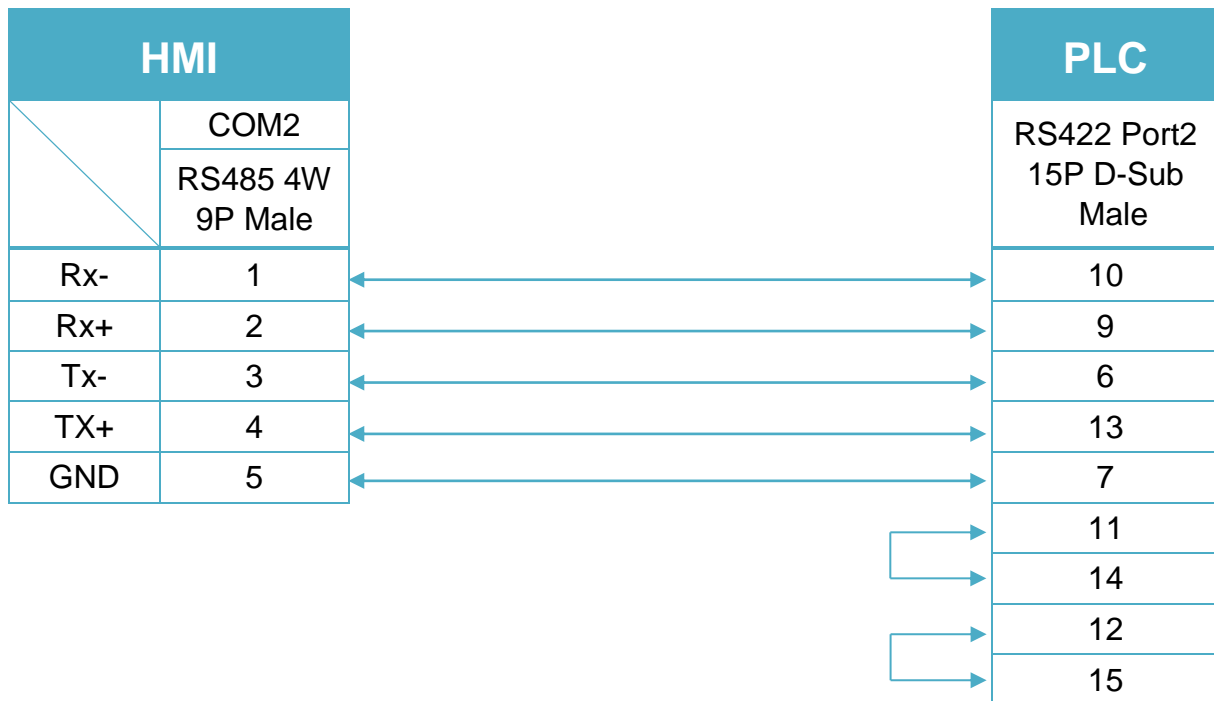
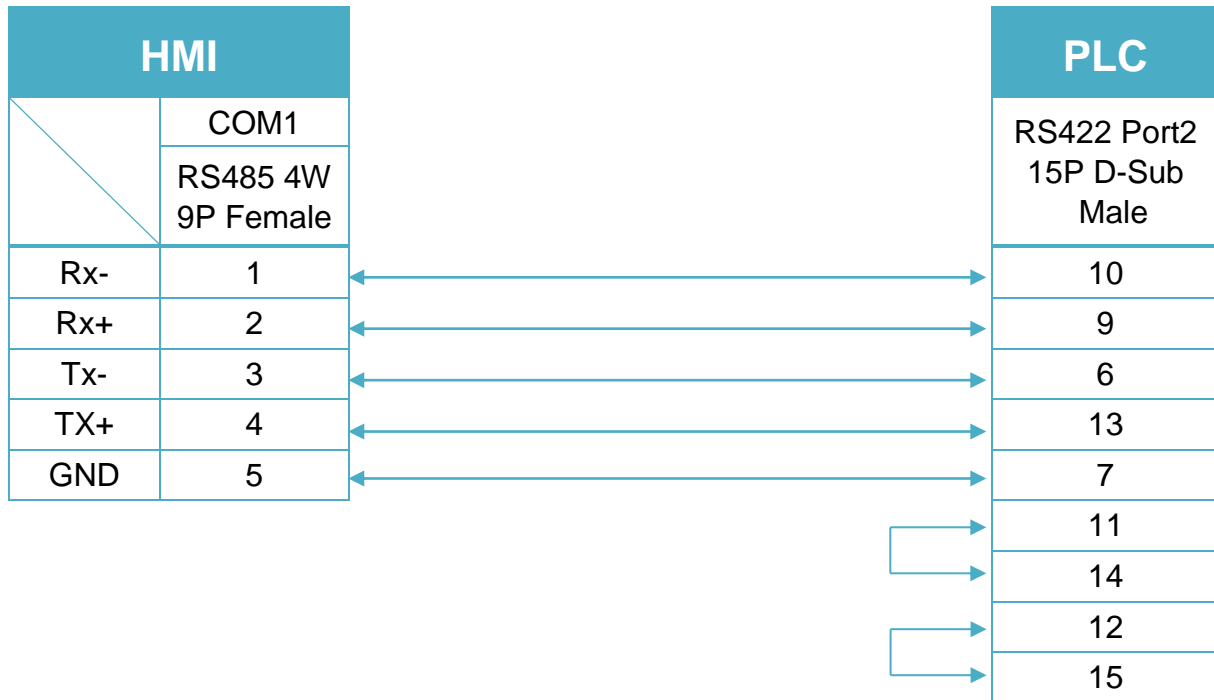


Diagram 10

MT-iE *MT8050iE*

MT-iP *MT6051iP*



Note: DL06/DL250 CPU Port2 include RS232 and RS422

The following is the view from the soldering point of a connector.

DL430/DL440/DL450 CPU unit Port0 RS232
(Diagram 11 ~ Diagram 13)

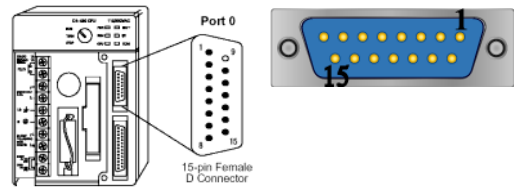


Diagram 11

cMT Series	<i>cMT3151</i>
eMT Series	<i>eMT3070 / eMT3105 / eMT3120 / eMT3150</i>
MT-iE	<i>MT8073iE / MT8102iE</i>
MT-XE	<i>MT8092XE</i>
MT-iP	<i>MT6103iP</i>

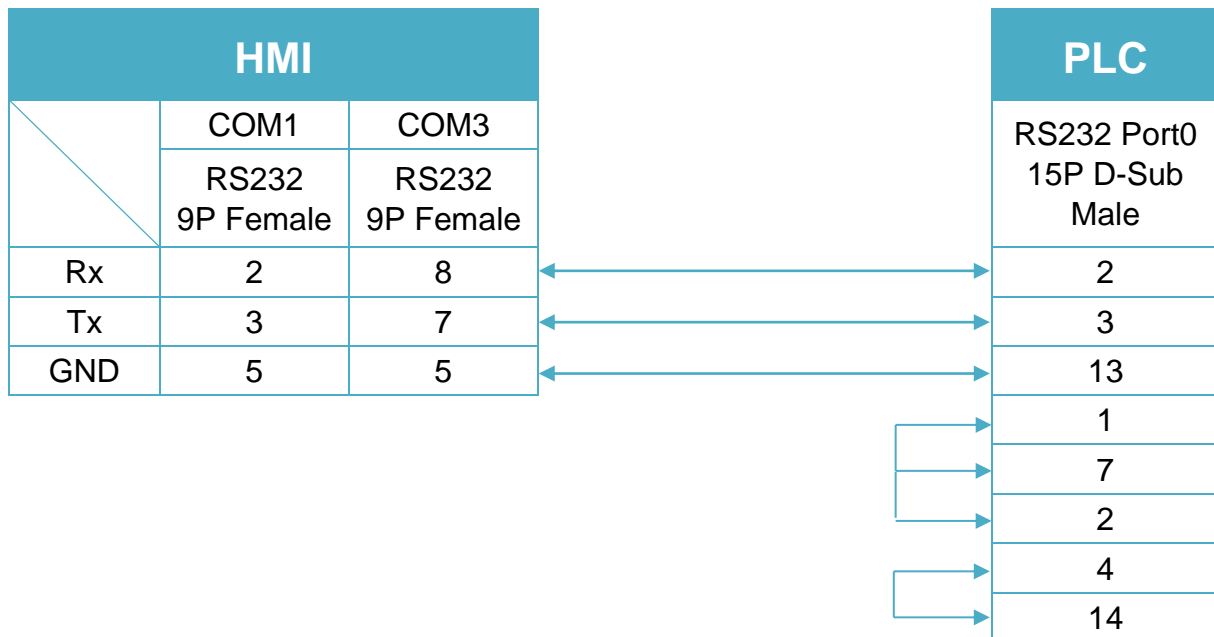


Diagram 12

cMT Series	cMT-SVR
mTV	mTV
MT-iE	MT8070iE / MT6070iE / MT8100iE / MT8121iE / MT8150iE / MT8071iE / MT6071iE / MT8072iE / MT6072iE / MT8073iE / MT8101iE / MT8102iE / MT8103iE
MT-XE	MT8121XE / MT8150XE / MT8090XE /

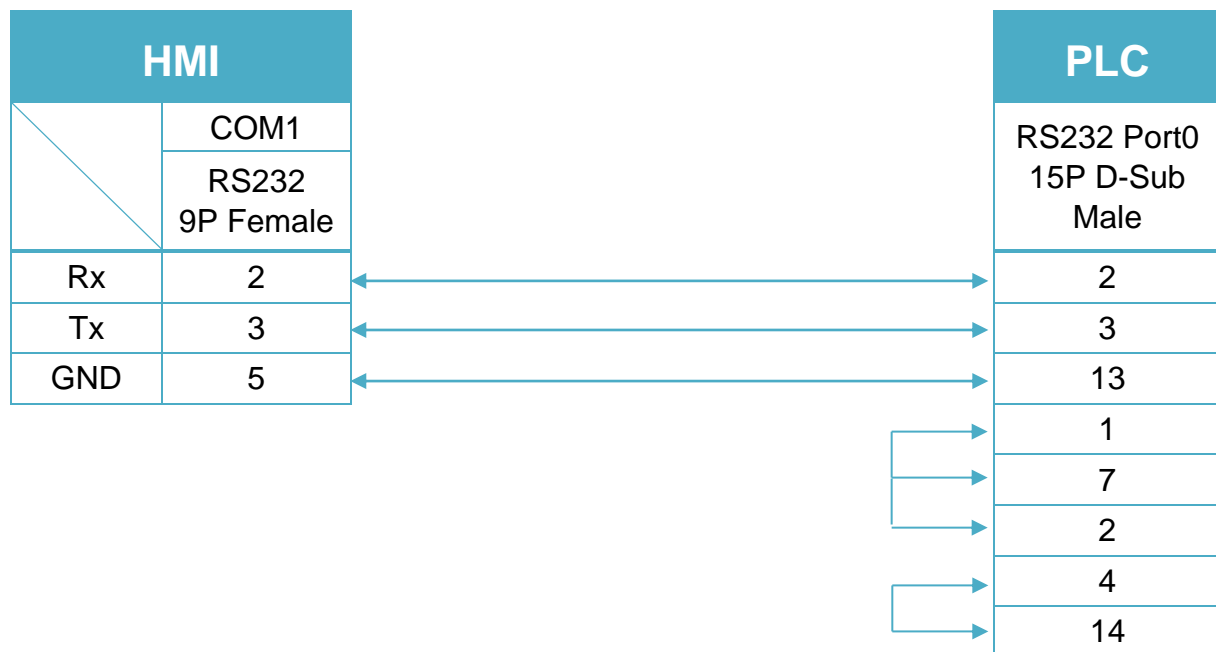
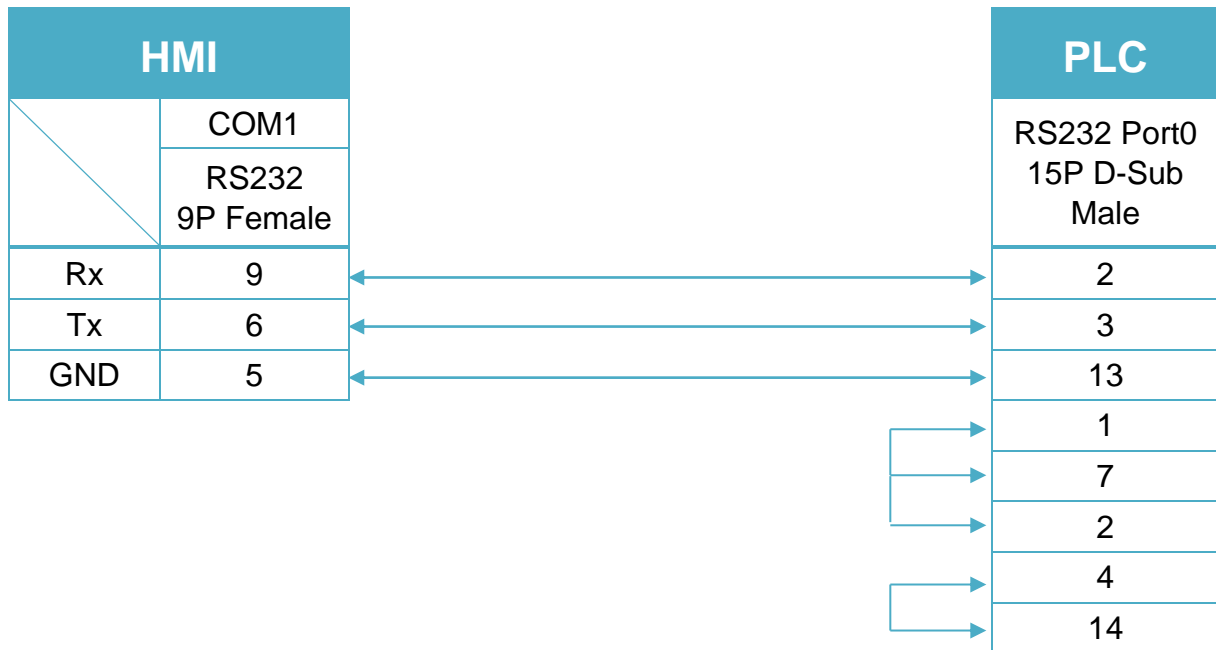
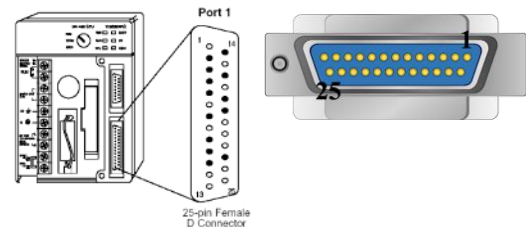


Diagram 13

MT-iE
MT8050iE
MT-iP
MT6051iP / MT6071iP / MT8071iP


The following is the view from the soldering point of a connector.



CPU unit: DL430/DL440/DL450 CPU
 unit Port1 & DL350 CPU unit Port2 RS232
 (Diagram 14 ~ Diagram 16)

Diagram 14

cMT Series	<i>cMT3151</i>
eMT Series	<i>eMT3070/ eMT3105 / eMT3120 / eMT3150</i>
MT-iE	<i>MT8073iE / MT8102iE</i>
MT-XE	<i>MT8092XE</i>
MT-iP	<i>MT6103iP</i>

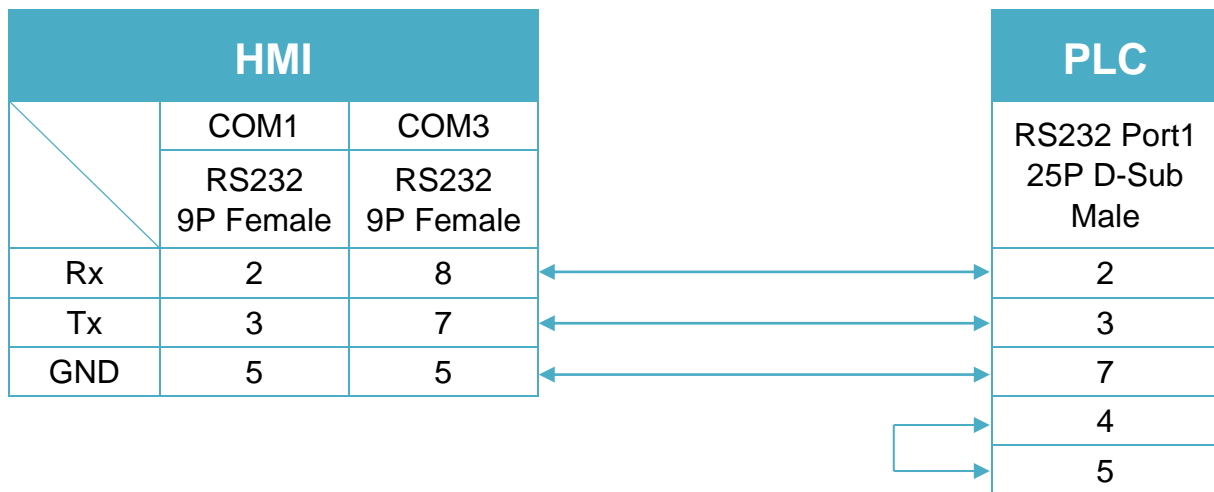


Diagram 15

cMT Series	cMT-SVR
mTV	mTV
MT-iE	MT8070iE / MT6070iE / MT8100iE / MT8121iE / MT8150iE / MT8071iE / MT6071iE / MT8072iE / MT6072iE / MT8073iE / MT8101iE / MT8102iE / MT8103iE
MT-XE	MT8121XE / MT8150XE / MT8090XE /

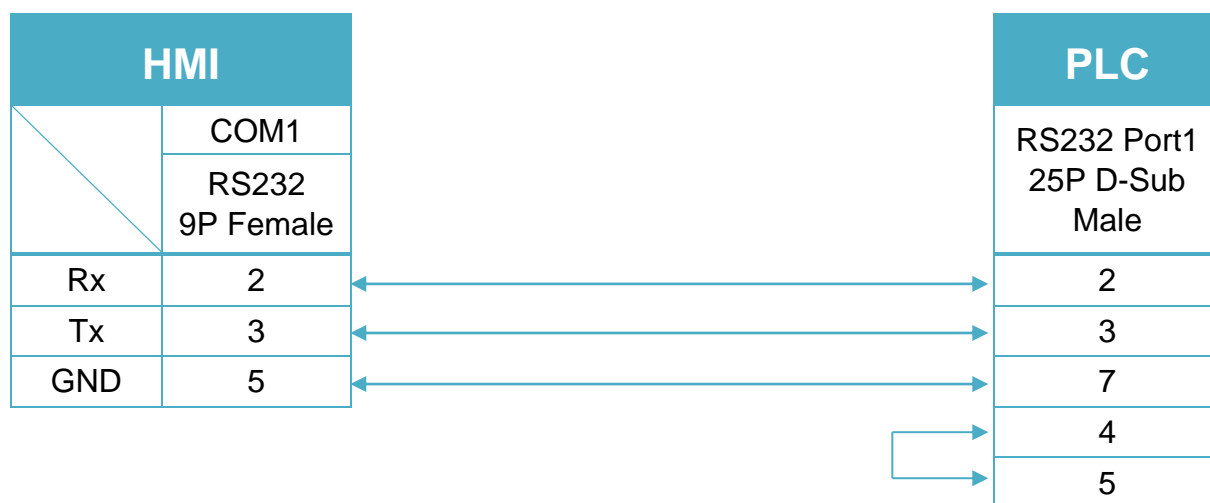
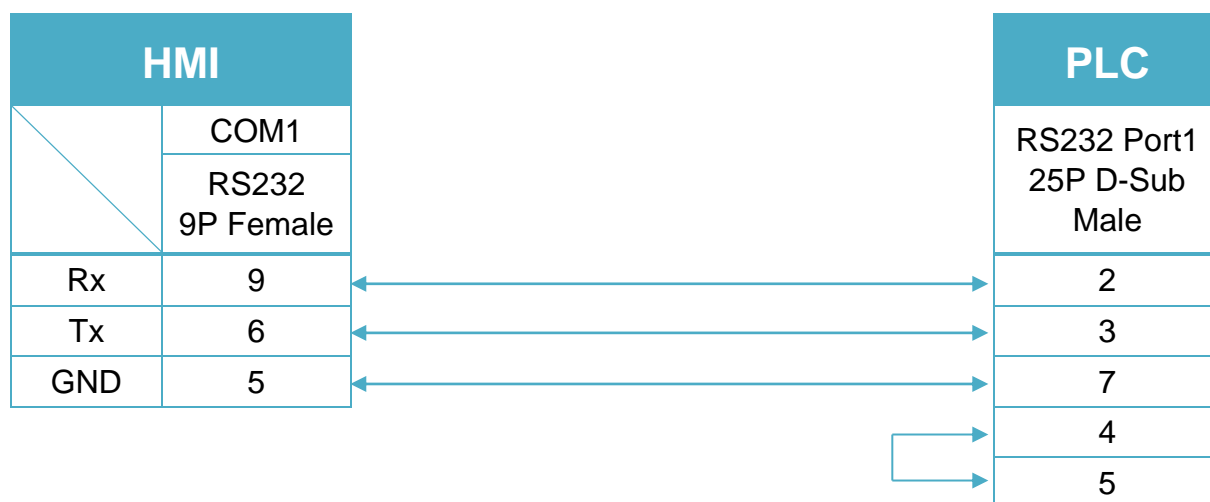


Diagram 16

MT-iE	MT8050iE
MT-iP	MT6051iP / MT6071iP / MT8071iP



CPU unit: DL430/DL440/DL450 CPU unit Port1 & DL350 CPU unit Port2 RS422
 (Diagram 17 ~ Diagram 20)

Diagram 17

cMT Series	<i>cMT3151</i>
eMT Series	<i>eMT3070 / eMT3105 / eMT3120 / eMT3150</i>
MT-iE	<i>MT8070iE / MT6070iE / MT8100iE / MT8121iE / MT8150iE</i>
MT-XE	<i>MT8121XE / MT8150XE</i>

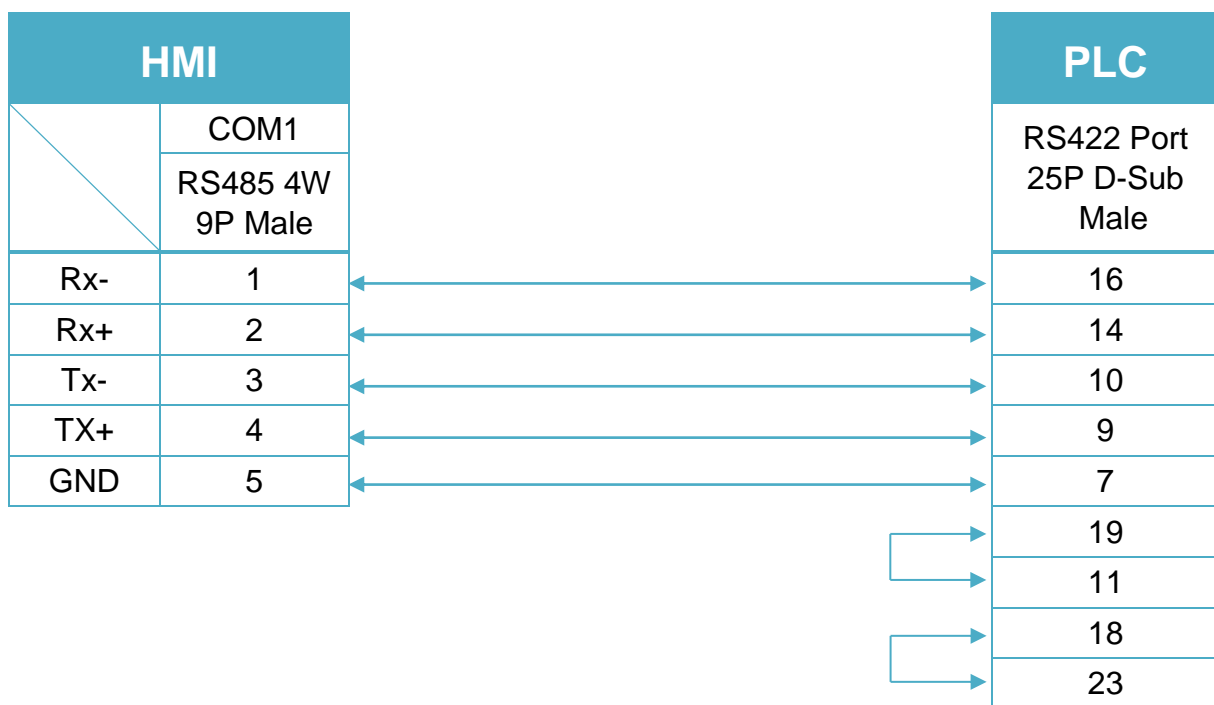


Diagram 18

cMT Series *cMT-SVR*

mTV *mTV*

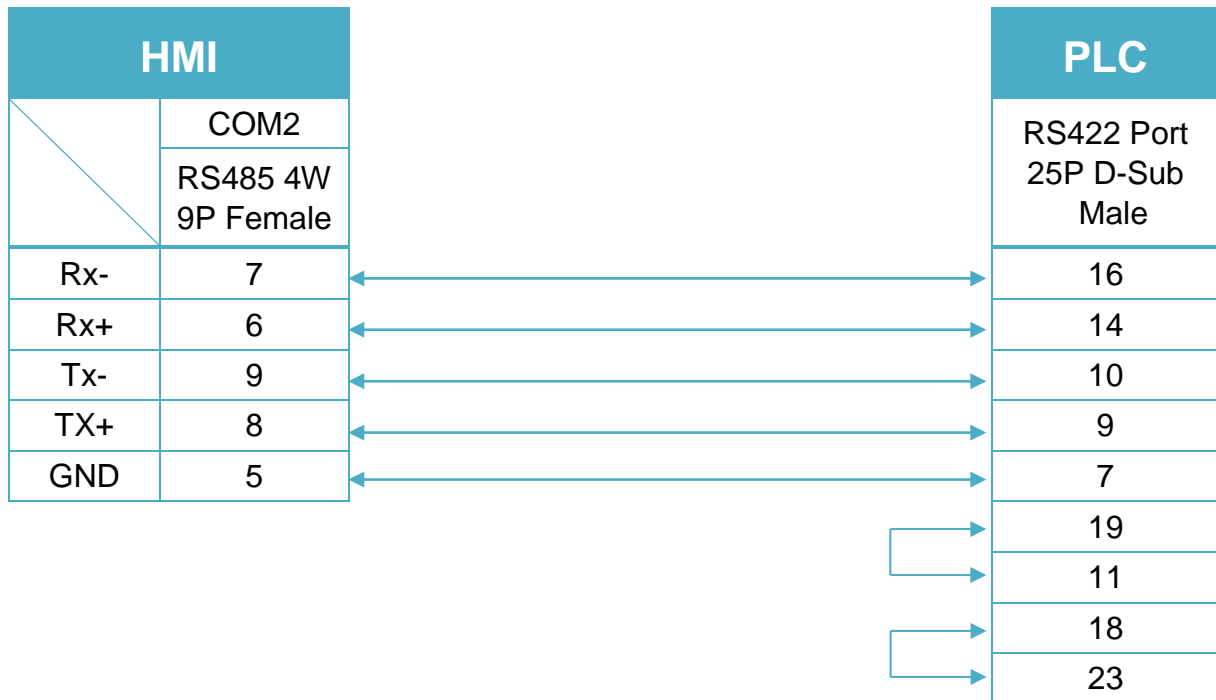


Diagram 19

MT-iE	<i>MT8071iE / MT6071iE / MT8072iE / MT6072iE / MT8073iE / MT8101iE / MT8102iE / MT8103iE</i>
MT-XE	<i>MT8090XE / MT8092XE</i>
MT-iP	<i>MT6071iP / MT8071iP / MT6103iP</i>

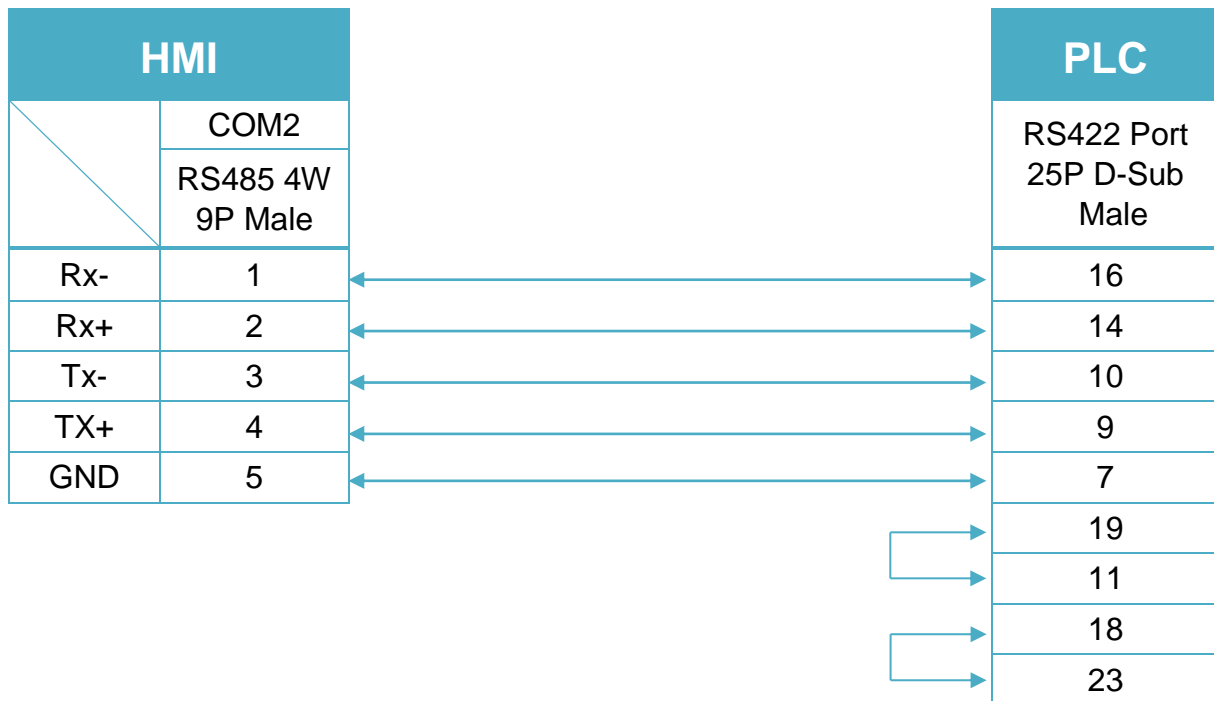
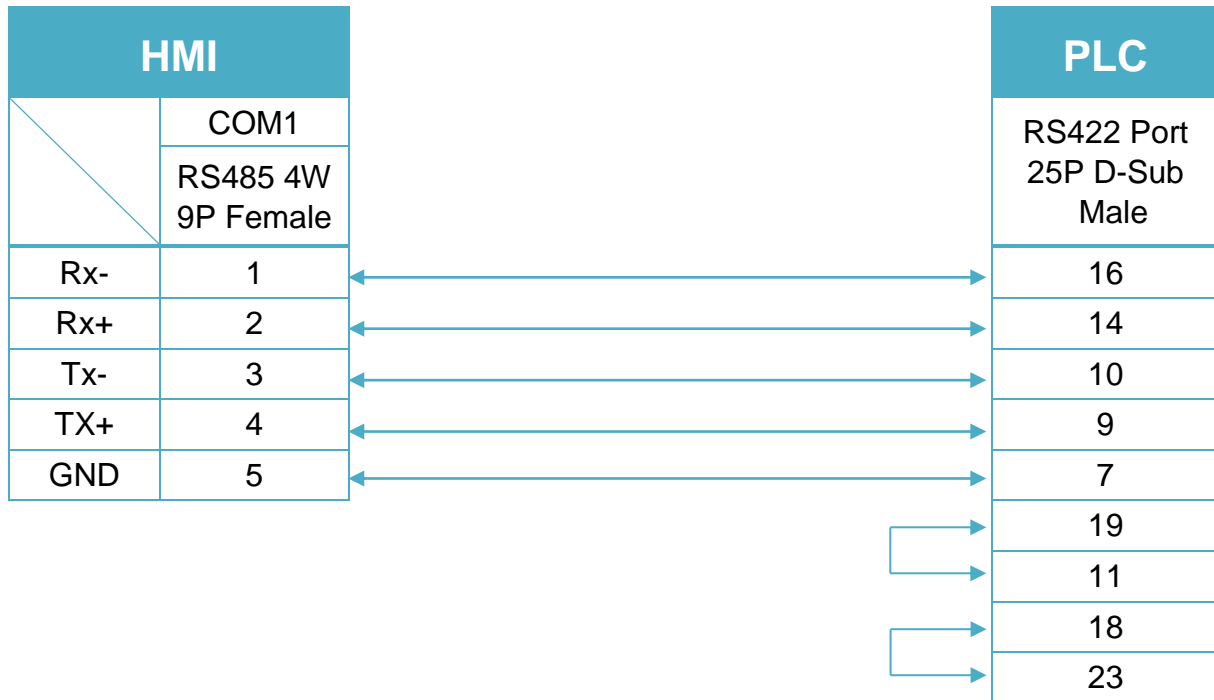


Diagram 20

MT-iE *MT8050iE*

MT-iP *MT6051iP*



CPU unit: DL450 CPU unit Port3 RS422 (Diagram 21 ~ Diagram 24)

Diagram 21

cMT Series	<i>cMT3151</i>
eMT Series	<i>eMT3070 / eMT3105 / eMT3120 / eMT3150</i>
MT-iE	<i>MT8070iE / MT6070iE / MT8100iE / MT8121iE / MT8150iE</i>
MT-XE	<i>MT8121XE / MT8150XE</i>

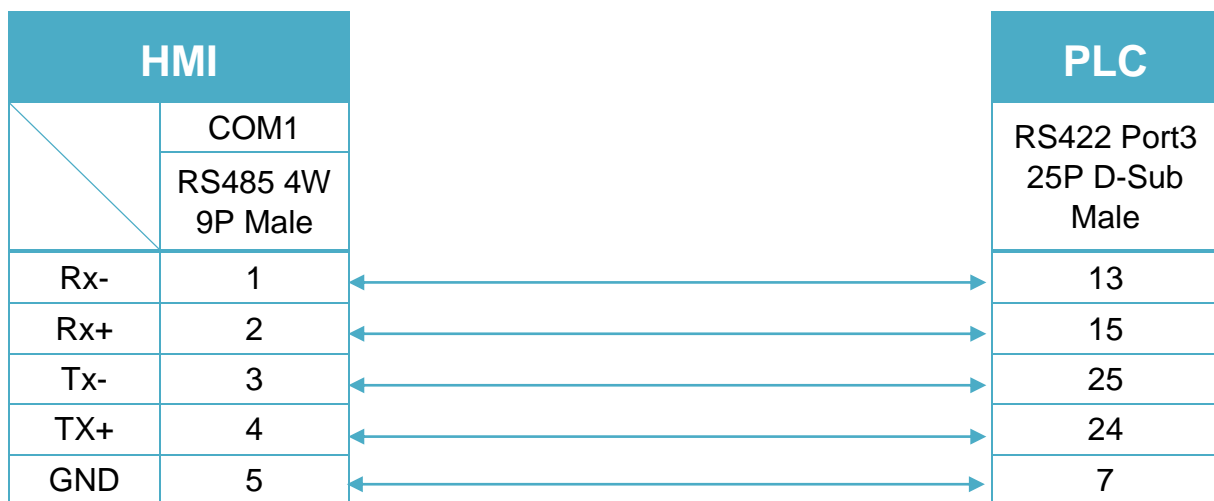


Diagram 22

cMT Series	<i>cMT-SVR</i>
mTV	<i>mTV</i>

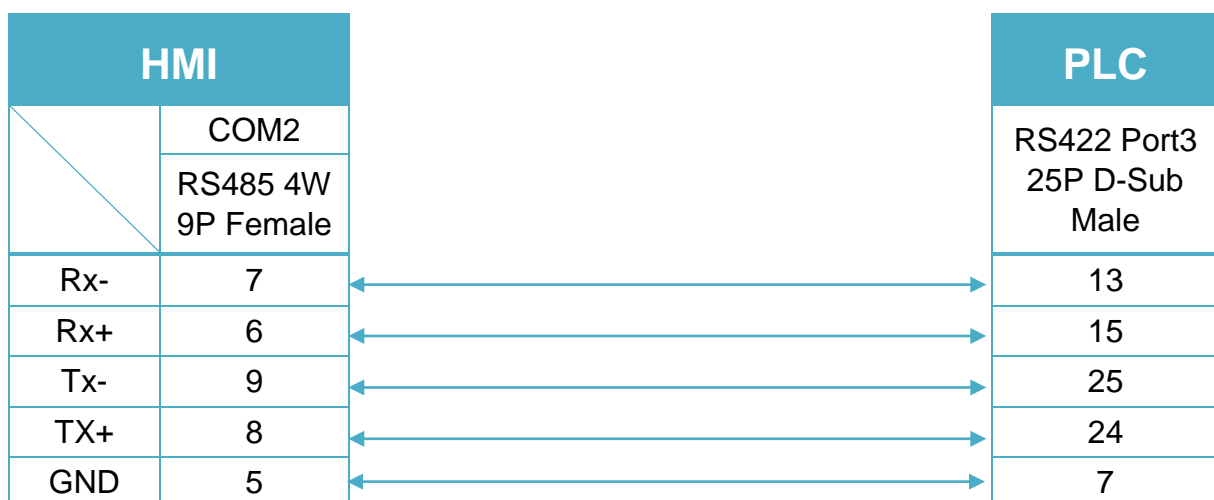


Diagram 23

MT-iE	<i>MT8071iE / MT6071iE / MT8072iE / MT6072iE / MT8073iE / MT8101iE / MT8102iE / MT8103iE</i>
MT-XE	<i>MT8090XE / MT8092XE</i>
MT-iP	<i>MT6071iP / MT8071iP / MT6103iP</i>

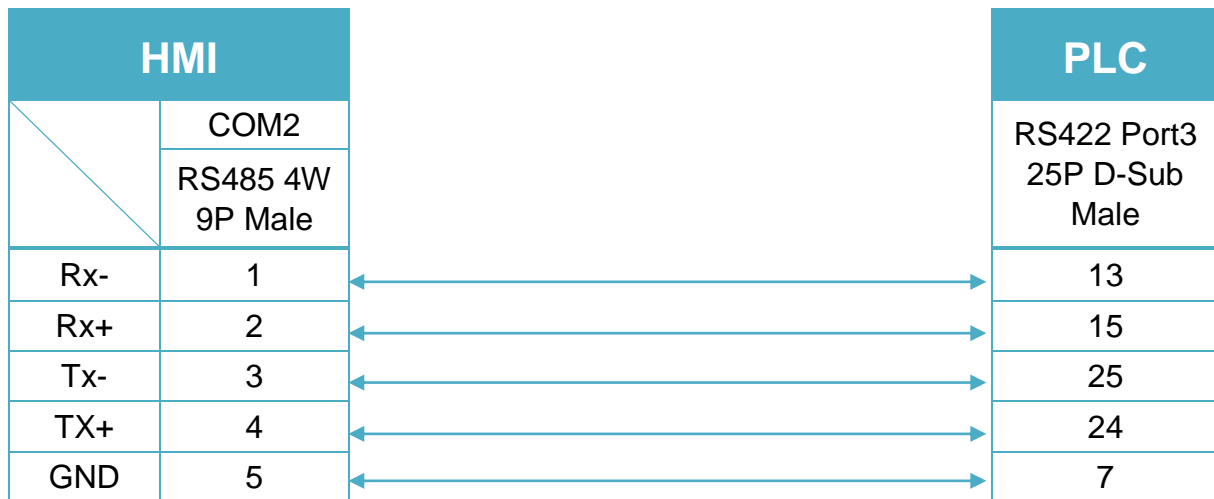
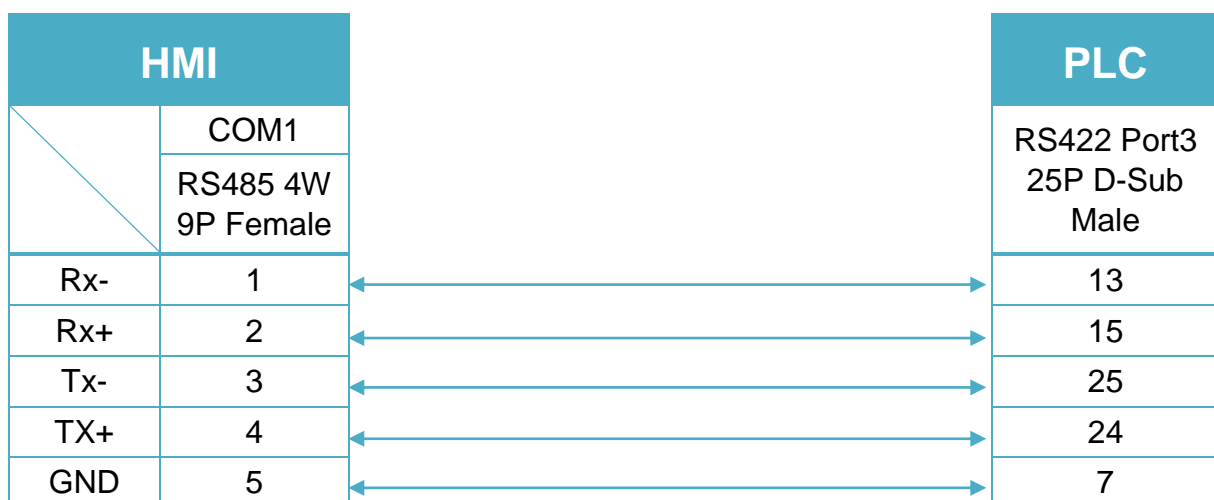


Diagram 24

MT-iE	<i>MT8050iE</i>
MT-iP	<i>MT6051iP</i>



Communication unit: DL205 series D2-DCM and DL405 series D4-DCM RS232

(Diagram 25 ~ Diagram 27)

Diagram 25

cMT Series	<i>cMT3151</i>
eMT Series	<i>eMT3070 / eMT3105 / eMT3120 / eMT3150</i>
MT-iE	<i>MT8073iE / MT8102iE</i>
MT-XE	<i>MT8092XE</i>
MT-iP	<i>MT6103iP</i>

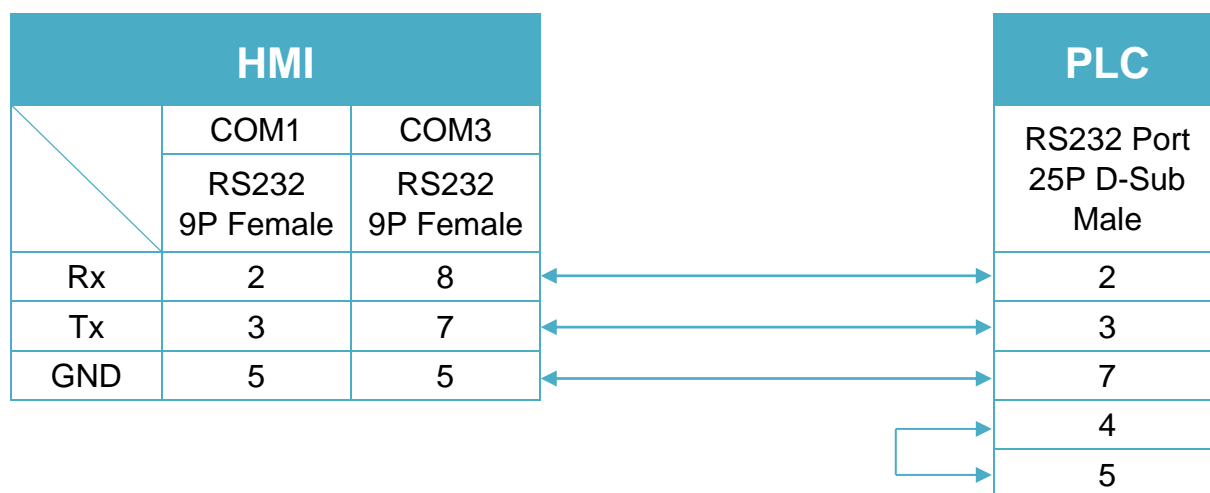


Diagram 26

cMT Series	cMT-SVR
mTV	mTV
MT-iE	MT8070iE / MT6070iE / MT8100iE / MT8121iE / MT8150iE / MT8071iE / MT6071iE / MT8072iE / MT6072iE / MT8073iE / MT8101iE / MT8102iE / MT8103iE
MT-XE	MT8121XE / MT8150XE / MT8090XE /

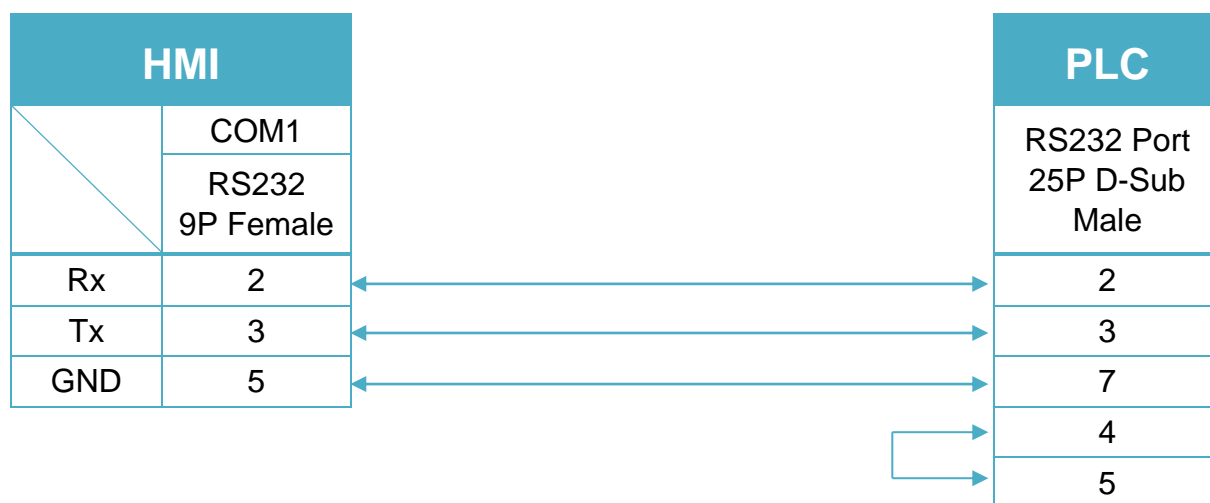
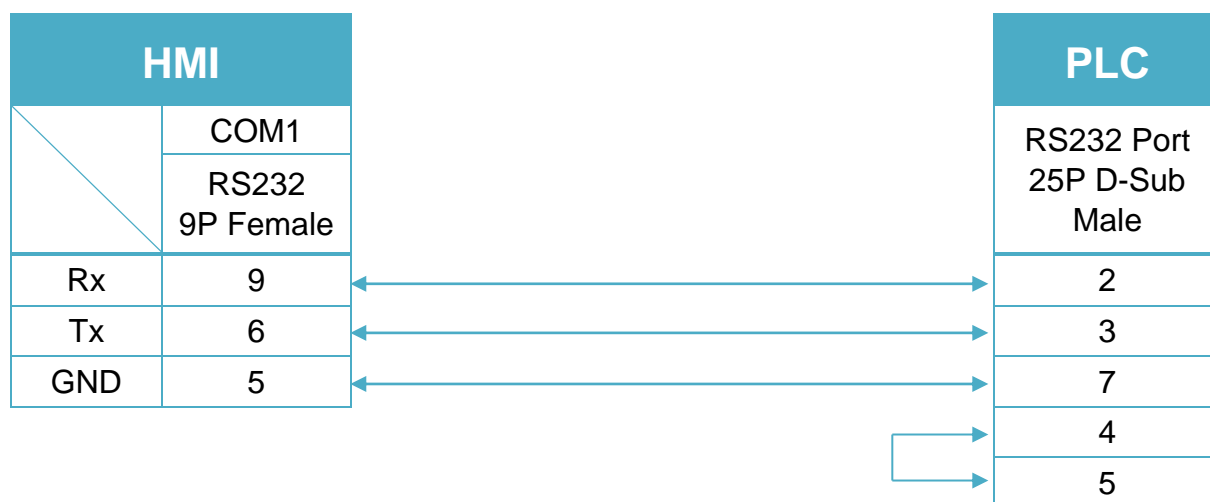


Diagram 27

MT-iE	MT8050iE
MT-iP	MT6051iP / MT6071iP / MT8071iP



KOYO Do-more

Supported Series: Do-more H2 Series PLC

Website: <http://www.automationdirect.com>

HMI Setting:

Parameters	Recommended	Options	Notes
PLC type	KOYO Do-more		
PLC I/F	RS232		
Baud rate	115200	9600 ~ 115200	
Data bits	8		
Parity	None		
Stop bits	1		
PLC sta. no.	1		

Online simulation	YES	Extend address mode	NO
-------------------	-----	---------------------	----

PLC Setting:

Serial Port Mode	Do-more programming
------------------	---------------------

Device Address:

Bit/Word	Device type	Format	Range	Memo
B	ST	DDDD	0 ~ 1023	
B	X	DDDDD	0 ~ 65535	
B	Y	DDDDD	0 ~ 65535	
B	C	DDDDD	0 ~ 65535	
B	MI	DDDDD	0 ~ 65535	
B	MC	DDDDD	0 ~ 65535	
B	T.Done	DDDDD	0 ~ 32766	Read only
B	CT.Done	DDDDD	0 ~ 32766	Read only
B	DLX	OOOOOO	0 ~ 177777	
B	DLY	OOOOOO	0 ~ 177777	
B	DLC	OOOOOO	0 ~ 177777	
W	DLV	OOOOOO	0 ~ 177777	
W	SDT	D.D	0 ~ 7.6	*Note 1

Bit/Word	Device type	Format	Range	Memo
W	WX	DDDDD	0 ~ 65535	
W	WY	DDDDD	0 ~ 65535	
W	V	DDDDD	0 ~ 65535	
W	N	DDDDD	0 ~ 65535	
W	SS	DDDD.DD	0 ~ 3854.34	Read only *Note 2
W	SL	DDDD.DDD	0 ~ 1007.130	Read only *Note 2
W	UDT	DDDDD.D	0 ~ 32767.6	*Note 1
W	PL	DDD	0 ~ 255	
W	MIR	DDDDD	0 ~ 65535	
W	MHR	DDDDD	0 ~ 65535	
W	DST	DDD	0 ~ 511	
W	D	DDDDD	0 ~ 65534	
W	R	DDDDD	0 ~ 65534	Real Number (float)
W	T.ACC	DDDDD	0 ~ 32766	
W	CT.ACC	DDDDD	0 ~ 32766	

*Note 1 : SDT , UDT: xxx.0 = Year, xxx.1 = Month, xxx.2 = Day, xxx.3 = DayOfWeek, xxx.4 = Hour, xxx.5 = Minute, xxx.6 = Second.

*Note 2 : SS , SL: xxx.0 = MaxLen, xxx.1 = Length, xxx.2 ~ 34 = String(SS)
xxx.2 ~ 130 = String (SL)

Wiring Diagram:

Diagram 1

cMT Series

cMT3151

eMT Series

eMT3070 / eMT3105 / eMT3120 / eMT3150

MT-iE

MT8073iE / MT8102iE

MT-XE

MT8092XE

MT-iP

MT6103iP

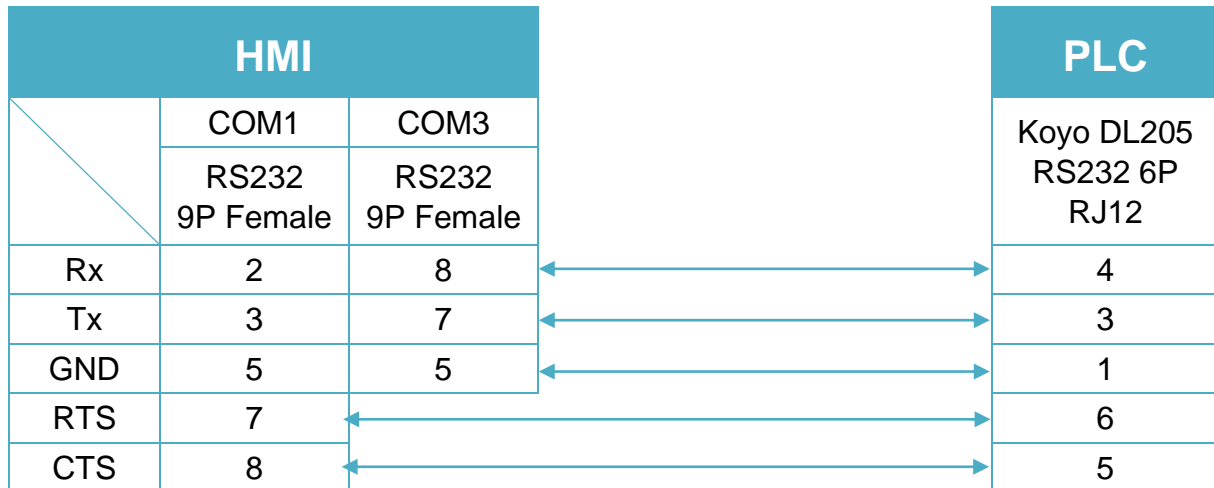


Diagram 2

MT-iE *MT8070iE / MT6070iE / MT8100iE / MT8121iE / MT8150iE /
MT8071iE / MT6071iE / MT8072iE / MT6072iE / MT8073iE /
MT8101iE / MT8102iE / MT8103iE*

MT-XE *MT8121XE / MT8150XE / MT8090XE /*

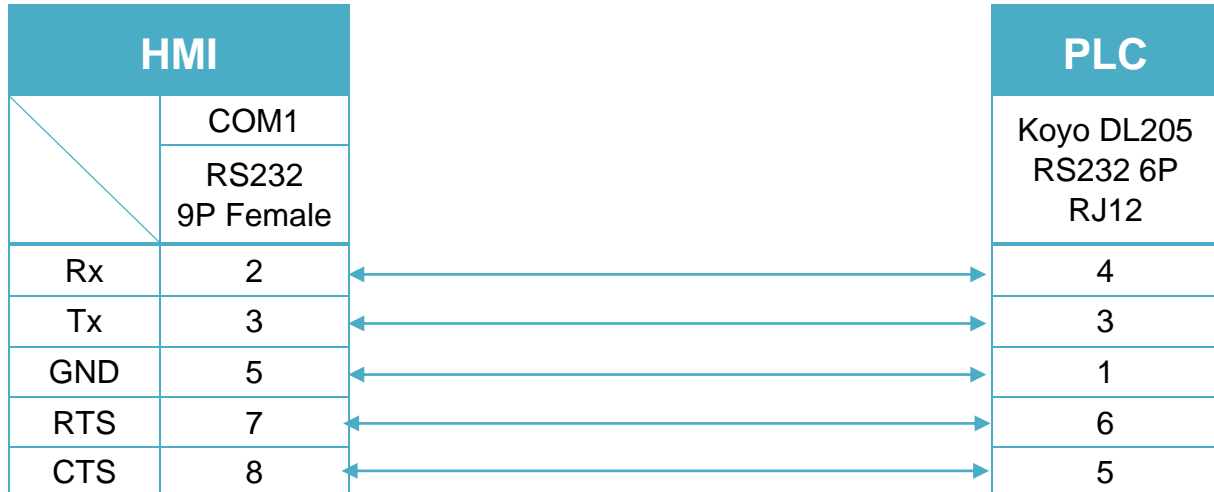


Diagram 3

cMT Series *cMT-SVR*

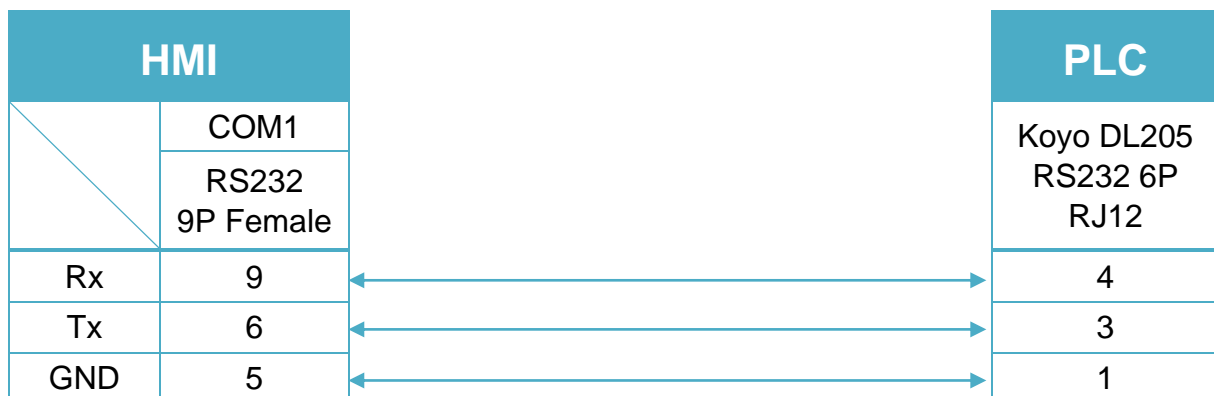
mTV *mTV*



Diagram 4

MT-iE *MT8050iE*

MT-iP *MT6051iP / MT6071iP / MT8071iP*



KOYO Do-more (Ethernet)

Supported Series: Do-more H2 Series PLC Ethernet port

Website: <http://www.automationdirect.com>

HMI Setting:

Parameters	Recommended	Options	Notes
PLC type	KOYO Do-more (Ethernet)		
PLC I/F	Ethernet		USE UDP
Port no.	28784		
PLC sta. no.	No need to set station no.		

PLC Setting:

Serial Port Mode	Do-more programming
------------------	---------------------

Device Address:

Bit/Word	Device type	Format	Range	Memo
B	ST	DDDD	0 ~ 1023	
B	X	DDDDD	0 ~ 65535	
B	Y	DDDDD	0 ~ 65535	
B	C	DDDDD	0 ~ 65535	
B	MI	DDDDD	0 ~ 65535	
B	MC	DDDDD	0 ~ 65535	
B	T.Done	DDDDD	0 ~ 32766	Read only
B	CT.Done	DDDDD	0 ~ 32766	Read only
B	DLX	OOOOOO	0 ~ 177777	
B	DLY	OOOOOO	0 ~ 177777	
B	DLC	OOOOOO	0 ~ 177777	
W	DLV	OOOOOO	0 ~ 177777	
W	SDT	D.D	0 ~ 7.6	*Note 1
W	WX	DDDDD	0 ~ 65535	
W	WY	DDDDD	0 ~ 65535	
W	V	DDDDD	0 ~ 65535	
W	N	DDDDD	0 ~ 65535	
W	SS	DDDD.DD	0 ~ 3854.34	Read only *Note 2

Bit/Word	Device type	Format	Range	Memo
W	SL	DDDD.DDD	0 ~ 1007.130	Read only *Note 2
W	UDT	DDDDD.D	0 ~ 32767.6	*Note 1
W	PL	DDD	0 ~ 255	
W	MIR	DDDDD	0 ~ 65535	
W	MHR	DDDDD	0 ~ 65535	
W	DST	DDD	0 ~ 511	
W	D	DDDDD	0 ~ 65534	
W	R	DDDDD	0 ~ 65534	Real Number (float)
W	T.ACC	DDDDD	0 ~ 32766	
W	CT.ACC	DDDDD	0 ~ 32766	

*Note 1 : SDT , UDT: xxx.0 = Year, xxx.1 = Month, xxx.2 = Day, xxx.3 = DayOfWeek,
xxx.4 = Hour, xxx.5 = Minute, xxx.6 = Second.

*Note 2 : SS , SL: xxx.0 = MaxLen, xxx.1 = Length, xxx.2 ~ 34 = String(SS)
xxx.2 ~ 130 =String (SL)

Wiring Diagram:

Diagram 1

Ethernet cable:



KOYO Ethernet

Supported Series: KOYO DirectLogic series, model H0-ECOM100, H2-ECOM100.

Website: <http://www.automationdirect.com>

HMI Setting:

Parameters	Recommended	Options	Notes
PLC type	KOYO Ethernet		
PLC I/F	Ethernet		UDP/IP
Port no.	28784		
PLC sta. no.	No need to set station no.	0	

Device Address:

Bit/Word	Device type	Format	Range	Memo
B	GX	OOOO	0 ~ 3777	Global I/O
B	X	OOOO	0 ~ 1777	Real Word Inputs
B	SP	OOOO	0 ~ 1777	Special Purpose Relays
B	GY	OOOO	0 ~ 3777	More Global I/O
B	Y	OOOO	0 ~ 1777	Real Word Outputs
B	C	OOOO	0 ~ 3777	Control Relays
B	S	OOOO	0 ~ 1777	Stage Status Bits
B	T	OOO	0 ~ 377	Timer Status Bits
B	CT	OOO	0 ~ 377	Counter Status Bits
W	V	OOOOO	0 ~ 41237	V-memory
W	CCM_32	HHH	1 ~ 200	GX, X, SP
W	CCM_33	HHH	1 ~ 340	GY, Y, C, S, T, CT
W	CCM_31	HHHH	1 ~ 42a0	V

ddd:Decimal, hhh:Hexadecimal, ooo:Octal

The mapping of CCM32, CCM33, and CCM31 with other addresses.

Device type	Range	Device type	Range
CCM_31	1~42A0	V	0~41237
CCM_32	1~FF	GX	0~3777
CCM_32	101~17F	X	0~1777
CCM_32	181~1FF	SP	0~1777
CCM_33	1~FF	GY	0~3777
CCM_33	101~17F	Y	0~1777
CCM_33	181~27F	C	0~3777
CCM_33	281~2FF	S	0~1777
CCM_33	301~31F	T	0~377
CCM_33	321~33F	CT	0~377

Wiring Diagram:

Diagram 1

Ethernet cable:



KOYO NK1

Supported Series: KOYO NK1 Series

Website: <http://www.automationdirect.com>

HMI Setting:

Parameters	Recommended	Options	Notes
PLC type	KOYO NK1		
PLC I/F	RS232		
Baud rate	115200		
Data bits	8		
Parity	None		
Stop bits	1		
PLC sta. no.	1		

Dvice Address:

Bit/Word	Device type	Format	Range	Memo
B	I	0000	0 ~ 1777	
B	Q	0000	0 ~ 1777	
B	M	0000	0 ~ 3777	
B	C	000	0 ~ 777	
B	T	000	0 ~ 777	
B	S	0000	0 ~ 1777	
B	SP	0000	0 ~ 1777	
B	GI	0000	0 ~ 3777	
B	GQ	0000	0 ~ 3777	
B	R	00000	0 ~ 41277	
B	Timer	000	0 ~ 777	
W	Counter	000	0 ~ 777	

Wiring Diagram:

Diagram 1

cMT Series	<i>cMT3151</i>
eMT Series	<i>eMT3070 / eMT3105 / eMT3120 / eMT3150</i>
MT-iE	<i>MT8073iE / MT8102iE</i>
MT-XE	<i>MT8092XE</i>
MT-iP	<i>MT6103iP</i>



Diagram 2

MT-iE	<i>MT8070iE / MT6070iE / MT8100iE / MT8121iE / MT8150iE / MT8071iE / MT6071iE / MT8072iE / MT6072iE / MT8073iE / MT8101iE / MT8102iE / MT8103iE</i>
MT-XE	<i>MT8121XE / MT8150XE / MT8090XE /</i>

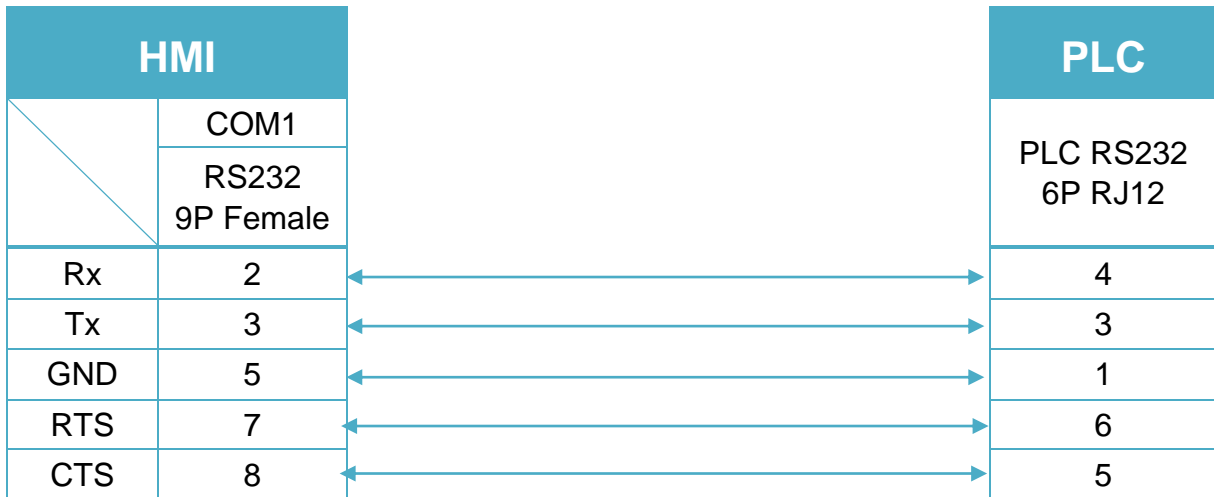


Diagram 3

cMT Series	<i>cMT-SVR</i>
mTV	<i>mTV</i>

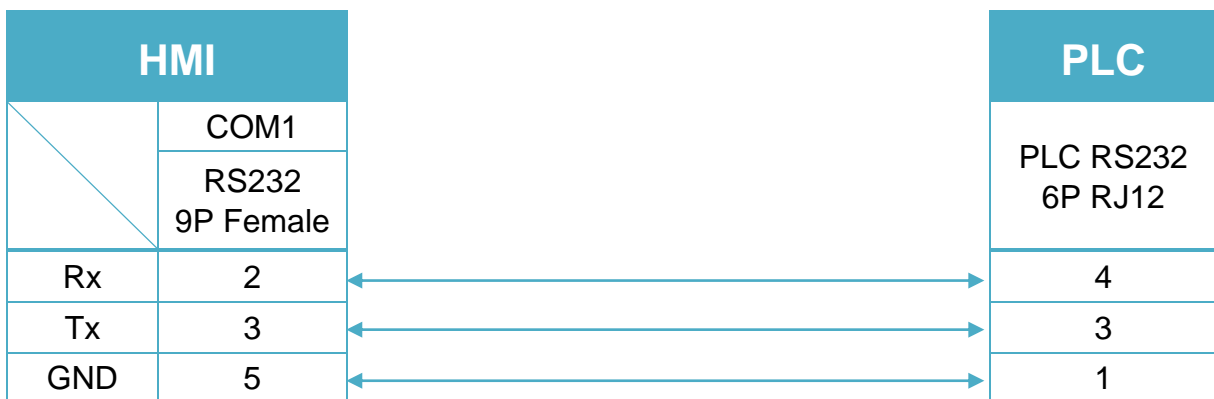
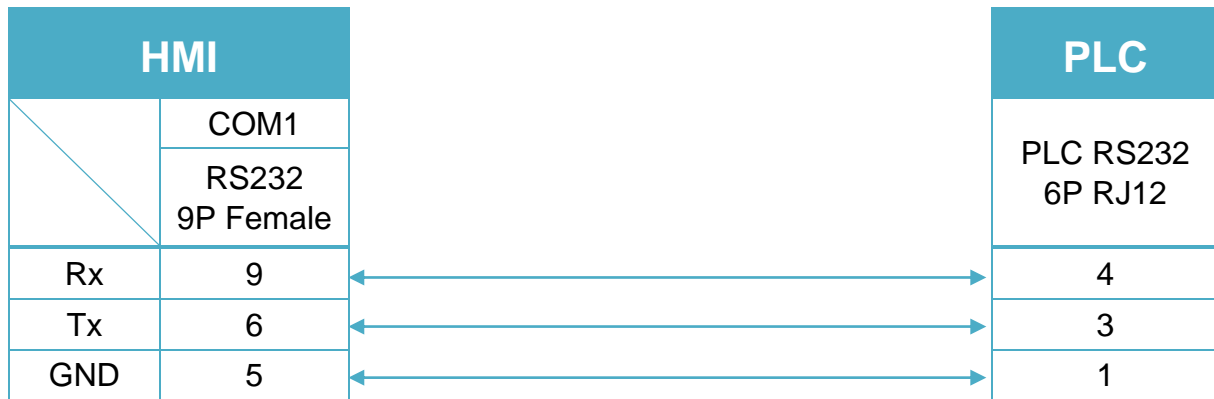


Diagram 4

MT-iE
MT8050iE
MT-iP
MT6051iP / MT6071iP / MT8071iP


KW ProConOS

Supported Series: KW ProConOS

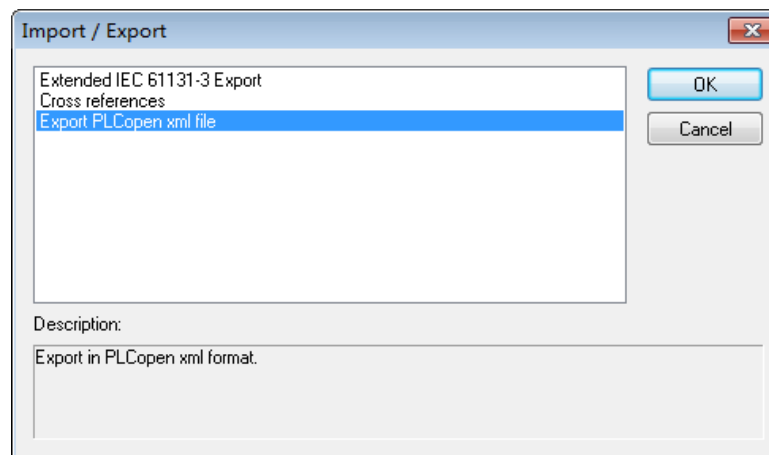
Website: <https://www.phoenixcontact.com/online/portal/pc>

HMI Setting:

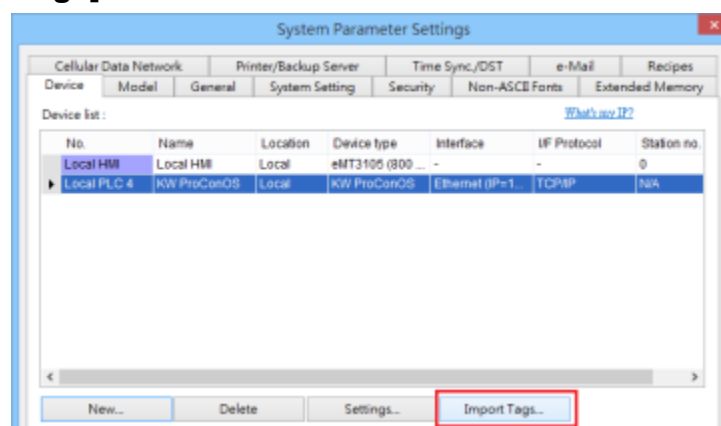
Parameters	Recommended	Options	Notes
PLC type	KW ProConOS		
PLC I/F	Ethernet		
Port no.	41101		

Import Tags:

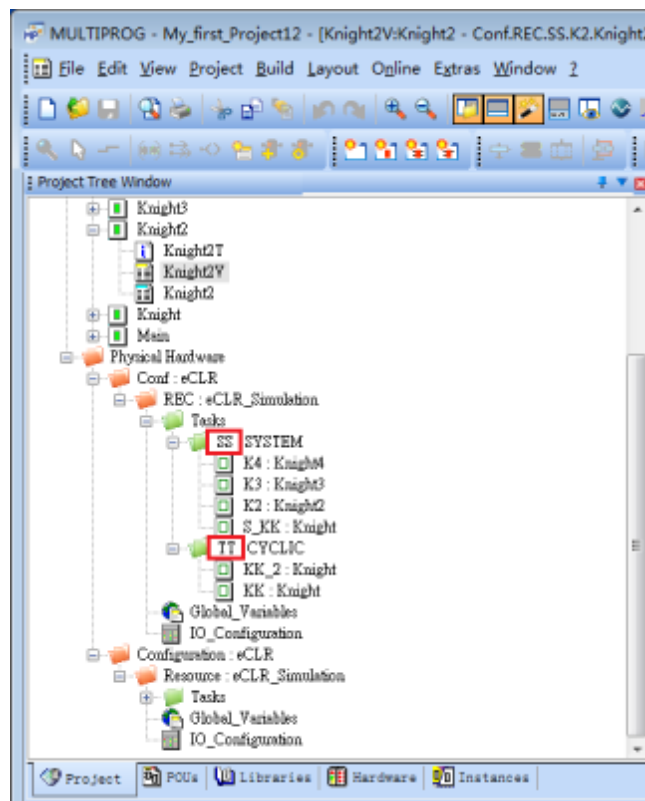
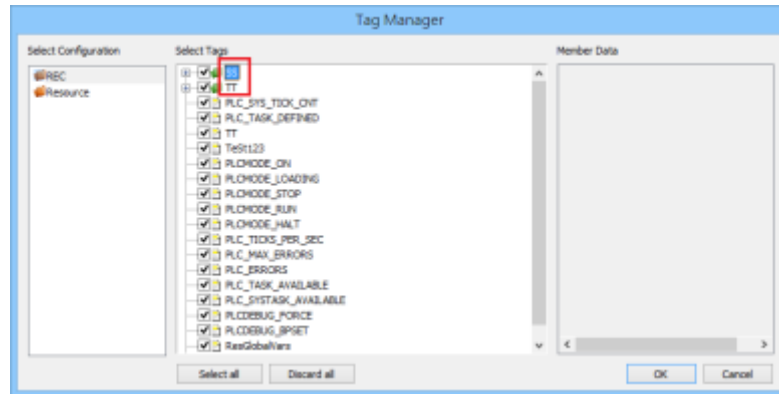
1. **Export tags:** Launch **MULTIPROG** software, select **File -> Export -> Export PLCopen xml file**.



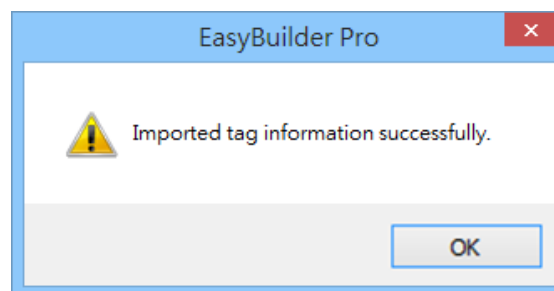
2. Launch **EasyBuilder Pro**, select **KW ProConOS** driver, set communication parameters, and then click **[Import Tags]**.



3. Select the imported .xml file, select the tags and then enter **task name** manually.
 Entering incorrect name can result in communication failure.



4. Click OK, the “Import tag information successfully.” message shows.



Support Device Type:

Data type	EasyBuilder data format	Memo
Bool	bit	
Byte	16-bit BCD, Hex, Binary, Unsigned	8-bit
SInt	16-bit BCD, Hex, Binary, Signed	8-bit
USInt	16-bit BCD, Hex, Binary, Unsigned	8-bit
Word	16-bit BCD, Hex, Binary, Unsigned	16-bit
Int	16-bit BCD, Hex, Binary, Signed	16-bit
UInt	16-bit BCD, Hex, Binary, Unsigned	16-bit
DWord	32-bit BCD, Hex, Binary, Unsigned	32-bit
DInt	32-bit BCD, Hex, Binary, Signed	32-bit
Real	32-bit Float	32-bit
UDInt	32-bit BCD, Hex, Binary, Unsigned	32-bit

Wiring Diagram:

Diagram 1

Ethernet cable:



Lenze

Supported Series: PLC Model No.: 9300/8200 series, and EPL10200

Pass-through 2102IB fieldbus module: RS485 (LECOM B)

Website: <http://www.lenze.de>

HMI Setting:

Parameters	Recommended	Options	Notes
PLC type	Lenze		
PLC I/F	RS232		
Baud rate	9600	9600, 19200	
Data bits	7	7,8	
Parity	None	Even, Odd, None	
Stop bits	1	1, 2	
PLC sta. no.	1	0-255	

PLC Setting:

Communication mode	Same as the MT500 setting
---------------------------	---------------------------

Device Address:

Bit/Word	Device type	Format	Range	Memo
B	CNB	DDDDdd	0 ~ 999915	Subcode not supported. Can only read/write CNI Word Type.
B	CB	DDDDddxx	0 ~ 81920015	Subcode supported. Can only read/write CI Word Type.
W	CI	DDDDdd	0 ~ 819200	Subcode supported. Integer
W	CD	DDDDdd	0 ~ 819200	Subcode supported. DWord
W	CF	DDDDdd	0 ~ 819200	Subcode supported. DWord (float point)
W	CNI	DDDD	0 ~ 9999	Subcode not supported. Integer
W	CND	DDDD	0 ~ 9999	Subcode not supported. DWord
W	CNF	DDDD	0 ~ 9999	Subcode not supported. DWord (float point)

Wiring Diagram:

Diagram 1

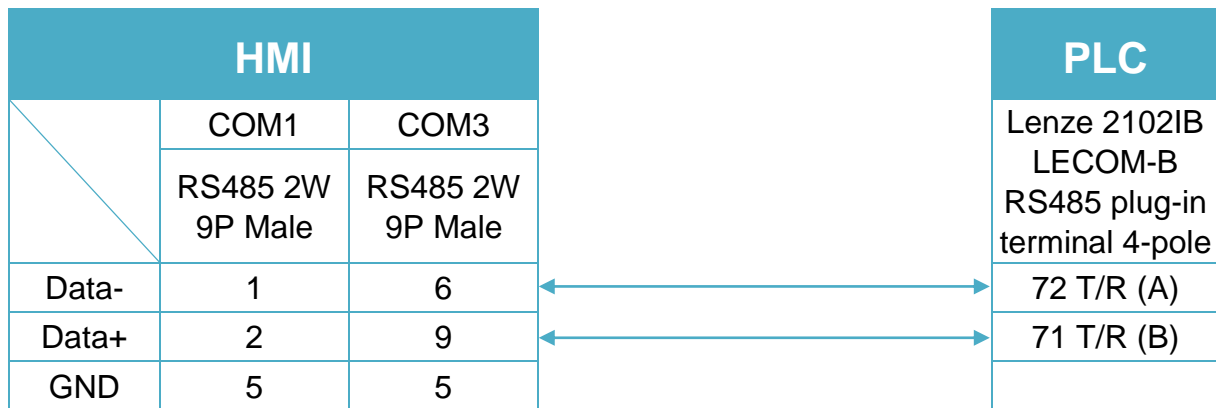
cMT Series
cMT3151
eMT Series
eMT3070 / eMT3105 / eMT3120 / eMT3150


Diagram 2

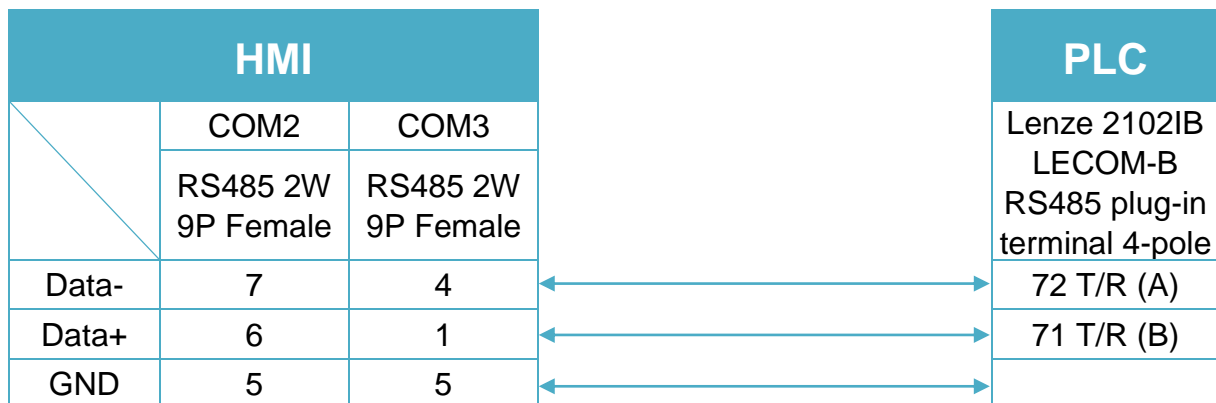
cMT Series
cMT-SVR
mTV
mTV


Diagram 3

MT-iE *MT8070iE / MT6070iE / MT8100iE / MT8121iE / MT8150iE*

MT-XE *MT8121XE / MT8150XE*

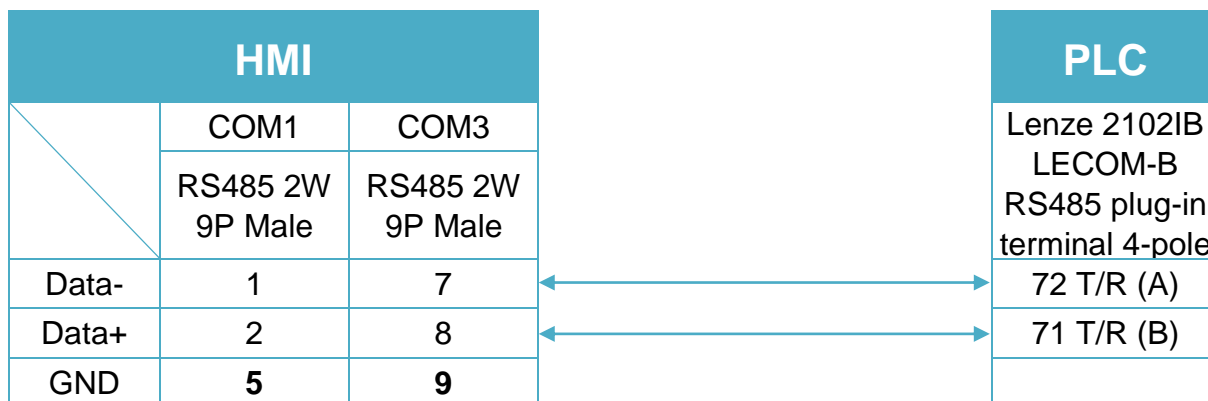


Diagram 4

MT-iE *MT8071iE / MT6071iE / MT8072iE / MT6072iE / MT8073iE /
MT8101iE / MT8102iE / MT8103iE*

MT-XE *MT8090XE / MT8092XE*

MT-iP *MT6103iP*

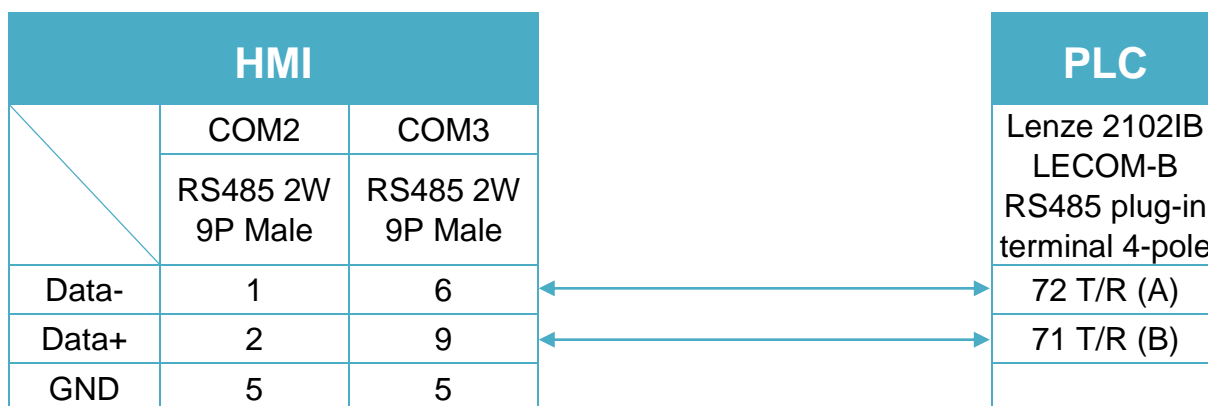


Diagram 5

MT-iE *MT8050iE*

MT-iP *MT6051iP*

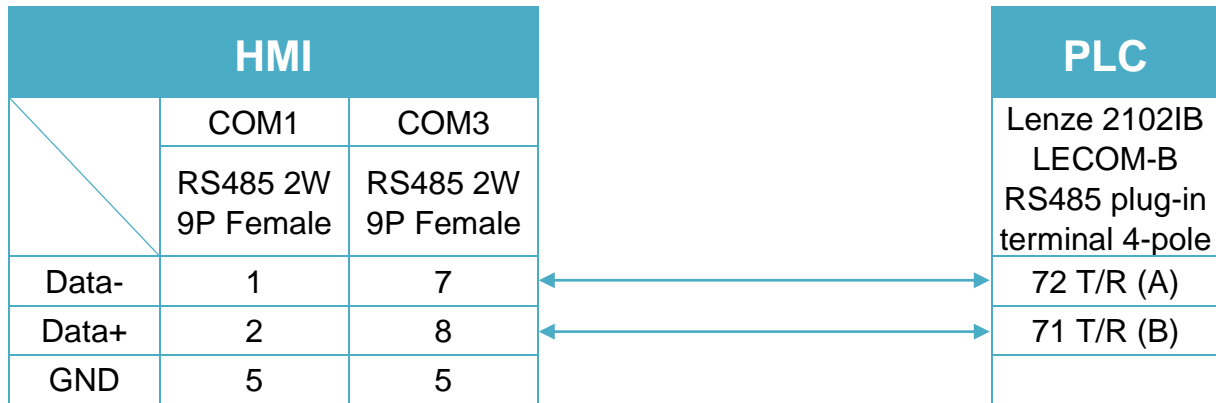
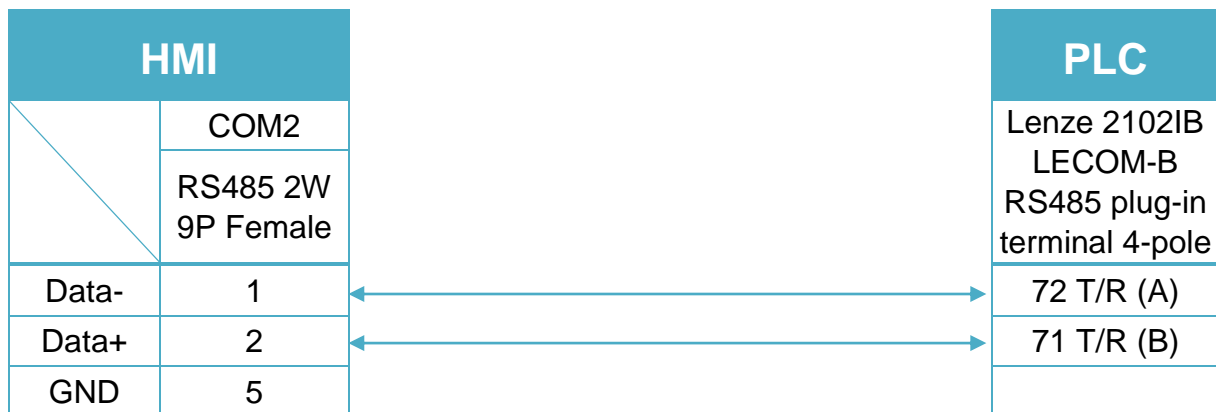


Diagram 6

MT-iP *MT6071iP / MT8071iP*



LingYan BMS

Website: http://www.lyeda.com/Project_file/bms01.htm

HMI Setting:

Parameters	Recommended	Options	Notes
PLC type	LingYan BMS		
PLC I/F	RS232		
Baud rate	9600		
Data bits	8		
Parity	None		
Stop bits	1		
PLC sta. no.	0		

Device Address:

Bit/Word	Device type	Format	Range	Memo
W	BMS	D	0	

Wiring Diagram:

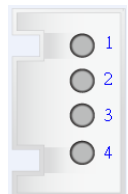
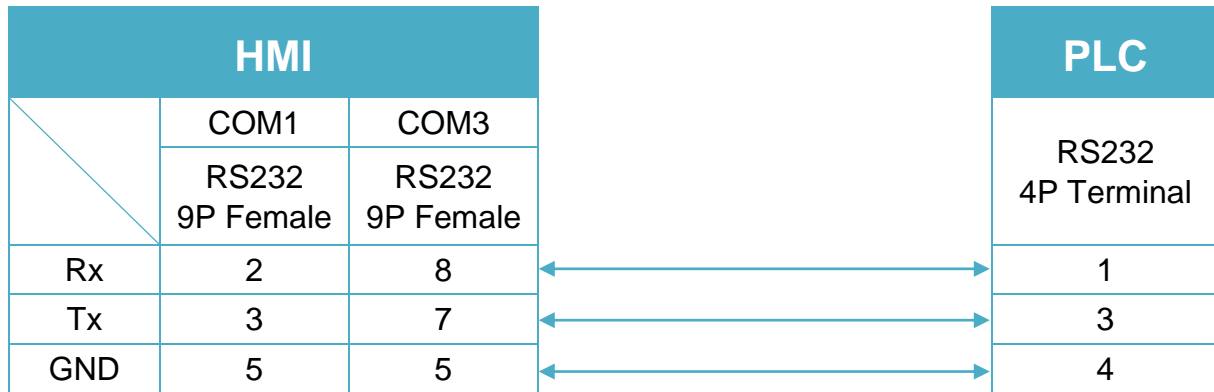


Diagram 1

cMT Series	<i>cMT3151</i>
eMT Series	<i>eMT3070 / eMT3105 / eMT3120 / eMT3150</i>
MT-iE	<i>MT8073iE / MT8102iE</i>
MT-XE	<i>MT8092XE</i>
MT-iP	<i>MT6103iP</i>


Diagram 2

cMT Series	cMT-SVR
mTV	mTV
MT-iE	MT8070iE / MT6070iE / MT8100iE / MT8121iE / MT8150iE / MT8071iE / MT6071iE / MT8072iE / MT6072iE / MT8073iE / MT8101iE / MT8102iE / MT8103iE
MT-XE	MT8121XE / MT8150XE / MT8090XE

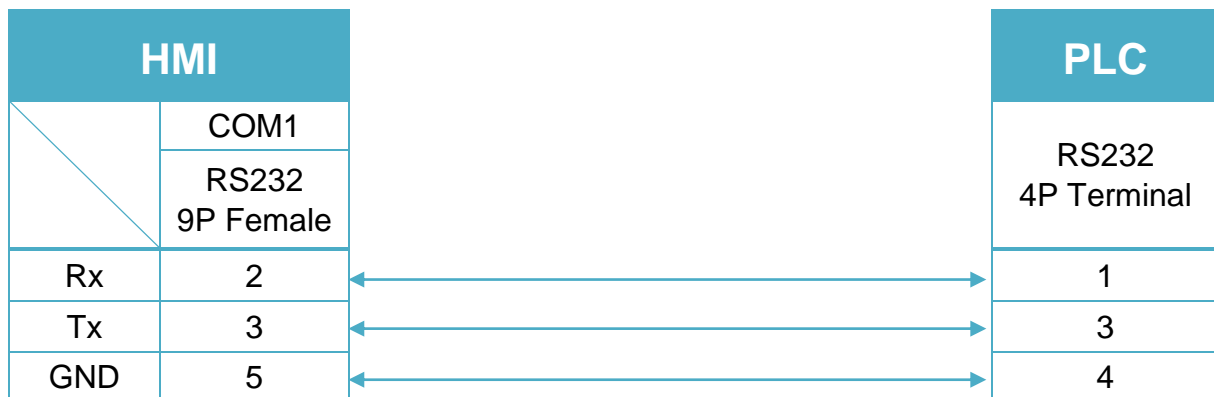
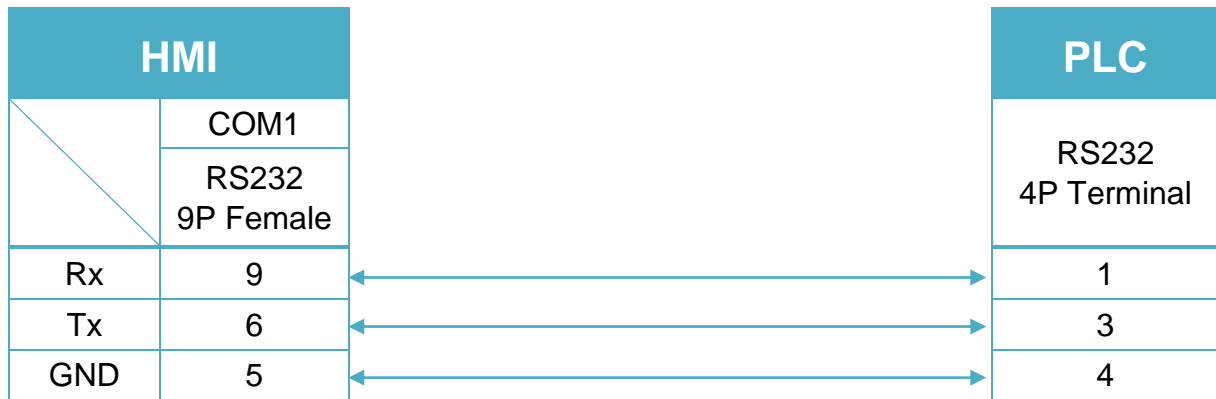


Diagram 3

MT-iE
MT8050iE
MT-iP
MT6051iP / MT6071iP / MT8071iP


LIYAN EX series

Supported Series: LIYAN PLC Ex/Ex1s/Ex1n/Ex2n series

Website: <http://www.liyanplc.com/>

HMI Setting:

Parameters	Recommended	Options	Notes
PLC type	Mitsubishi FX0s/FX0n/FX1s/FX1n/FX2		
PLC I/F	RS232	RS232	
Baud rate	9600	9600~115200	
Data bits	7	7,8	
Parity	Even	Even, Odd, None	
Stop bits	1	1,2	
PLC sta. no.	0	0-255	Must match the PLC port setting.

Device Address:

Bit/Word	Device type	Format	Range	Memo
B	X	ooo	0 ~ 377	Input Relay
B	Y	ooo	0 ~ 377	Output Relay
B	M	ddd	0 ~ 9999	Internal Bit Memory
B	T	ddd	0 ~ 255	Timer Bit Memory
B	C	ddd	0 ~ 255	Counter Bit Memory
W	TV	ddd	0 ~ 255	Timer Register
W	CV	ddd	0 ~ 199	Counter Register
W	D	ddd	0 ~ 9999	Data Register
W	CV2	ddd	200 ~ 255	Counter Register (Double Word)
W	SD	ddd	8000 ~ 9999	Special Data Register

Wiring Diagram:

The following is the view from the soldering point of a connector.



9P D-Sub to 8P Mini-DIN: Ex, Ex1s, Ex1n, Ex2n series

Diagram 1

cMT Series	cMT3151
eMT Series	eMT3070 / eMT3105 / eMT3120 / eMT3150
MT-iE	MT8073iE / MT8102iE
MT-XE	MT8092XE
MT-iP	MT6103iP

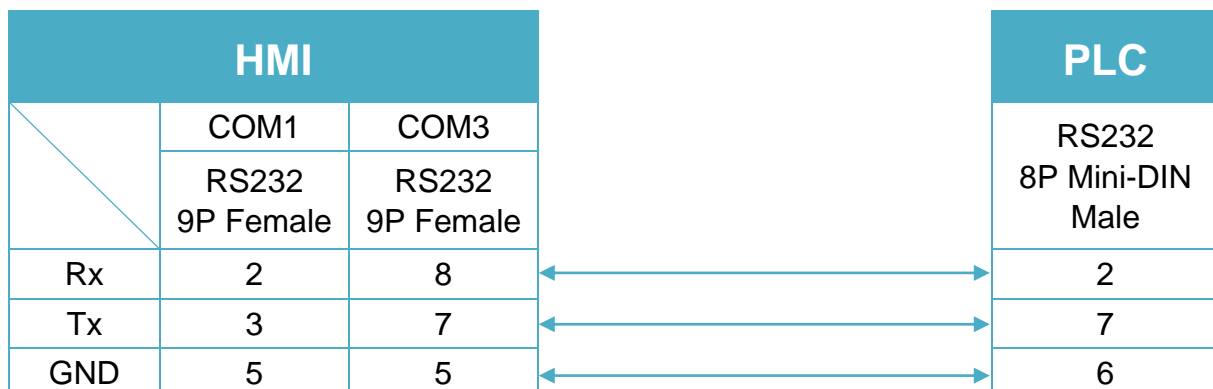


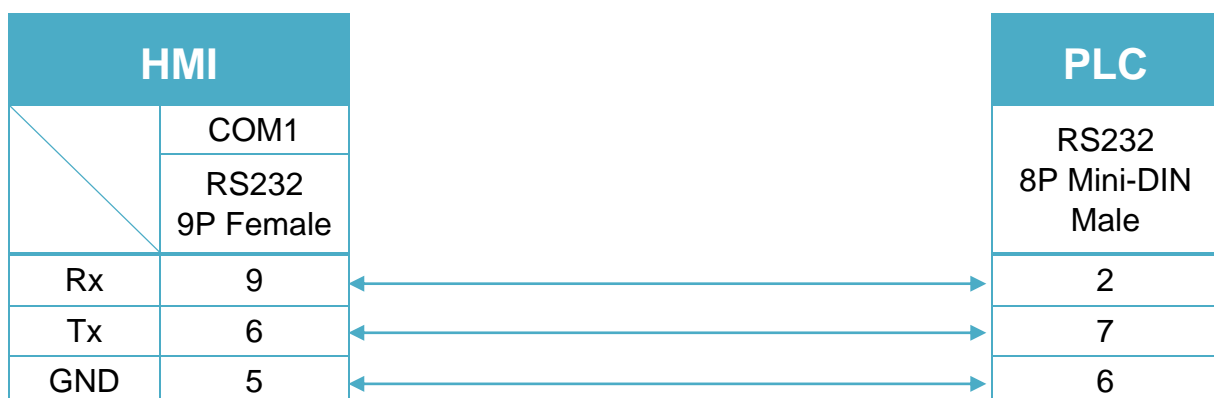
Diagram 2

cMT Series	cMT-SVR
mTV	mTV
MT-iE	MT8070iE / MT6070iE / MT8100iE / MT8121iE / MT8150iE / MT8071iE / MT6071iE / MT8072iE / MT6072iE / MT8073iE / MT8101iE / MT8102iE / MT8103iE
MT-XE	MT8121XE / MT8150XE / MT8090XE



Diagram 3

MT-iE	MT8050iE
MT-iP	MT6051iP / MT6071iP / MT8071iP



LoXin

Website: <http://www.loxin-china.com>

HMI Setting:

Parameters	Recommended	Options	Notes
PLC type	LoXin		
PLC I/F	RS-485 2W		
Baud rate	9600		
Data bits	8		
Parity	Odd		
Stop bits	1		
PLC sta. no.	0		

Device Address:

Bit/Word	Device type	Format	Range	Memo
W	Battery_Unit	D	0	
W	Insulator_Unit	D	0	
W	Switch_Unit	D	0	

Wiring Diagram:

Diagram 1

cMT Series

cMT3151

eMT Series

eMT3070 / eMT3105 / eMT3120 / eMT3150

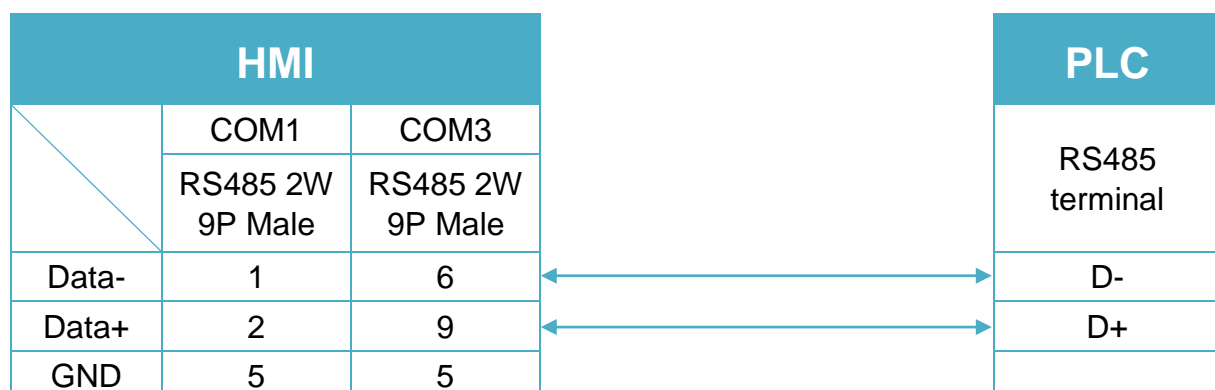


Diagram 2

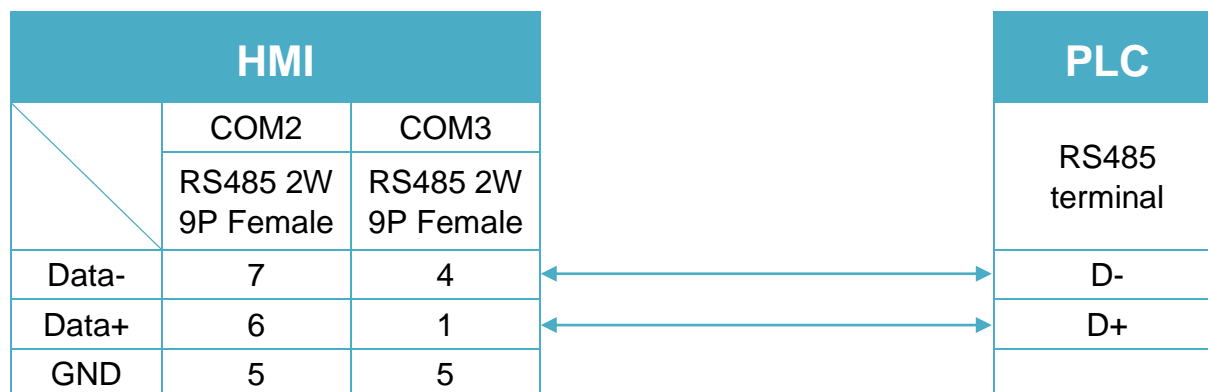
cMT Series
cMT-SVR
mTV
mTV


Diagram 3

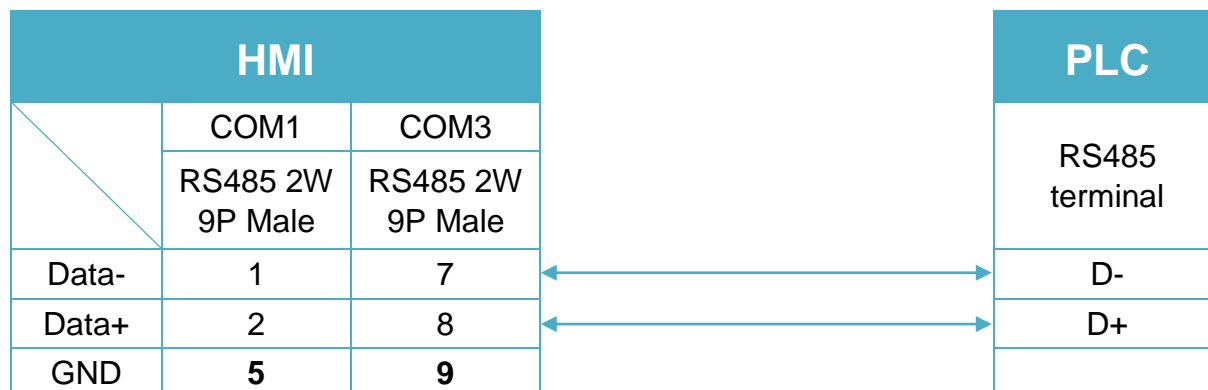
MT-iE
MT8070iE / MT6070iE / MT8100iE / MT8121iE / MT8150iE
MT-XE
MT8121XE / MT8150XE


Diagram 4

MT-iE	<i>MT8071iE / MT6071iE / MT8072iE / MT6072iE / MT8073iE / MT8101iE / MT8102iE / MT8103iE</i>
MT-XE	<i>MT8090XE / MT8092XE</i>
MT-iP	<i>MT6103iP</i>

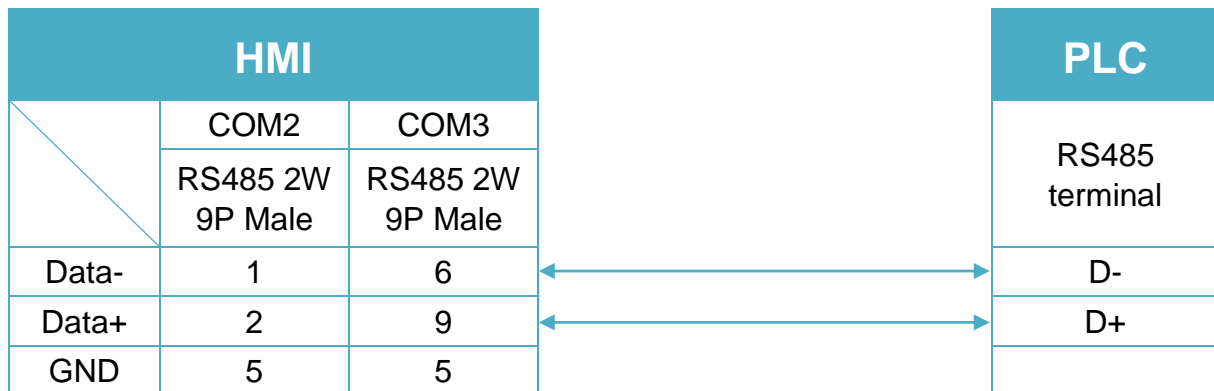


Diagram 5

MT-iE	<i>MT8050iE</i>
MT-iP	<i>MT6051iP</i>

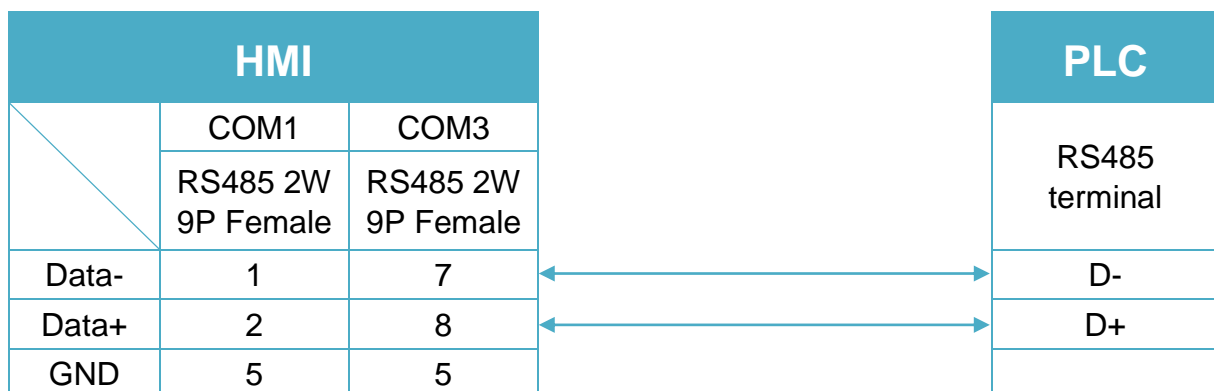
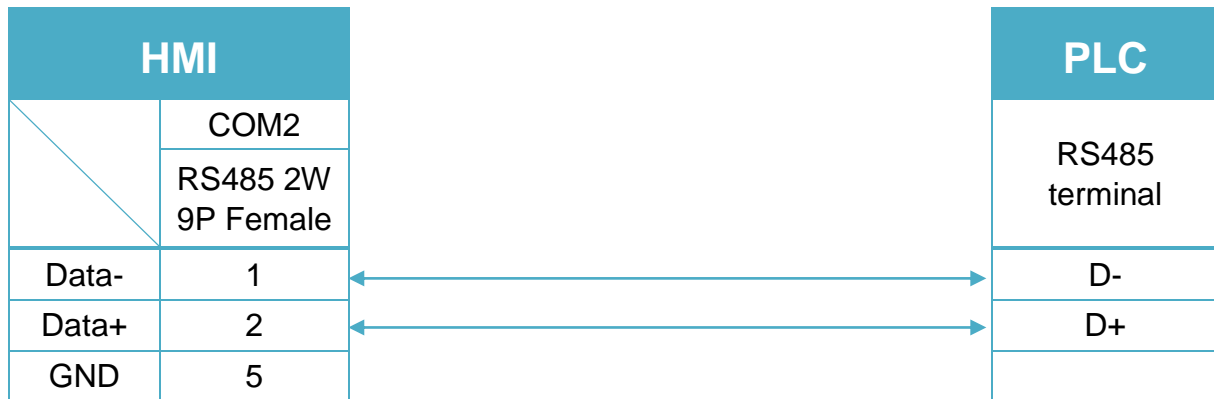


Diagram 6

MT-iP
MT6071iP / MT8071iP


LS GLOFA Cnet

Supported Series: LS GLOFA GM6/GM7 CPU port. G7L-CUEB / G6L-CUEB / G4L-CUEA / G3L-CUEA Cnet module

Website: <http://www.lgjs.com/>

HMI Setting:

Parameters	Recommended	Options	Notes
PLC type	LS GLOFA Cnet		
PLC I/F	RS232	RS232/RS485 2W/4W	
Baud rate	9600	9600~115200	
Data bits	8	7, 8	
Parity	None	Even, Odd, None	
Stop bits	1	1	
PLC sta. no.	0	0~31	

PLC Setting:

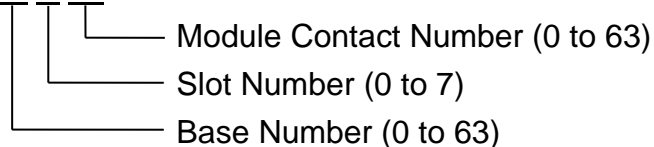
Communication mode	9600,N,8,1 (default), Cnet protocol
Communication module	Applicable mode: 1 dedicated communication

Device Address:

Bit/Word	Device type	Format	Range	Memo
B	MX	DDDDD	0 ~ 32767	Internal Relay
B	IX	ddDdd	0 ~ 63763	Input
B	QX	ddDdd	0 ~ 63763	Output
W	MW	DDDDD	0 ~ 32767	Data Register
DW	MD	DDDDD	0 ~ 16383	Double Word

Device explanation:

IX and QX format: dd D dd



Wiring Diagram:

9P D-Sub to 9P D-Sub (Diagram 1 ~ Diagram 3)

Diagram 1

cMT Series	<i>cMT3151</i>
eMT Series	<i>eMT3070 / eMT3105 / eMT3120 / eMT3150</i>
MT-iE	<i>MT8073iE / MT8102iE</i>
MT-XE	<i>MT8092XE</i>
MT-iP	<i>MT6103iP</i>

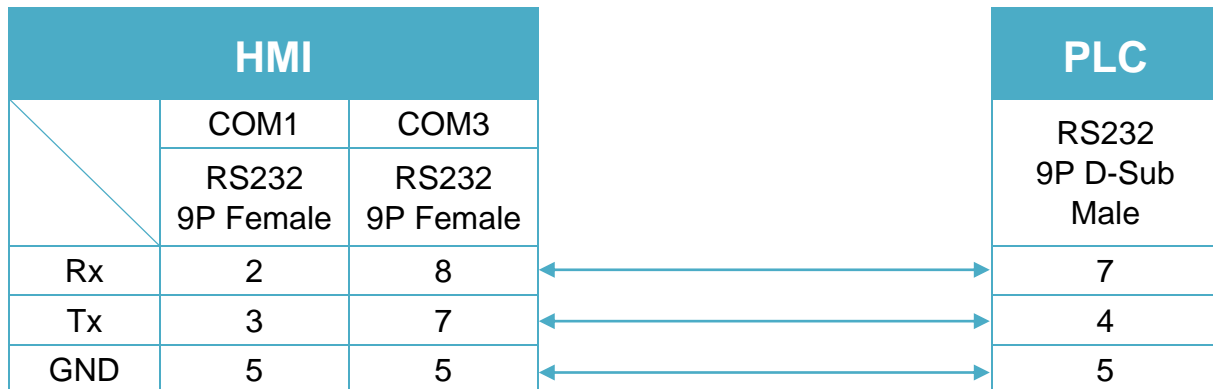


Diagram 2

cMT Series	<i>cMT-SVR</i>
mTV	<i>mTV</i>
MT-iE	<i>MT8070iE / MT6070iE / MT8100iE / MT8121iE / MT8150iE / MT8071iE / MT6071iE / MT8072iE / MT6072iE / MT8073iE / MT8101iE / MT8102iE / MT8103iE</i>
MT-XE	<i>MT8121XE / MT8150XE / MT8090XE</i>


Diagram 3

MT-iE *MT8050iE*

MT-iP *MT6051iP / MT6071iP / MT8071iP*



9P D-Sub to 9P D-Sub: Communication Module (G7L-CUEB / G6L-CUEB / G4L-CUEA / G3L-CUEA Cnet RS232)

(Diagram 4 ~ Diagram 6)

Diagram 4

cMT Series *cMT3151*

eMT Series *eMT3070/ eMT3105 / eMT3120 / eMT3150*

MT-iE *MT8073iE / MT8102iE*

MT-XE *MT8092XE*

MT-iP *MT6103iP*

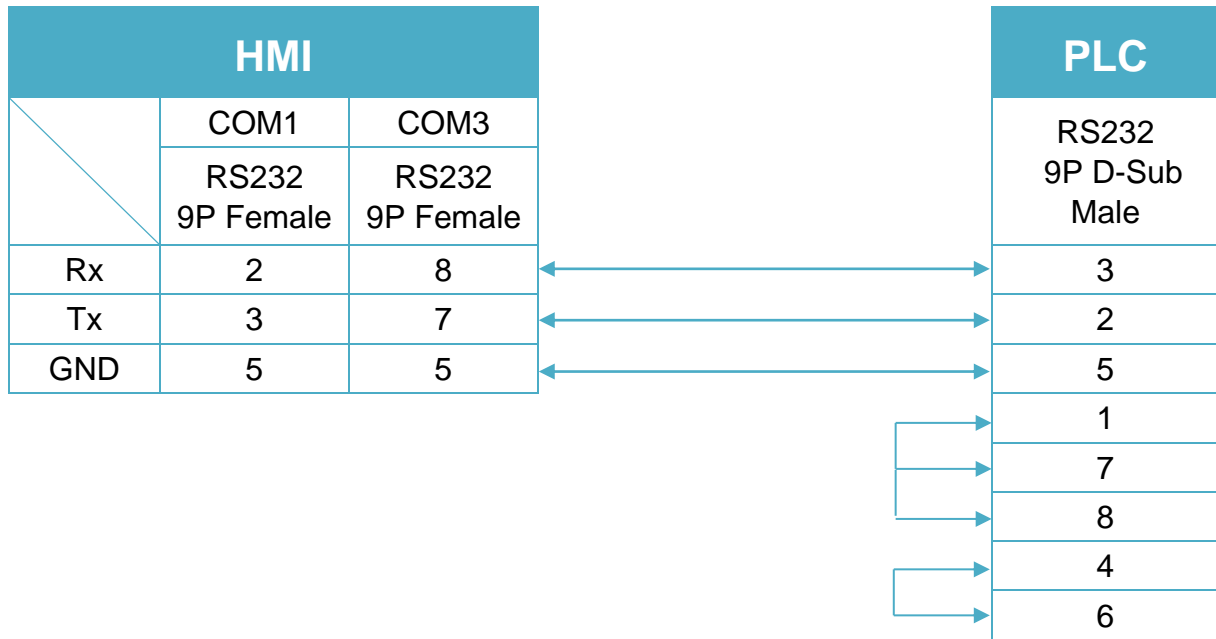
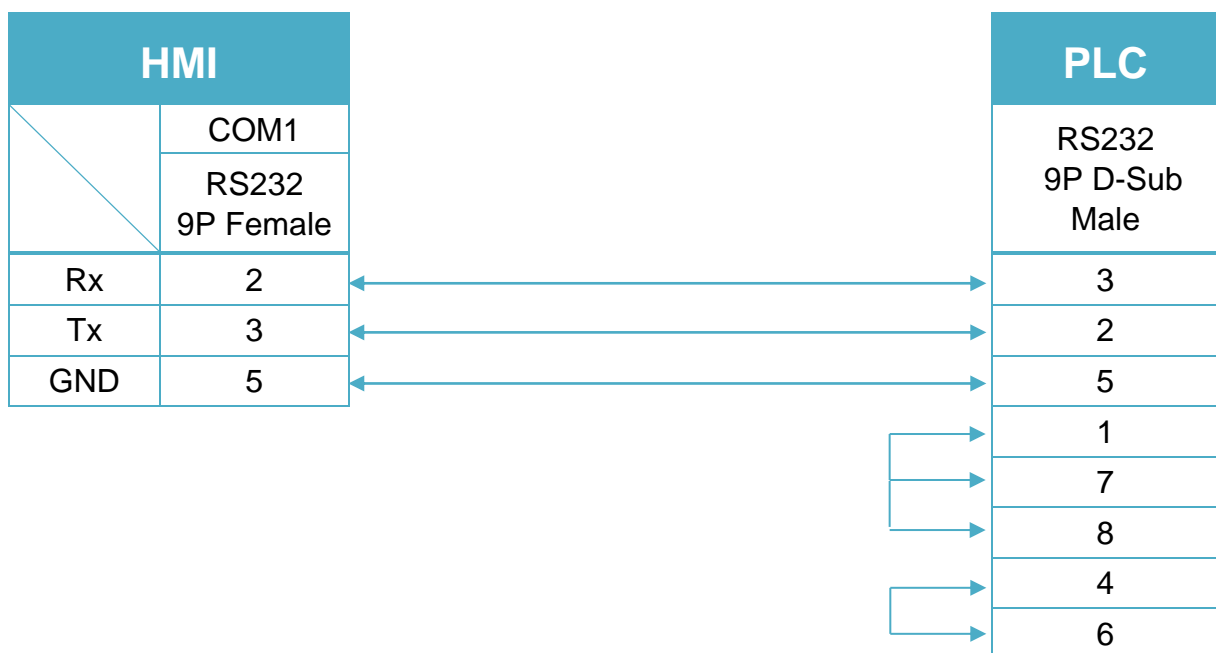
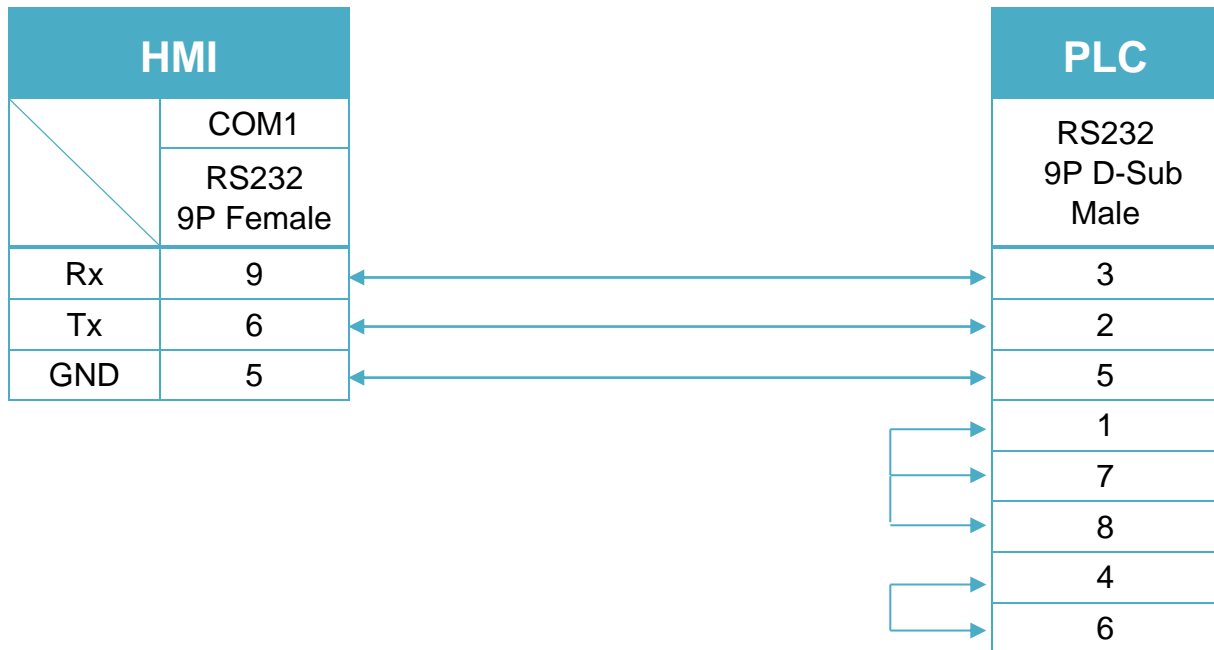

Diagram 5
cMT Series
cMT-SVR
mTV
mTV
MT-iE
***MT8070iE / MT6070iE / MT8100iE / MT8121iE / MT8150iE /
MT8071iE / MT6071iE / MT8072iE / MT6072iE / MT8073iE /
MT8101iE / MT8102iE / MT8103iE***
MT-XE
MT8121XE / MT8150XE / MT8090XE /


Diagram 6

MT-iE	MT8050iE
MT-iP	MT6051iP / MT6071iP / MT8071iP



Communication Module (G7L-CUEC / G6L-CUEC / G4L-CUEA / G3L-CUEA Cnet RS422)
(Diagram 7 ~ Diagram 10)

Diagram 7

cMT Series	cMT3151
eMT Series	eMT3070 / eMT3105 / eMT3120 / eMT3150
MT-iE	MT8070iE / MT6070iE / MT8100iE / MT8121iE / MT8150iE
MT-XE	MT8121XE / MT8150XE

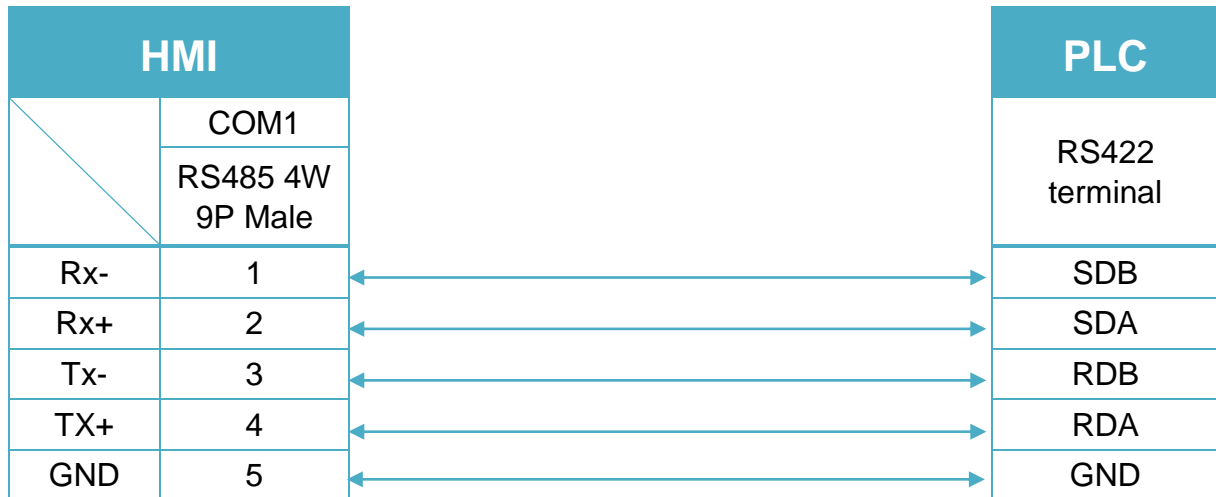


Diagram 8

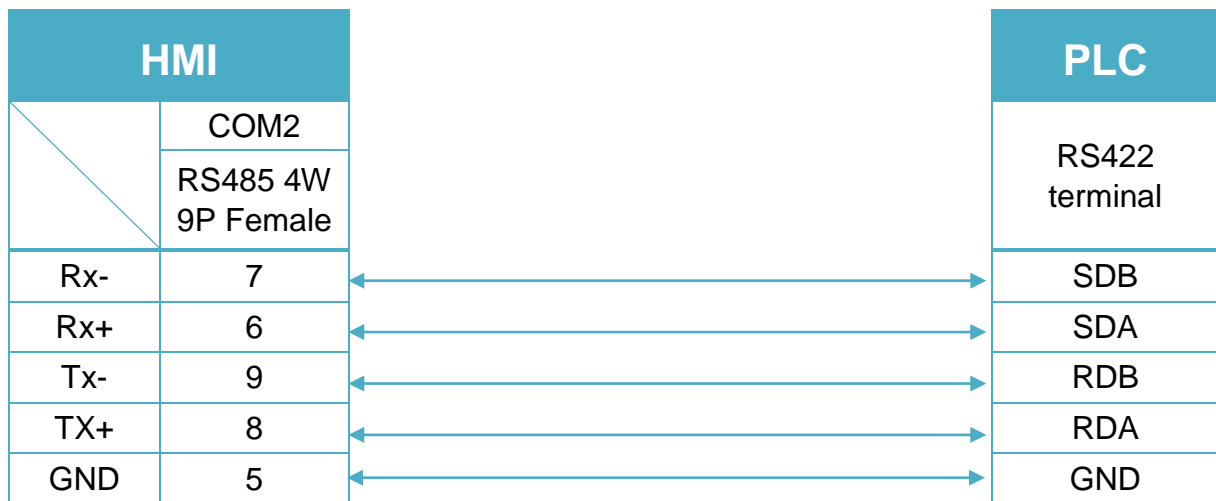
cMT Series
cMT-SVR
mTV
mTV


Diagram 9

MT-iE	<i>MT8071iE / MT6071iE / MT8072iE / MT6072iE / MT8073iE / MT8101iE / MT8102iE / MT8103iE</i>
MT-XE	<i>MT8090XE / MT8092XE</i>
MT-iP	<i>MT6071iP / MT8071iP / MT6103iP</i>

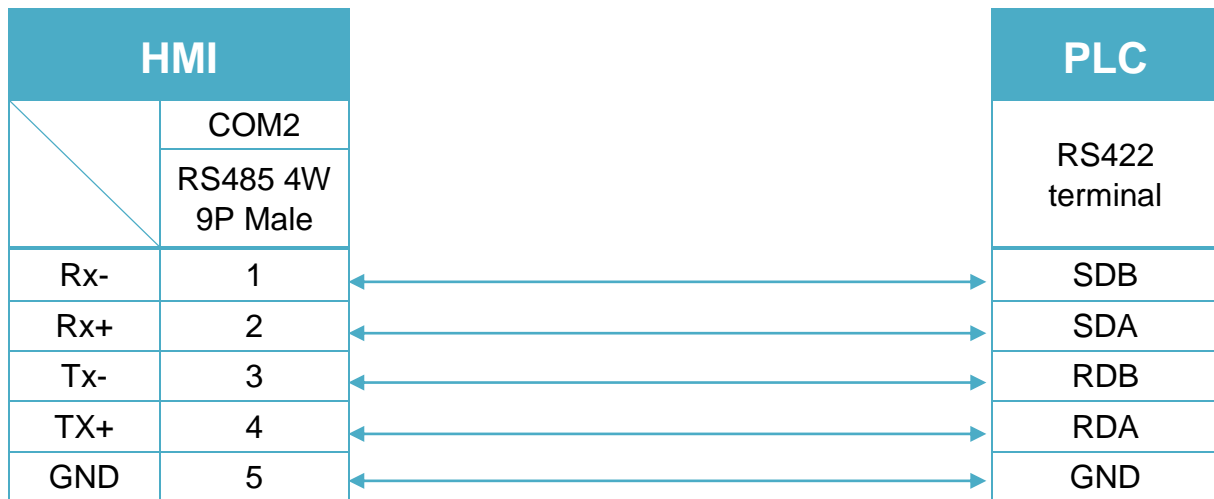
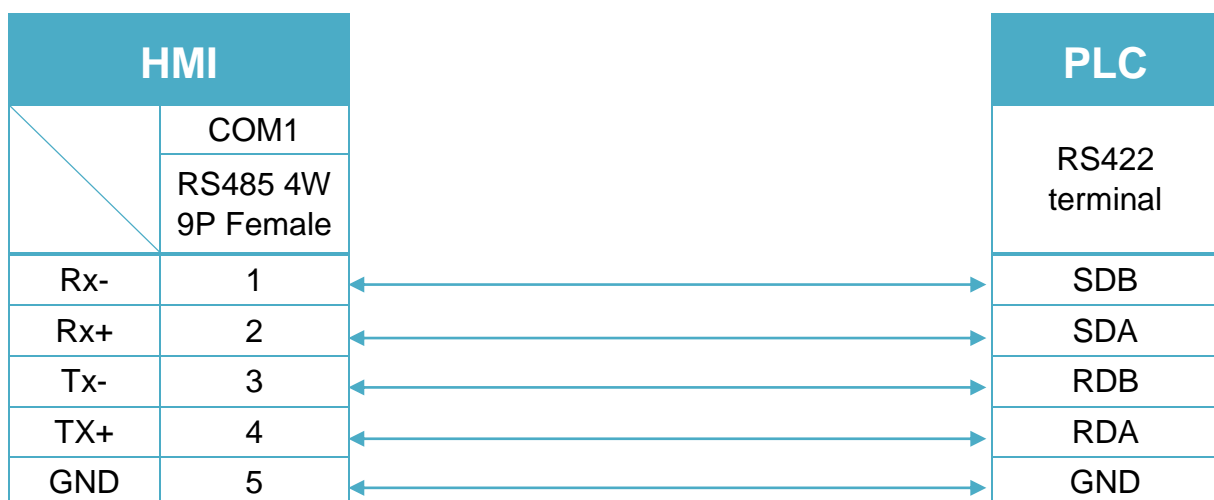


Diagram 10

MT-iE	<i>MT8050iE</i>
MT-iP	<i>MT6051iP</i>



LS GLOFA FEnet (Ethernet)

Website: <http://www.lqis.com/>

HMI Setting:

Parameters	Recommended	Options	Notes
PLC type	LS GLOFA FEnet (Ethernet)		
PLC I/F	Ethernet		
Port no.	2004		
PLC sta. no.	0	0~31	

Device Address:

Bit/Word	Device type	Format	Range	Memo
B	MX	DDDDDD	0 ~ 131056	Internal Relay
B	IX	ddDdd	0 ~ 63763	Input
B	QX	ddDdd	0 ~ 63763	Output
W	MW	DDDD	0 ~ 8191	Data Register
DW	MD	DDDD	0 ~ 4095	Double Word

Wiring Diagram:

Diagram 1

Ethernet cable:



LS GLOFA GM3467 (LOADER)

Supported Series: LS GLOFA series GM3, GM4, GM6, GM7 CPU port.

Website: <http://www.lqis.com/>

HMI Setting:

Parameters	Recommended	Options	Notes
PLC type	LS GLOFA GM3467 (LOADER)		
PLC I/F	RS232		
Baud rate	38400		
Data bits	8		
Parity	None		
Stop bits	1		
PLC sta. no.	1		

Device Address:

Bit/Word	Device type	Format	Range	Memo
B	MX	DDDDDD	0 ~ 524272	
B	IX	ddDdd	0 ~ 63763	00.0.0 ~ 63.7.63 (dd.D.dd)
B	QX	ddDdd	0 ~ 63763	00.0.0 ~ 63.7.63 (dd.D.dd)
W	IW	HHH	0 ~ 273	
W	QW	HHH	0 ~ 273	
W	MW	DDDDD	0 ~ 32767	
W	MD	DDDDD	0 ~ 16383	

Wiring Diagram:

LS GLOFA series:

Diagram 1

cMT Series	<i>cMT3151</i>
eMT Series	<i>eMT3070 / eMT3105 / eMT3120 / eMT3150</i>
MT-iE	<i>MT8073iE / MT8102iE</i>
MT-XE	<i>MT8092XE</i>
MT-iP	<i>MT6103iP</i>

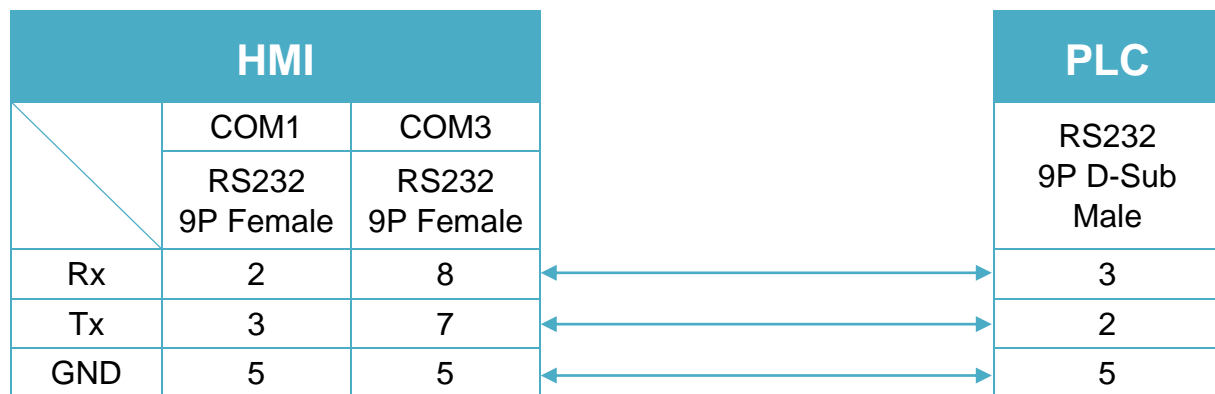


Diagram 2

cMT Series	cMT-SVR
mTV	mTV
MT-iE	MT8070iE / MT6070iE / MT8100iE / MT8121iE / MT8150iE / MT8071iE / MT6071iE / MT8072iE / MT6072iE / MT8073iE / MT8101iE / MT8102iE / MT8103iE
MT-XE	MT8121XE / MT8150XE / MT8090XE

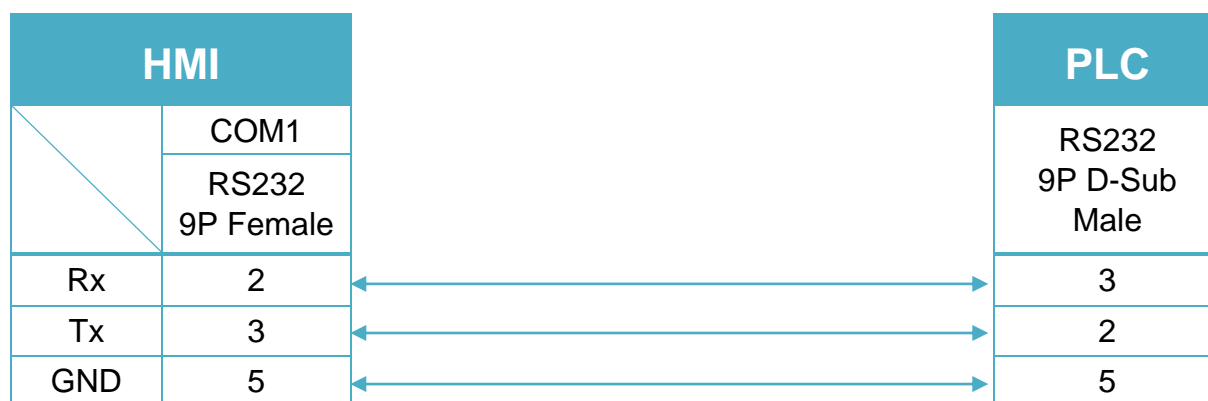
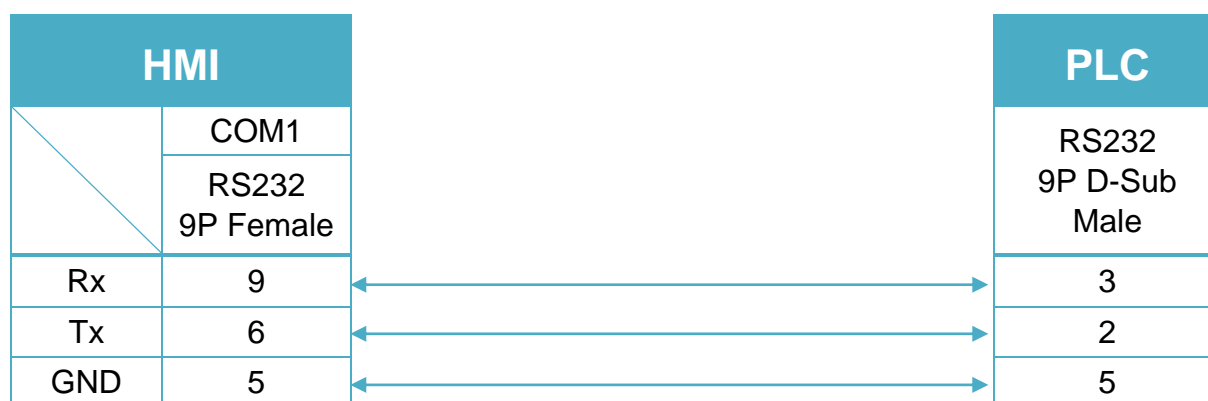


Diagram 3

MT-iE	MT8050iE
MT-iP	MT6051iP / MT6071iP / MT8071iP



LS MASTER-K Cnet

Supported Series: LS MASTER-K series: K80S, K200S, K300S, and K1000S

Website: <http://www.lgis.com/>

HMI Setting:

Parameters	Recommended	Options	Notes
PLC type	LS MASTER-K Cnet		
PLC I/F	RS232	RS232/RS485	
Baud rate	38400	9600, 19200, 38400	
Data bits	8	8	
Parity	None	Even, Odd, None	
Stop bits	1	1	
PLC sta. no.	0	0-31	

Online simulator	YES
-------------------------	-----

Device Address:

Bit/Word	Device type	Format	Range	Memo
B	PW_Bit	DDDh	0 ~ 255f	I/O Relay (P)
B	KW_Bit	DDDh	0 ~ 255f	Keep Relay (K)
B	MW_Bit	DDDh	0 ~ 255f	Auxiliary Relay (M)
B	LW_Bit	DDDh	0 ~ 255f	Link Relay (L)
B	FW_Bit	DDDh	0 ~ 255f	Special Relay (F)
B	TX	DDDh	0 ~ 255	
B	CX	DDDh	0 ~ 255	
B	DW_bit	DDDDh	0 ~ 9999f	D_bit
B	SX	DD.DD	0 ~ 99.99	
W	MW	DDD	0 ~ 255	Word type for M
W	LW	DDD	0 ~ 255	Word type for L
W	FW	DDD	0 ~ 255	Word type for F
W	PW	DD	0 ~ 63	
W	KW	DD	0 ~ 31	
W	TW	DDD	0 ~ 255	Timer Present Value
W	CW	DDD	0 ~ 255	Counter Present Value
W	DW	DDDD	0 ~ 9999	Data Register (D)

Wiring Diagram:

CPU Port Cnet I/F:

Diagram 1

cMT Series	<i>cMT3151</i>
eMT Series	<i>eMT3070 / eMT3105 / eMT3120 / eMT3150</i>
MT-iE	<i>MT8073iE / MT8102iE</i>
MT-XE	<i>MT8092XE</i>
MT-iP	<i>MT6103iP</i>

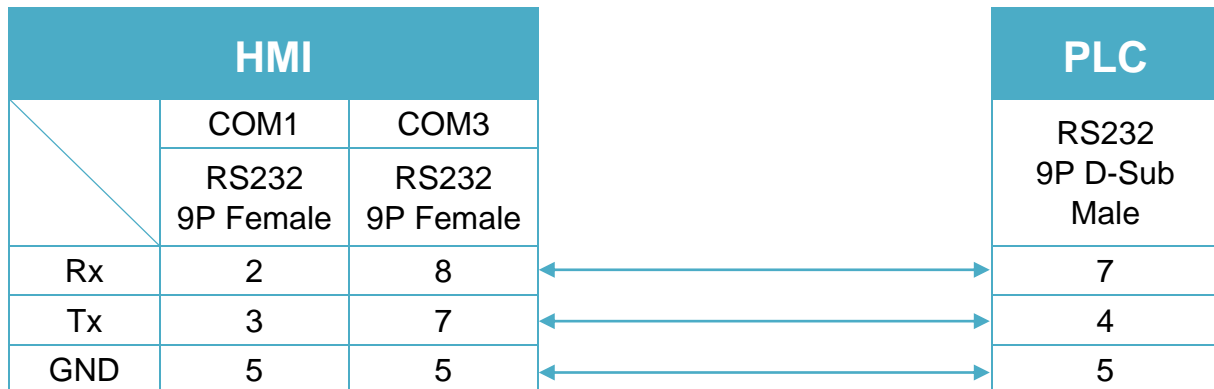


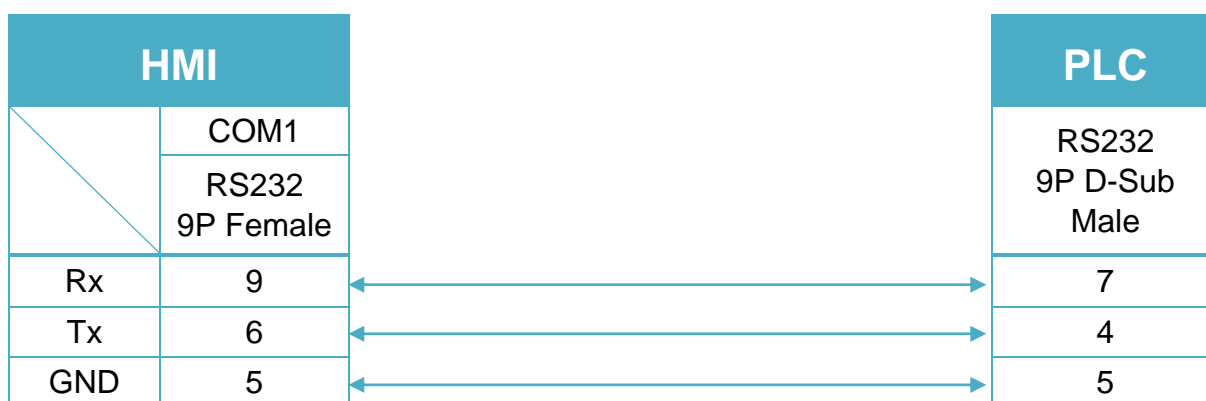
Diagram 2

cMT Series	cMT-SVR
mTV	mTV
MT-iE	MT8070iE / MT6070iE / MT8100iE / MT8121iE / MT8150iE / MT8071iE / MT6071iE / MT8072iE / MT6072iE / MT8073iE / MT8101iE / MT8102iE / MT8103iE
MT-XE	MT8121XE / MT8150XE / MT8090XE



Diagram 3

MT-iE	MT8050iE
MT-iP	MT6051iP / MT6071iP / MT8071iP



If connected with Cnet module, please refer to Cnet module document.

LS MASTER-K CPU Direct

Supported Series: LS MASTER-K series: K80S, K120S, K200S, K300S, K1000S, K7M.

Website: <http://www.lgjs.com/>

HMI Setting:

Parameters	Recommended	Options	Notes
PLC type	LG MASTER-K CPU Direct		
PLC I/F	RS232	RS232/RS485	
Baud rate	38400	9600, 19200, 38400	
Data bits	8	8	
Parity	None	Even, Odd, None	
Stop bits	1	1	
PLC sta. no.	0	0-31	

Online simulator	YES
------------------	-----

Device Address:

Bit/Word	Device type	Format	Range	Memo
B	PW_Bit	DDDh	0 ~ 255f	I/O Relay (P)
B	KW_Bit	DDDh	0 ~ 255f	Keep Relay (K)
B	MW_Bit	DDDh	0 ~ 255f	Auxiliary Relay (M)
B	LW_Bit	DDDh	0 ~ 255f	Link Relay (L)
B	FW_Bit	DDDh	0 ~ 255f	Special Relay (F)
B	TX	DDD	0 ~ 255	
B	CX	DDD	0 ~ 255	
B	SX	DD.DD	0 ~ 99.99	
B	DW_bit	DDDDh	0 ~ 9999f	D_bit
W	MW	DDD	0 ~ 255	Word type for M
W	LW	DDD	0 ~ 255	Word type for L
W	FW	DDD	0 ~ 255	Word type for F
W	PW	DD	0 ~ 63	
W	KW	DD	0 ~ 31	
W	TW	DDD	0 ~ 255	Timer Present Value
W	CW	DDD	0 ~ 255	Counter Present Value
W	DW	DDDD	0 ~ 9999	Data Register (D)

Wiring Diagram:

Diagram 1

cMT Series	<i>cMT3151</i>
eMT Series	<i>eMT3070 / eMT3105 / eMT3120 / eMT3150</i>
MT-iE	<i>MT8073iE / MT8102iE</i>
MT-XE	<i>MT8092XE</i>
MT-iP	<i>MT6103iP</i>



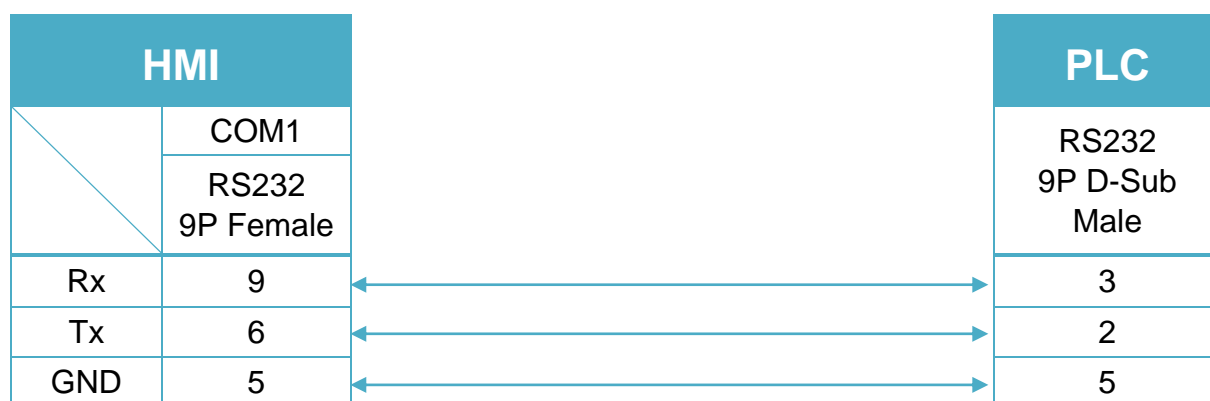
Diagram 2

cMT Series	cMT-SVR
mTV	mTV
MT-iE	MT8070iE / MT6070iE / MT8100iE / MT8121iE / MT8150iE / MT8071iE / MT6071iE / MT8072iE / MT6072iE / MT8073iE / MT8101iE / MT8102iE / MT8103iE
MT-XE	MT8121XE / MT8150XE / MT8090XE



Diagram 3

MT-iE	MT8050iE
MT-iP	MT6051iP / MT6071iP / MT8071iP



LS MASTER-K MODBUS RTU

Supported Series: LS MASTER-K MODBUS RTU

Website: <http://www.lqis.com/>

HMI Setting:

Parameters	Recommended	Options	Notes
PLC type	LS MASTER-K MODBUS RTU		
PLC I/F	RS485 2W		
Baud rate	9600		
Data bits	8	8	
Parity	Even	Even	
Stop bits	1	1	
PLC sta. no.	1		

Device Address:

Bit/Word	Device	Format	Range	Memo
B	PW_Bit	DDDDh	0 ~ 9999f	I/O Relay (P)
B	KW_Bit	DDDDh	0 ~ 9999f	Keep Relay (K)
B	MW_Bit	DDDDh	0 ~ 9999f	Auxiliary Relay (M)
B	LW_Bit	DDDDh	0 ~ 9999f	Link Relay (L)
B	FW_Bit	DDDDh	0 ~ 9999f	Special Relay (F)
B	DW_Bit	DDDDh	0 ~ 9999f	
W	MW	DDDD	0 ~ 9999	
W	LW	DDDD	0 ~ 9999	
W	FW	DDDD	0 ~ 9999	
W	TW	DDDD	0 ~ 9999	Timer (T)
W	CW	DDDD	0 ~ 9999	Counter (C)
W	SW	DDDD	0 ~ 9999	
W	DW	DDDD	0 ~ 9999	Data Register (D)
DW	TD	DDDD	0 ~ 9999	
DW	CD	DDDD	0 ~ 9999	
DW	SD	DDDD	0 ~ 9999	
DW	DD	DDDD	0 ~ 9999	

Wiring Diagram:

Diagram 1

cMT Series	<i>cMT3151</i>
eMT Series	<i>eMT3070 / eMT3105 / eMT3120 / eMT3150</i>
MT-iE	<i>MT8073iE / MT8102iE</i>
MT-XE	<i>MT8092XE</i>
MT-iP	<i>MT6103iP</i>

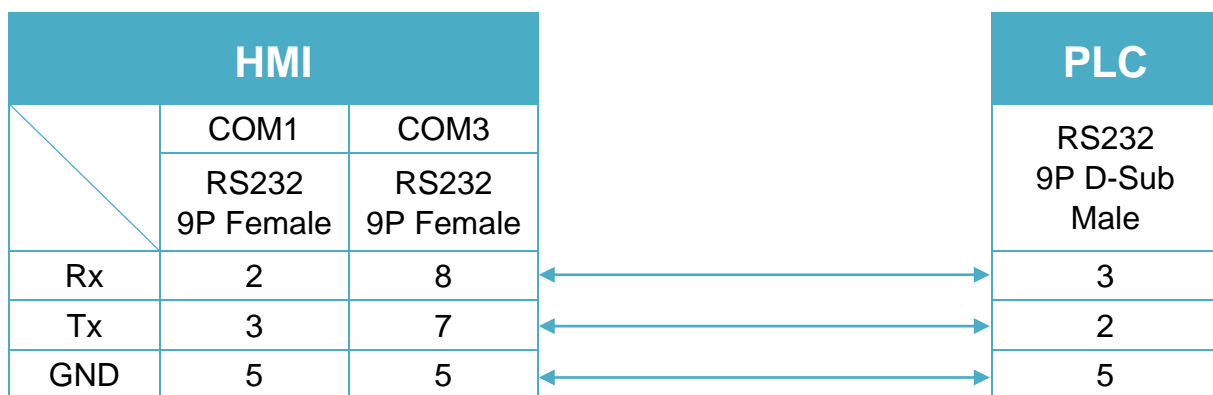


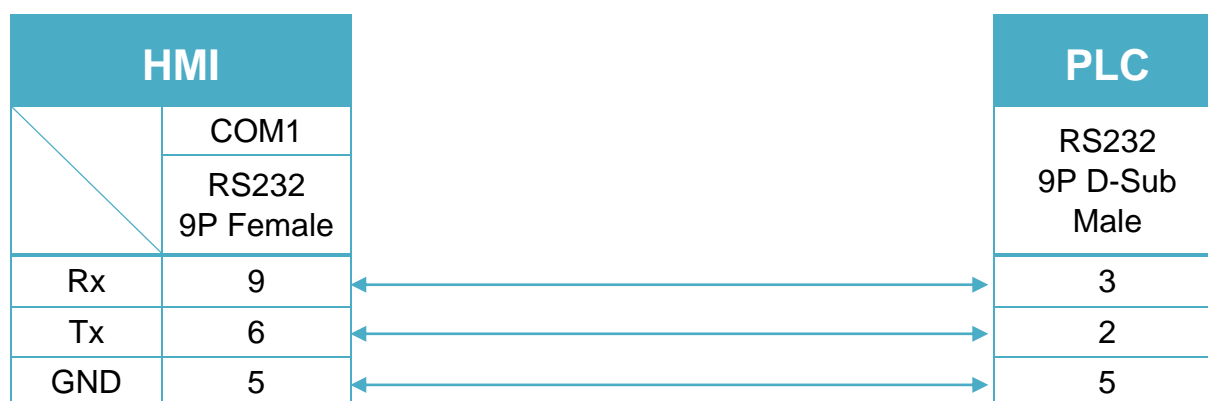
Diagram 2

cMT Series	cMT-SVR
mTV	mTV
MT-iE	MT8070iE / MT6070iE / MT8100iE / MT8121iE / MT8150iE / MT8071iE / MT6071iE / MT8072iE / MT6072iE / MT8073iE / MT8101iE / MT8102iE / MT8103iE
MT-XE	MT8121XE / MT8150XE / MT8090XE



Diagram 3

MT-iE	MT8050iE
MT-iP	MT6051iP / MT6071iP / MT8071iP



LS MASTER-K10S1

Supported Series: LS MASTER-K10S1

Website: <http://www.lqis.com/>

HMI Setting:

Parameters	Recommended	Options	Notes
PLC type	LS MASTER-K10S1		
PLC I/F	RS232	RS232/RS485	
Baud rate	9600		
Data bits	8	8	
Parity	None	None	
Stop bits	1	1	
PLC sta. no.	0		

Device Address:

Bit/Word	Device	Format	Range	Memo
B	PW_Bit	DDDh	0 ~ 255f	I/O Relay (P)
B	KW_Bit	DDDh	0 ~ 255f	Keep Relay (K)
B	MW_Bit	DDDh	0 ~ 255f	Auxiliary Relay (M)
B	LW_Bit	DDDh	0 ~ 255f	Link Relay (L)
B	FW_Bit	DDDh	0 ~ 255f	Special Relay (F)
B	TX	DDD	0 ~ 255	Timer (T)
B	CX	DDD	0 ~ 255	Counter (C)
W	TW	DDD	0 ~ 255	Timer Present Value
W	CW	DDD	0 ~ 255	Counter Present Value
W	DW	DDDD	0 ~ 9999	Data Register (D)

Wiring Diagram:

Diagram 1

cMT Series	<i>cMT3151</i>
eMT Series	<i>eMT3070 / eMT3105 / eMT3120 / eMT3150</i>
MT-iE	<i>MT8073iE / MT8102iE</i>
MT-XE	<i>MT8092XE</i>
MT-iP	<i>MT6103iP</i>

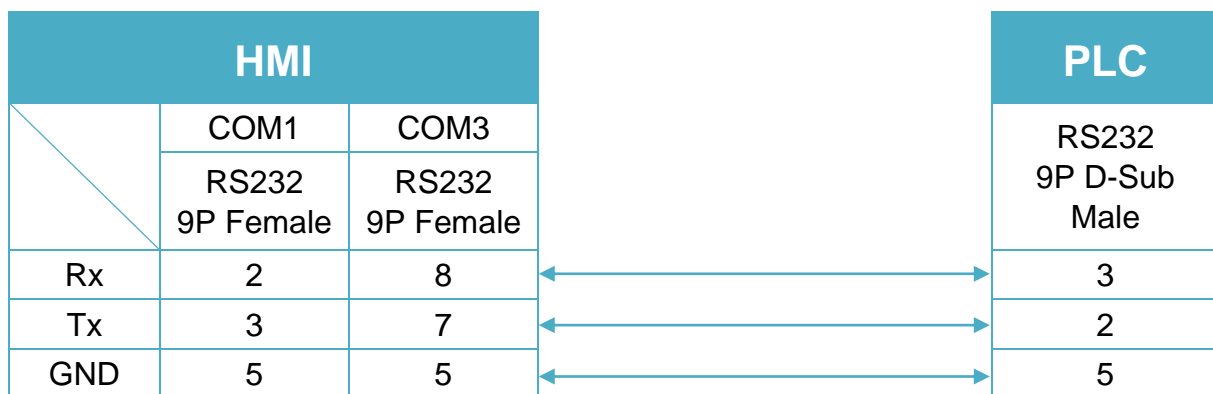


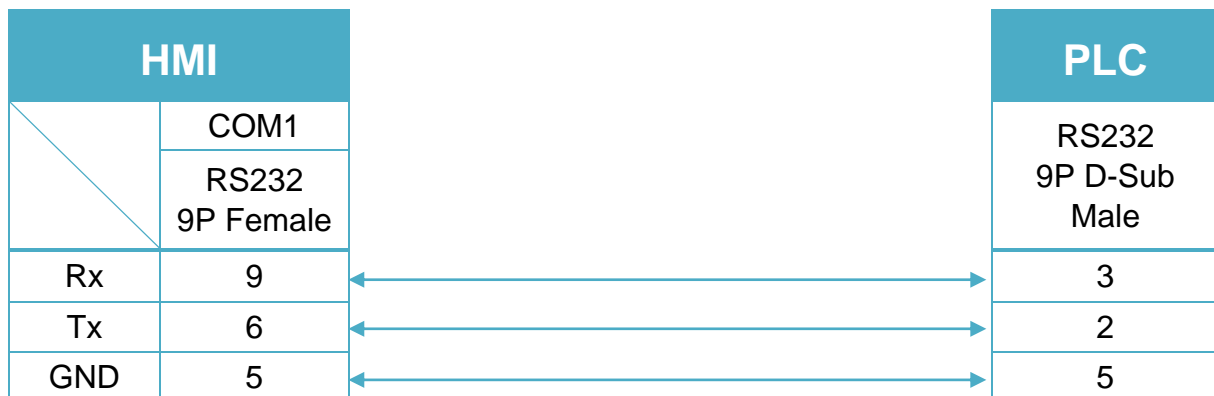
Diagram 2

cMT Series	cMT-SVR
mTV	mTV
MT-iE	MT8070iE / MT6070iE / MT8100iE / MT8121iE / MT8150iE / MT8071iE / MT6071iE / MT8072iE / MT6072iE / MT8073iE / MT8101iE / MT8102iE / MT8103iE
MT-XE	MT8121XE / MT8150XE / MT8090XE



Diagram 3

MT-iE	MT8050iE
MT-iP	MT6051iP / MT6071iP / MT8071iP



LS XBM/XBC Cnet

Supported Series: LS XGB Series XBM/XBC CPU with communication module XGL-CH2A.

Website: <http://www.lgjs.com/>

HMI Setting:

Parameters	Recommended	Options	Notes
PLC type	LS XBM/XBC Cnet		
PLC I/F	RS232	RS232/RS485	
Baud rate	115200	9600~115200	
Data bits	8	7, 8	
Parity	None	Even, Odd, None	
Stop bits	1	1	
PLC sta. no.	1	0-31	

Device Address:

Bit/Word	Device type	Format	Range	Memo
B	PW_Bit	DDDDh	0 ~ 2047f	I/O device Bit
B	MW_Bit	DDDDh	0 ~ 2047f	Internal device Bit
B	LW_Bit	DDDDDh	0 ~ 11263f	Communication device Bit
B	KW_Bit	DDDDh	0 ~ 2559f	Preservation device Bit
B	FW_Bit	DDDDh	0 ~ 2047f	Special device Bit(write available from 1025)
B	DW_Bit	DDDDDh	0 ~ 32767f	Data register_Bit expression (D0000.0)
B	UW_Bit	DH.DDh	0 ~ 7f.31f	XGK-CPUE : hh(0~1f)
B	RW_Bit	DDDDDh	0 ~ 32767f	
B	SX	DDDDD	0 ~ 12799	Relay for step control Bit
B	TX	DDDD	0 ~ 2047	Timer device Bit
B	CX	DDDD	0 ~ 2047	Counter device Bit
W	PW	DDDD	0 ~ 2047	I/O device_2,048 points
W	MW	DDDD	0 ~ 2047	Internal device_4,096 points
W	LW	DDDDD	0 ~ 11263	Communication device_20,480 points

Bit/Word	Device type	Format	Range	Memo
W	KW	DDDD	0 ~ 2559	Preservation device_4,096 points
W	FW	DDDD	0 ~ 2047	Special device_4,096 point
W	DW	DDDDD	0 ~ 32767	Data register_5120 words
W	UW	DH.DD	0.00 ~ 7f.31	Analog data register_256 words
W	RW	DDDDD	0 ~ 32767	
W	SW	DDDDD	0 ~ 127	Relay for step control
W	TW	DDDD	0 ~ 2047	Timer current value register_256 words
W	CW	DDDD	0 ~ 2047	Counter current value register_256 words
W	NW	DDDDD	0 ~ 21503	Communication data register_3,936 words
W	ZW	DDD	0 ~ 127	Index register_128 words

Wiring Diagram:

RS232 9P D-Sub (Diagram 1 ~ Diagram 3)

Diagram 1

cMT Series	<i>cMT3151</i>
eMT Series	<i>eMT3070/ eMT3105 / eMT3120 / eMT3150</i>
MT-iE	<i>MT8073iE / MT8102iE</i>
MT-XE	<i>MT8092XE</i>
MT-iP	<i>MT6103iP</i>

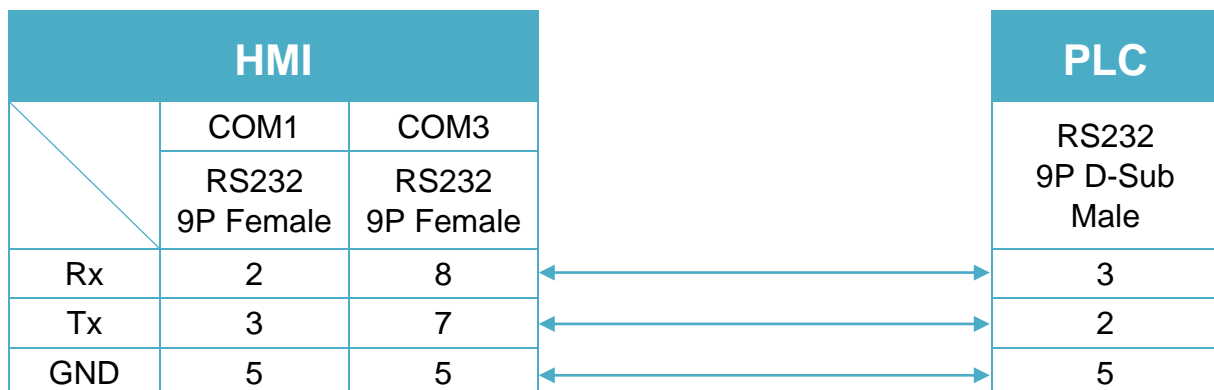


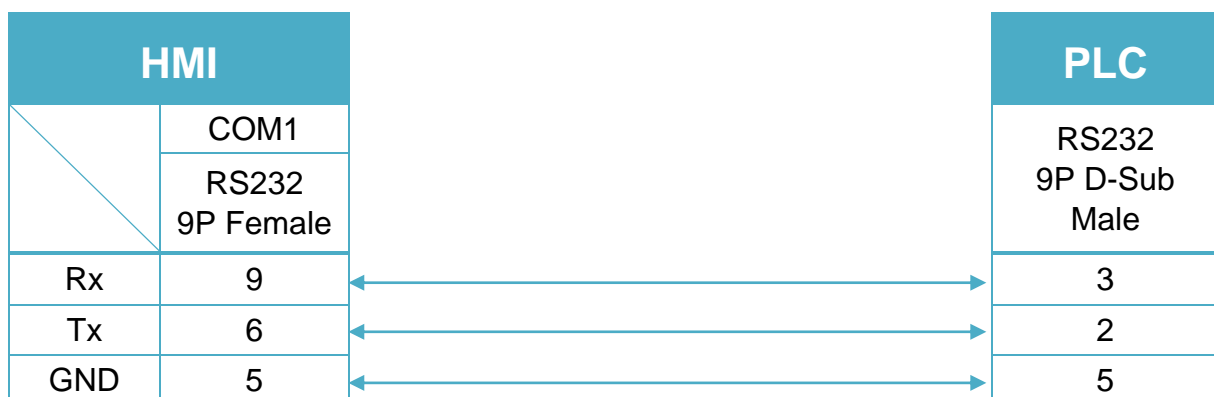
Diagram 2

cMT Series	cMT-SVR
mTV	mTV
MT-iE	MT8070iE / MT6070iE / MT8100iE / MT8121iE / MT8150iE / MT8071iE / MT6071iE / MT8072iE / MT6072iE / MT8073iE / MT8101iE / MT8102iE / MT8103iE
MT-XE	MT8121XE / MT8150XE / MT8090XE



Diagram 3

MT-iE	MT8050iE
MT-iP	MT6051iP / MT6071iP / MT8071iP



RS485 2W Terminal (Diagram 4 ~ Diagram 9)

Diagram 4

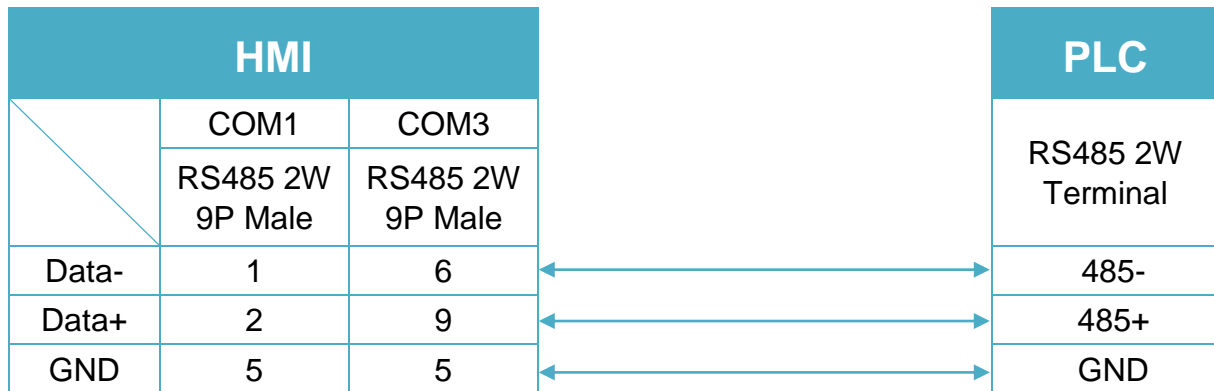
cMT Series *cMT3151*
eMT Series *eMT3070 / eMT3105 / eMT3120 / eMT3150*


Diagram 5

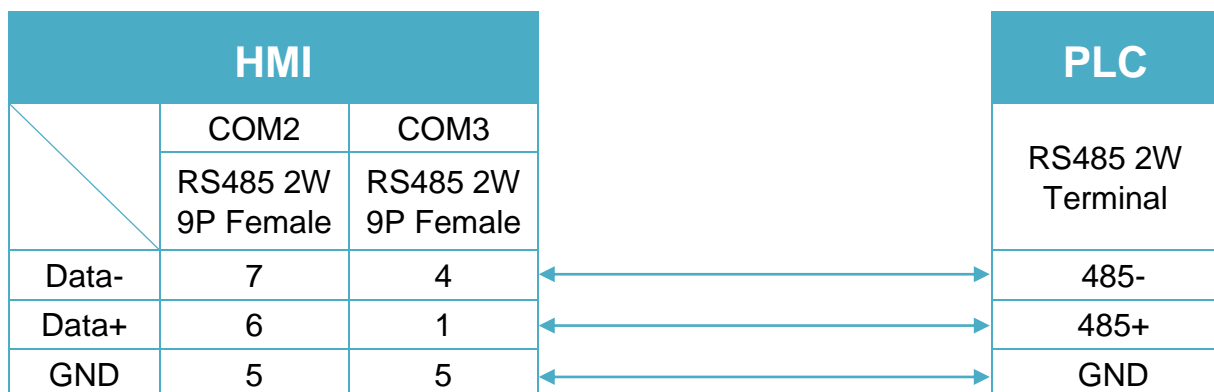
cMT Series *cMT-SVR*
mTV *mTV*


Diagram 6

MT-iE *MT8070iE / MT6070iE / MT8100iE / MT8121iE / MT8150iE*

MT-XE *MT8121XE / MT8150XE*

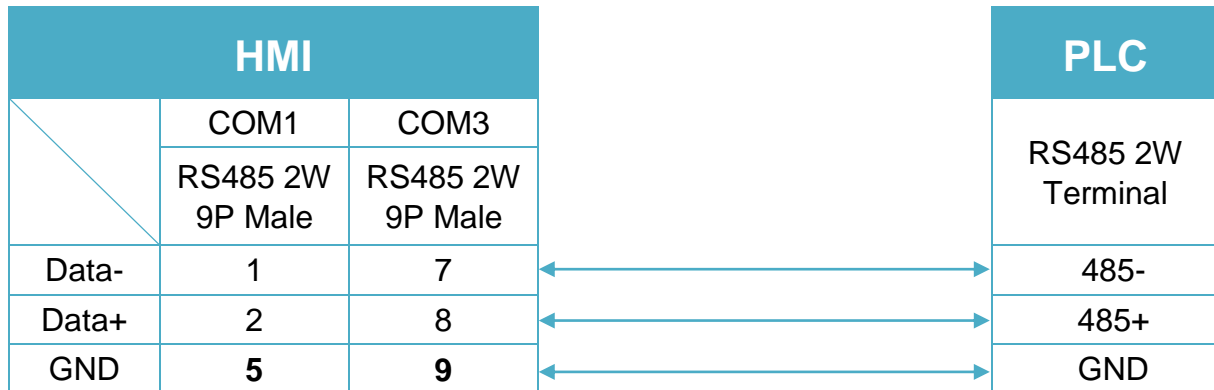


Diagram 7

MT-iE *MT8071iE / MT6071iE / MT8072iE / MT6072iE / MT8073iE / MT8101iE / MT8102iE / MT8103iE*

MT-XE *MT8090XE / MT8092XE*

MT-iP *MT6103iP*

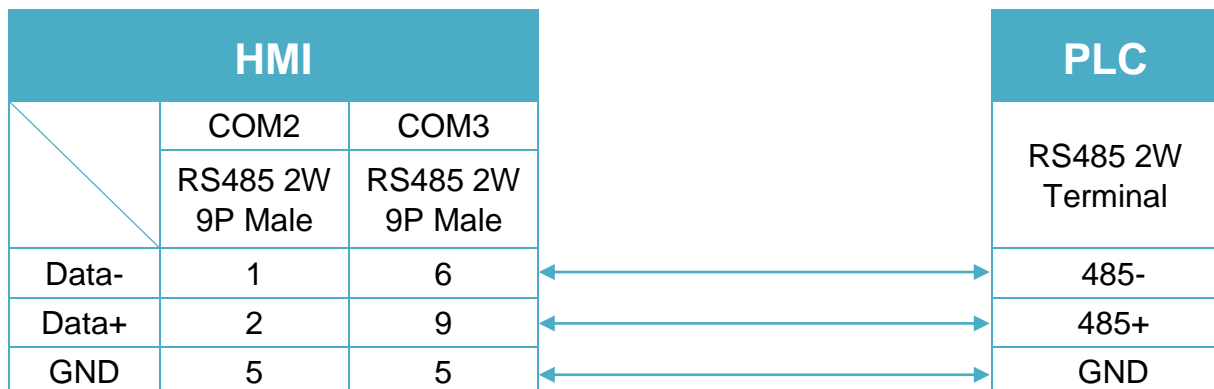


Diagram 8

MT-iE *MT8050iE*

MT-iP *MT6051iP*

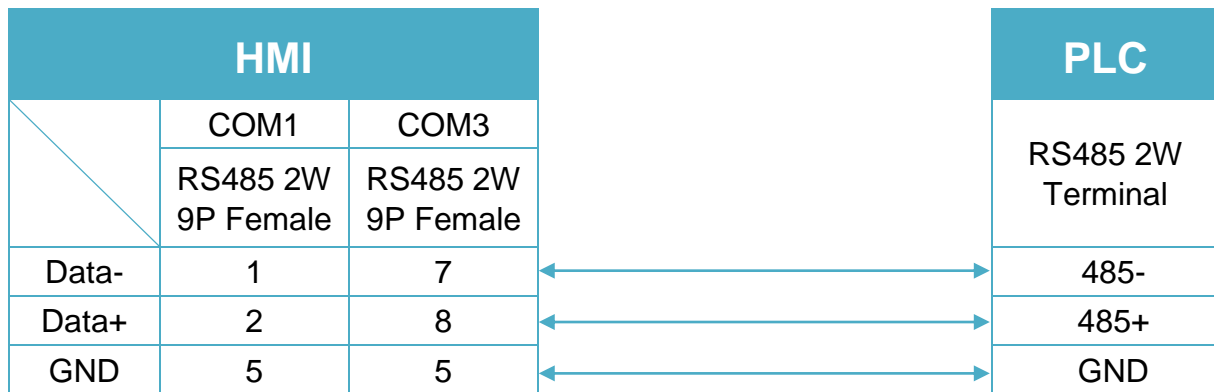


Diagram 9

MT-iP *MT6071iP / MT8071iP*



LS XBM/XBC FEnet (Ethernet)

Supported Series: LS XGB series XBM/XBC CPU with XBL-EFMT ethernet module.

Website: <http://www.lgjs.com/>

HMI Setting:

Parameters	Recommended	Options	Notes
PLC type	LS XBM/XBC FEnet (Ethernet)		
PLC I/F	Ethernet		
Port no.	2004		
PLC sta. no.	0	0~255	

PLC Setting:

Communication mode	FEnet Protocol
---------------------------	----------------

Device Address:

Bit/Word	Device	Format	Range	Memo
B	PW_Bit	DDDDh	0 ~ 2047f	I/O device Bit
B	MW_Bit	DDDDh	0 ~ 2047f	Internal device Bit
B	LW_Bit	DDDDDh	0 ~ 11263f	Communication device Bit
B	KW_Bit	DDDDh	0 ~ 2559f	Preservation device Bit
B	FW_Bit	DDDDh	0 ~ 2047f	Special device Bit(write available from 1025)
B	DW_Bit	DDDDDh	0 ~ 32767f	Data register_Bit expression
B	UW_Bit	DH.DDh	0 ~ 7f.31f	XGK-CPUE : hh(0~1f)
B	RW_Bit	DDDDDf	0 ~ 32767f	
B	NW_Bit	DDDDh	0 ~ 2047f	
B	ZW_Bit	DDDDh	0 ~ 2047f	
B	SX	DDDDD	0 ~ 12799	Relay for step control Bit
B	TX	DDDD	0 ~ 2047	Timer device Bit
B	CX	DDDD	0 ~ 2047	Counter device Bit
W	PW	DDDD	0 ~ 2047	I/O device_2,048 points
W	MW	DDDD	0 ~ 2047	Internal device_4,096 points
W	LW	DDDDD	0 ~ 11263	Communication device_20,480
W	KW	DDDD	0 ~ 2559	Preservation device_4,096 points
W	FW	DDDD	0 ~ 2047	Special device_4,096 point
W	DW	DDDDD	0 ~ 32767	Data register_5120 words

Bit/Word	Device	Format	Range	Memo
W	UW	DH.DD	0.00 ~ 7f.31	Analog data register_256 words
W	RW	DDDDD	0 ~ 32767	
W	SW	DDDDD	0 ~ 127	Relay for step control
W	TW	DDDD	0 ~ 2047	Timer current value register_256 words
W	CW	DDDD	0 ~ 2047	Counter current value register_256 words
W	NW	DDDDD	0 ~ 21503	Communication data register_3,936 words
W	ZW	DDD	0 ~ 127	Index register_128 words

Wiring Diagram:

Ethernet cable:



LS XBM/XBC/XGK CPU DIRECT

Supported Series: LS XBM/XBC/XGK CPU RS232 port.

Website: <http://www.lgis.com/>

HMI Setting:

Parameters	Recommended	Options	Notes
PLC type	LS XBM/XBC/XGK CPU DIRECT		
PLC I/F	RS232	RS232	
Baud rate	115200	9600~115200	
Data bits	8	7, 8	
Parity	None	Even, Odd, None	
Stop bits	1	1	
PLC sta. no.	1	1	

Device Address:

Bit/Word	Device type	Format	Range	Memo
B	PW_Bit	DDDDh	0 ~ 2047f	I/O device Bit
B	MW_Bit	DDDDh	0 ~ 2047f	Internal device Bit
B	LW_Bit	DDDDDh	0 ~ 11263f	Communication device Bit
B	KW_Bit	DDDDh	0 ~ 2559f	Preservation device Bit
B	FW_Bit	DDDDh	0 ~ 2047f	Special device Bit(write available from
B	DW_Bit	DDDDDh	0 ~ 32767f	Data register_Bit expression
B	UW_Bit	DH.DDh	0 ~ 3f.31f	XGK-CPUE : hh(0~1f)
B	RW_Bit	DDDDDh	0 ~ 32767f	
B	SX	DDDDD	0 ~ 12799	Relay for step control Bit
B	TX	DDDD	0 ~ 2047	Timer device Bit
B	CX	DDDD	0 ~ 2047	Counter device Bit
W	PW	DDDD	0 ~ 2047	I/O device
W	MW	DDDD	0 ~ 2047	Internal device
W	LW	DDDDD	0 ~ 11263	Communication device
W	KW	DDDD	0 ~ 2559	Preservation device
W	FW	DDDD	0 ~ 2047	Special device(write available
W	SW	DDDDD	0 ~ 127	Relay for step control
W	DW	DDDDD	0 ~ 32767	Data register
W	UW	DH.DD	0.00 ~ 3f.31	Analog data register XGK-CPUE : hh(0~1f)

Bit/Word	Device type	Format	Range	Memo
W	NW	DDDDD	0 ~ 21503	Communication data register
W	ZW	DDD	0 ~ 127	Index register_128 words
W	TW	DDDD	0 ~ 2047	Timer current value register
W	CW	DDDD	0 ~ 2047	Counter current value register
W	RW	DDDDD	0 ~ 32767	
W	ZRW	DDDDD	0 ~ 32767	
W	TSW	DDDD	0 ~ 2047	Setup value
W	CSW	DDDD	0 ~ 2047	Setup value

Wiring Diagram:

XGB RS232 6P Mini-DIN (Diagram 1 ~ Diagram 3)

The following is the view from the soldering point of a connector.



Diagram 1

cMT Series	cMT3151
eMT Series	eMT3070 / eMT3105 / eMT3120 / eMT3150
MT-iE	MT8073iE / MT8102iE
MT-XE	MT8092XE
MT-iP	MT6103iP

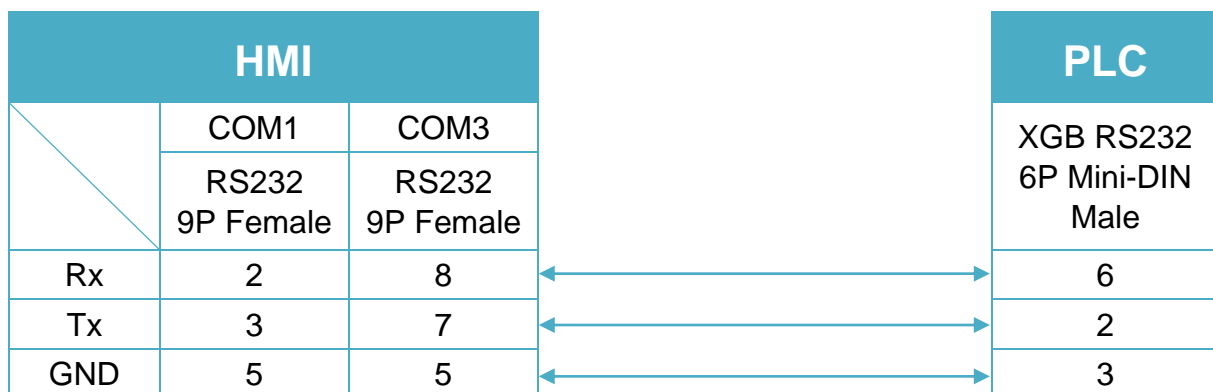


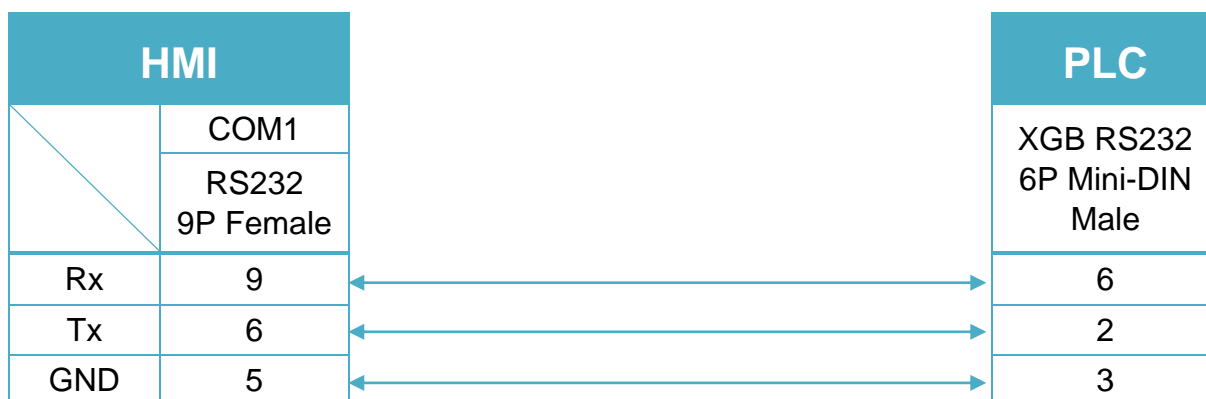
Diagram 2

cMT Series	cMT-SVR
mTV	mTV
MT-iE	MT8070iE / MT6070iE / MT8100iE / MT8121iE / MT8150iE / MT8071iE / MT6071iE / MT8072iE / MT6072iE / MT8073iE / MT8101iE / MT8102iE / MT8103iE
MT-XE	MT8121XE / MT8150XE / MT8090XE /



Diagram 3

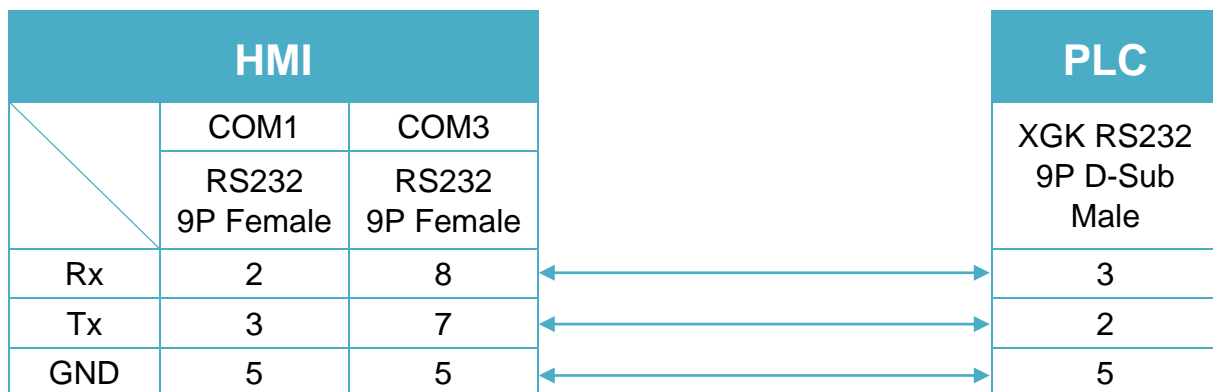
MT-iE	MT8050iE
MT-iP	MT6051iP / MT6071iP / MT8071iP



XGK RS232 9P D-Sub Male (Diagram 4 ~ Diagram 6)

Diagram 4

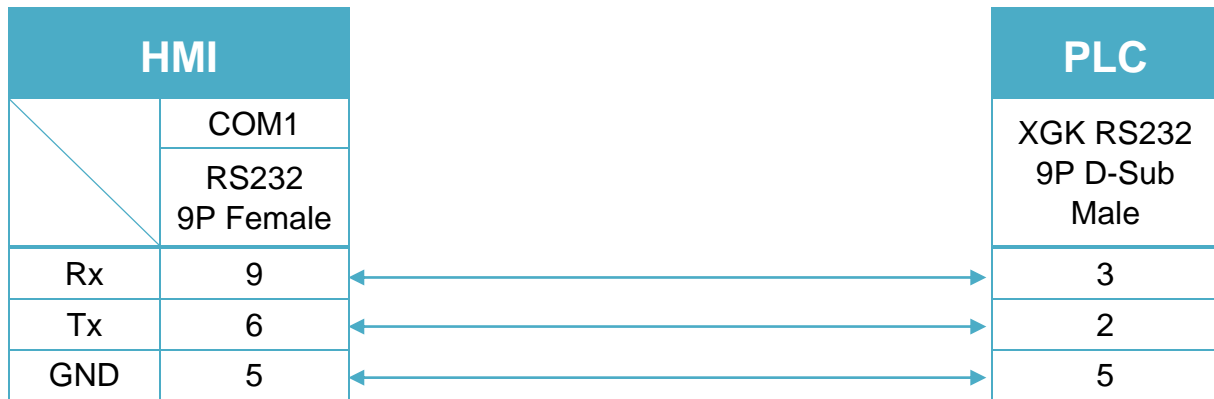
cMT Series	<i>cMT3151</i>
eMT Series	<i>eMT3070 / eMT3105 / eMT3120 / eMT3150</i>
MT-iE	<i>MT8073iE / MT8102iE</i>
MT-XE	<i>MT8092XE</i>
MT-iP	<i>MT6103iP</i>


Diagram 5

cMT Series	<i>cMT-SVR</i>
mTV	<i>mTV</i>
MT-iE	<i>MT8070iE / MT6070iE / MT8100iE / MT8121iE / MT8150iE / MT8071iE / MT6071iE / MT8072iE / MT6072iE / MT8073iE / MT8101iE / MT8102iE / MT8103iE</i>
MT-XE	<i>MT8121XE / MT8150XE / MT8090XE /</i>



Diagram 6

MT-iE
MT8050iE
MT-iP
MT6051iP / MT6071iP / MT8071iP


LS XEC Cnet

Supported Series: LS XGB Series XEC CPU with communication module XGL-CH2A.

Website: <http://www.lgjs.com/>

HMI Setting:

Parameters	Recommended	Options	Notes
PLC type	LS XEC Cnet		
PLC I/F	RS232	RS232/RS485	
Baud rate	115200	9600 ~ 115200	
Data bits	8	7, 8	
Parity	None	Even, Odd, None	
Stop bits	1	1,2	
PLC sta. no.	0	0 ~ 32	

Device Address:

Bit/Word	Device type	Format	Range	Memo
B	AW_Bit	DDDDDDh	0 ~ 262143f	Automatic variable bit
B	IW_Bit	DDD.DD.Dh	0 ~ 127.15.3f	Input device bit
B	QW_Bit	DDD.DD.Dh	0 ~ 127.15.3f	Output device bit
B	MW_Bit	DDDDDDh	0 ~ 131071f	Direct variable bit
B	RW_Bit	DDDDh	0 ~ 32767f	Direct variable bit
B	WW_Bit	DDDDh	0 ~ 65535f	Direct variable bit
B	FW_Bit	DDDDh	0 ~ 2047f	System flag bit
B	KW_Bit	DDDDh	0 ~ 8399f	Built-in special flag bit
B	LW_Bit	DDDDh	0 ~ 11263f	High speed link flag bit
B	NW_Bit	DDDDh	0 ~ 25087f	P2P flag bit
B	UW_Bit	DD.DD.DDh	0 ~ 31.15.31f	Analog flag bit
B	AX	DDDDDDDD	0 ~ 4194303	
B	IX	DDD.DD.DD	0 ~ 127.15.63	
B	QX	DDD.DD.DD	0 ~ 127.15.63	
B	MX	DDDDDDDD	0 ~ 2097151	
B	RX	DDDDDD	0 ~ 524287	
B	WX	DDDDDDDD	0 ~ 1048575	
B	FX	DDDDD	0 ~ 32767	
B	KX	DDDDDD	0 ~ 134399	

Bit/Word	Device type	Format	Range	Memo
B	LX	DDDDDDDD	0 ~ 1880223	
B	NX	DDDDDD	0 ~ 401407	
B	UX	DD.DD.DDD	0 ~ 31.15.511	
W	AW	DDDDDD	0 ~ 262143	Automatic variable
W	IW	DDD.DD.D	0 ~ 127.15.3	Input device
W	QW	DDD.DD.D	0 ~ 127.15.3	Output device
W	MW	DDDDDD	0 ~ 131071	Direct variable
W	RW	DDDDD	0 ~ 32767	Direct variable
W	WW	DDDDD	0 ~ 65535	Direct variable
W	FW	DDDD	0 ~ 2047	System flag
W	KW	DDDD	0 ~ 8399	Built-in special flag
W	LW	DDDDD	0 ~ 11263	High speed link flag
W	NW	DDDDD	0 ~ 25087	P2P flag
W	UW	DD.DD.DD	0 ~ 31.15.31	Analog flag
DW	MD	DDDDD	0 ~ 65535	

Wiring Diagram:

RS232 Terminal (Diagram 1 ~ Diagram 3)

Diagram 1

cMT Series	<i>cMT3151</i>
eMT Series	<i>eMT3070 / eMT3105 / eMT3120 / eMT3150</i>
MT-iE	<i>MT8073iE / MT8102iE</i>
MT-XE	<i>MT8092XE</i>
MT-iP	<i>MT6103iP</i>

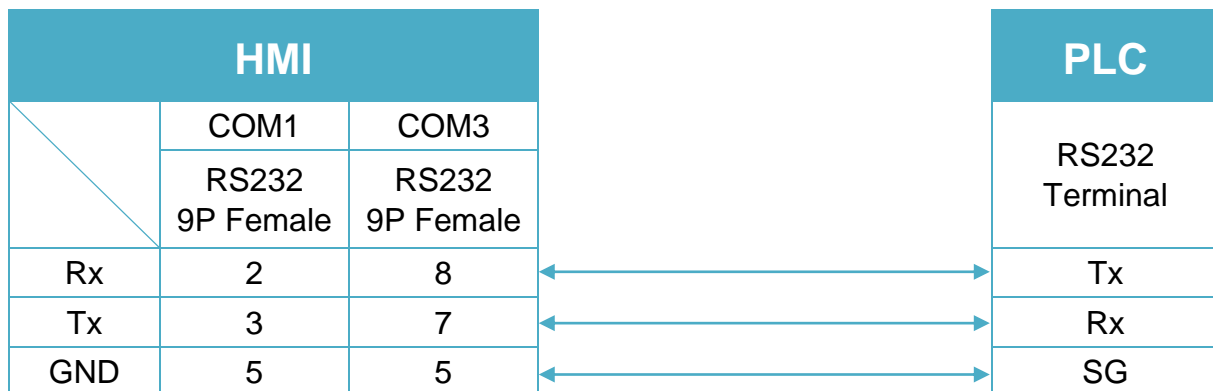


Diagram 2

cMT Series	<i>cMT-SVR</i>
mTV	<i>mTV</i>
MT-iE	<i>MT8070iE / MT6070iE / MT8100iE / MT8121iE / MT8150iE / MT8071iE / MT6071iE / MT8072iE / MT6072iE / MT8073iE / MT8101iE / MT8102iE / MT8103iE</i>
MT-XE	<i>MT8121XE / MT8150XE / MT8090XE /</i>

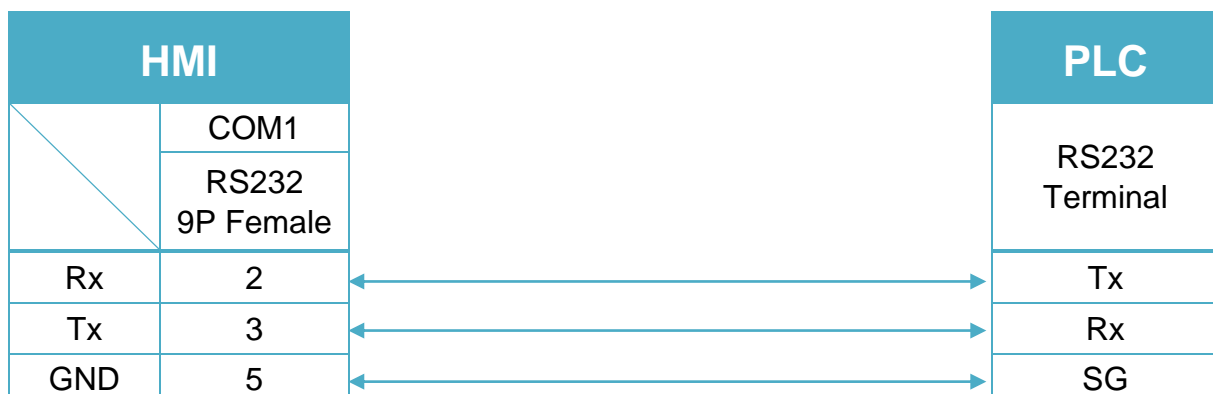


Diagram 3

MT-iE	MT8050iE
MT-iP	MT6051iP / MT6071iP / MT8071iP



RS485 2W Terminal (Diagram 4 ~ Diagram 9)

Diagram 4

cMT Series	cMT3151
eMT Series	eMT3070 / eMT3105 / eMT3120 / eMT3150

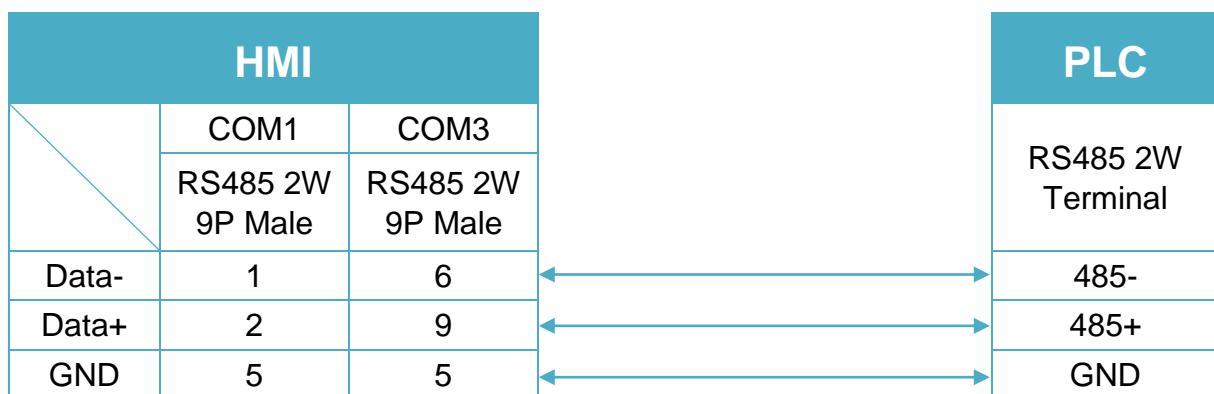


Diagram 5

cMT Series *cMT-SVR*

mTV *mTV*

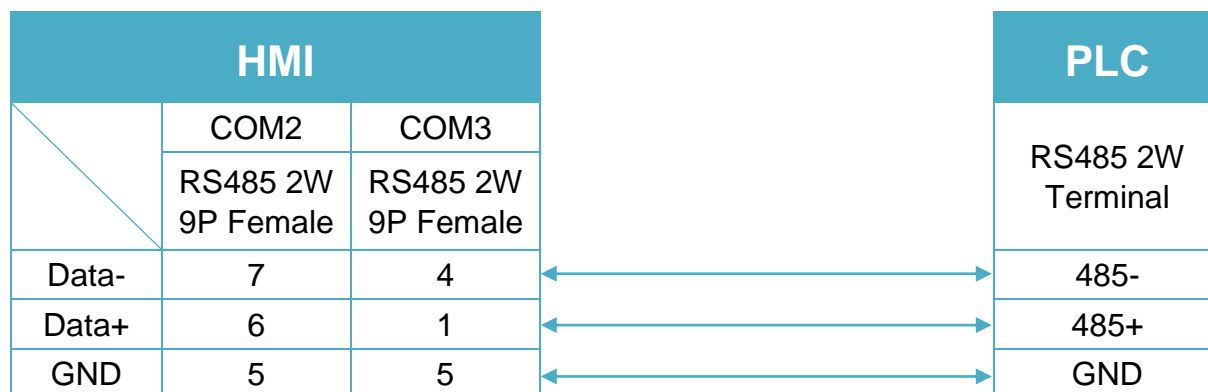


Diagram 6

MT-iE *MT8070iE / MT6070iE / MT8100iE / MT8121iE / MT8150iE*

MT-XE *MT8121XE / MT8150XE*

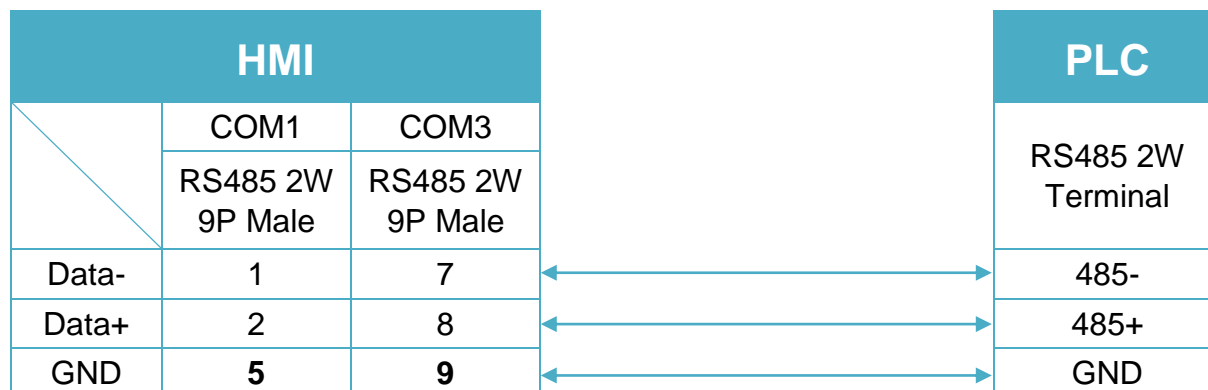


Diagram 7

MT-iE	<i>MT8071iE / MT6071iE / MT8072iE / MT6072iE / MT8073iE / MT8101iE / MT8102iE / MT8103iE</i>
MT-XE	<i>MT8090XE / MT8092XE</i>
MT-iP	<i>MT6103iP</i>

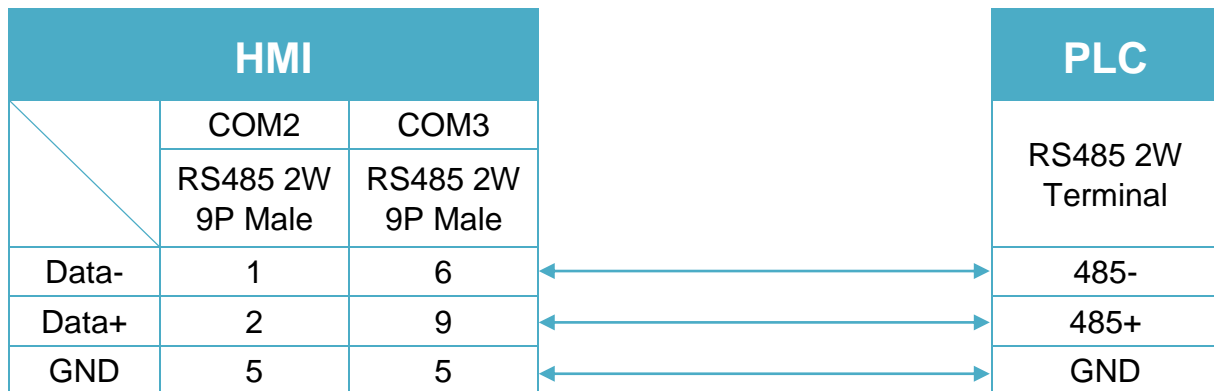


Diagram 8

MT-iE	<i>MT8050iE</i>
MT-iP	<i>MT6051iP</i>

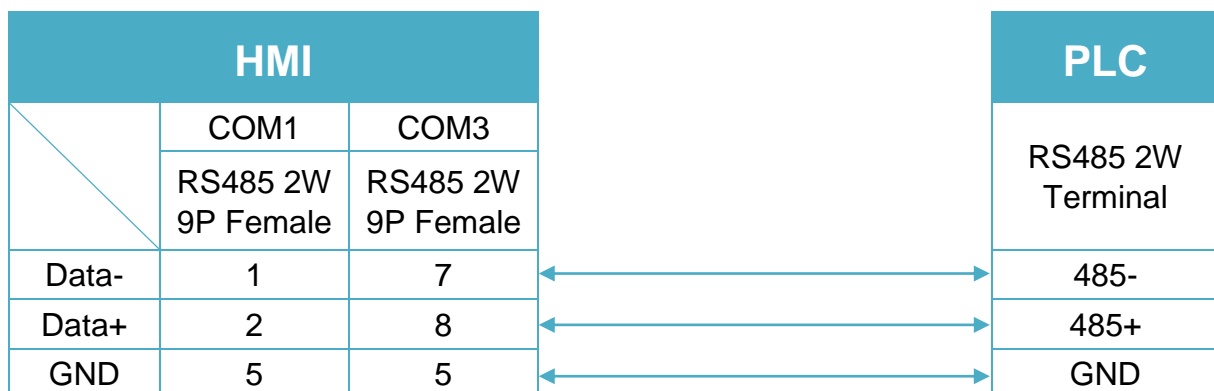
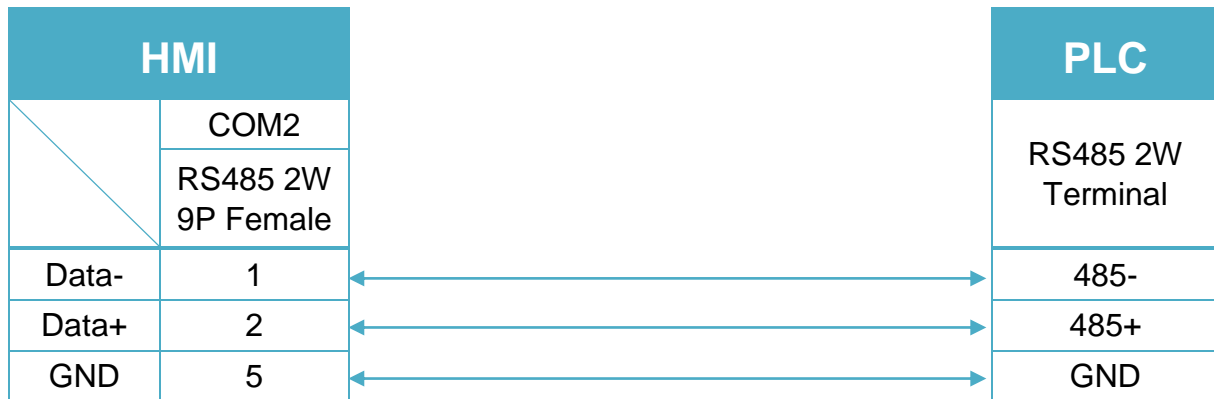


Diagram 9

MT-iP
MT6071iP / MT8071iP


LS XEC FEnet (Ethernet)

Supported Series: LS XGB Series XEC CPU with XGL-EFMT 600thernet module.

Website: <http://www.lgis.com/>

HMI Setting:

Parameters	Recommended	Options	Notes
PLC type	LS XEC Fenet (Ethernet)		
PLC I/F	Ethernet		
Port no.	2004		

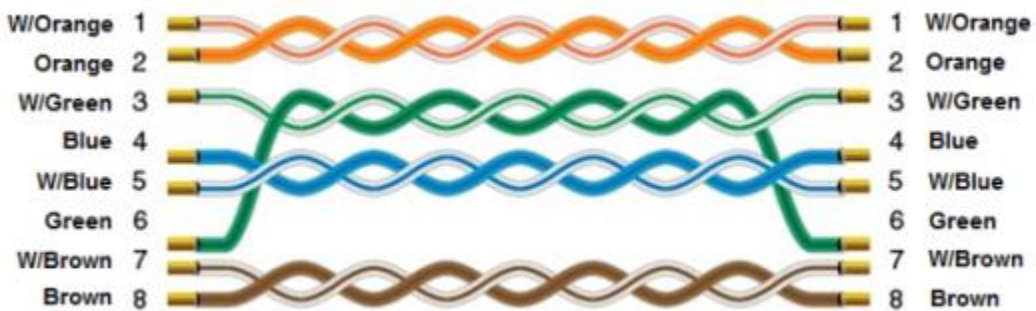
Device Address:

Bit/Word	Device	Format	Range	Memo
B	AW_Bit	DDDDh	0 ~ 16383f	Automatic variable bit
B	IW_Bit	DD.DD.Df	0 ~ 15.15.3f	Input device bit
B	QW_Bit	DD.DD.Df	0 ~ 15.15.3f	Output device bit
B	MW_Bit	DDDDh	0 ~ 8191f	Direct variable bit
B	RW_Bit	DDDDh	0 ~ 10239f	Direct variable bit
B	WW_Bit	DDDDh	0 ~ 10239f	Direct variable bit
B	FW_Bit	DDDDh	0 ~ 1023f	System flag bit
B	KW_Bit	DDDDh	0 ~ 4095f	Built-in special flag bit
B	LW_Bit	DDDDh	0 ~ 2047f	High speed link flag bit
B	NW_Bit	DDDDh	0 ~ 5119f	P2P flag bit
B	UW_Bit	DD.DD.DDf	0 ~ 31.15.31f	Analog flag bit
B	AX	DDDDDD	0 ~ 262143	
B	IX	DDD.DD.DD	0 ~ 127.15.63	
B	QX	DDD.DD.DD	0 ~ 127.15.63	
B	MX	DDDDDD	0 ~ 131071	
B	RX	DDDDDD	0 ~ 163839	
B	WX	DDDDDD	0 ~ 163839	
B	FX	DDDDD	0 ~ 16383	
B	KX	DDDDD	0 ~ 65535	
B	LX	DDDDD	0 ~ 32767	
B	NX	DDDDD	0 ~ 81919	
B	UX	DD.DD.DDD	0 ~ 31.15.511	
W	AW	DDDDD	0 ~ 16383	Automatic variable

Bit/Word	Device	Format	Range	Memo
W	IW	DDD.DD.D	0 ~ 15.15.3	Input device
W	QW	DDD.DD.D	0 ~ 15.15.3	Output device
W	MW	DDDD	0 ~ 8191	Direct variable
W	RW	DDDDD	0 ~ 10239	Direct variable
W	WW	DDDDD	0 ~ 10239	Direct variable
W	FW	DDDD	0 ~ 1023	System flag
W	KW	DDDD	0 ~ 4095	Built-in special flag
W	LW	DDDD	0 ~ 2047	High speed link flag
W	NW	DDDD	0 ~ 5119	P2P flag
W	UW	DD.DD.DD	0 ~ 31.15.31	Analog flag
DW	MD	DDDD	0 ~ 4095	

Wiring Diagram:

Ethernet cable:



LS XEC/XGI CPU DIRECT

Supported Series : LS XEC/XGI CPU RS232 port.

Website: <http://www.lgis.com/>

HMI Setting:

Parameters	Recommended	Options	Notes
PLC type	LS XEC/XGI CPU DIRECT		
PLC I/F	RS232	RS232	
Baud rate	115200	9600~115200	
Data bits	8	7, 8	
Parity	None	Even, Odd, None	
Stop bits	1	1	
PLC sta. no.	1	1	

*Support communications between HMI and PLC in pass-through mode

*Set LW-9903 to 2 to enhance the speed of download/upload PLC program in pass-through mode

Device Address:

Bit/Word	Device type	Format	Range	Memo
B	AW_Bit	DDDDDDh	0 ~ 262143f	
B	IW_Bit	DDD.DD.Dh	0 ~ 127.15.3f	
B	QW_Bit	DDD.DD.Dh	0 ~ 127.15.3f	
B	MW_Bit	DDDDDDh	0 ~ 131071f	
B	RW_Bit	DDDDDDh	0 ~ 32767f	
B	WW_Bit	DDDDDDh	0 ~ 65535f	
B	FW_Bit	DDDDh	0 ~ 2047f	
B	KW_Bit	DDDDh	0 ~ 8399f	
B	LW_Bit	DDDDDDh	0 ~ 11263f	
B	NW_Bit	DDDDDDh	0 ~ 25087f	
B	UW_Bit	DD.DD.DDh	0 ~ 31.15.31f	
B	AX	DDDDDDDD	0 ~ 4194303	
B	IX	DDD.DD.DD	0 ~ 127.15.63	
B	QX	DDD.DD.DD	0 ~ 127.15.63	
B	MX	DDDDDDDD	0 ~ 2097151	
B	RX	DDDDDD	0 ~ 524287	

Bit/Word	Device type	Format	Range	Memo
B	WX	DDDDDDDD	0 ~ 1048575	
B	FX	DDDDD	0 ~ 32767	
B	KX	DDDDDD	0 ~ 134399	
B	LX	DDDDDDDD	0 ~ 1880223	
B	NX	DDDDDD	0 ~ 401407	
B	UX	DD.DD.DDD	0 ~ 31.15.511	
W	AW	DDDDDD	0 ~ 262143	
W	IW	DDD.DD.D	0 ~ 127.15.3	
W	QW	DDD.DD.D	0 ~ 127.15.3	
W	MW	DDDDDD	0 ~ 131071	
W	RW	DDDDD	0 ~ 32767	
W	WW	DDDDD	0 ~ 65535	
W	FW	DDDD	0 ~ 2047	
W	KW	DDDD	0 ~ 8399	
W	LW	DDDDD	0 ~ 11263	
W	NW	DDDDD	0 ~ 25087	
W	UW	DD.DD.DD	0 ~ 31.15.31	
DW	MD	DDDDD	0 ~ 65535	

Wiring Diagram:

Diagram 1

cMT Series	<i>cMT3151</i>
eMT Series	<i>eMT3070 / eMT3105 / eMT3120 / eMT3150</i>
MT-iE	<i>MT8073iE / MT8102iE</i>
MT-XE	<i>MT8092XE</i>
MT-iP	<i>MT6103iP</i>

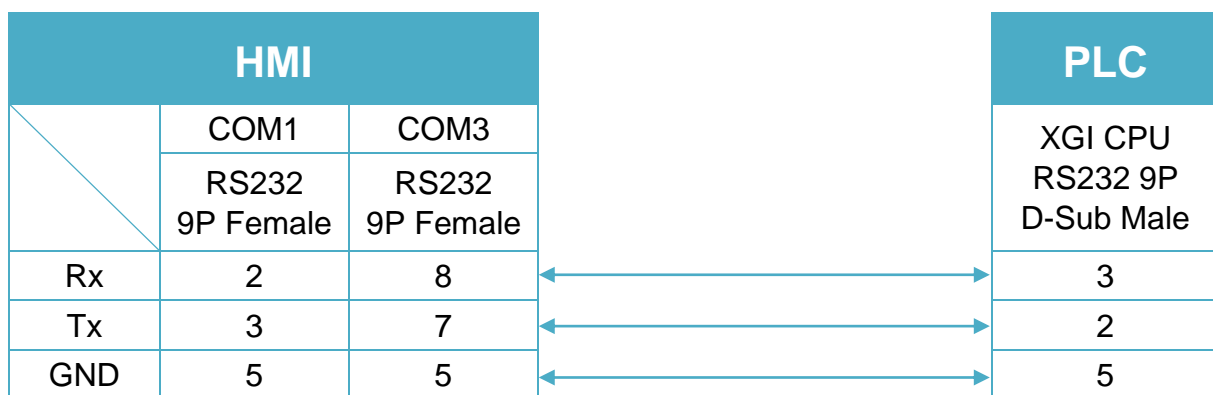


Diagram 2

cMT Series	<i>cMT-SVR</i>
mTV	<i>mTV</i>
MT-iE	<i>MT8070iE / MT6070iE / MT8100iE / MT8121iE / MT8150iE / MT8071iE / MT6071iE / MT8072iE / MT6072iE / MT8073iE / MT8101iE / MT8102iE / MT8103iE</i>
MT-XE	<i>MT8121XE / MT8150XE / MT8090XE /</i>

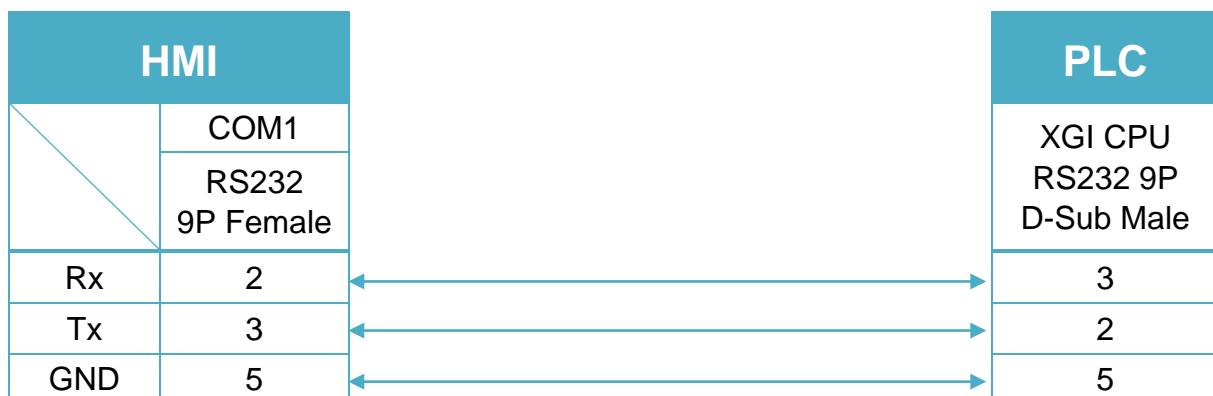
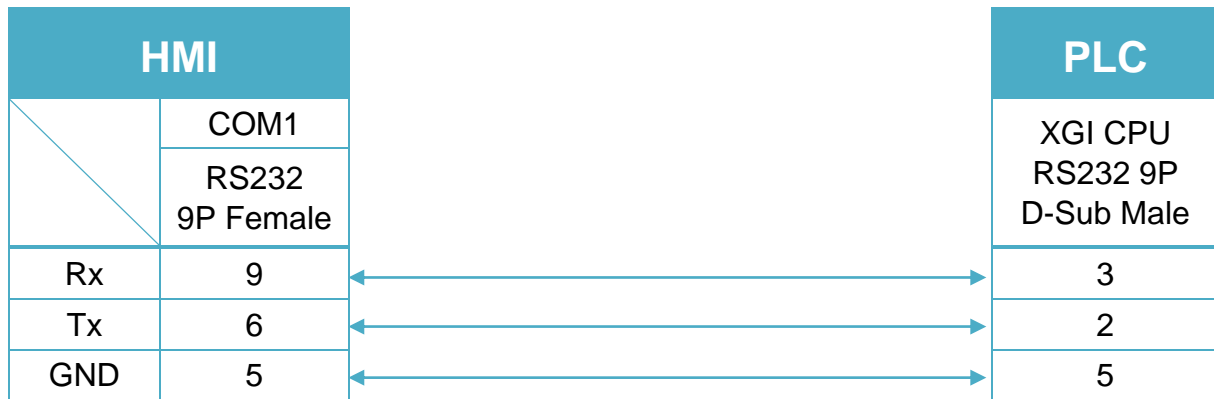


Diagram 3

MT-iE
MT8050iE
MT-iP
MT6051iP / MT6071iP / MT8071iP


LS XGI Cnet

Supported Series: LS XGT series XGI CPU series with communication module XGL-CH2A

Website: <http://www.lgis.com/>

HMI Setting:

Parameters	Recommended	Options	Notes
PLC type	LS XGI Cnet		
PLC I/F	RS232	RS232/RS485 4W	
Baud rate	115200	9600~115200	
Data bits	8	7, 8	
Parity	None	Even, Odd, None	
Stop bits	1	1	
PLC sta. no.	0	0~32	

Device Address:

Bit/Word	Device type	Format	Range	Memo
B	AW_Bit	DDDDDDh	0 ~ 262143f	
B	IW_Bit	DDD.DD.Dh	0 ~ 127.15.3f	
B	QW_Bit	DDD.DD.Dh	0 ~ 127.15.3f	
B	MW_Bit	DDDDDDh	0 ~ 131071f	
B	RW_Bit	DDDDDDh	0 ~ 32767f	
B	WW_Bit	DDDDDDh	0 ~ 65535f	
B	FW_Bit	DDDDh	0 ~ 2047f	
B	KW_Bit	DDDDh	0 ~ 8399f	
B	LW_Bit	DDDDDDh	0 ~ 11263f	
B	NW_Bit	DDDDDDh	0 ~ 25087f	
B	UW_Bit	DD.DD.DDh	0 ~ 31.15.31f	
B	AX	DDDDDDDD	0 ~ 4194303	
B	IX	DDD.DD.DD	0 ~ 127.15.63	
B	QX	DDD.DD.DD	0 ~ 127.15.63	
B	MX	DDDDDDDD	0 ~ 2097151	
B	RX	DDDDDD	0 ~ 524287	
B	WX	DDDDDDDD	0 ~ 1048575	
B	FX	DDDDDD	0 ~ 32767	
B	KX	DDDDDD	0 ~ 134399	

Bit/Word	Device type	Format	Range	Memo
B	LX	DDDDDDDD	0 ~ 1880223	
B	NX	DDDDDD	0 ~ 401407	
B	UX	DD.DD.DDD	0 ~ 31.15.511	
W	AW	DDDDDD	0 ~ 262143	
W	IW	DDD.DD.D	0 ~ 127.15.3	
W	QW	DDD.DD.D	0 ~ 127.15.3	
W	MW	DDDDDD	0 ~ 131071	
W	RW	DDDDD	0 ~ 32767	
W	WW	DDDDD	0 ~ 65535	
W	FW	DDDD	0 ~ 2047	
W	KW	DDDD	0 ~ 8399	
W	LW	DDDDD	0 ~ 11263	
W	NW	DDDDD	0 ~ 25087	
W	UW	DD.DD.DD	0 ~ 31.15.31	
DW	MD	DDDDD	0 ~ 65535	

Wiring Diagram:

XGL-CH2A CH1 RS232 9P D-Sub Male (Diagram 1 ~ Diagram 3)

Diagram 1

cMT Series	<i>cMT3151</i>
eMT Series	<i>eMT3070 / eMT3105 / eMT3120 / eMT3150</i>
MT-iE	<i>MT8073iE / MT8102iE</i>
MT-XE	<i>MT8092XE</i>
MT-iP	<i>MT6103iP</i>

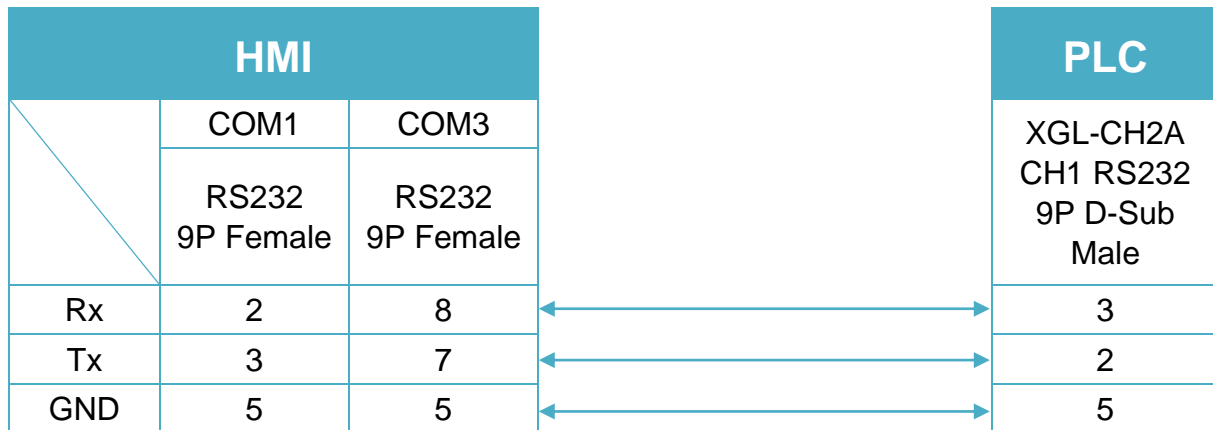


Diagram 2

cMT Series	cMT-SVR
mTV	mTV
MT-iE	MT8070iE / MT6070iE / MT8100iE / MT8121iE / MT8150iE / MT8071iE / MT6071iE / MT8072iE / MT6072iE / MT8073iE / MT8101iE / MT8102iE / MT8103iE
MT-XE	MT8121XE / MT8150XE / MT8090XE /

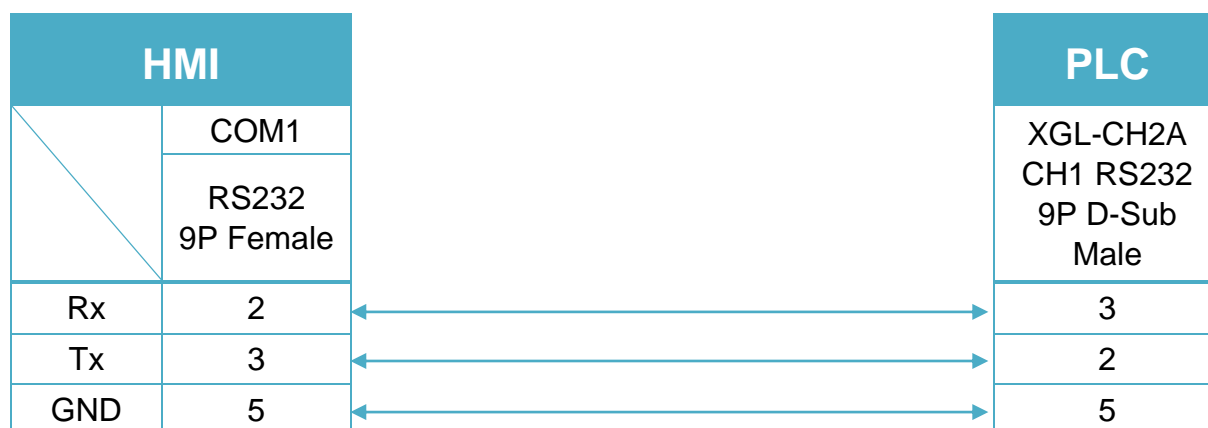
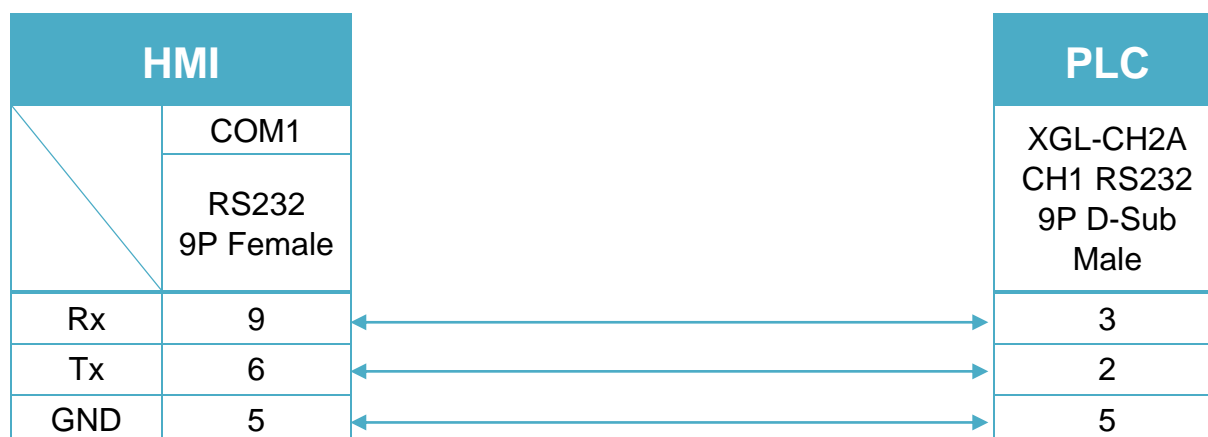


Diagram 3

MT-iE	MT8050iE
MT-iP	MT6051iP / MT6071iP / MT8071iP



XGL-CH2A CH2 5P Terminal (Diagram 4 ~ Diagram 7)

Diagram 4

cMT Series	<i>cMT3151</i>
eMT Series	<i>eMT3070 / eMT3105 / eMT3120 / eMT3150</i>
MT-iE	<i>MT8070iE / MT6070iE / MT8100iE / MT8121iE / MT8150iE</i>
MT-XE	<i>MT8121XE / MT8150XE</i>

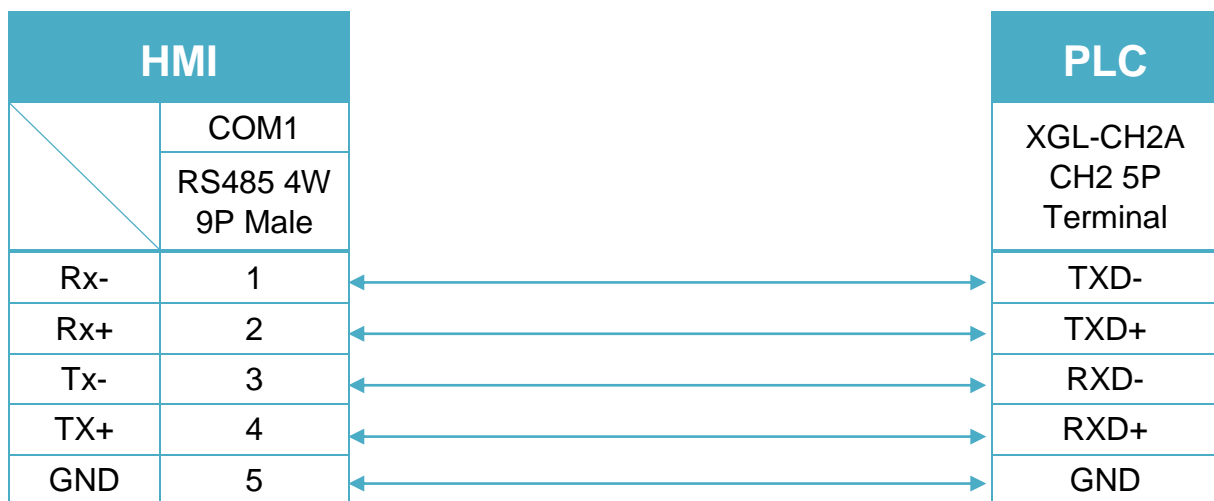


Diagram 5

cMT Series	<i>cMT-SVR</i>
mTV	<i>mTV</i>

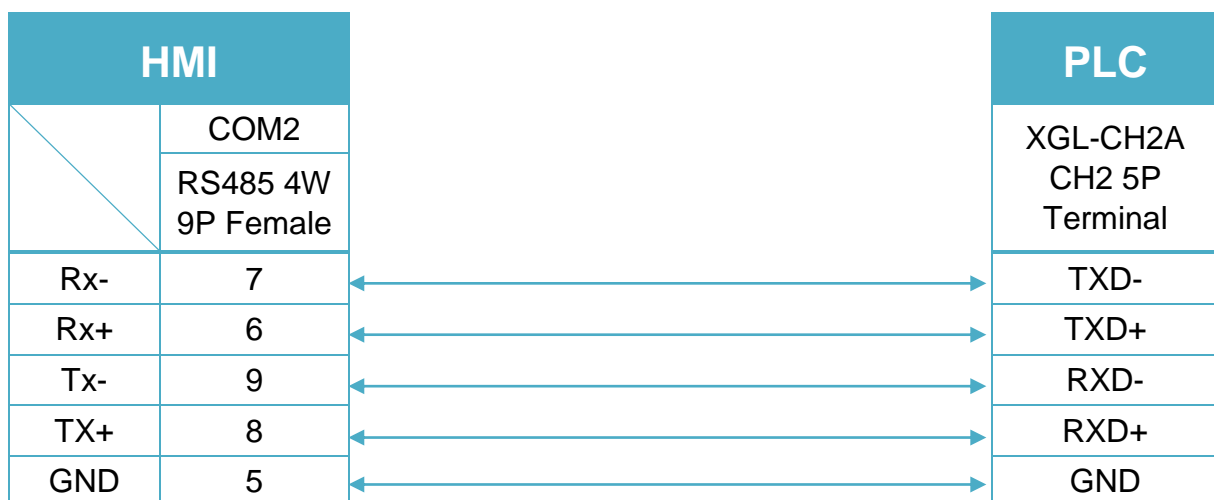


Diagram 6

MT-iE	<i>MT8071iE / MT6071iE / MT8072iE / MT6072iE / MT8073iE / MT8101iE / MT8102iE / MT8103iE</i>
MT-XE	<i>MT8090XE / MT8092XE</i>
MT-iP	<i>MT6071iP / MT8071iP / MT6103iP</i>

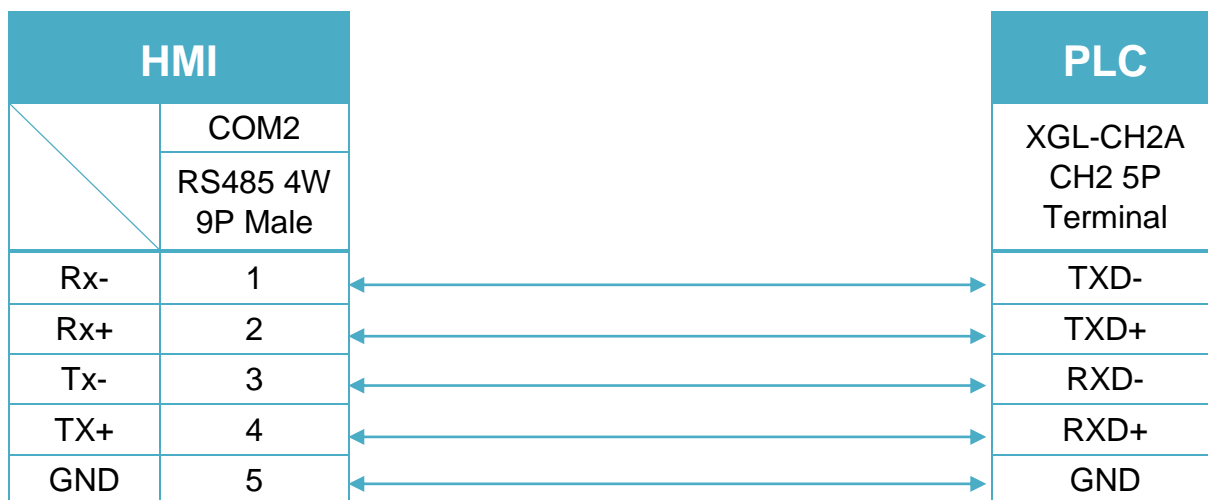
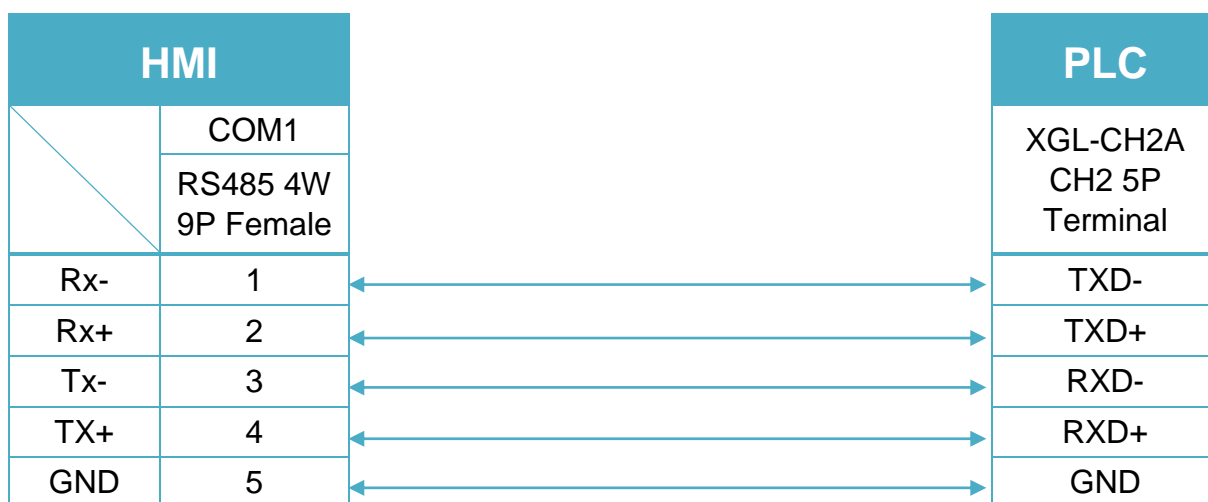


Diagram 7

MT-iE	<i>MT8050iE</i>
MT-iP	<i>MT6051iP</i>



LS XGI Fenet (Ethernet)

Supported Series: LS XGT series XGI CPU with XGL-EFMT 612thernet module.

Website: <http://www.lgjs.com/>

HMI Setting:

Parameters	Recommended	Options	Notes
PLC type	LS XGI Fenet (Ethernet)		
PLC I/F	Ethernet		
Port no.	2004		
PLC sta. no.	0		

Device Address:

Bit/Word	Device type	Format	Range	Memo
B	AW_Bit	DDDDDDh	0 ~ 262143f	
B	IW_Bit	DDD.DD.Dh	0 ~ 127.15.3f	
B	QW_Bit	DDD.DD.Dh	0 ~ 127.15.3f	
B	MW_Bit	DDDDDDh	0 ~ 131071f	
B	RW_Bit	DDDDDDh	0 ~ 32767f	
B	WW_Bit	DDDDDDh	0 ~ 65535f	
B	FW_Bit	DDDDh	0 ~ 2047f	
B	KW_Bit	DDDDh	0 ~ 8399f	
B	LW_Bit	DDDDDDh	0 ~ 11263f	
B	NW_Bit	DDDDDDh	0 ~ 25087f	
B	UW_Bit	DD.DD.DDh	0 ~ 31.15.31f	
B	AX	DDDDDDDD	0 ~ 4194303	
B	IX	DDD.DD.DD	0 ~ 127.15.63	
B	QX	DDD.DD.DD	0 ~ 127.15.63	
B	MX	DDDDDDDD	0 ~ 2097151	
B	RX	DDDDDDDD	0 ~ 524287	
B	WX	DDDDDDDD	0 ~ 1048575	
B	FX	DDDDDD	0 ~ 32767	
B	KX	DDDDDDDD	0 ~ 134399	
B	LX	DDDDDDDD	0 ~ 1880223	
B	NX	DDDDDDDD	0 ~ 401407	
B	UX	DD.DD.DDD	0 ~ 31.15.511	

Bit/Word	Device type	Format	Range	Memo
W	AW	DDDDDD	0 ~ 262143	
W	IW	DDD.DD.D	0 ~ 127.15.3	
W	QW	DDD.DD.D	0 ~ 127.15.3	
W	MW	DDDDDD	0 ~ 131071	
W	RW	DDDDD	0 ~ 32767	
W	WW	DDDDD	0 ~ 65535	
W	FW	DDDD	0 ~ 2047	
W	KW	DDDD	0 ~ 8399	
W	LW	DDDDD	0 ~ 11263	
W	NW	DDDDD	0 ~ 25087	
W	UW	DD.DD.DD	0 ~ 31.15.31	
DW	MD	DDDDD	0 ~ 65535	

Wiring Diagram:

Ethernet cable:



LS XGK Cnet

Supported Series: LS XGT series XGK CPU with communication module XGL-CH2A

Website: <http://www.lgjs.com/>

HMI Setting:

Parameters	Recommended	Options	Notes
PLC type	LS XGK Cnet		
PLC I/F	RS232	RS232/RS485 4W	
Baud rate	115200	9600~115200	
Data bits	8	7, 8	
Parity	None	Even, Odd, None	
Stop bits	1	1	
PLC sta. no.	1	0 ~ 32	

Online simulator	YES	Pass-Through	YES
------------------	-----	--------------	-----

Device Address:

Bit/Word	Device type	Format	Range	Memo
B	PW_Bit	DDDDh	0 ~ 2047f	I/O device Bit
B	MW_Bit	DDDDh	0 ~ 2047f	Internal device Bit
B	LW_Bit	DDDDDh	0 ~ 11263f	Communication device Bit
B	KW_Bit	DDDDh	0 ~ 2559f	Preservation device Bit
B	FW_Bit	DDDDh	0 ~ 2047f	Special device Bit(write available from 1025)
B	DW_Bit	DDDDDh	0 ~ 32767f	Data register_Bit expression (D0000.0)
B	UW_Bit	DH.DDh	0 ~ 3f.31f	XGK-CPUE : hh(0~1f)
B	RW_Bit	DDDDDh	0 ~ 32767f	
B	ZRW_Bit	DDDDDh	0 ~ 32767f	
B	NW_Bit	DDDDDh	0 ~ 21503f	
B	ZW_Bit	DDDDh	0 ~ 127f	
B	SX	DDDDD	0 ~ 12799	Relay for step control Bit
B	TX	DDDD	0 ~ 2047	Timer device Bit
B	CX	DDDD	0 ~ 2047	Counter device Bit
W	PW	DDDD	0 ~ 2047	I/O device
W	MW	DDDD	0 ~ 2047	Internal device

Bit/Word	Device type	Format	Range	Memo
W	LW	DDDDD	0 ~ 11263	Communication device
W	KW	DDDD	0 ~ 2559	Preservation device
W	FW	DDDD	0 ~ 2047	Special device(write available from 1025)
W	DW	DDDDD	0 ~ 32767	Data register
W	UW	DH.DD	0.00 ~ 3f.31	Analog data register XGK-CPUE : hh(0~1f)
W	RW	DDDDD	0 ~ 32767	
W	ZRW	DDDDD	0 ~ 32767	
W	NW	DDDDD	0 ~ 21503	Communication data register
W	ZW	DDD	0 ~ 127	Index register_128 words
W	SW	DDDDD	0 ~ 127	Relay for step control
W	TW	DDDD	0 ~ 2047	Timer current value register
W	CW	DDDD	0 ~ 2047	Counter current value register

Wiring Diagram:

XGL-CH2A CH1 RS232 9P D-Sub Male (Diagram 1~Diagram 3)

Diagram 1

cMT Series

cMT3151

eMT Series

eMT3070 / eMT3105 / eMT3120 / eMT3150

MT-iE

MT8073iE / MT8102iE

MT-XE

MT8092XE

MT-iP

MT6103iP

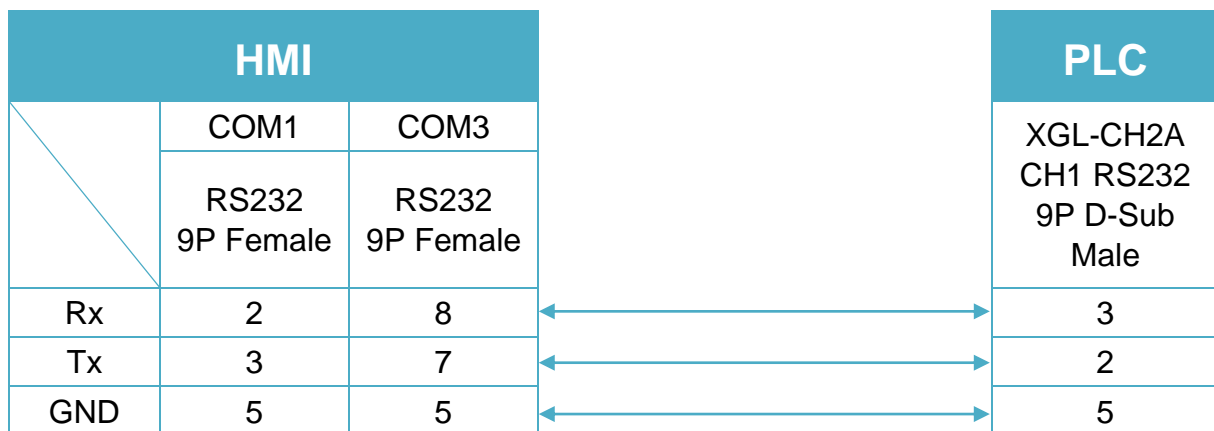


Diagram 2

cMT Series	cMT-SVR
mTV	mTV
MT-iE	MT8070iE / MT6070iE / MT8100iE / MT8121iE / MT8150iE / MT8071iE / MT6071iE / MT8072iE / MT6072iE / MT8073iE / MT8101iE / MT8102iE / MT8103iE
MT-XE	MT8121XE / MT8150XE / MT8090XE /

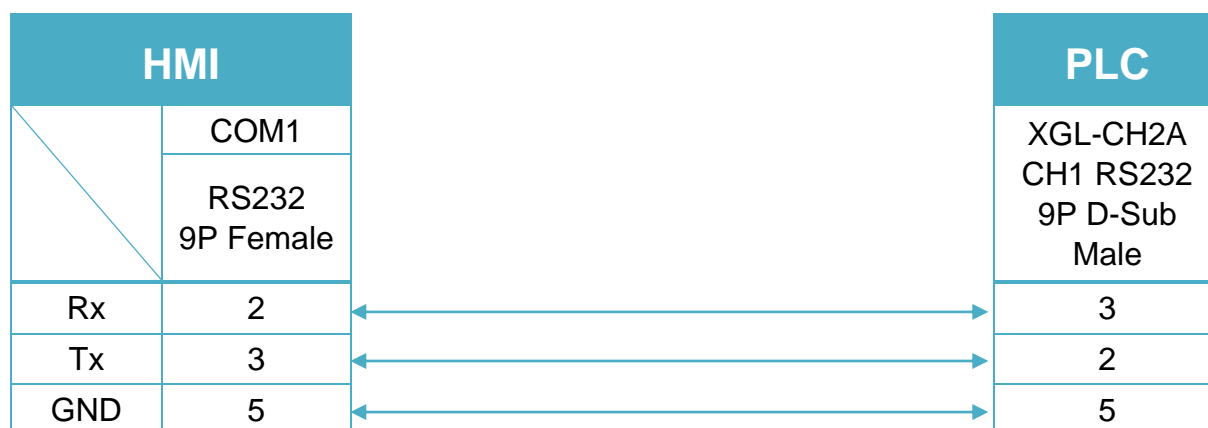
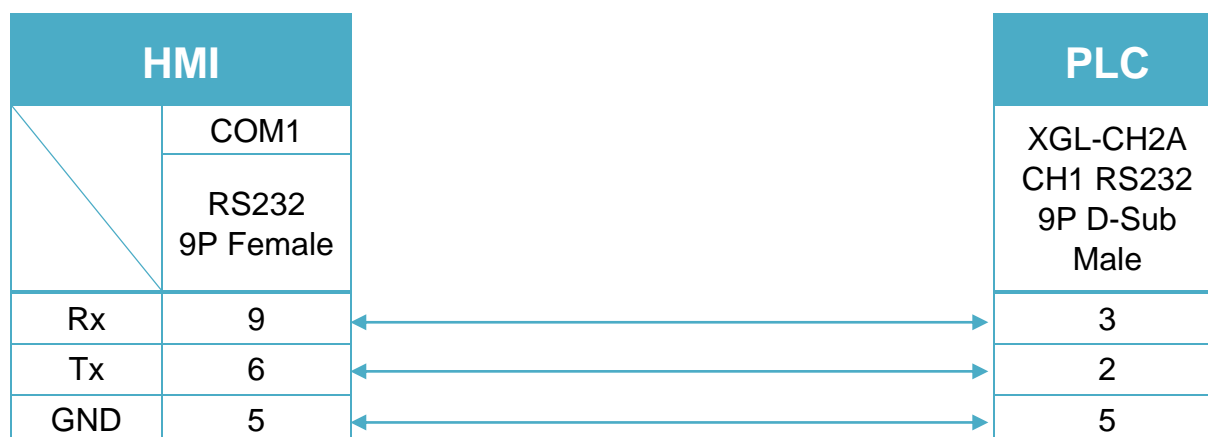


Diagram 3

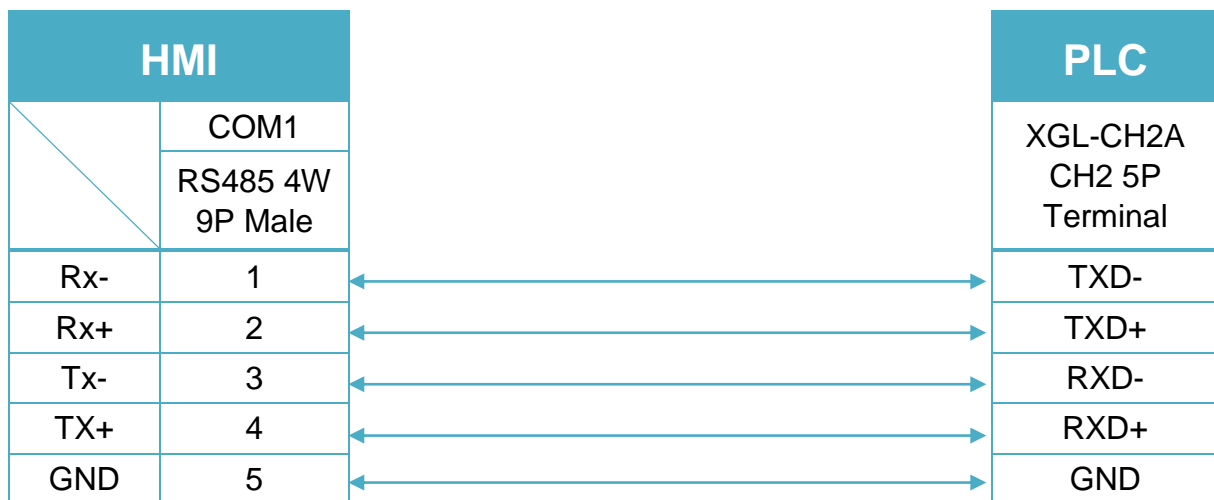
MT-iE	MT8050iE
MT-iP	MT6051iP / MT6071iP / MT8071iP



XGL-CH2A CH2 5P Terminal (Diagram 4 ~ Diagram 7)

Diagram 4

cMT Series	<i>cMT3151</i>
eMT Series	<i>eMT3070 / eMT3105 / eMT3120 / eMT3150</i>
MT-iE	<i>MT8070iE / MT6070iE / MT8100iE / MT8121iE / MT8150iE</i>
MT-XE	<i>MT8121XE / MT8150XE</i>


Diagram 5

cMT Series	<i>cMT-SVR</i>
mTV	<i>mTV</i>

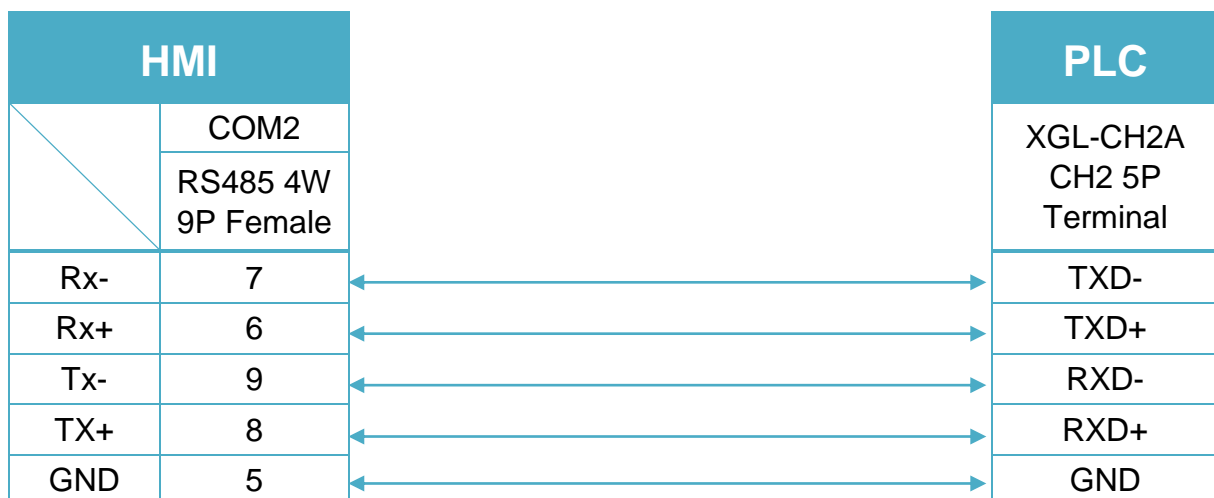


Diagram 6

MT-iE	<i>MT8071iE / MT6071iE / MT8072iE / MT6072iE / MT8073iE / MT8101iE / MT8102iE / MT8103iE</i>
MT-XE	<i>MT8090XE / MT8092XE</i>
MT-iP	<i>MT6071iP / MT8071iP / MT6103iP</i>

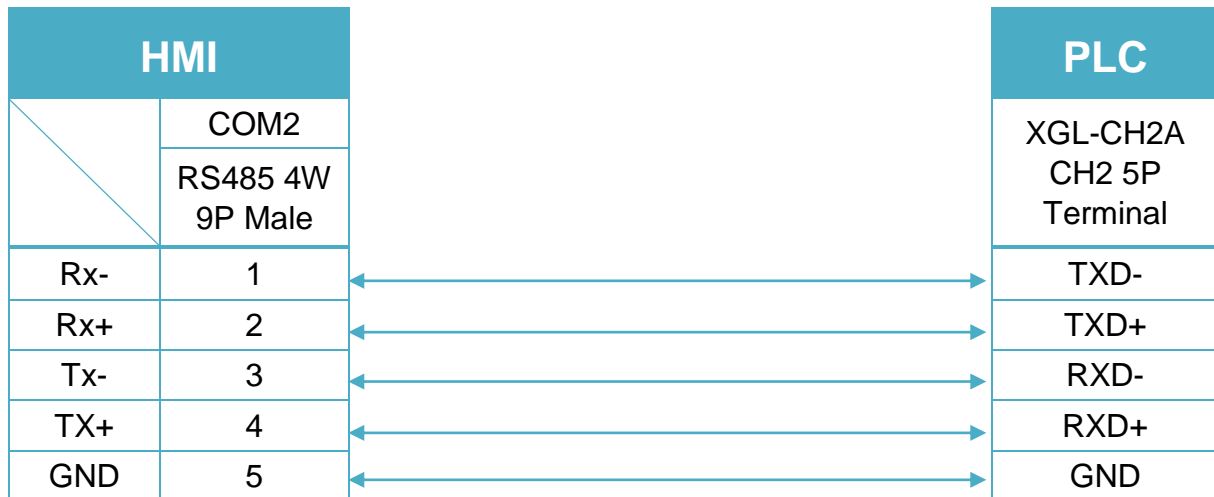
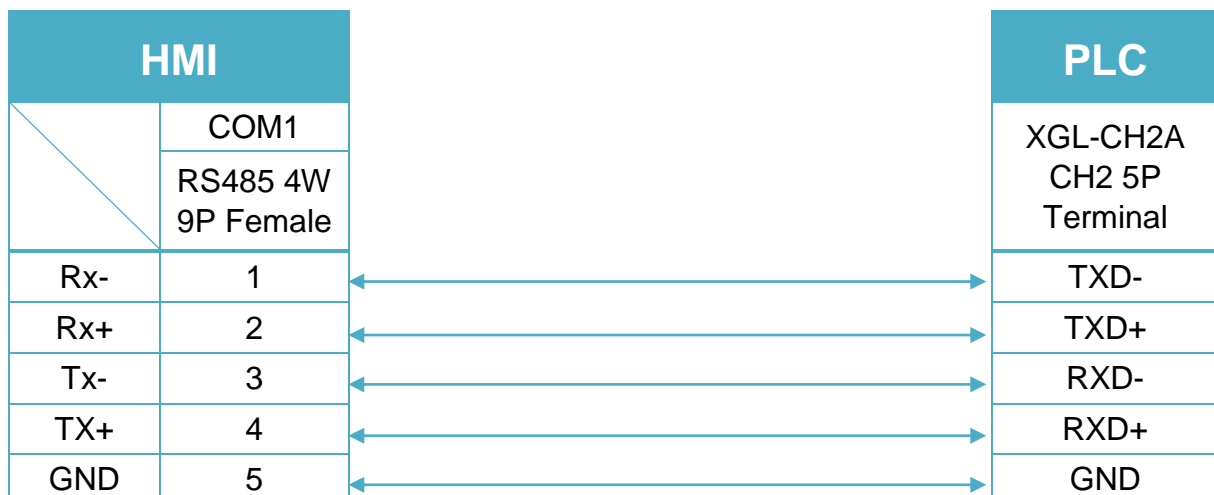


Diagram 7

MT-iE	<i>MT8050iE</i>
MT-iP	<i>MT6051iP</i>



LS XGK FEnet (Ethernet)

Supported Series: LS XGT series XGK CPU with XGL-EFMT Ethernet module.

Website: <http://www.lqis.com/>

HMI Setting:

Parameters	Recommended	Options	Notes
PLC type	LS XGK FEnet (Ethernet)		
PLC I/F	Ethernet		
Port no.	2004		

Device Address:

Bit/Word	Device type	Format	Range	Memo
B	PW_Bit	DDDDh	0 ~ 2047f	I/O device Bit
B	MW_Bit	DDDDh	0 ~ 2047f	Internal device Bit
B	LW_Bit	DDDDDh	0 ~ 11263f	Communication device Bit
B	KW_Bit	DDDDh	0 ~ 2559f	Preservation device Bit
B	FW_Bit	DDDDh	0 ~ 2047f	Special device Bit(write available from 1025)
B	SW_Bit	DDDDDh	0 ~ 12799	Relay for step control Bit
B	DW_Bit	DDDDDh	0 ~ 32767f	Data register_Bit expression (D0000.0)
B	UW_Bit	DH.DDh	0 ~ 3f.31f	XGK-CPUE : hh(0~1f)
B	RW_Bit	DDDDDh	0 ~ 32767f	
B	ZRW_Bit	DDDDDh	0 ~ 32767f	
B	NW_Bit	DDDDDh	0 ~ 21053f	
B	ZW_Bit	DDDh	0 ~ 127f	
B	TX	DDDD	0 ~ 2047	Timer device Bit
B	CX	DDDD	0 ~ 2047	Counter device Bit
W	PW	DDDD	0 ~ 2047	I/O device
W	MW	DDDD	0 ~ 2047	Internal device
W	LW	DDDDD	0 ~ 11263	Communication device
W	KW	DDDD	0 ~ 2559	Preservation device
W	FW	DDDD	0 ~ 2047	Special device(write available from 1025)
W	SW	DDDDD	0 ~ 127	Relay for step control
W	DW	DDDDD	0 ~ 32767	Data register
W	UW	DH.DD	0.00 ~ 3f.31	Analog data register XGK-CPUE : hh(0~1f)

Bit/Word	Device type	Format	Range	Memo
W	NW	DDDDD	0 ~ 21503	Communication data register
W	ZW	DDD	0 ~ 127	Index register_128 words
W	TW	DDDD	0 ~ 2047	Timer current value register
W	CW	DDDD	0 ~ 2047	Counter current value register
W	RW	DDDDD	0 ~ 32767	
W	ZRW	DDDDD	0 ~ 32767	

Wiring Diagram:

Ethernet cable:



LS Mecapion Metronix AnyPack

HMI Setting:

Parameters	Recommended	Options	Notes
PLC type	LS Mecapion Metronix AnyPack		
PLC I/F	RS232		
Baud rate	9600		
Data bits	8		
Parity	None		
Stop bits	1		
PLC sta. no.	0		

Device Address:

Bit/Word	Device Type	Format	Range	Memo
B	MX_L16bit	DDDDDDdd	0 ~ 9999915	MD Low 16bit
B	MX_H16bit	DDDDDDdd	0 ~ 9999915	MD High 16bit
DW	MD	DDDD	0 ~ 9999	

Wiring Diagram:

Diagram 1

cMT Series	<i>cMT3151</i>
eMT Series	<i>eMT3070 / eMT3105 / eMT3120 / eMT3150</i>
MT-iE	<i>MT8073iE / MT8102iE</i>
MT-XE	<i>MT8092XE</i>
MT-iP	<i>MT6103iP</i>

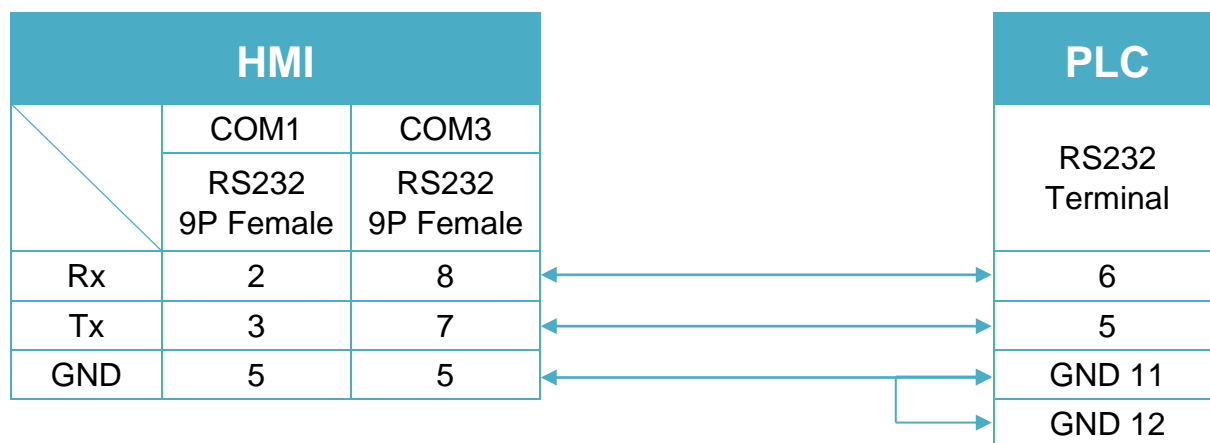


Diagram 2

cMT Series	cMT-SVR
mTV	mTV
MT-iE	MT8070iE / MT6070iE / MT8100iE / MT8121iE / MT8150iE / MT8071iE / MT6071iE / MT8072iE / MT6072iE / MT8073iE / MT8101iE / MT8102iE / MT8103iE
MT-XE	MT8121XE / MT8150XE / MT8090XE /

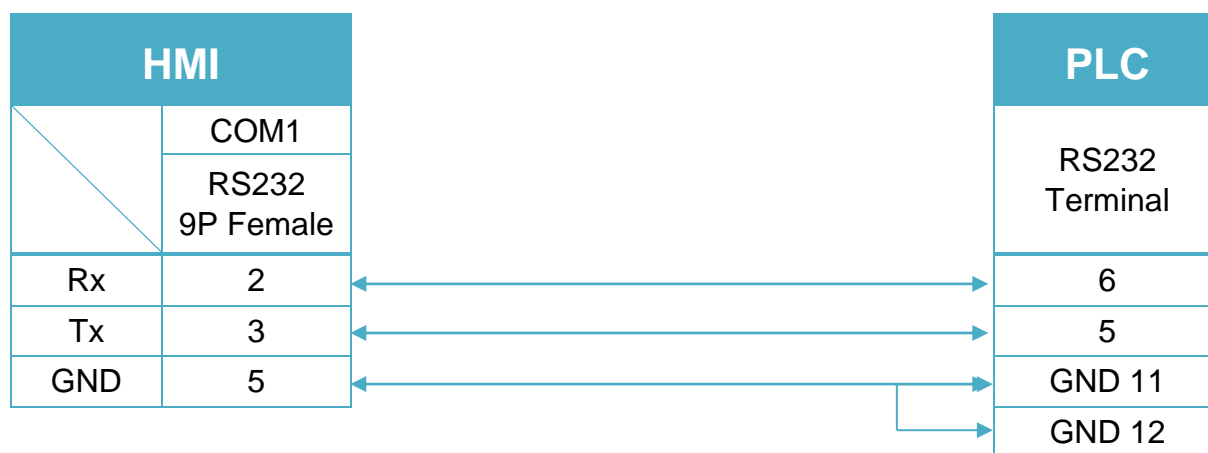
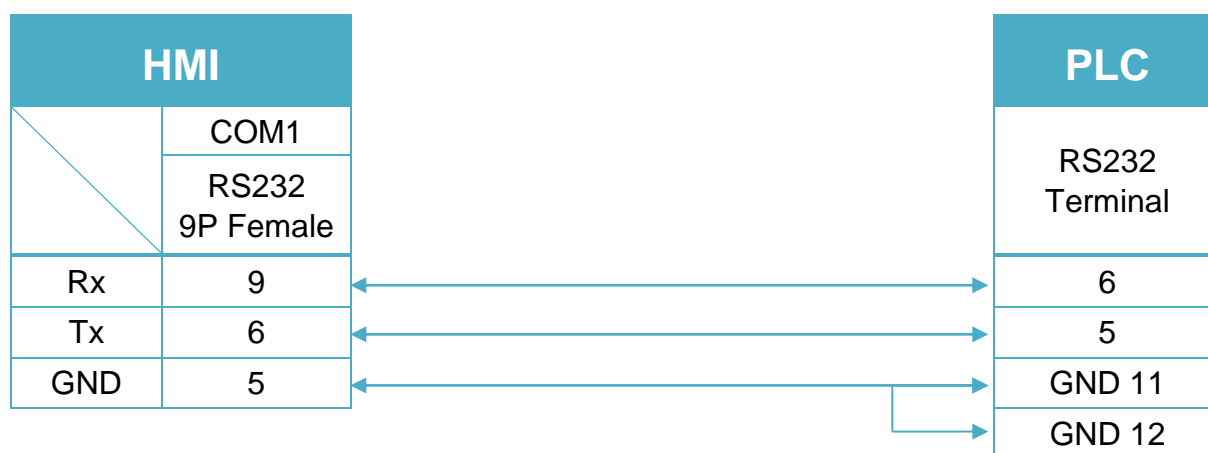


Diagram 3

MT-iE	MT8050iE
MT-iP	MT6051iP / MT6071iP / MT8071iP



LTi Motion LustBus

Supported Series: Lust Servo C SC3000 Series

HMI Setting:

Parameters	Recommended	Options	Notes
PLC type	LTi Motion LustBus		
PLC I/F	RS485 2W		
Baud rate	57600	9600 ~ 115200	
Data bits	7		
Parity	Even		
Stop bits	1		
PLC sta. no.	1	0 ~ 30	

Device Address:

Bit/Word	Device type	Format	Range	Memo
W	BYTE	DDD	0 ~ 999	
W	WORD	DDD	0 ~ 999	
W	DWORD	DDD	0 ~ 999	
W	FLOAT	DDD	0 ~ 999	
W	FIXPT16	DDD	0 ~ 999	32-bit float
W	INT32Q16	DDD	0 ~ 999	32-bit float
W	STRING	DDDdd	0 ~ 99900	dd:00
W	BYTE_Ary	DDDDDDDD	0 ~ 99965535	
W	WORD_Ary	DDDDDDDD	0 ~ 99965535	
W	DWORD_Ary	DDDDDDDD	0 ~ 99965535	
W	FLOAT_Ary	DDDDDDDD	0 ~ 99965535	
W	FIXPT16_Ary	DDDDDDDD	0 ~ 99965535	
W	INT32Q16_Ary	DDDDDDDD	0 ~ 99965535	
W	PT_MC_ERROR	DDDd	0 ~ 9990	d:0,1,2 *note1

*Note1: 0:error code (Word), 1:error point(Word), 2:work time(Double word)

Wiring Diagram:

RS485 2W Terminal (Diagram 1 ~ Diagram 6)

Diagram 1

cMT Series

cMT3151

eMT Series

eMT3070 / eMT3105 / eMT3120 / eMT3150

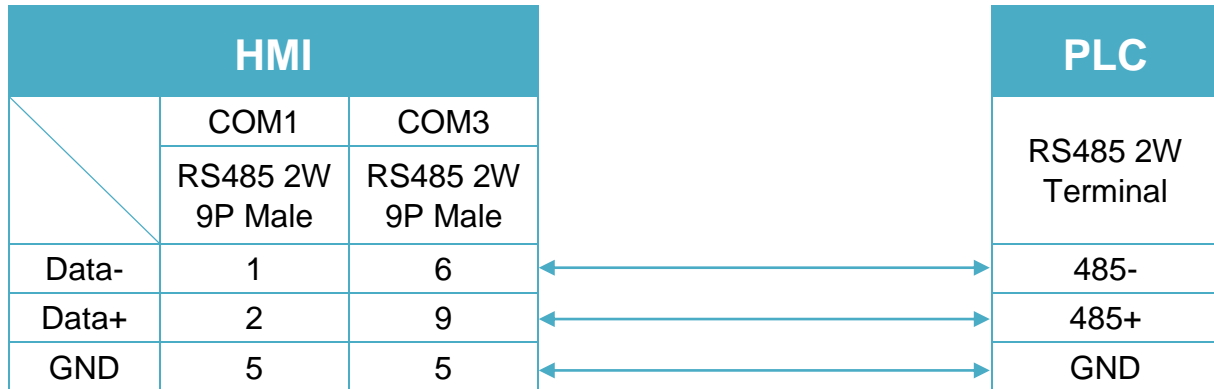


Diagram 2

cMT Series

cMT-SVR

mTV

mTV

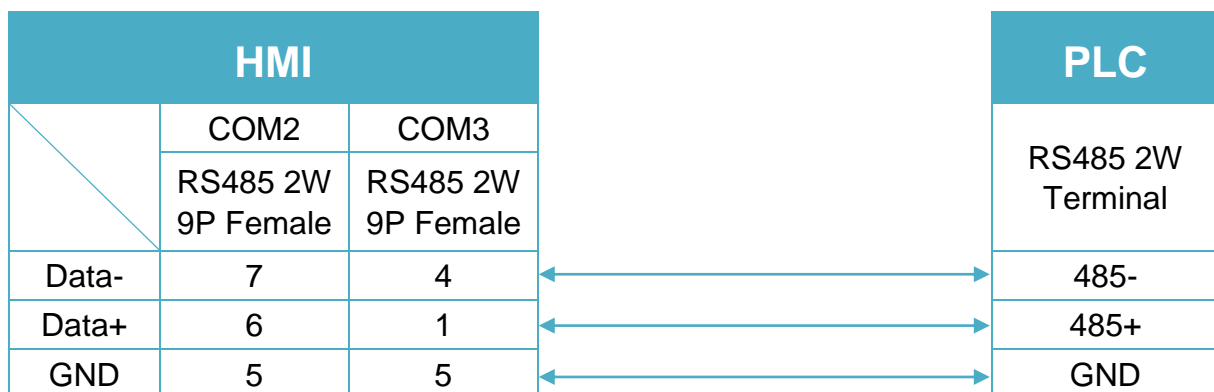


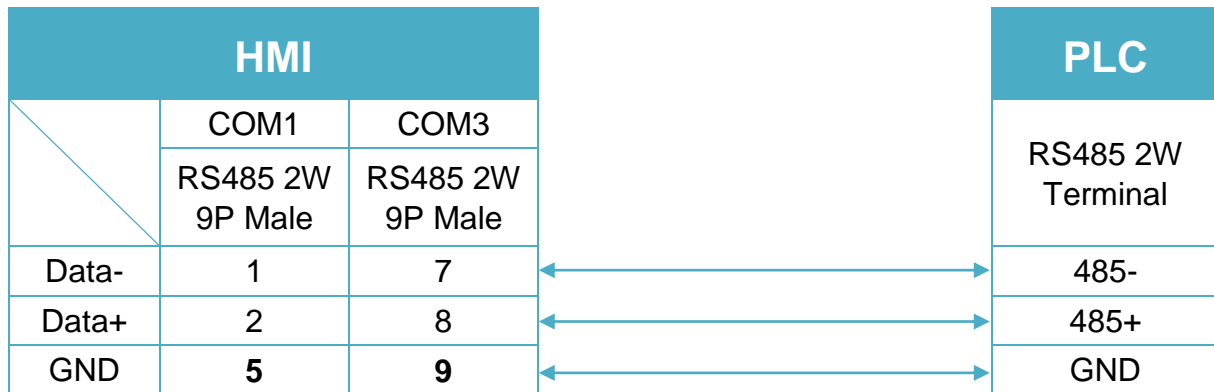
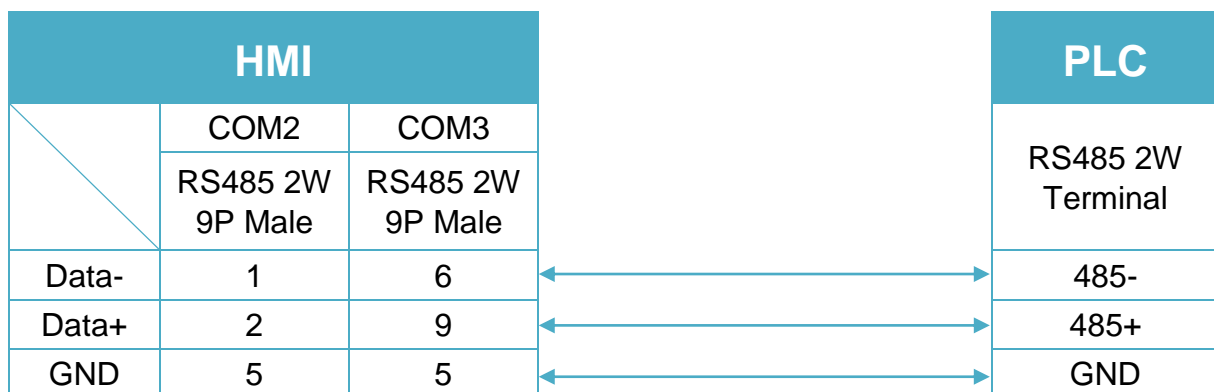
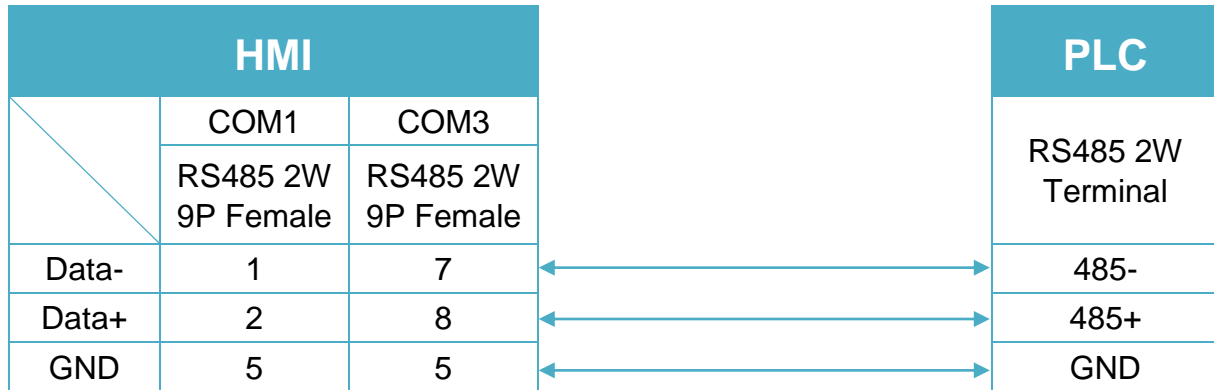
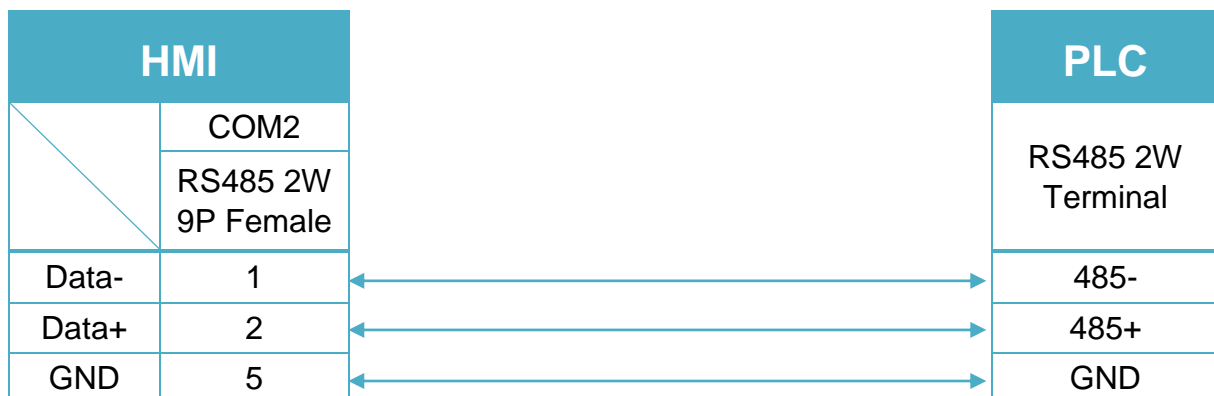
Diagram 3
MT-iE *MT8070iE / MT6070iE / MT8100iE / MT8121iE / MT8150iE*
MT-XE *MT8121XE / MT8150XE*

Diagram 4
MT-iE *MT8071iE / MT6071iE / MT8072iE / MT6072iE / MT8073iE / MT8101iE / MT8102iE / MT8103iE*
MT-XE *MT8090XE / MT8092XE*
MT-iP *MT6103iP*


Diagram 5
MT-iE *MT8050iE*
MT-iP *MT6051iP*

Diagram 6
MT-iP *MT6071iP / MT8071iP*


LTi Motion ServoOne (Ethernet)

Supported Series: Lust Servo One

HMI Setting:

Parameters	Recommended	Options	Notes
PLC type	LTi Motion ServoOne (Ethernet)		
PLC I/F	Ethernet		
Port no.	2317		

Device Address:

Bit/Word	Device type	Format	Range	Memo
B	BOOL	DDDDD	0 ~ 32767	
B	BOOL_Ary	DDDDDDDD	0 ~ 32767999	
W	INT8	DDDDD	0 ~ 32767	
W	UINT8	DDDDD	0 ~ 32767	
W	WORD	DDDDD	0 ~ 32767	
DW	DWORD	DDDDD	0 ~ 32767	
DW	FLOAT	DDDDD	0 ~ 32767	
W	STRING	DDDDDDDD	0 ~ 3276700	
W	INT8_Ary	DDDDDDDD	0 ~ 32767999	
W	UINT8_Ary	DDDDDDDD	0 ~ 32767999	
W	WORD_Ary	DDDDDDDD	0 ~ 32767999	
W	DWORD_Ary	DDDDDDDD	0 ~ 32767999	
W	FLOAT_Ary	DDDDDDDD	0 ~ 32767999	
W	STRING_Ary	DDDDDDDDDD	0 ~ 2147399900	

Wiring Diagram:

Ethernet cable:



Master-Slave Server

For more information, please refer to User's Manual CH28.

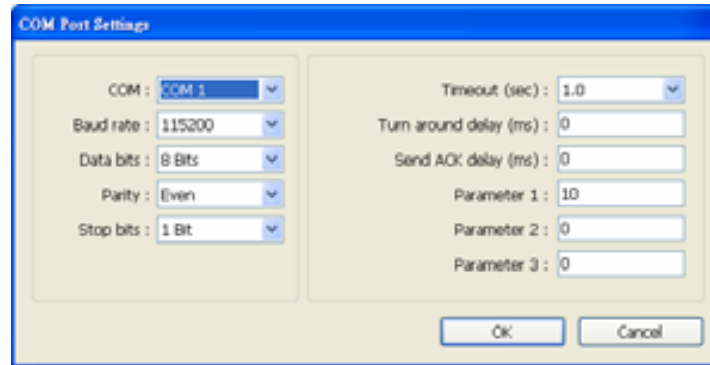
HMI Setting:

Parameters	Recommended	Options	Notes
PLC type	Master-Slave Server		
PLC I/F	RS232	RS232/RS485	
Baud rate	115200	9600~115200	
Data bits	8	7,8	
Parity	Even	None,Even,Odd,Mark,Space	
Stop bits	1	1,2	
HMI sta. no.	0		
PLC sta. no.	0		

FOR MT500 HMI Setting:

Parameters	Recommended	Options	Notes
PLC type	Master (Master-Slave Protocol)		
PLC I/F	RS232		
Baud rate	115200	38400, 115200	
Data bits	8		
Parity	Even		
Stop bits	1		
HMI sta. no.	0		
PLC sta. no.	0		
Parameter 1	MT500 PLC ID	Use PLCAddressView.exe to find PLC ID.	

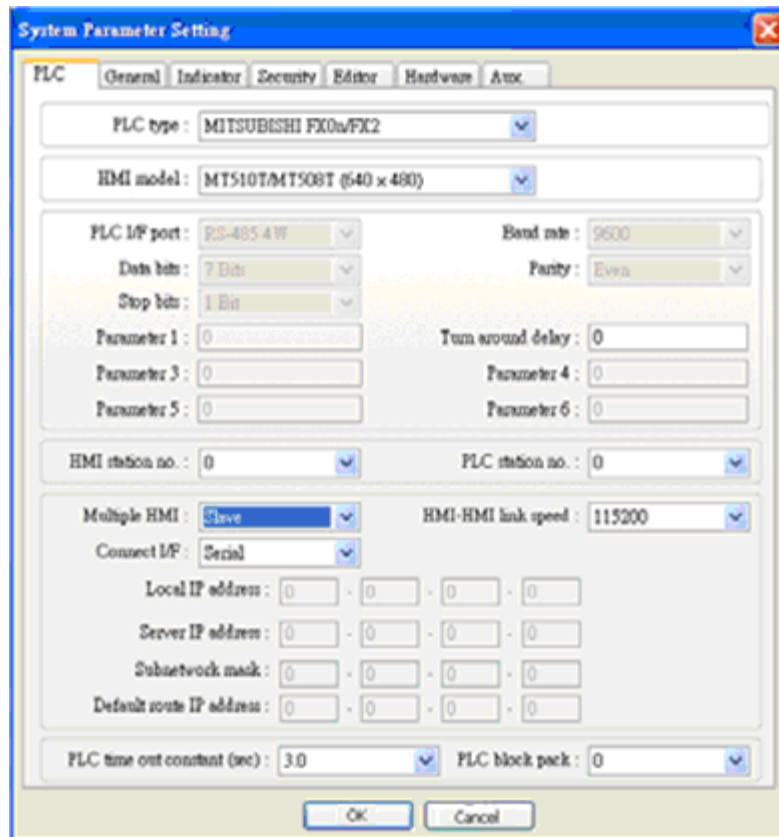
To connect HMI with MT500, MT500 has to be set as [Slave].

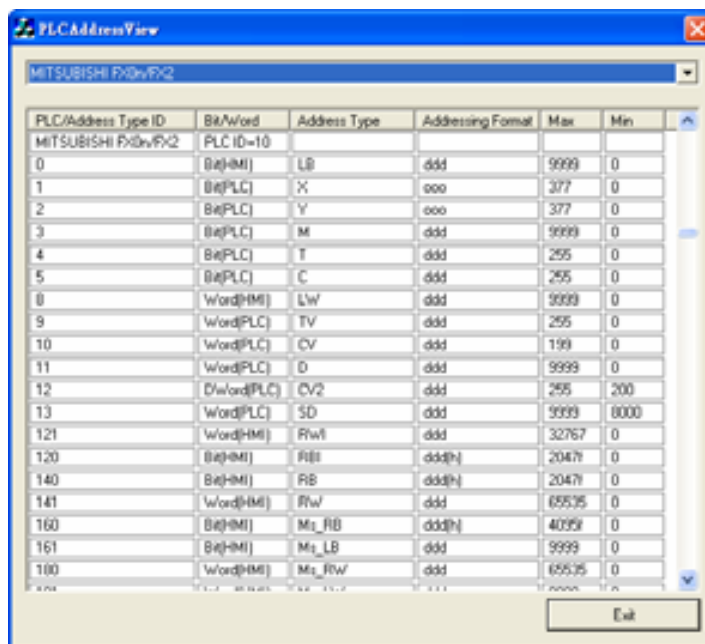


PLC Setting:

Communication mode

MT500 Multiple HMI set Slave.





PLC/Address Type ID	Bit/Word	Address Type	Addressing Format	Max	Min
MITSUBISHI FX2N-PC2	PLC ID=10				
0	Bit(HMI)	LB	ddd	9999	0
1	Bit(PLC)	X	ooo	377	0
2	Bit(PLC)	Y	ooo	377	0
3	Bit(PLC)	M	ddd	9999	0
4	Bit(PLC)	T	ddd	255	0
5	Bit(PLC)	C	ddd	255	0
8	Word(HMI)	LW	ddd	9999	0
9	Word(PLC)	TV	ddd	255	0
10	Word(PLC)	CV	ddd	199	0
11	Word(PLC)	D	ddd	9999	0
12	D/Word(PLC)	CV2	ddd	255	200
13	Word(PLC)	SD	ddd	9999	0000
121	Word(HMI)	RW	ddd	32767	0
120	Bit(HMI)	R[B]	ddd[h]	2047	0
140	Bit(HMI)	RB	ddd[h]	2047	0
141	Word(HMI)	RW	ddd	65535	0
160	Bit(HMI)	Ms_RB	ddd[h]	4095	0
161	Bit(HMI)	Ms_LB	ddd	9999	0
160	Word(HMI)	Ms_RW	ddd	65535	0

Device Address:

Bit/Word	MT500	MT8000	Range	Memo
B	Ms_RB	RW_Bit	dddd: 0 ~ 4095 (h): 0 ~ f	
B	Ms_LB	LB	dddd:0 ~ 9999	
W	Ms_RW	RW	dddd:0 ~ 65535	
W	Ms_LW	LW	dddd:0 ~ 9999	

MEGMEET MC Series

Supported Series: MEGMEET MC Series (Modbus RTU Protocol)

HMI Setting:

Parameters	Recommended	Options	Notes
PLC type	MEGMEET MC Series		
PLC I/F	RS232		
Baud rate	9600	9600, 19200, 115200	
Data bits	8	7 or 8	
Parity	Even	Even, Odd, None	
Stop bits	1	1 or 2	
PLC sta. no.	0	0-255	

PLC Setting:

Communication mode	Modbus RTU protocol
---------------------------	---------------------

Device Address:

Bit/Word	Device type	Format	Range	Memo
B	X	OOO	0 ~ 377	1200~01455 0000~0255
B	Y	OOO	0 ~ 377	0000~0255
B	M	DDDDD	0 ~ 10239	2000~2047 12000~20191
B	SM	DDD	0 ~ 511	4400~4655 30000~30255
B	S	DDDD	0 ~ 4095	6000~7023 31000~34071
B	T_Bit	DDD	0 ~ 511	8000~8255
B	C_Bit	DDD	0 ~ 306	9200~9455 10000~10050
B	D_Bit	DDDDdd	0 ~ 799915	
B	R_Bit	DDDDDDdd	0 ~ 3276715	
W	D	DDDD	0 ~ 7999	0000~7999
DW	D_Double	DDDD	0 ~ 7998	0000~7999
W	SD	DDD	0 ~ 511	8000~8255 12000~12255
DW	SD_Double	DDD	0 ~ 510	8000~8255 12000~12255
W	Z	DD	0 ~ 15	8500~8515
W	T	DDD	0 ~ 511	9000~9255 11000~11255
W	C	DDD	0 ~ 199	9500~9699

Bit/Word	Device type	Format	Range	Memo
DW	C_Double	DDD	200 ~ 306	9700~10101
W	R	DDDDD	0 ~ 32767	13000~45767
DW	R_Double	DDDDD	0 ~ 32766	13000~45767

Wiring Diagram:

Diagram 1

cMT Series	<i>cMT3151</i>
eMT Series	<i>eMT3070 / eMT3105 / eMT3120 / eMT3150</i>
MT-iE	<i>MT8073iE / MT8102iE</i>
MT-XE	<i>MT8092XE</i>
MT-iP	<i>MT6103iP</i>

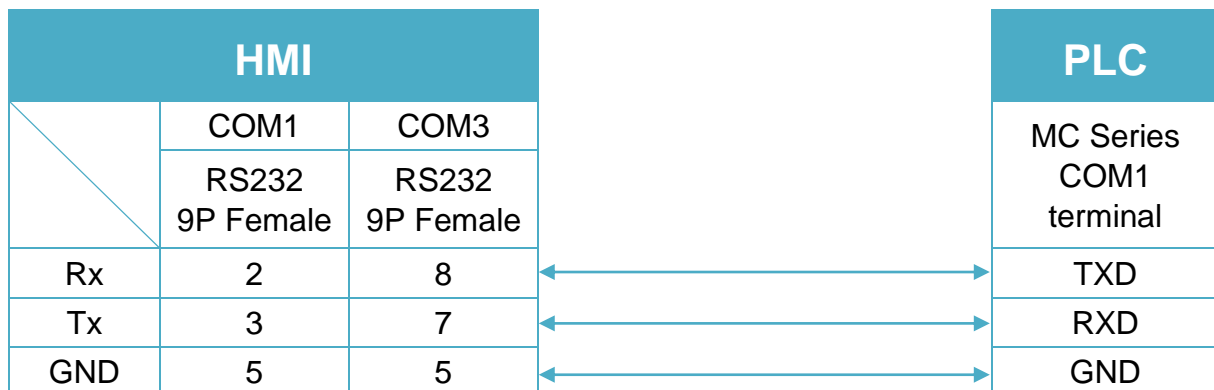


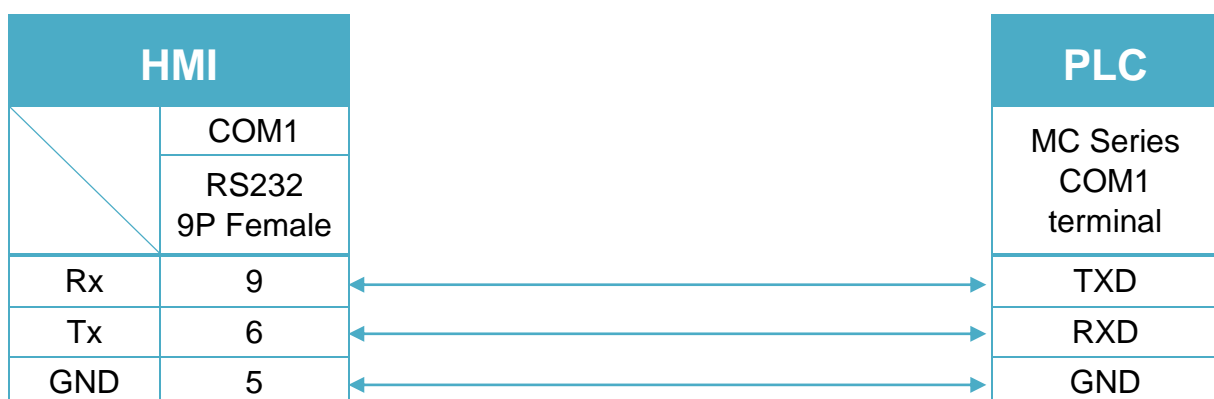
Diagram 2

cMT Series	cMT-SVR
mTV	mTV
MT-iE	MT8070iE / MT6070iE / MT8100iE / MT8121iE / MT8150iE / MT8071iE / MT6071iE / MT8072iE / MT6072iE / MT8073iE / MT8101iE / MT8102iE / MT8103iE
MT-XE	MT8121XE / MT8150XE / MT8090XE /



Diagram 3

MT-iE	MT8050iE
MT-iP	MT6051iP / MT6071iP / MT8071iP



MEIKONG Metro Safe Server

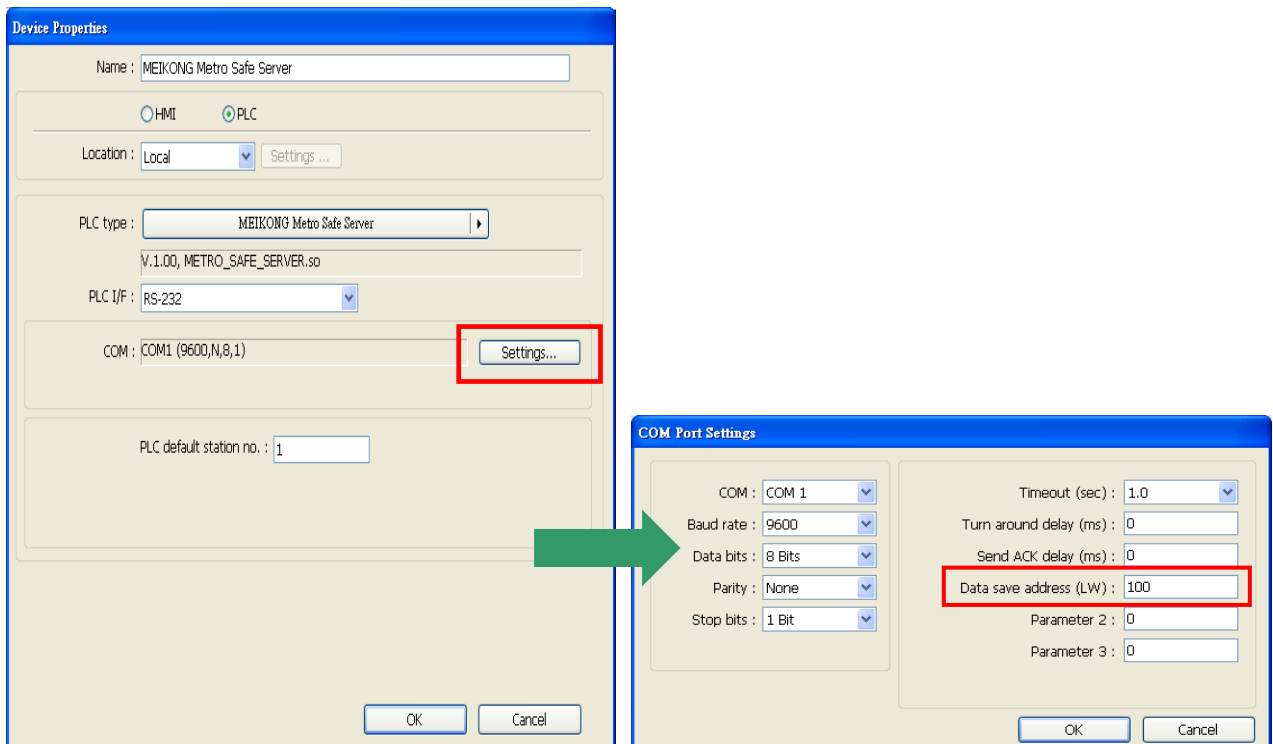
Supported Series: MEIKONG Metro Safe Server

Website: <http://www.xiemaowang.com/detail/2079110.html>

HMI Setting:

Parameters	Recommended	Options	Notes
PLC type	MEIKONG Metro Safe Server		
PLC I/F	RS4852W	RS232/RS485	
Baud rate	9600	9600~115200	
Data bits	8	7,8	
Parity	None	Even,Odd,None	
Stop bits	1	1,2	
PLC sta. no.	1	0~252	

In COM Port Settings, the data read will be stored in 25 consecutive addresses start from [Data save address (LW)] as shown below. Data will be stored in LW-100 to LW-124.



Protocol:

Byte	Description
0	AA
1	E0
2	C5 (The first 3 bytes are fixed, which represents the start of the message.)
3	Address (range 0-252)
4	Date-Year tens digit
5	Date-Year unit digit
6	Date-Month tens digit
7	Date-Month unit digit
8	Date-Day tens digit
9	Date-Day unit digit
10	Time-Hour tens digit
11	Time -Hour unit digit
12	Time -Minute tens digit
13	Time -Minute unit digit
14	Time -Second tens digit
15	Time -Second unit digit
16	1-Manual ; 2-Automatic
17	The number of slaves.
18	The sequence number of slave.
19	Slave status : 1-Normal ; 2-Warning ; 3-Emergency ; 4-Disconnected
20	Backup power : 1-normal ; 2-abnormal voltage ; 3- disconnect ; 4-short
21	00
22	00
23	EE
24	BB(The last 4 bytes are fixed, which represents the end of the message.)

Wiring Diagram:

RS232 (Diagram 1 ~ Diagram 3)

Diagram 1

cMT Series	<i>cMT3151</i>
eMT Series	<i>eMT3070 / eMT3105 / eMT3120 / eMT3150</i>
MT-iE	<i>MT8073iE / MT8102iE</i>
MT-XE	<i>MT8092XE</i>
MT-iP	<i>MT6103iP</i>

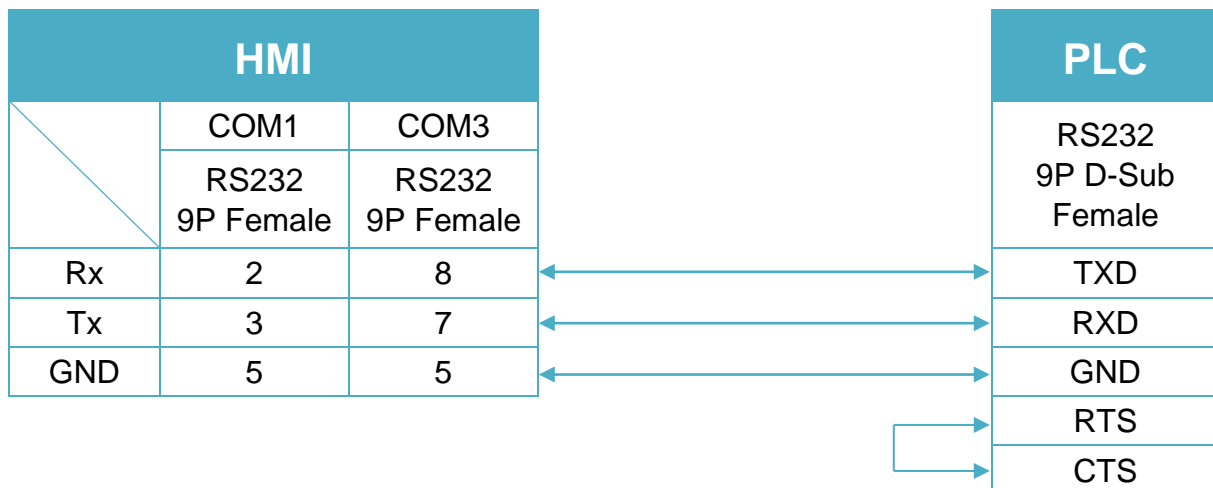


Diagram 2

cMT Series	cMT-SVR
mTV	mTV
MT-iE	MT8070iE / MT6070iE / MT8100iE / MT8121iE / MT8150iE / MT8071iE / MT6071iE / MT8072iE / MT6072iE / MT8073iE / MT8101iE / MT8102iE / MT8103iE
MT-XE	MT8121XE / MT8150XE / MT8090XE /

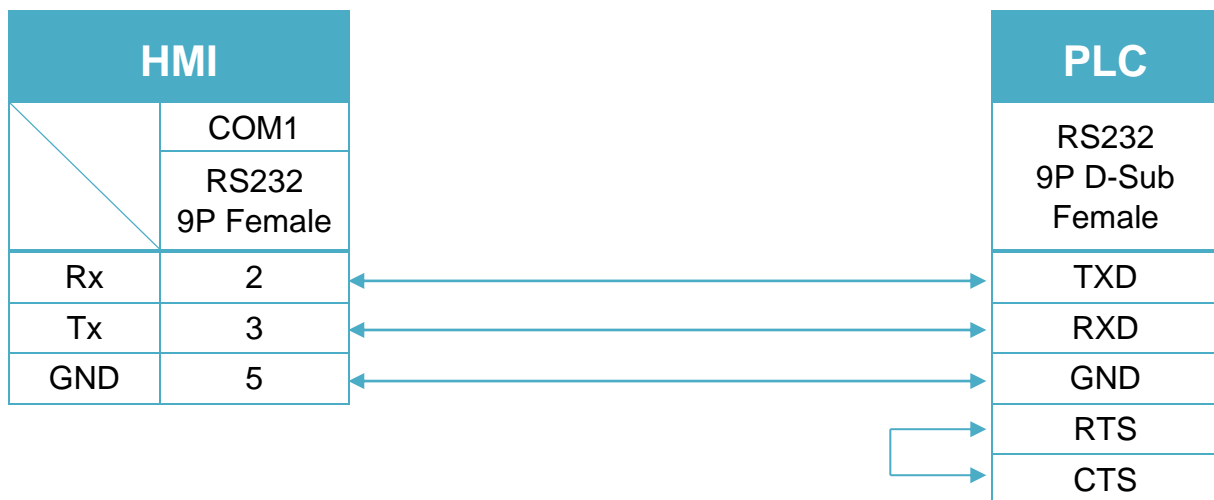
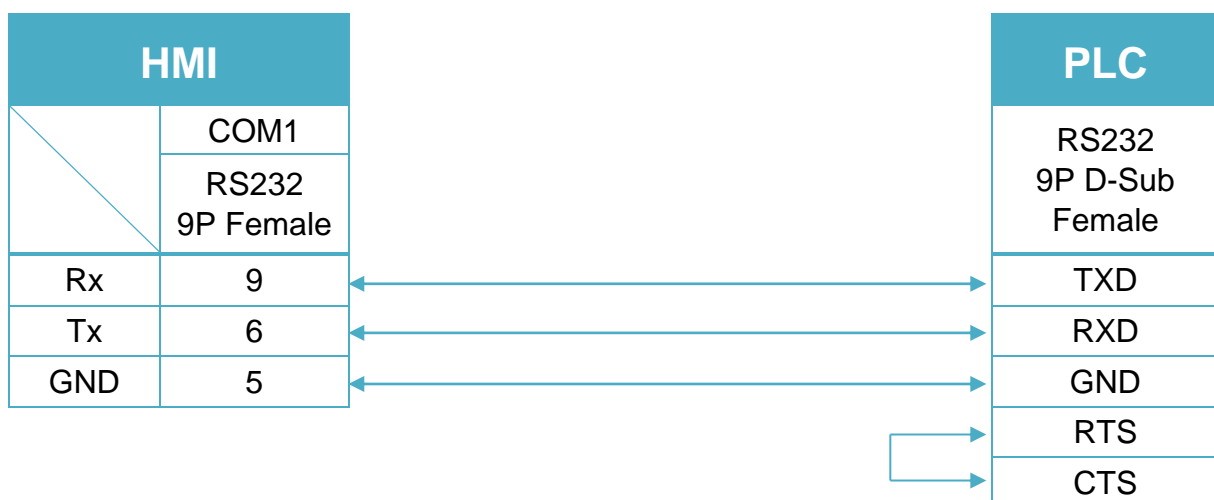


Diagram 3

MT-iE	MT8050iE
MT-iP	MT6051iP / MT6071iP / MT8071iP



RS485 4W (Diagram 4 ~ Diagram 7)

Diagram 4

cMT Series	<i>cMT3151</i>
eMT Series	<i>eMT3070 / eMT3105 / eMT3120 / eMT3150</i>
MT-iE	<i>MT8070iE / MT6070iE / MT8100iE / MT8121iE / MT8150iE</i>
MT-XE	<i>MT8121XE / MT8150XE</i>

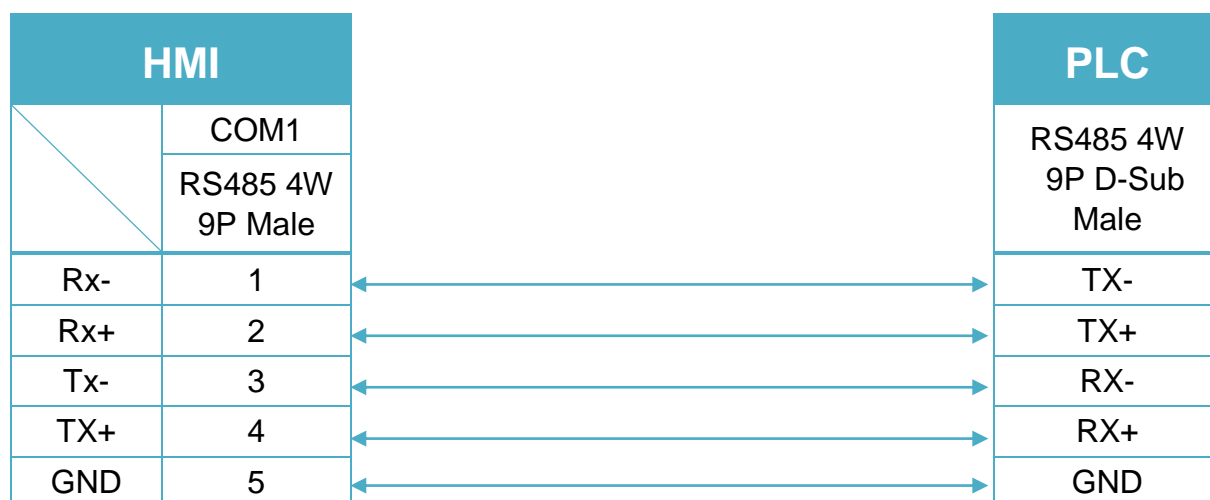


Diagram 5

cMT Series	<i>cMT-SVR</i>
mTV	<i>mTV</i>

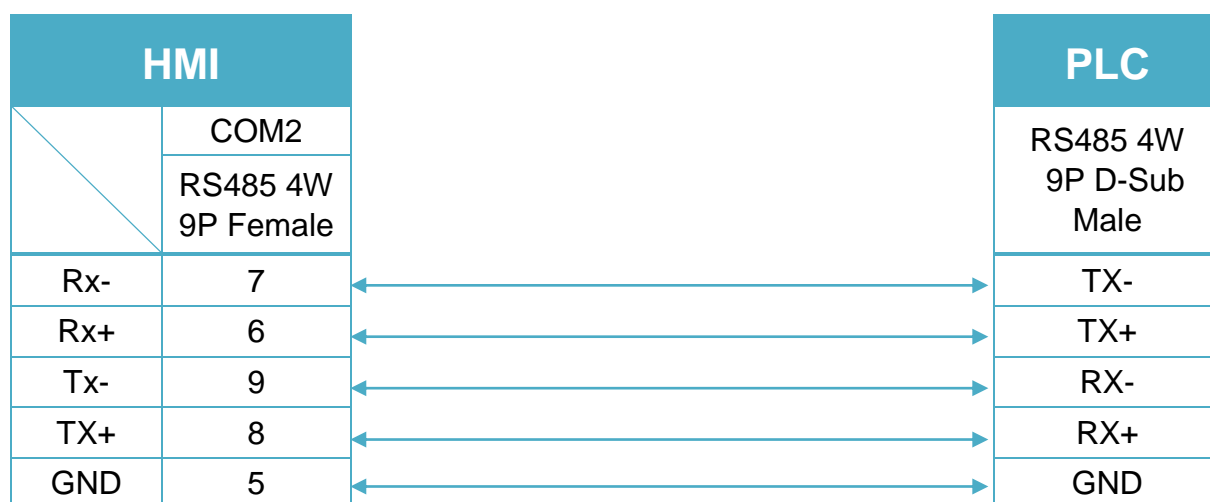


Diagram 6

MT-iE	<i>MT8071iE / MT6071iE / MT8072iE / MT6072iE / MT8073iE / MT8101iE / MT8102iE / MT8103iE</i>
MT-XE	<i>MT8090XE / MT8092XE</i>
MT-iP	<i>MT6071iP / MT8071iP / MT6103iP</i>

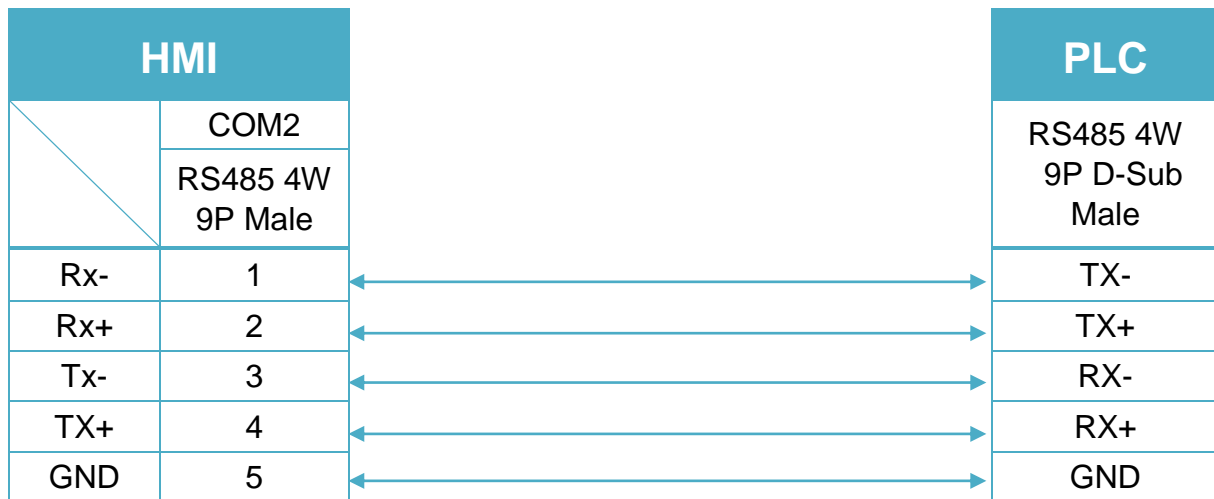
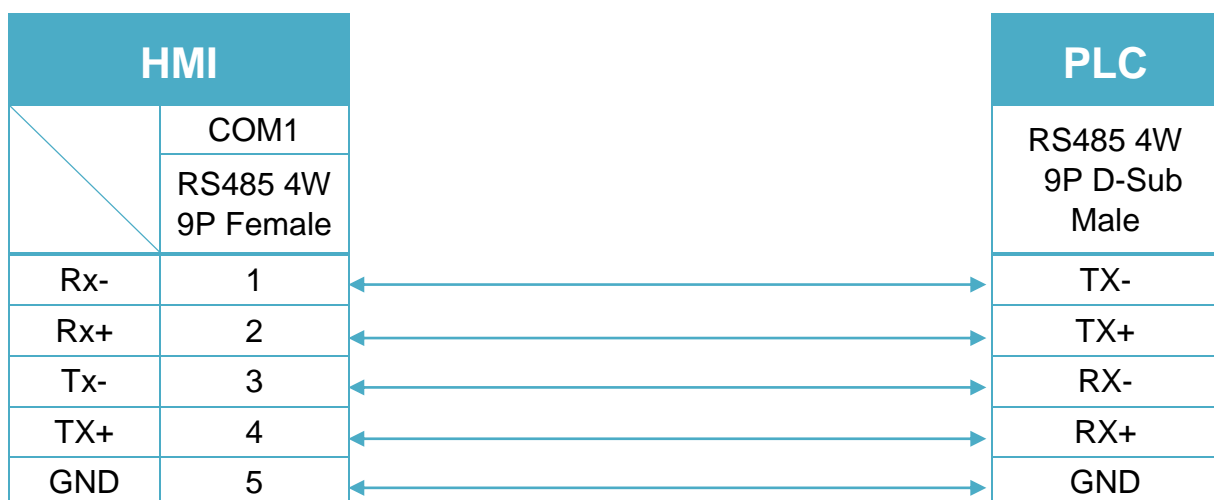


Diagram 7

MT-iE	<i>MT8050iE</i>
MT-iP	<i>MT6051iP</i>



RS485 2W (Diagram 8 ~ Diagram 13)

Diagram 8

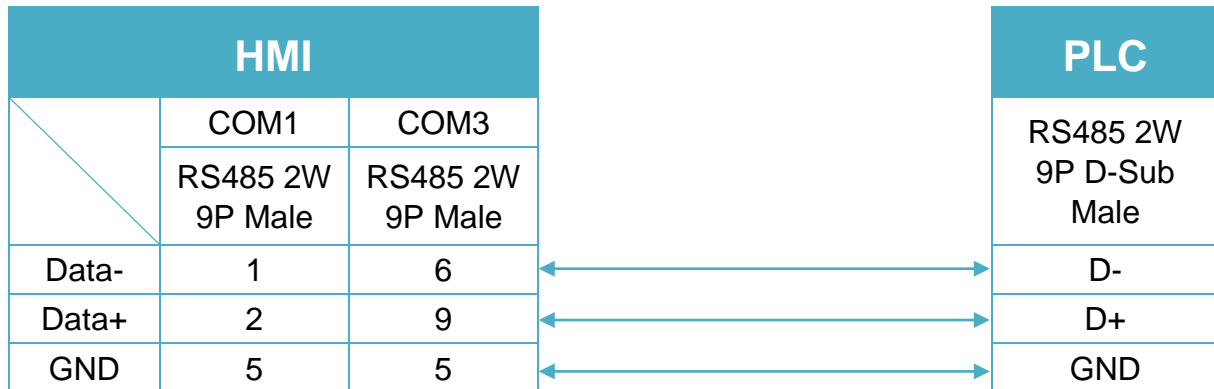
cMT Series *cMT3151*
eMT Series *eMT3070/ eMT3105 / eMT3120 / eMT3150*


Diagram 9

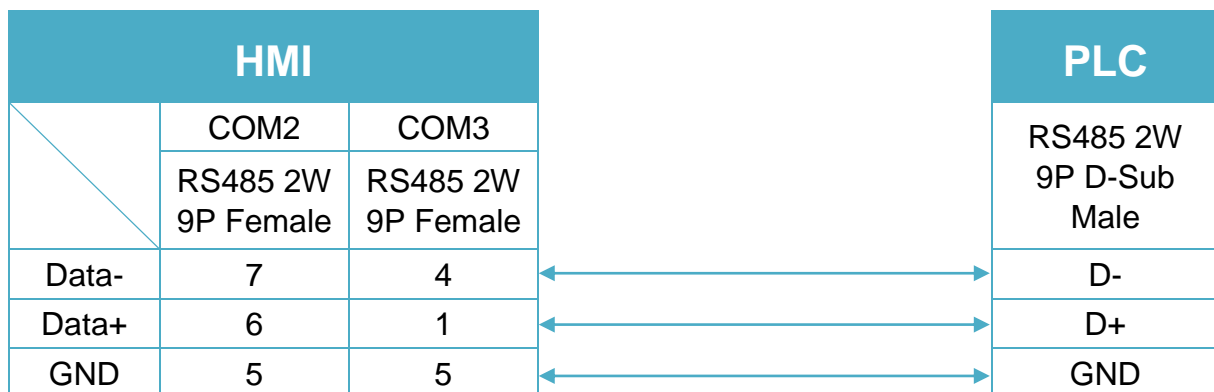
cMT Series *cMT-SVR*
mTV *mTV*


Diagram 10

MT-iE *MT8070iE / MT6070iE / MT8100iE / MT8121iE / MT8150iE*

MT-XE *MT8121XE / MT8150XE*

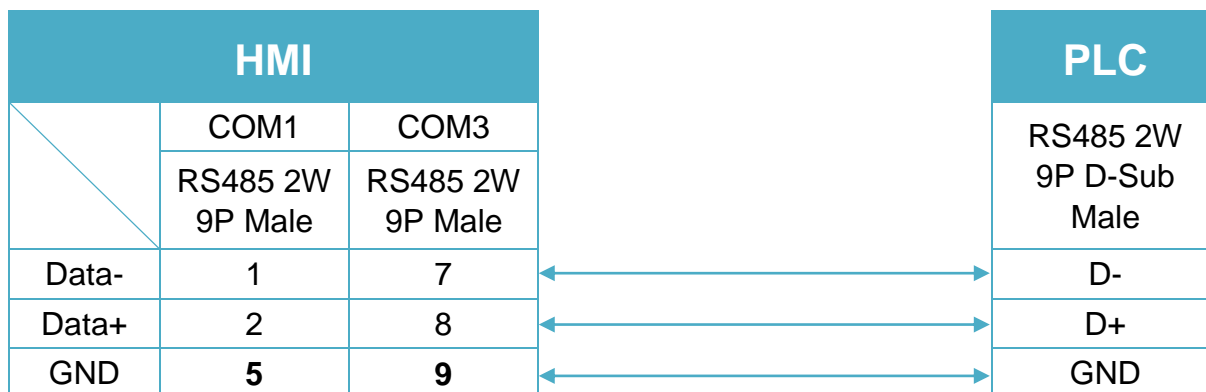


Diagram 11

MT-iE *MT8071iE / MT6071iE / MT8072iE / MT6072iE / MT8073iE /
MT8101iE / MT8102iE / MT8103iE*

MT-XE *MT8090XE / MT8092XE*

MT-iP *MT6103iP*

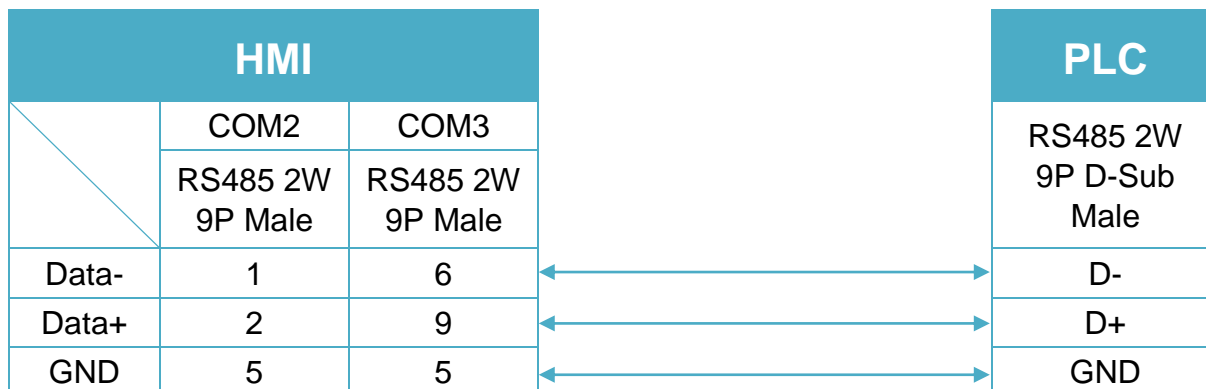


Diagram 12

MT-iE *MT8050iE*

MT-iP *MT6051iP*

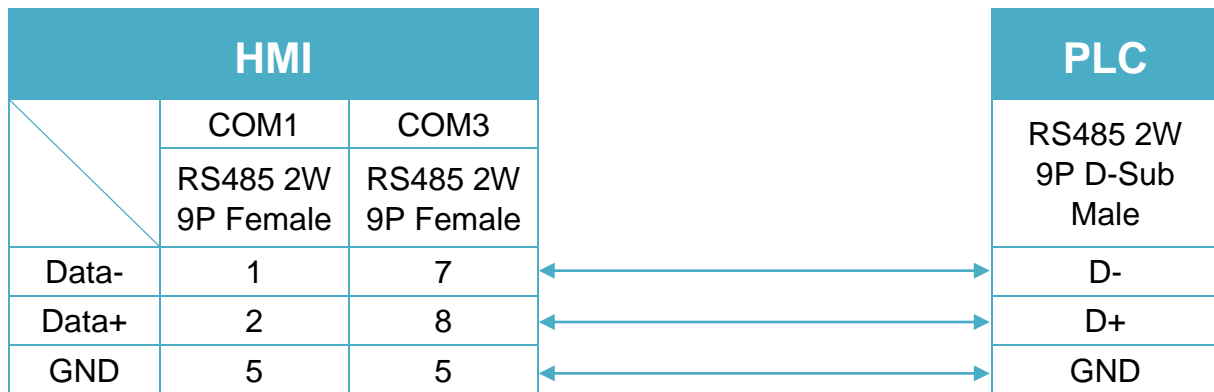
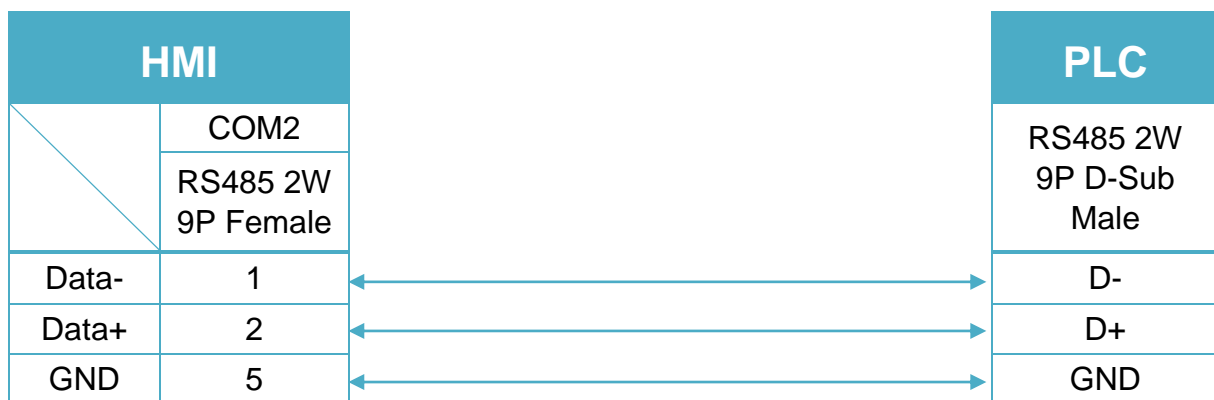


Diagram 13

MT-iP *MT6071iP / MT8071iP*



Memory Map

Memory Map protocol is similar to IBM 3764R communication protocol. EasyBuilder reserves 512 words of data memory to use with this protocol. EasyBuilder must update the values in these words. EasyBuilder uses these words to display data and control parts status on screen. When touch actions are taken, data is sent to the others once, and then update the memory in it. The HMI should always update the data memory.

HMI Setting:

Parameters	Recommend	Options	Notes
PLC type	Memory Map		
PLC I/F	RS232	RS232, RS485 4W, 2W	RS232 default
Baud rate	115200	9600~115200	
Data bits	8		
Parity	Even	Even, Odd, None	
Stop bits	1		

Device Address:

Bit/Word	Device type	Format	Range	Memo
B	MB	DDDDh	0 ~ 4095f	
W	MW	DDDD	0 ~ 9999	

MB and MW share the same data storage.

MW 0 = MB 00000 ~ MB 0000f, MW 1 = MB 00010 ~ MB 0001f

Wiring Diagram:

RS232 (Diagram 1 ~ Diagram 3)

Diagram 1

cMT Series	<i>cMT3151</i>
eMT Series	<i>eMT3070 / eMT3105 / eMT3120 / eMT3150</i>
MT-iE	<i>MT8073iE / MT8102iE</i>
MT-XE	<i>MT8092XE</i>
MT-iP	<i>MT6103iP</i>

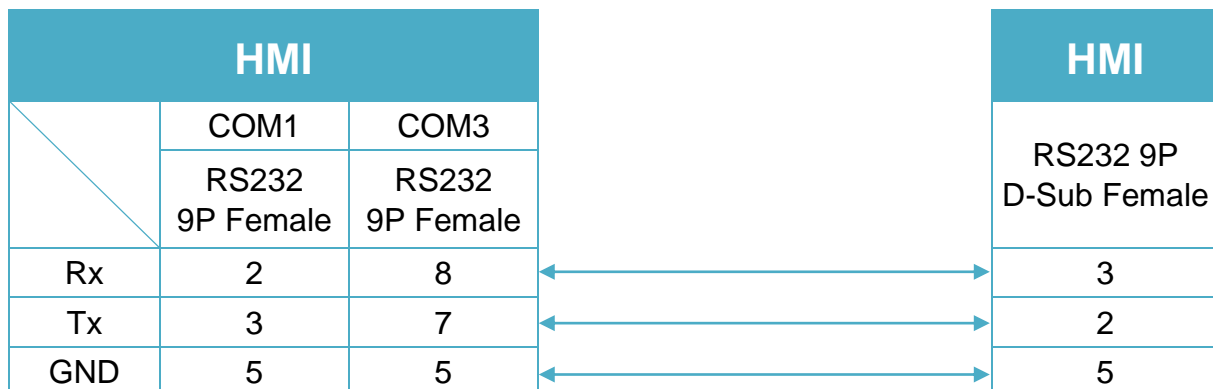


Diagram 2

cMT Series	<i>cMT-SVR</i>
mTV	<i>mTV</i>
MT-iE	<i>MT8070iE / MT6070iE / MT8100iE / MT8121iE / MT8150iE / MT8071iE / MT6071iE / MT8072iE / MT6072iE / MT8073iE / MT8101iE / MT8102iE / MT8103iE</i>
MT-XE	<i>MT8121XE / MT8150XE / MT8090XE /</i>

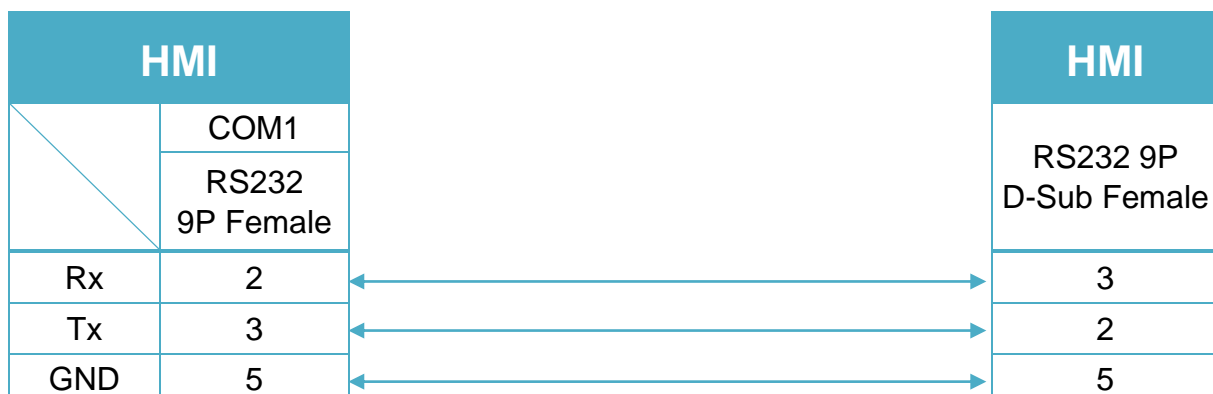


Diagram 3

MT-iE *MT8050iE*

MT-iP *MT6051iP / MT6071iP / MT8071iP*



RS485 2W (Diagram 4 ~ Diagram 9)

Diagram 4

cMT Series *cMT3151*

eMT Series *eMT3070/ eMT3105 / eMT3120 / eMT3150*

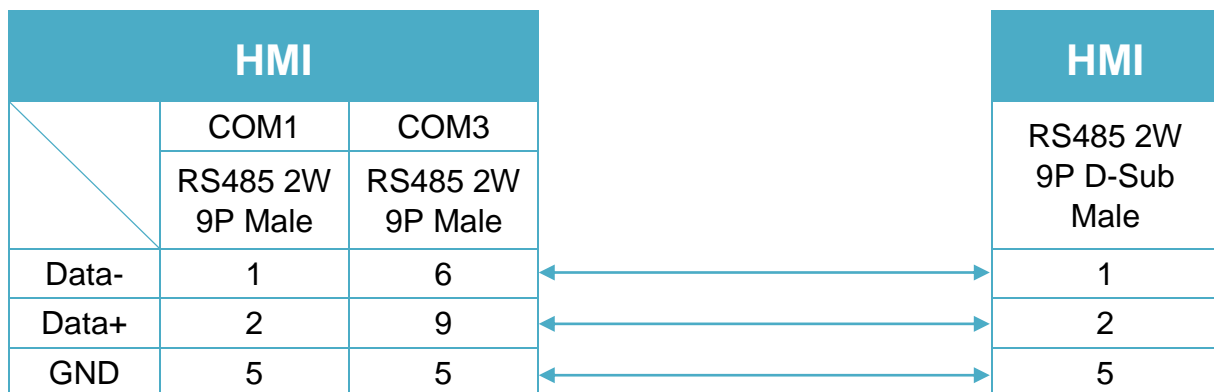


Diagram 5

cMT Series *cMT-SVR*

mTV *mTV*

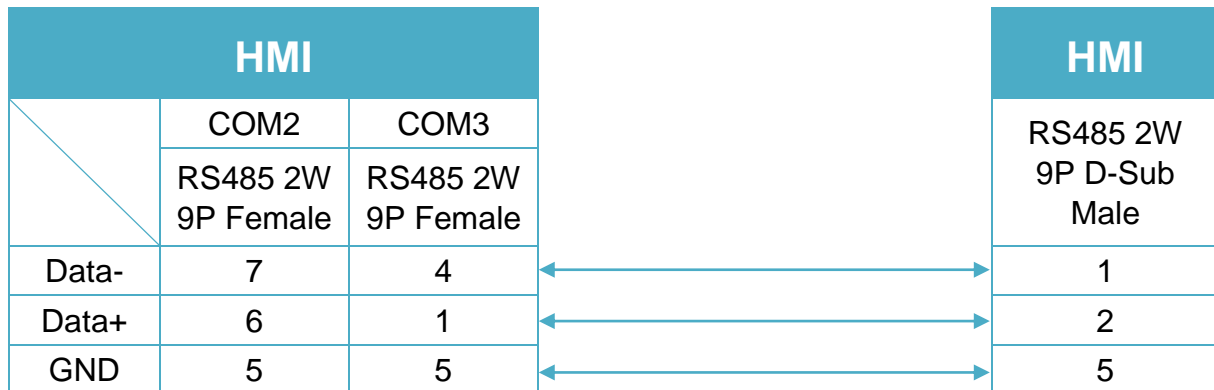


Diagram 6

MT-iE *MT8070iE / MT6070iE / MT8100iE / MT8121iE / MT8150iE*

MT-XE *MT8121XE / MT8150XE*

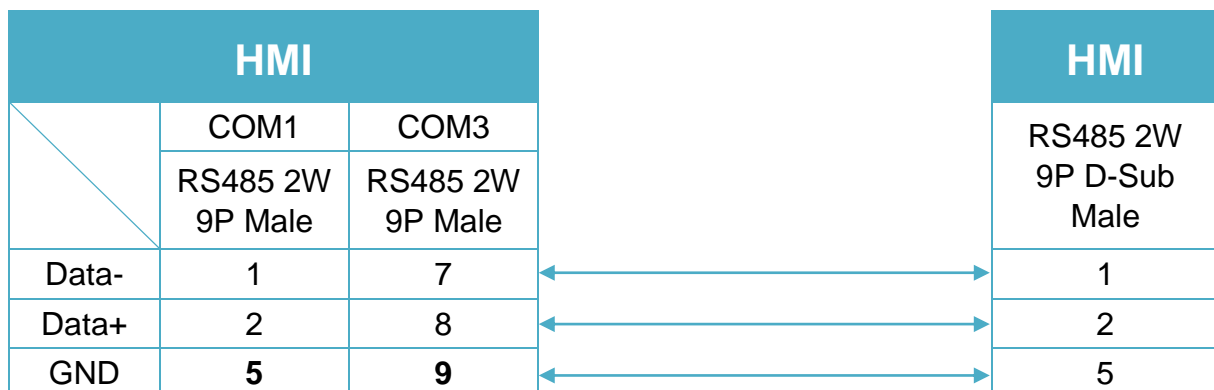


Diagram 7

MT-iE	<i>MT8071iE / MT6071iE / MT8072iE / MT6072iE / MT8073iE / MT8101iE / MT8102iE / MT8103iE</i>
MT-XE	<i>MT8090XE / MT8092XE</i>
MT-iP	<i>MT6103iP</i>

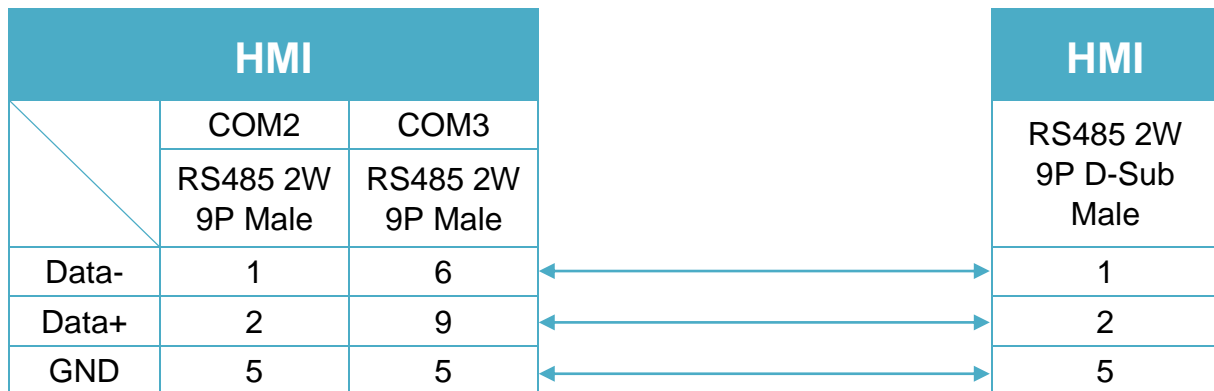


Diagram 8

MT-iE	<i>MT8050iE</i>
MT-iP	<i>MT6051iP</i>

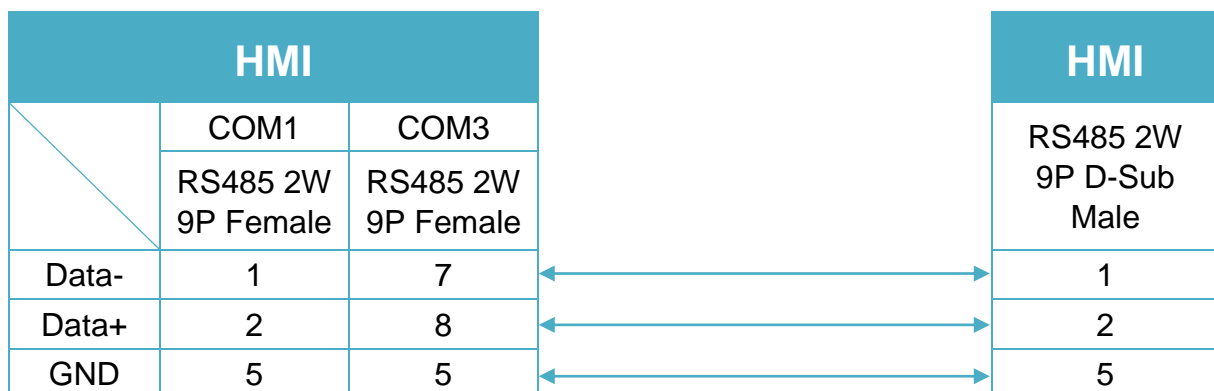
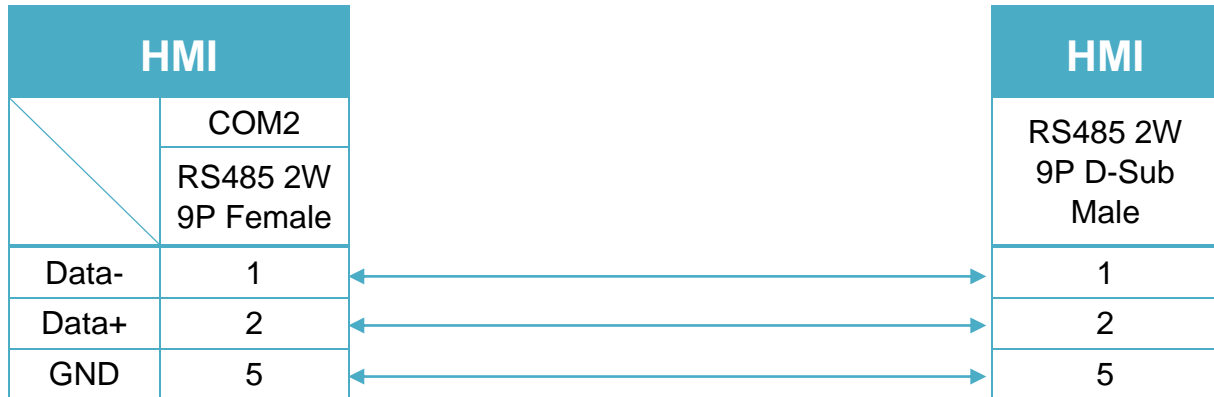


Diagram 9

MT-iP *MT6071iP / MT8071iP*



RS485 4W (Diagram 10 ~ Diagram 13)

Diagram 10

cMT Series *cMT3151*

eMT Series *eMT3070 / eMT3105 / eMT3120 / eMT3150*

MT-iE *MT8070iE / MT6070iE / MT8100iE / MT8121iE / MT8150iE*

MT-XE *MT8121XE / MT8150XE*

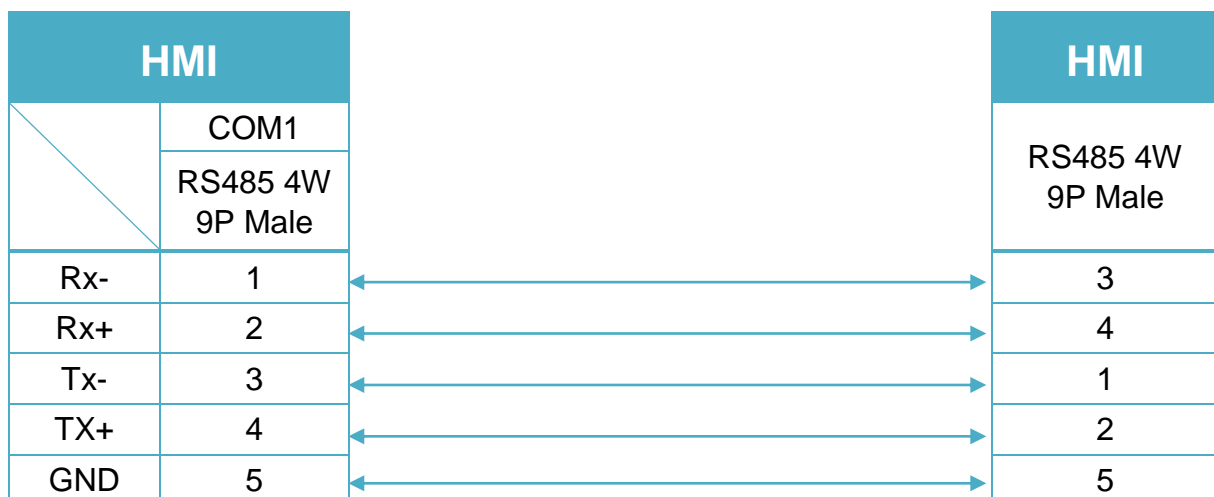


Diagram 11

cMT Series *cMT-SVR*

mTV *mTV*

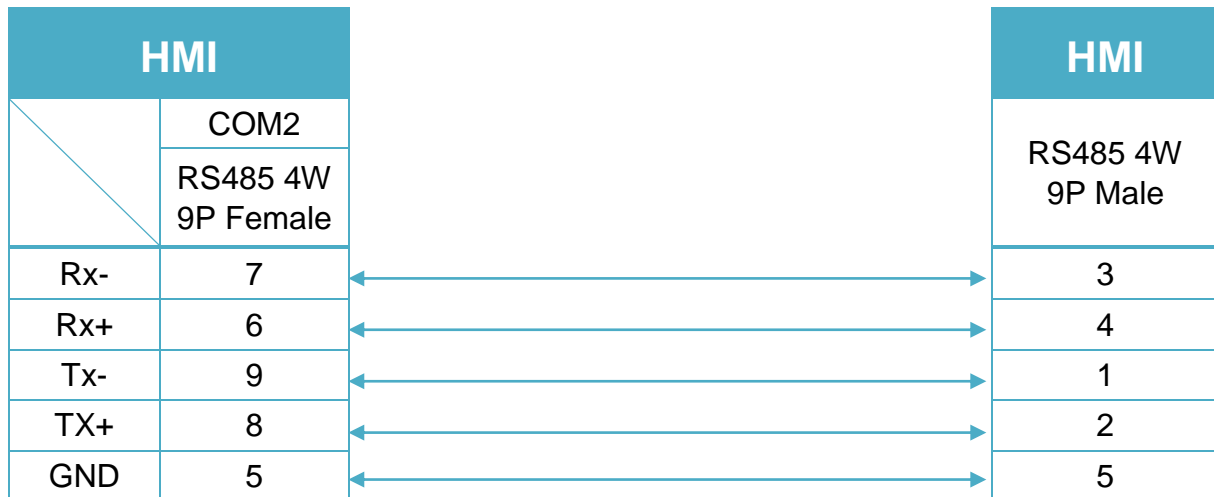


Diagram 12

MT-iE *MT8071iE / MT6071iE / MT8072iE / MT6072iE / MT8073iE /
MT8101iE / MT8102iE / MT8103iE*

MT-XE *MT8090XE / MT8092XE*

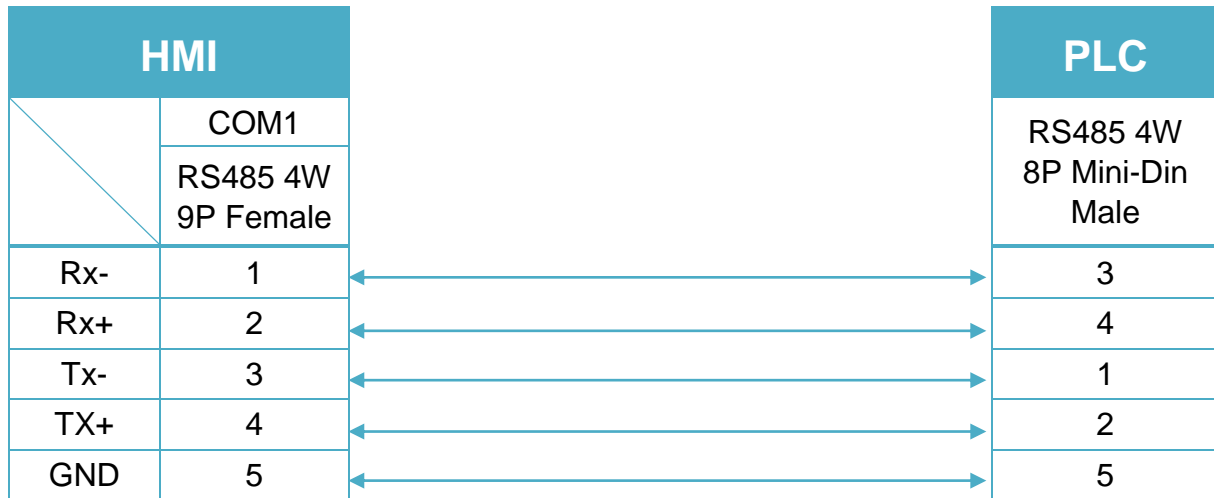
MT-iP *MT6071iP / MT8071iP / MT6103iP*



Diagram 13

MT-iE *MT8050iE*

MT-iP *MT6051iP*



Note:

For Memory map information, please refer to User's Manual "Chapter 31 Memory Map Communication".

MIKOM MX Series PLC

Support series: MIKOM MX series PLC

Web: <http://www.mikom.com.cn/>

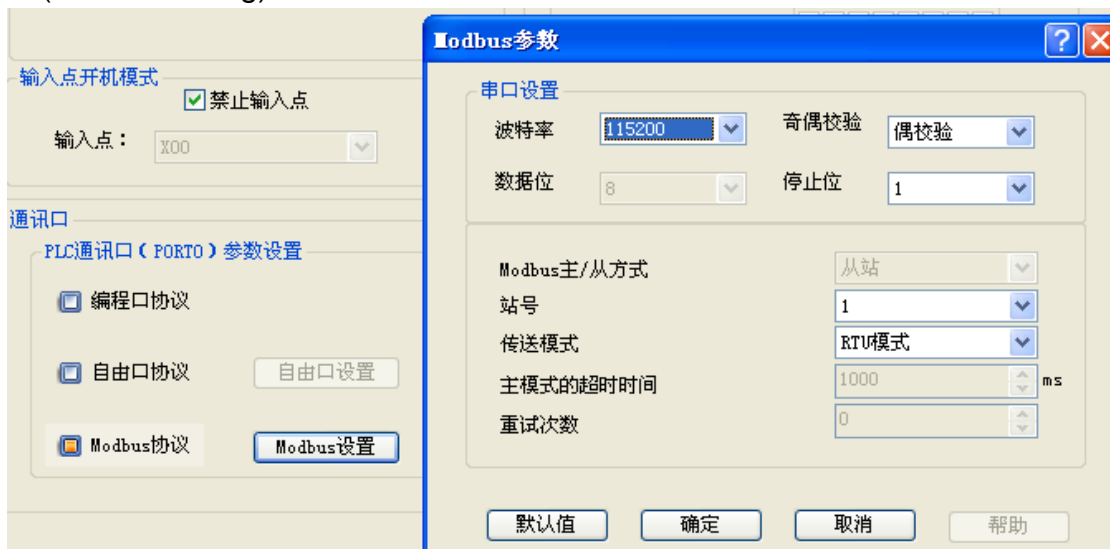
HMI Setting:

Parameters	Recommended	Options	Notes
PLC type	MIKOM MX Series PLC		
PLC I/F	RS232	RS232/485/Ethernet	
Baud rate	19200	9600~115200	
Data bits	Even	None,Even,Odd	
Parity	8	8	
Stop bits	1	1,2	
PLC sta. no.	1	0~31	

Online simulator	YES
------------------	-----

PLC Setting:

PORT 0(RS232 Setting)



PORT 1(RS485 Setting)



Device Address:

Bit/Word	Device type	Format	Range	Memo
B	Y	DDD	0~777	Output Relay
B	X	DDD	0~777	Input Relay
B	M	DDDD	0~4095	Auxiliary Relay
B	SM	DDD	0-511	Special Auxiliary Relay
B	S	DDDD	0~1535	Step Relay
B	T	DDD	0~511	Timer Relay
B	C	DDD	0~511	Counter Relay
B	D_Bit	DDDDDDdd	0~3276715	Data Register Bit
W	D	DDDD	0~32767	Data Register
W	SD	DDD	0~511	Special Data Register
W	Z	DDD	0~255	Indexed Addressing Register
W	TV	DDD	0~511	Timer
W	CV	DDD	0~199	Counter
DW	C_32Bit	DDD	200~511	Counter
W	U0	DDD	0~199	Special Module Register
W	U1	DDD	0~199	Special Module Register
W	U2	DDD	0~199	Special Module Register
W	U3	DDD	0~199	Special Module Register
W	U4	DDD	0~199	Special Module Register
W	U5	DDD	0~199	Special Module Register
W	U6	DDD	0~199	Special Module Register
W	U7	DDD	0~199	Special Module Register

Wiring Diagram:

The following is the view from the soldering point of a connector.



Diagram 1

cMT Series	<i>cMT3151</i>
eMT Series	<i>eMT3070 / eMT3105 / eMT3120 / eMT3150</i>
MT-iE	<i>MT8073iE / MT8102iE</i>
MT-XE	<i>MT8092XE</i>
MT-iP	<i>MT6103iP</i>

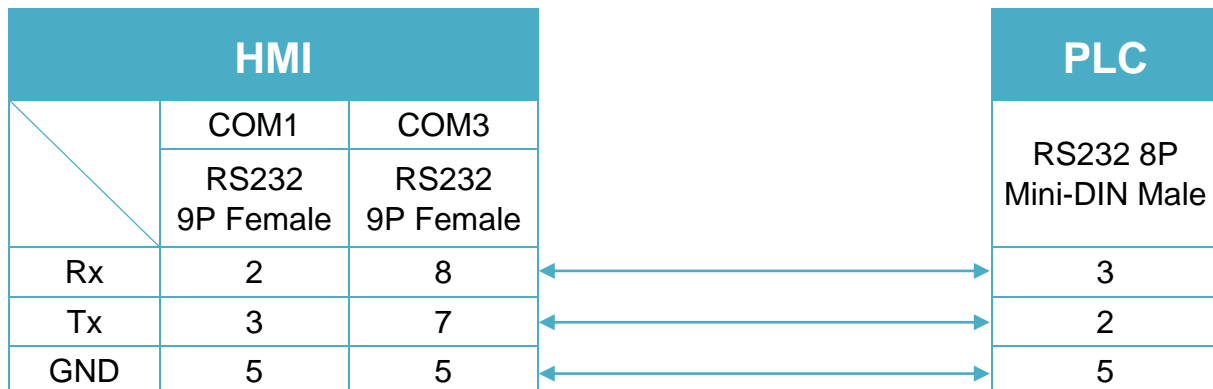


Diagram 2

cMT Series	<i>cMT-SVR</i>
mTV	<i>mTV</i>
MT-iE	<i>MT8070iE / MT6070iE / MT8100iE / MT8121iE / MT8150iE / MT8071iE / MT6071iE / MT8072iE / MT6072iE / MT8073iE / MT8101iE / MT8102iE / MT8103iE</i>
MT-XE	<i>MT8121XE / MT8150XE / MT8090XE /</i>

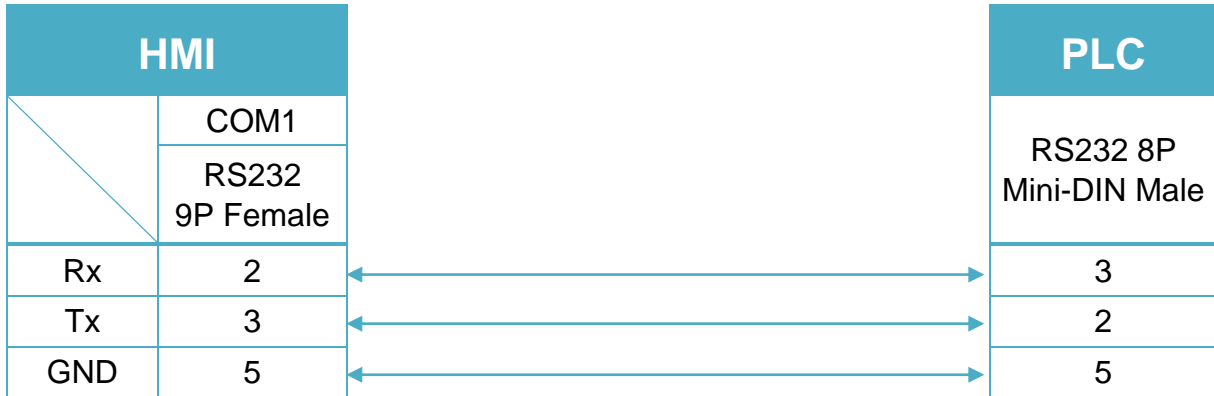


Diagram 3

MT-iE *MT8050iE*

MT-iP *MT6051iP / MT6071iP / MT8071iP*

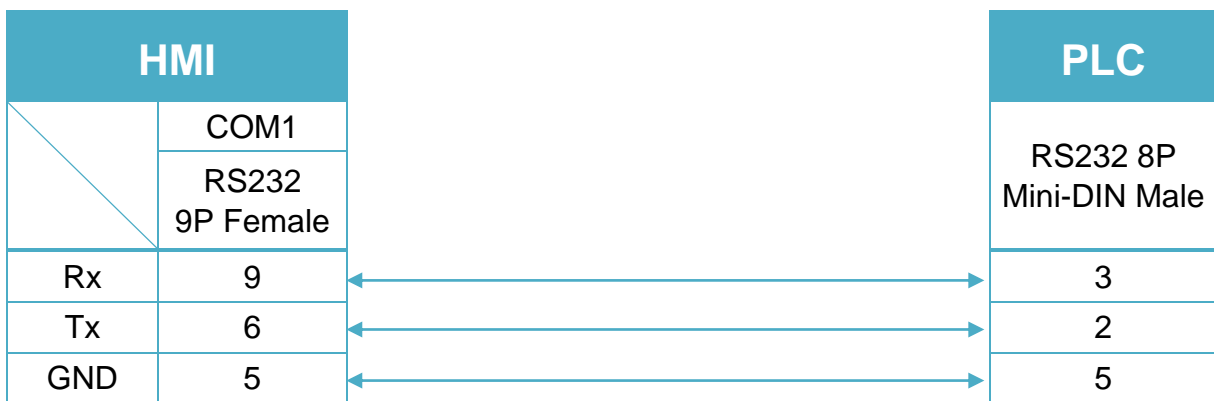


Diagram 4

Ethernet cable:



Mitsubishi A1S/A2N

Supported Series: Mitsubishi A1S/A2N

Website: <http://www.mitsubishi-automation.com/>

HMI Setting:

Parameters	Recommended	Options	Notes
PLC type	Mitsubishi A1S/A2N		
PLC I/F	RS232		
Baud rate	9600		
Data bits	8		
Parity	Odd		
Stop bits	1		
PLC sta. no.	0		

Device Address:

Bit/Word	Device	Format	Range	Memo
B	X	HHHH	0 ~ ffff	Input Relay
B	Y	HHHH	0 ~ ffff	Output Relay
B	M	DDDDD	0 ~ 65535	Auxiliary Relay
B	B	HHHH	0 ~ ffff	
B	F	DDDDD	0 ~ 65535	
W	TV	DDDDD	0 ~ 65535	Timer Memory
W	CV	DDDDD	0 ~ 65535	Counter Memory
W	D	DDDDD	0 ~ 65535	Data Register
W	W	HHHH	0 ~ ffff	
W	R	DDDDD	0 ~ 65535	

Wiring Diagram:

Use the RS422 to RS232 PLC programming cable (shown as follows)

MITSUBISHI AnS CPU

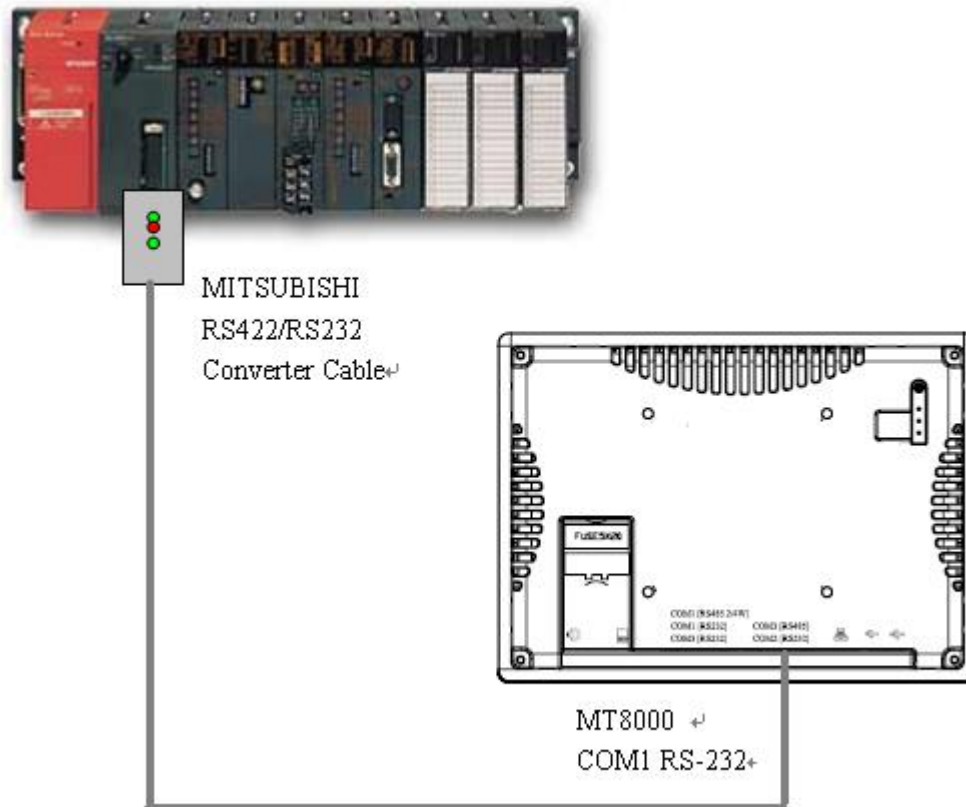


Diagram 1

cMT Series	cMT3151
eMT Series	eMT3070 / eMT3105 / eMT3120 / eMT3150
MT-iE	MT8070iE / MT6070iE / MT8100iE / MT8121iE / MT8150iE / MT8071iE / MT6071iE / MT8072iE / MT6072iE / MT8073iE / MT8101iE / MT8102iE / MT8103iE
MT-XE	MT8121XE / MT8150XE / MT8090XE / MT8092XE
MT-iP	MT6103iP

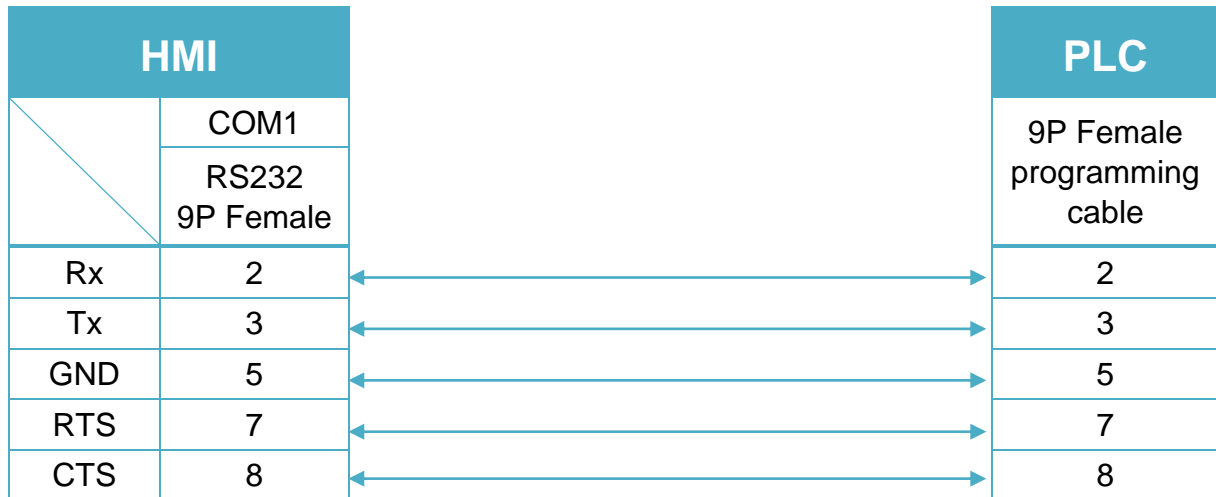
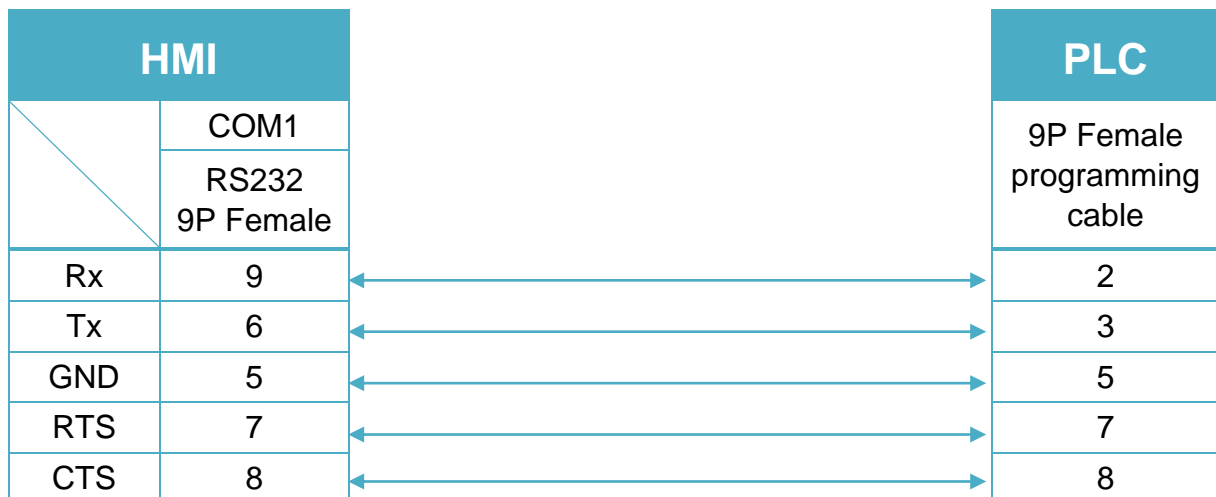


Diagram 2

MT-iP
MT6071iP / MT8071iP


Mitsubishi A2A/A2U/A2AS/A2USH

Supported Series: Mitsubishi A2A,A2U,A2AS,A2USH

Website: <http://www.mitsubishi-automation.com/>

HMI Setting:

Parameters	Recommended	Options	Notes
PLC type	Mitsubishi A2A/A2U/A2AS/A2USH		
PLC I/F	RS232		
Baud rate	9600		
Data bits	8		
Parity	Odd		
Stop bits	1		
PLC sta. no.	0		
Parameter 1	0	0 ~ 8	File register (0~8) K
Parameter 2	0	0 ~ 1	Set A2A and A2USH to 1

Device Address:

Bit/Word	Device type	Format	Range	Memo
B	X	HHHH	0 ~ 270f	Input Relay
B	Y	HHHH	0 ~ 270f	Output Relay
B	M	DDDD	0 ~ 9999	Auxiliary Relay
B	B	HHHH	0 ~ ffff	
B	F	DDDDD	0 ~ 65535	
W	TV	DDD	0 ~ 255	Timer Memory
W	CV	DDD	0 ~ 255	Counter Memory
W	D	DDDD	0 ~ 9999	Data Register
W	W	HHHH	0 ~ ffff	
W	R	DDDDD	0 ~ 65535	

Wiring Diagram:

Use the RS422 to RS232 PLC programming cable (shown as follows)

MITSUBISHI AnS CPU

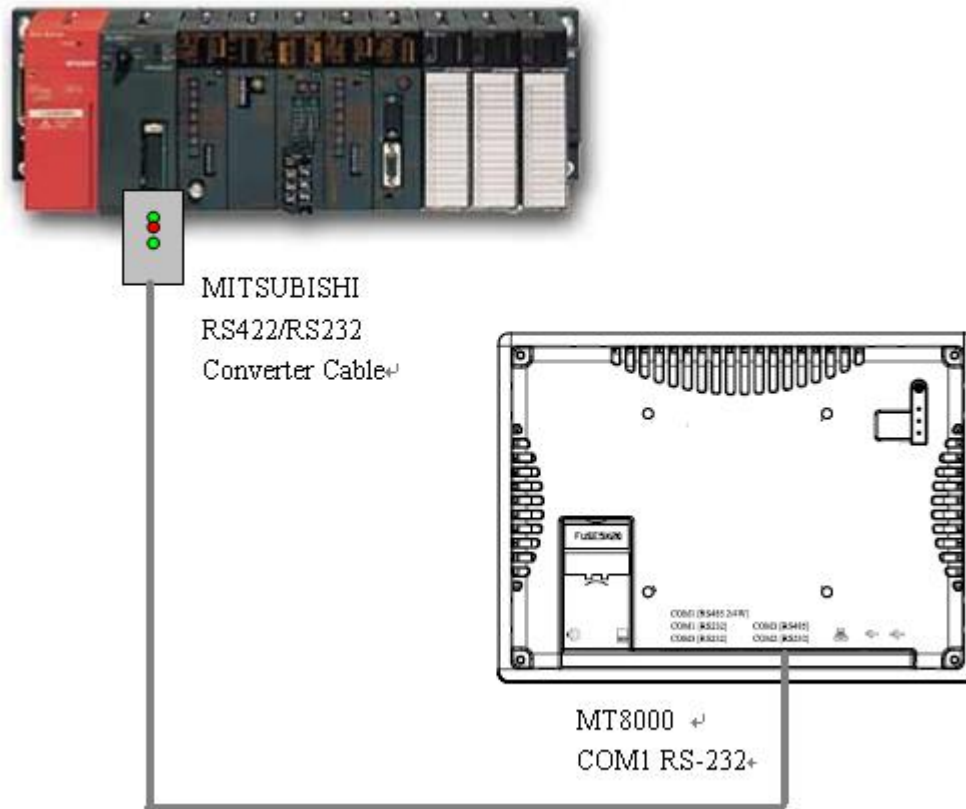
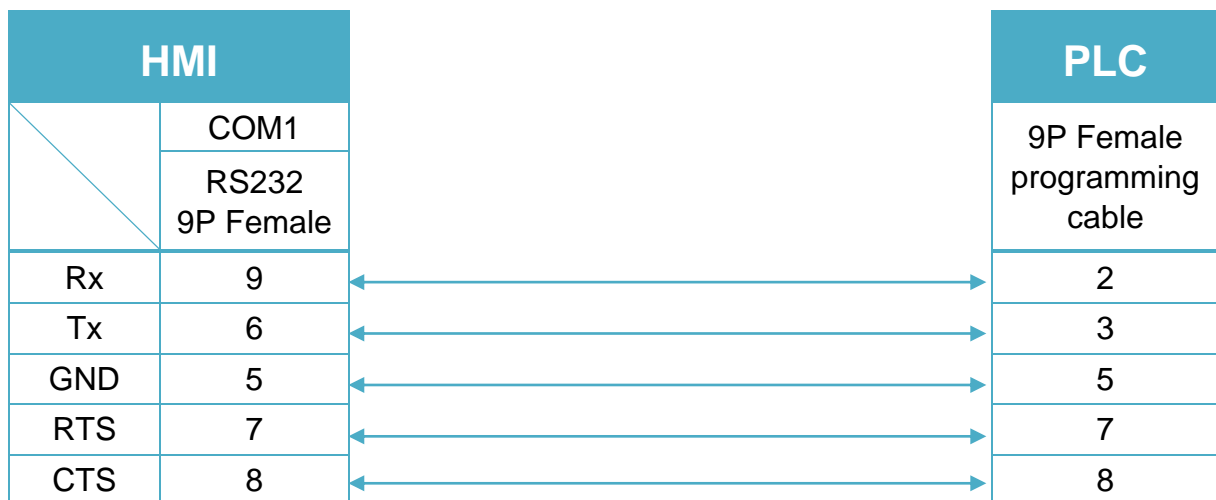


Diagram 1

cMT Series	cMT3151
eMT Series	eMT3070 / eMT3105 / eMT3120 / eMT3150
MT-iE	MT8070iE / MT6070iE / MT8100iE / MT8121iE / MT8150iE / MT8071iE / MT6071iE / MT8072iE / MT6072iE / MT8073iE / MT8101iE / MT8102iE / MT8103iE
MT-XE	MT8121XE / MT8150XE / MT8090XE / MT8092XE
MT-iP	MT6103iP



Diagram 2

MT-iP
MT6071iP / MT8071iP


Mitsubishi A2US

Supported Series: Mitsubishi A2US

Website: <http://www.mitsubishi-automation.com/>

HMI Setting:

Parameters	Recommended	Options	Notes
PLC type	Mitsubishi A2US		
PLC I/F	RS232		
Baud rate	9600		
Data bits	8		
Parity	Odd		
Stop bits	1		
PLC sta. no.	0		

Device Address:

Bit/Word	Device type	Format	Range	Memo
B	X	HHHH	0 ~ 270f	Input Relay
B	Y	HHHH	0 ~ 270f	Output Relay
B	M	DDDD	0 ~ 9999	Auxiliary Relay
W	TV	DDD	0 ~ 255	Timer Memory
W	CV	DDD	0 ~ 255	Counter Memory
W	D	DDDD	0 ~ 9999	Data Register

Wiring Diagram:

Use the RS422 to RS232 PLC programming cable (shown as follows)

MITSUBISHI AnS CPU

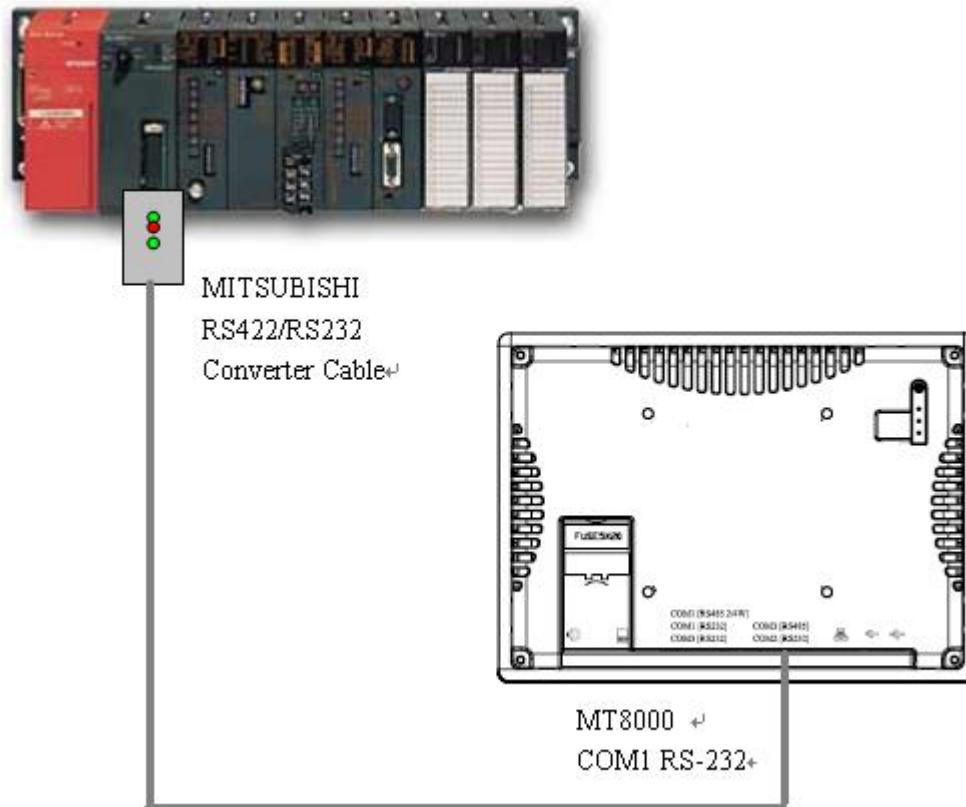


Diagram 1

cMT Series	<i>cMT3151</i>
eMT Series	<i>eMT3070 / eMT3105 / eMT3120 / eMT3150</i>
MT-iE	<i>MT8070iE / MT6070iE / MT8100iE / MT8121iE / MT8150iE / MT8071iE / MT6071iE / MT8072iE / MT6072iE / MT8073iE / MT8101iE / MT8102iE / MT8103iE</i>
MT-XE	<i>MT8121XE / MT8150XE / MT8090XE / MT8092XE</i>
MT-iP	<i>MT6103iP</i>

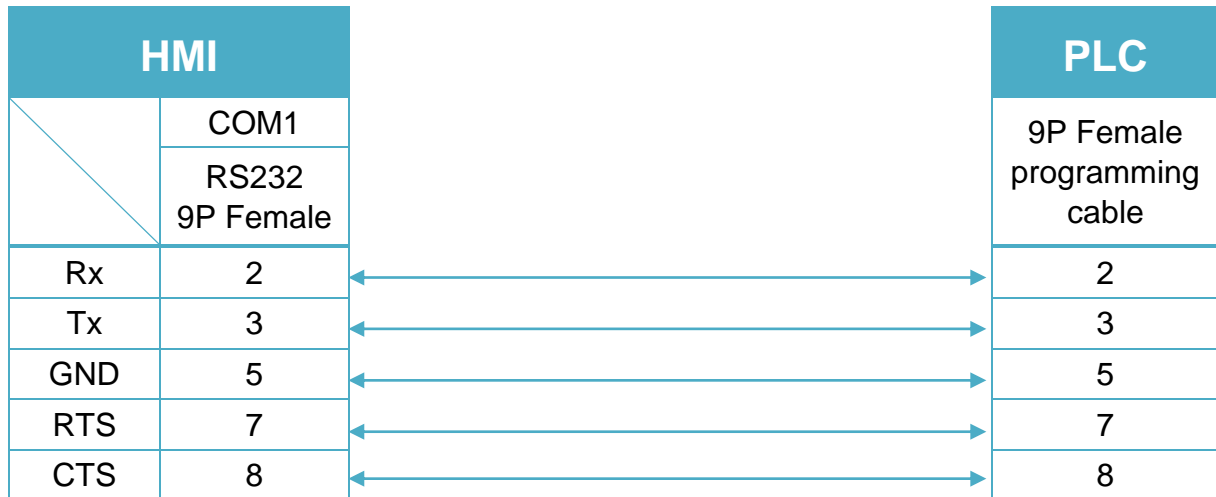
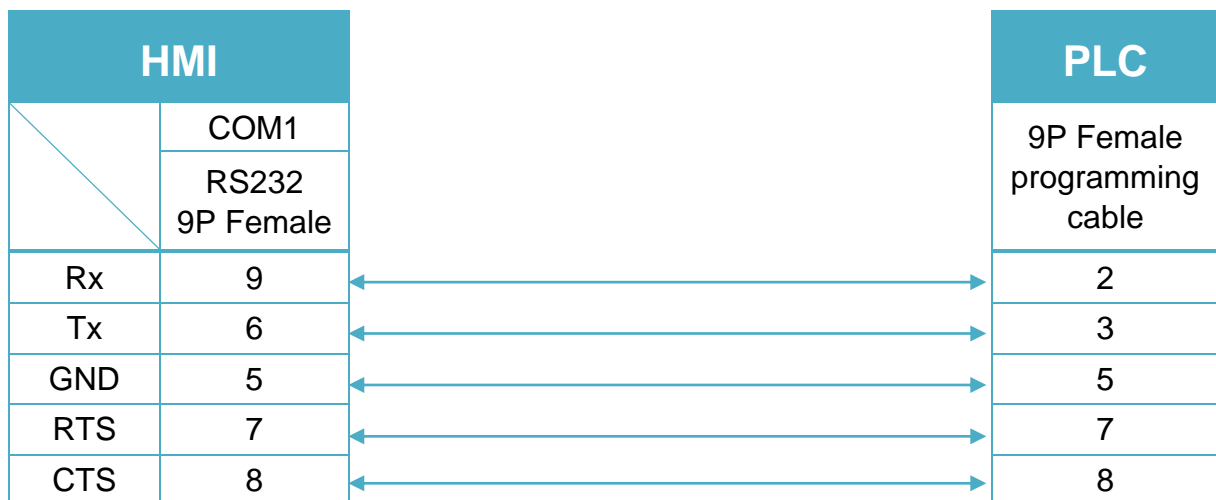


Diagram 2

MT-iP
MT6071iP / MT8071iP


Mitsubishi A3A/A3N/A1SH/A2SH

Supported Series: Mitsubishi A3A,A3N,A1SH,A2SH

Website: <http://www.mitsubishi-automation.com/>

HMI Setting:

Parameters	Recommended	Options	Notes
PLC type	Mitsubishi A3A/A3N/A1SH/A2SH		
PLC I/F	RS232		
Baud rate	9600		
Data bits	8		
Parity	Odd		
Stop bits	1		
PLC sta. no.	0		

Note: This driver is not available for On-line Simulation.

Device Address:

Bit/Word	Device type	Format	Range	Memo
B	X	HHHH	0 ~ ffff	Input Relay
B	Y	HHHH	0 ~ ffff	Output Relay
B	M	DDDDD	0 ~ 65535	Auxiliary Relay
B	B	HHHH	0 ~ ffff	
B	F	DDDDD	0 ~ 65535	
W	TV	DDDDD	0 ~ 65535	Timer Memory
W	CV	DDDDD	0 ~ 65535	Counter Memory
W	D	DDDDD	0 ~ 65535	Data Register
W	W	HHHH	0 ~ ffff	
W	R	DDDDD	0 ~ 65535	

Wiring Diagram:

Use the RS422 to RS232 PLC programming cable (shown as follows)

MITSUBISHI AnS CPU

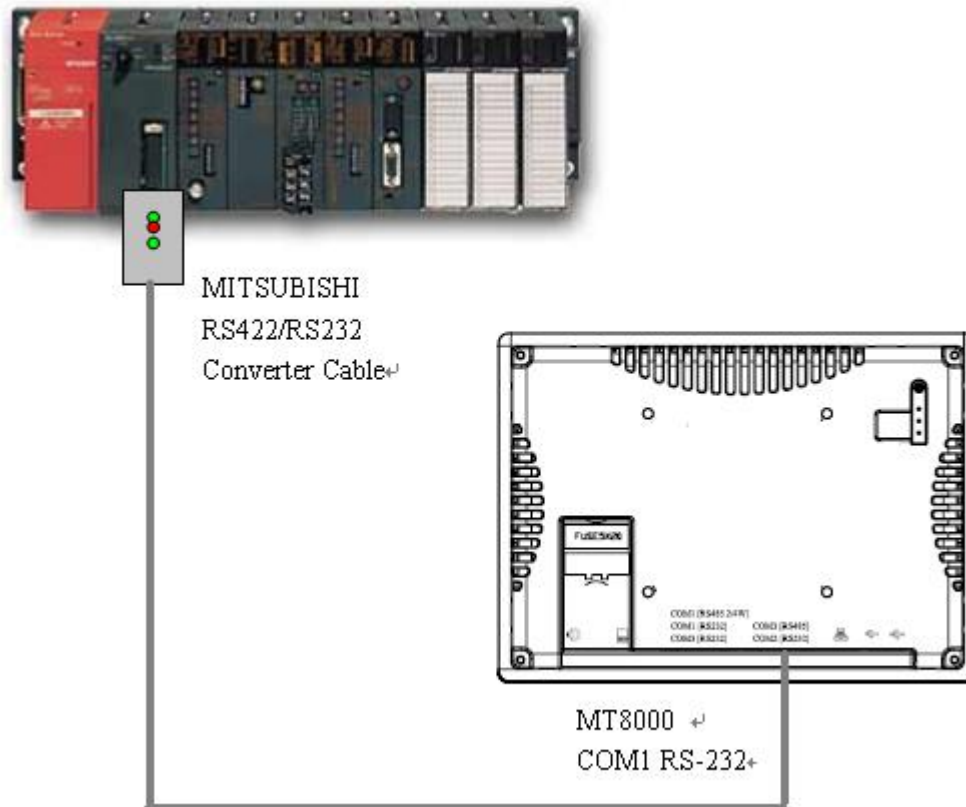
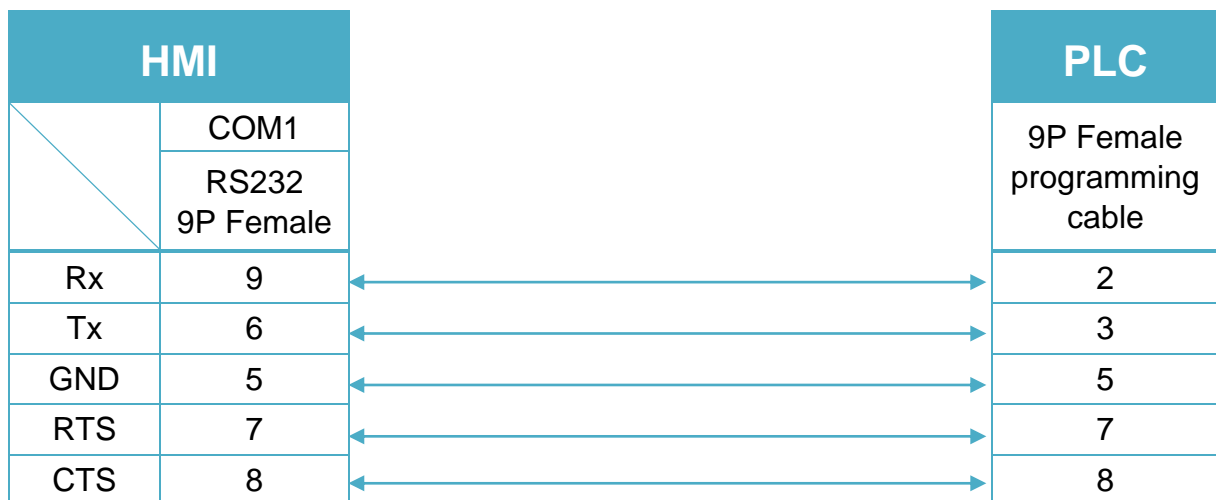


Diagram 1

cMT Series	<i>cMT3151</i>
eMT Series	<i>eMT3070 / eMT3105 / eMT3120 / eMT3150</i>
MT-iE	<i>MT8070iE / MT6070iE / MT8100iE / MT8121iE / MT8150iE / MT8071iE / MT6071iE / MT8072iE / MT6072iE / MT8073iE / MT8101iE / MT8102iE / MT8103iE</i>
MT-XE	<i>MT8121XE / MT8150XE / MT8090XE / MT8092XE</i>
MT-iP	<i>MT6103iP</i>



Diagram 2

MT-iP
MT6071iP / MT8071iP


Mitsubishi AJ71

Supported Series: Mitsubishi A series PLC with AJ71C24 communication module using the Computer Link protocol.

Website: <http://www.mitsubishi-automation.com>

HMI Setting:

Parameters	Recommended	Options	Notes
PLC type	Mitsubishi AJ71	Mitsubishi AJ71 (AnA/AnU CPU), Mitsubishi AJ71 (Format 4)	
PLC I/F	RS485 4W	RS485 4W, RS232	
Baud rate	19200	9600, 19200	
Data bits	8	8	
Parity	Even	Even, Odd, None	
Stop bits	1	1	
PLC sta. no.	0		

PLC Setting:

Communication mode	Computer Link protocol 9600, Even, 8, 1 (default)
Mode setting switch	Format 1
Parity check	Enable
Sum check	Enable

Device Address:

Bit/Word	Device type	Format	Range	Memo
B	X	HHHH	0 ~ ffff	Input Bits
B	Y	HHHH	0 ~ ffff	Output Bits
B	M	DDDDD	0 ~ 65535	Internal Relays
B	L	DDDDD	0 ~ 65535	
B	T	DDDDD	0 ~ 65535	
B	C	DDDDD	0 ~ 65535	
B	B	HHHH	0 ~ ffff	
B	F	DDDDD	0 ~ 65535	
W	TV	DDDDD	0 ~ 65535	Timer Preset Value

Bit/Word	Device type	Format	Range	Memo
W	CV	DDDDD	0 ~ 65535	Counter Preset Value
W	D	DDDDD	0 ~ 65535	Data Registers
W	W	HHHH	0 ~ ffff	
W	R	DDDDD	0 ~ 65535	

Wiring Diagram:

AJ71C24 RS422 Terminal (Diagram 1 ~ Diagram 4)

Diagram 1

cMT Series	<i>cMT3151</i>
eMT Series	<i>eMT3070 / eMT3105 / eMT3120 / eMT3150</i>
MT-iE	<i>MT8070iE / MT6070iE / MT8100iE / MT8121iE / MT8150iE</i>
MT-XE	<i>MT8121XE / MT8150XE</i>

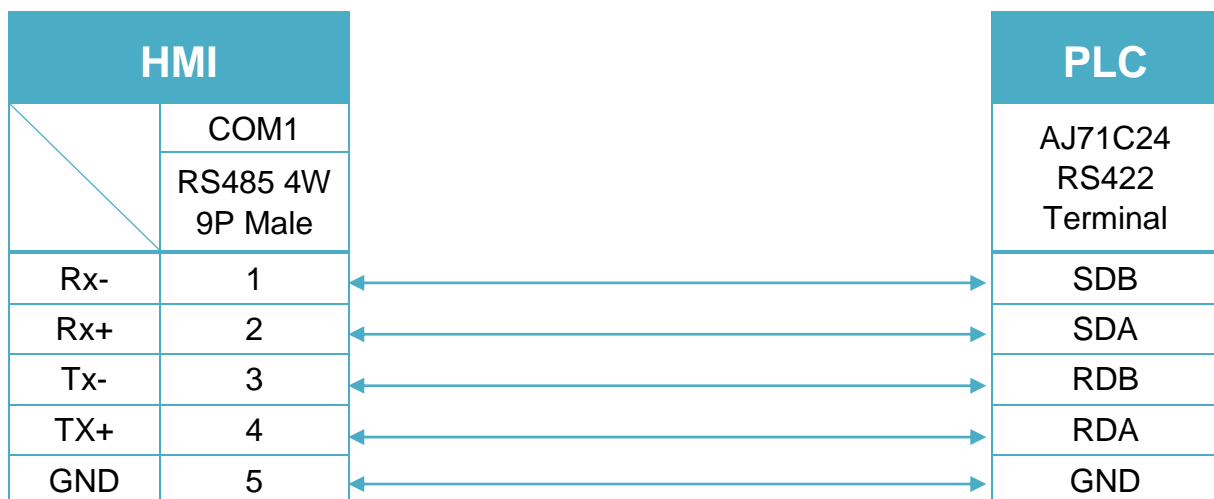


Diagram 2

cMT Series *cMT-SVR*

mTV *mTV*

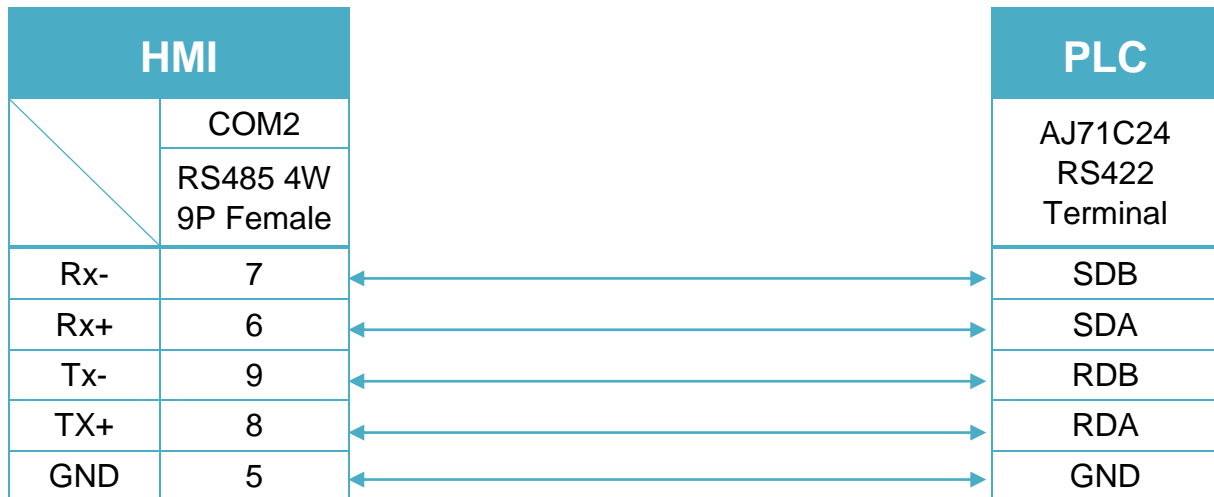


Diagram 3

MT-iE *MT8071iE / MT6071iE / MT8072iE / MT6072iE / MT8073iE /
MT8101iE / MT8102iE / MT8103iE*

MT-XE *MT8090XE / MT8092XE*

MT-iP *MT6071iP / MT8071iP / MT6103iP*

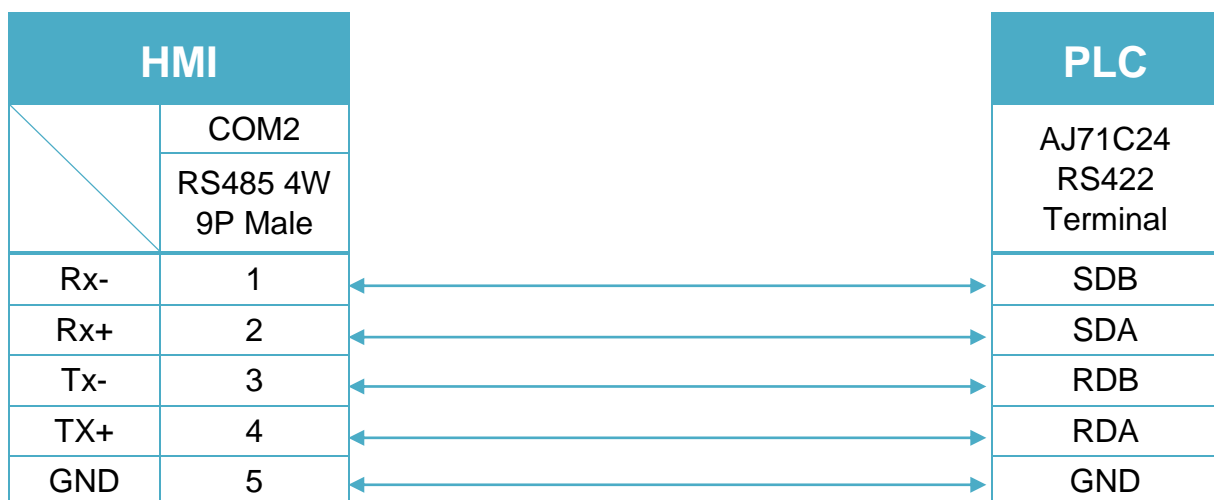
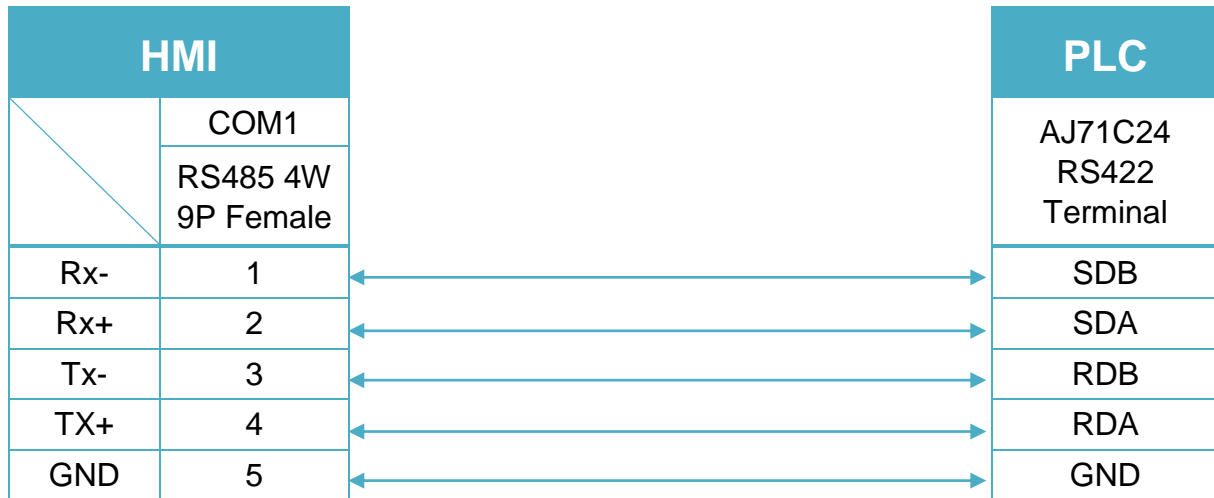


Diagram 4
MT-iE *MT8050iE*
MT-iP *MT6051iP*


A1SJ71UC24-R2 (Diagram 5 ~ Diagram 7)

Diagram 5

cMT Series	<i>cMT3151</i>
eMT Series	<i>eMT3070 / eMT3105 / eMT3120 / eMT3150</i>
MT-iE	<i>MT8073iE / MT8102iE</i>
MT-XE	<i>MT8092XE</i>
MT-iP	<i>MT6103iP</i>

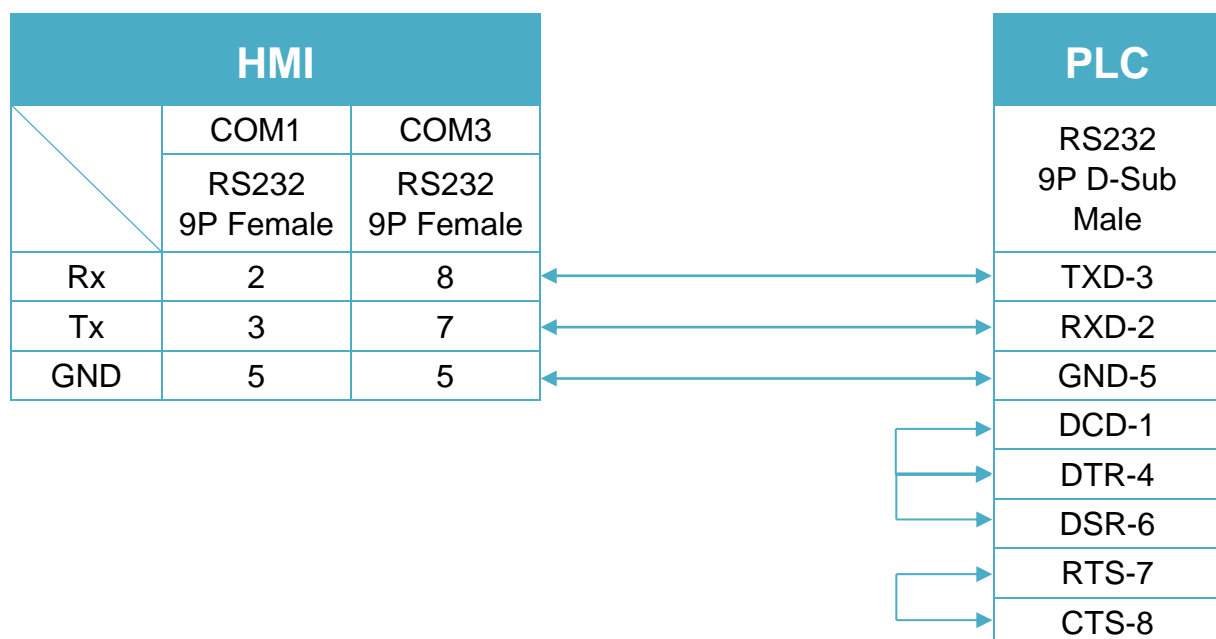


Diagram 6

cMT Series	cMT-SVR
mTV	mTV
MT-iE	MT8070iE / MT6070iE / MT8100iE / MT8121iE / MT8150iE / MT8071iE / MT6071iE / MT8072iE / MT6072iE / MT8073iE / MT8101iE / MT8102iE / MT8103iE
MT-XE	MT8121XE / MT8150XE / MT8090XE /

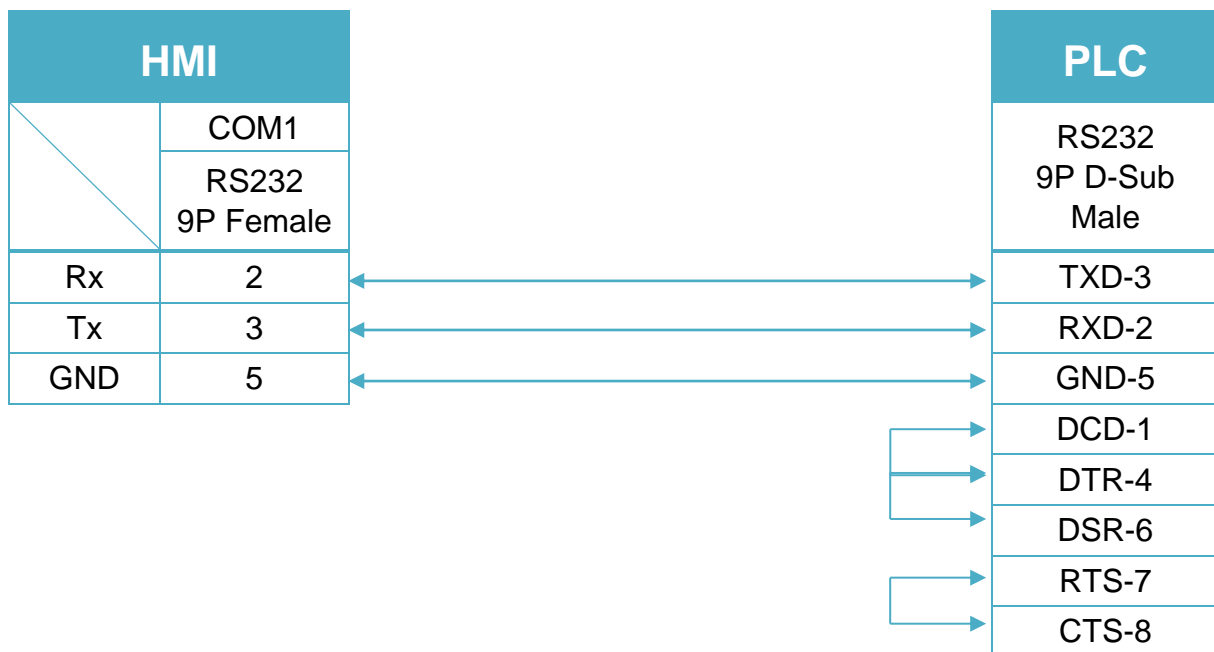
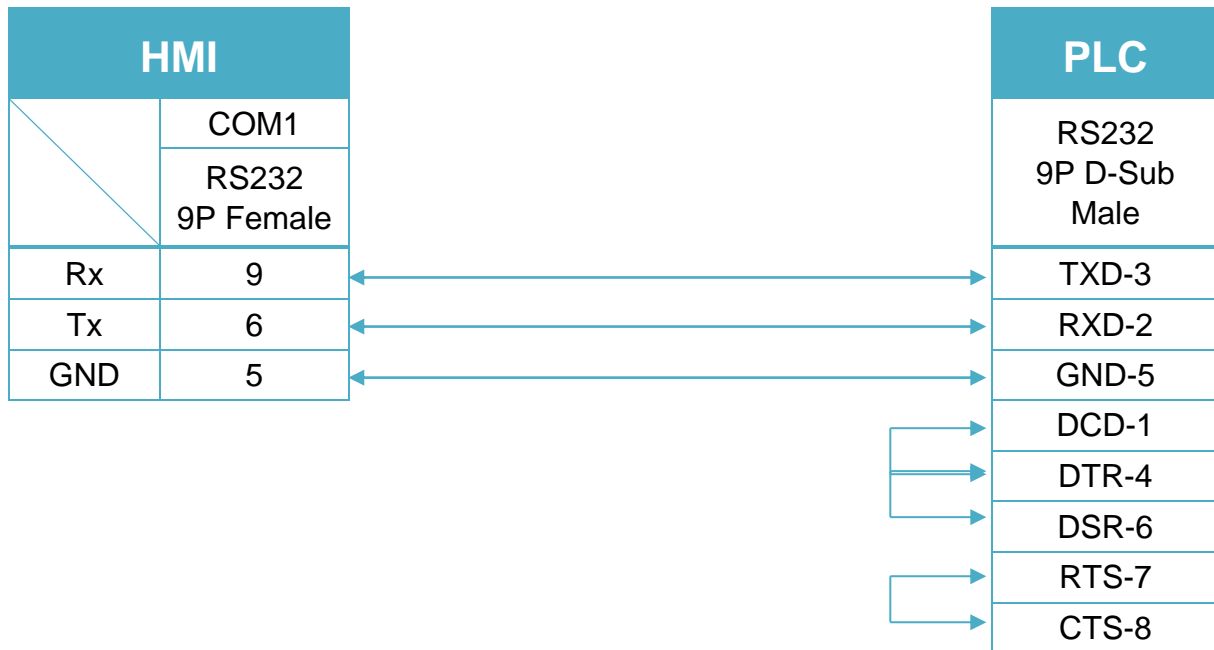


Diagram 7

MT-iE
MT8050iE
MT-iP
MT6051iP / MT6071iP / MT8071iP


Mitsubishi AJ71 (AnA/AnU CPU)

Supported Series: Mitsubishi AJ71 (AnA/AnU CPU)

Website: <http://www.mitsubishi-automation.com>

HMI Setting:

Parameters	Recommended	Options	Notes
PLC type	Mitsubishi AJ71 (AnA/AnU CPU)		
PLC I/F	RS485 4W	RS485 4W, RS232	
Baud rate	19200	9600, 19200	
Data bits	8	8	
Parity	Even	Even, Odd, None	
Stop bits	1	1	
PLC sta. no.	0		

PLC Setting:

Communication mode	Computer Link protocol 9600, Even, 8, 1 (default)
Mode setting switch	Format 1
Parity check	Enable
Sum check	Enable

Device Address:

Bit/Word	Device type	Format	Range	Memo
B	X	HHHH	0 ~ ffff	Input Bits
B	Y	HHHH	0 ~ ffff	Output Bits
B	M	DDDDD	0 ~ 65535	Internal Relays
B	T	DDDDD	0 ~ 65535	
B	C	DDDDD	0 ~ 65535	
B	B	HHHH	0 ~ ffff	
B	F	DDDDD	0 ~ 65535	
B	L	DDDDD	0 ~ 65535	
W	TV	DDDDD	0 ~ 65535	Timer Preset Value
W	CV	DDDDD	0 ~ 65535	Counter Preset Value
W	D	DDDDD	0 ~ 65535	Data Registers
W	W	HHHH	0 ~ ffff	

Bit/Word	Device type	Format	Range	Memo
W	R	DDDDD	0 ~ 65535	

Wiring Diagram:

RS422 Terminal (Diagram 1 ~ Diagram 4)

Diagram 1

cMT Series	<i>cMT3151</i>
eMT Series	<i>eMT3070 / eMT3105 / eMT3120 / eMT3150</i>
MT-iE	<i>MT8070iE / MT6070iE / MT8100iE / MT8121iE / MT8150iE</i>
MT-XE	<i>MT8121XE / MT8150XE</i>

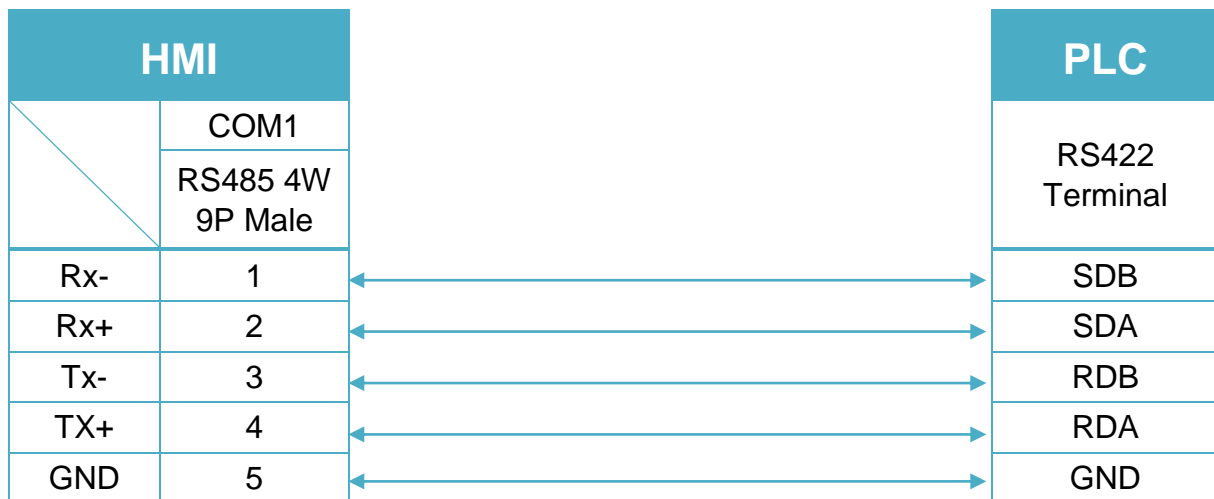


Diagram 2

cMT Series *cMT-SVR*

mTV *mTV*

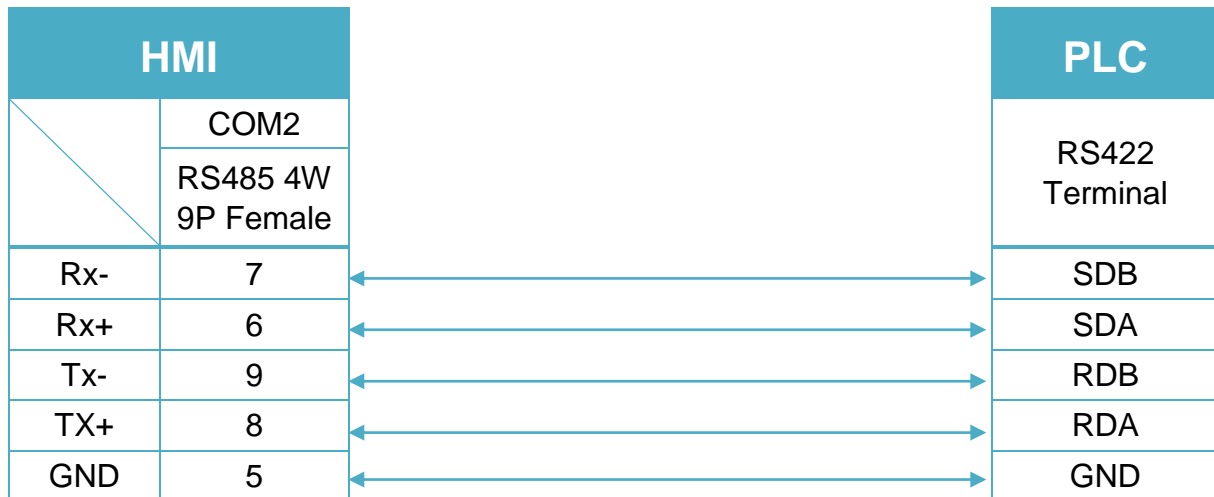


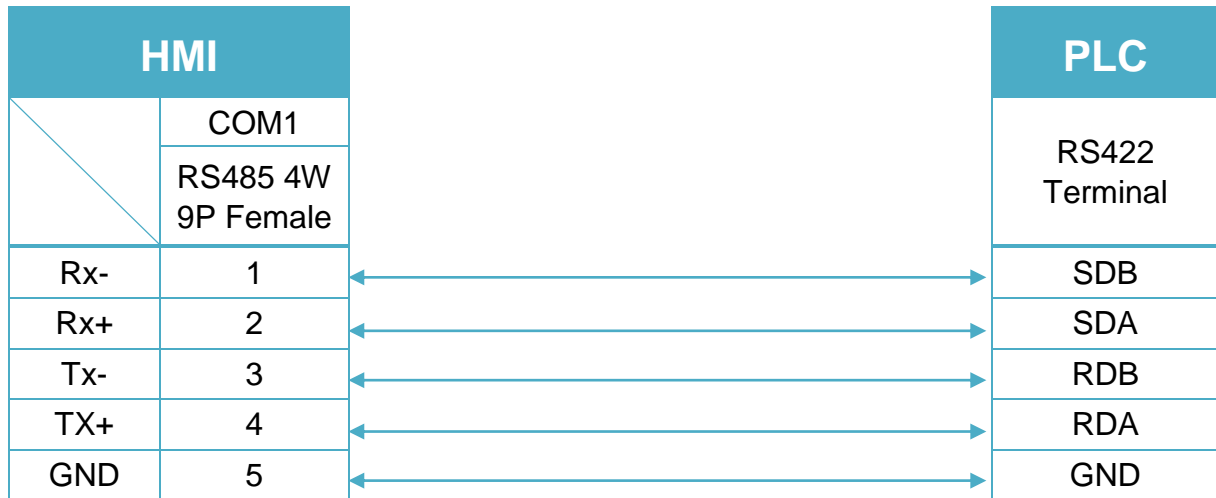
Diagram 3

MT-iE *MT8071iE / MT6071iE / MT8072iE / MT6072iE / MT8073iE /
MT8101iE / MT8102iE / MT8103iE*

MT-XE *MT8090XE / MT8092XE*

MT-iP *MT6071iP / MT8071iP / MT6103iP*



Diagram 4
MT-iE *MT8050iE*
MT-iP *MT6051iP*


RS232 (Diagram 5 ~ Diagram 8)

Diagram 5

cMT Series	<i>cMT3151</i>
eMT Series	<i>eMT3070 / eMT3105 / eMT3120 / eMT3150</i>
MT-iE	<i>MT8073iE / MT8102iE</i>
MT-XE	<i>MT8092XE</i>
MT-iP	<i>MT6103iP</i>

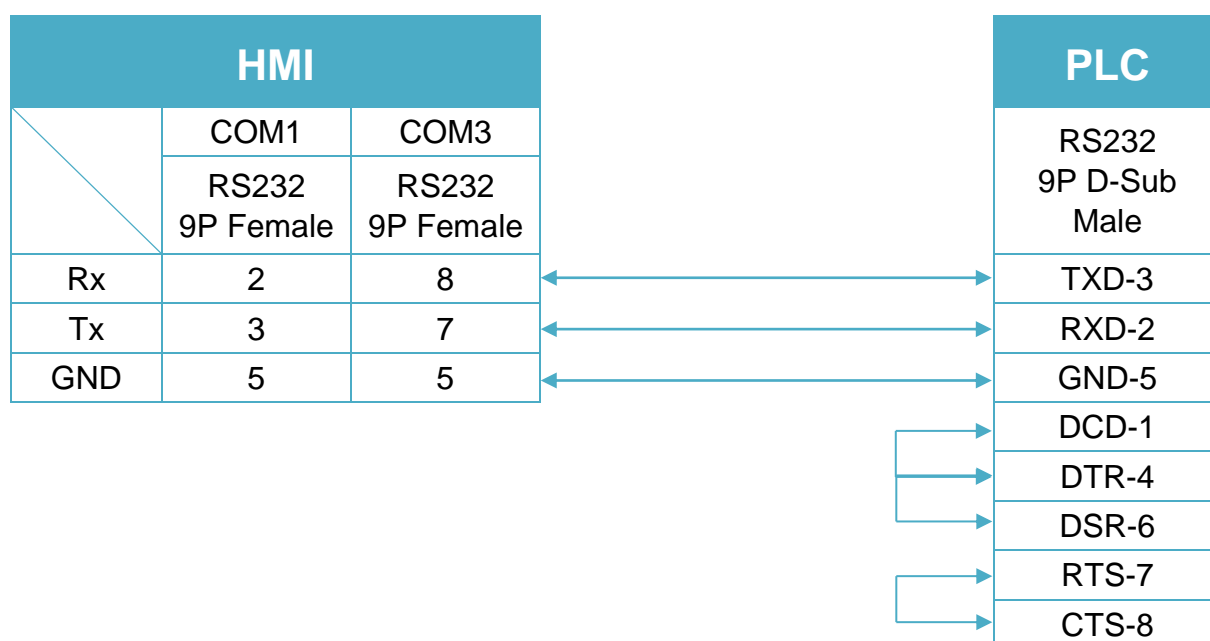


Diagram 6

cMT Series	cMT-SVR
mTV	mTV
MT-iE	MT8070iE / MT6070iE / MT8100iE / MT8121iE / MT8150iE / MT8071iE / MT6071iE / MT8072iE / MT6072iE / MT8073iE / MT8101iE / MT8102iE / MT8103iE
MT-XE	MT8121XE / MT8150XE / MT8090XE /

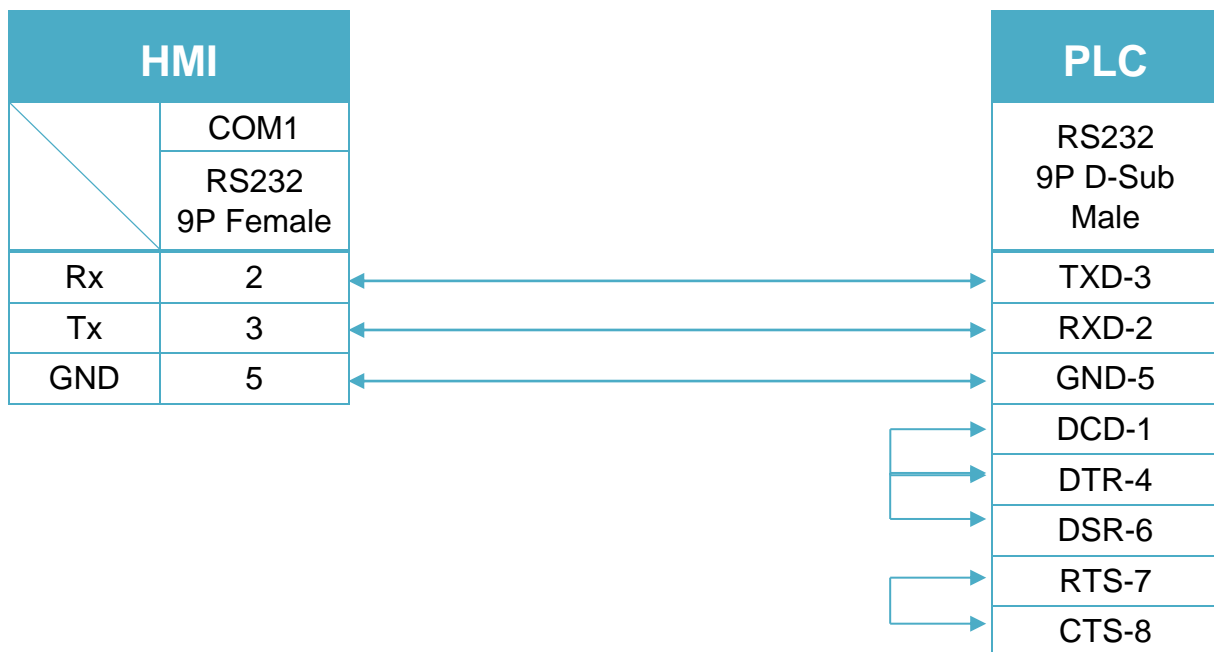
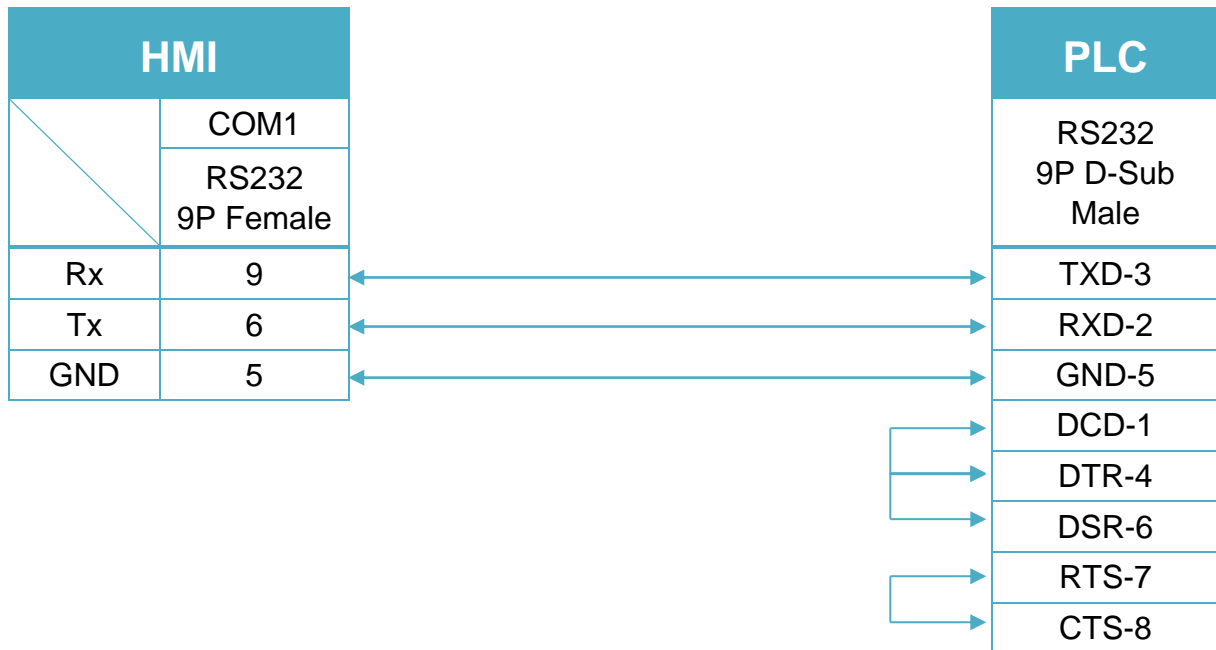


Diagram 7
MT-iE
MT8050iE
MT-iP
MT6051iP / MT6071iP / MT8071iP


Mitsubishi AJ71 (Format 4)

Supported Series: Mitsubishi A series PLC with AJ71C24 communication module using the Computer Link protocol.

Website: <http://www.mitsubishi-automation.com>

HMI Setting:

Parameters	Recommended	Options	Notes
PLC type	Mitsubishi AJ71 (Format 4)		
PLC I/F	RS485 4W	RS485 4W, RS232	
Baud rate	19200	9600, 19200	
Data bits	8	8	
Parity	Even	Even, Odd, None	
Stop bits	1	1	
PLC sta. no.	0		

PLC Setting:

Communication mode	Computer Link protocol 9600, Even, 8, 1 (default)
Mode setting switch	Format 4
Parity check	Enable
Sum check	Enable

Device Address:

Bit/Word	Device type	Format	Range	Memo
B	X	HHHH	0 ~ ffff	Input Bits
B	Y	HHHH	0 ~ ffff	Output Bits
B	M	DDDDD	0 ~ 65535	Internal Relays
B	T	DDDDD	0 ~ 65535	
B	C	DDDDD	0 ~ 65535	
B	B	HHHH	0 ~ ffff	
B	F	DDDDD	0 ~ 65535	
W	TV	DDDDD	0 ~ 65535	Timer Preset Value
W	CV	DDDDD	0 ~ 65535	Counter Preset Value
W	D	DDDDD	0 ~ 65535	Data Registers
W	W	HHHH	0 ~ ffff	

Bit/Word	Device type	Format	Range	Memo
W	R	DDDDD	0 ~ 65535	

Wiring Diagram:

AJ71C24 RS422 Terminal (Diagram 1 ~ Diagram 4)

Diagram 1

cMT Series	<i>cMT3151</i>
eMT Series	<i>eMT3070 / eMT3105 / eMT3120 / eMT3150</i>
MT-iE	<i>MT8070iE / MT6070iE / MT8100iE / MT8121iE / MT8150iE</i>
MT-XE	<i>MT8121XE / MT8150XE</i>

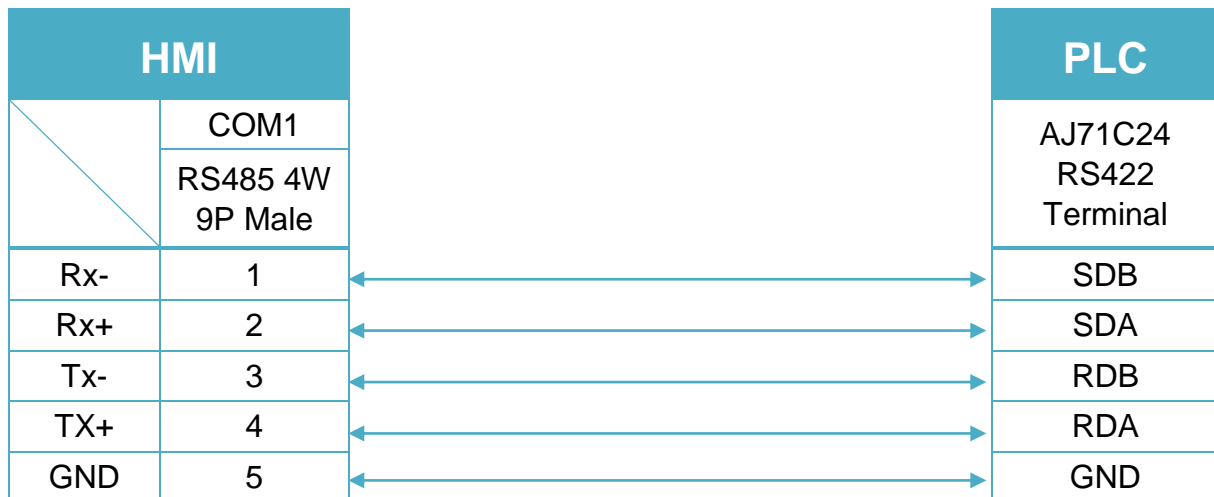


Diagram 2

cMT Series *cMT-SVR*

mTV *mTV*

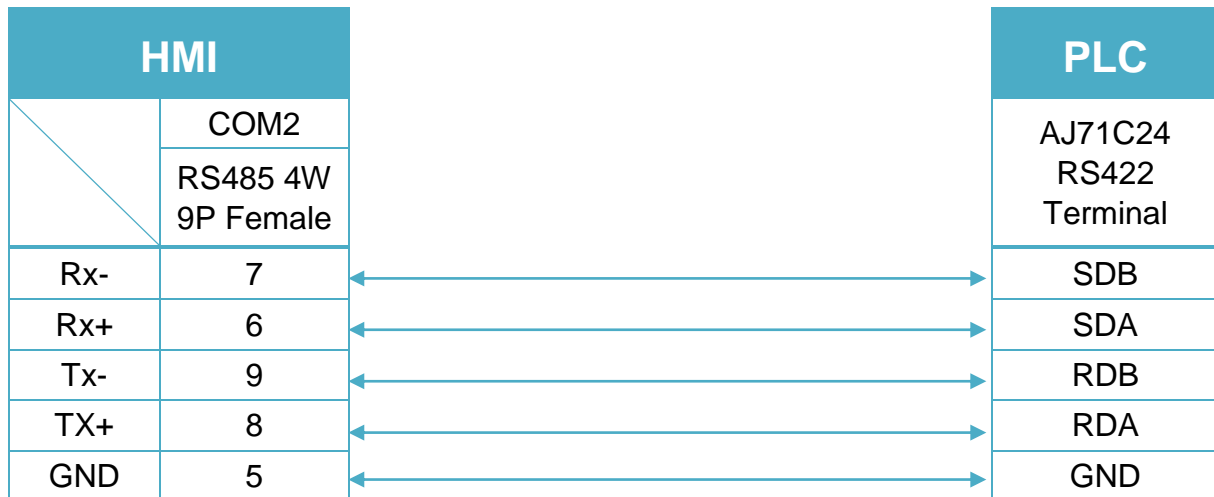


Diagram 3

MT-iE *MT8071iE / MT6071iE / MT8072iE / MT6072iE / MT8073iE /
MT8101iE / MT8102iE / MT8103iE*

MT-XE *MT8090XE / MT8092XE*

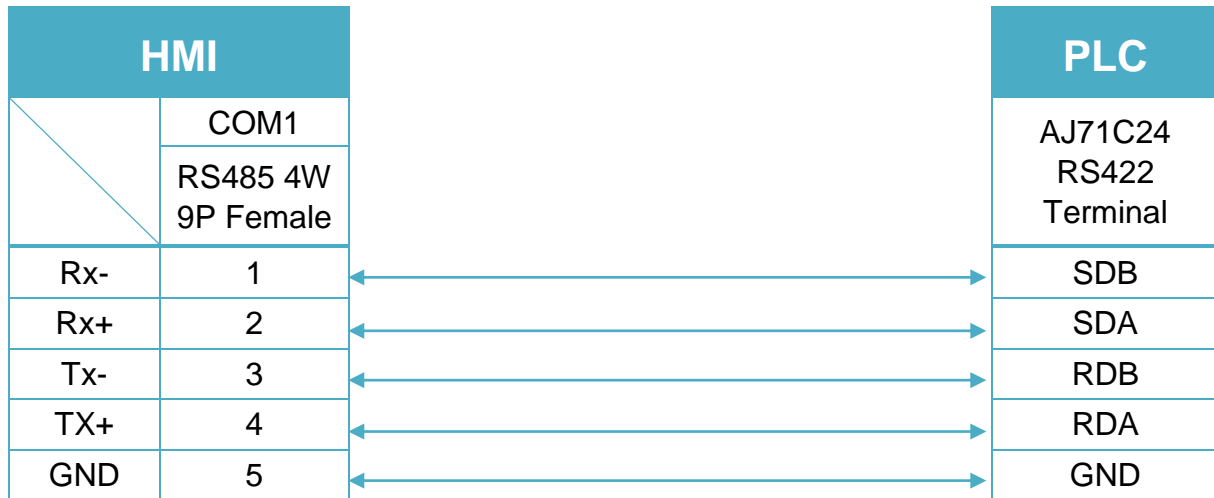
MT-iP *MT6071iP / MT8071iP / MT6103iP*



Diagram 4

MT-iE *MT8050iE*

MT-iP *MT6051iP*



RS232 (Diagram 5 ~ Diagram 8)

Diagram 5

cMT Series	<i>cMT3151</i>
eMT Series	<i>eMT3070 / eMT3105 / eMT3120 / eMT3150</i>
MT-iE	<i>MT8073iE / MT8102iE</i>
MT-XE	<i>MT8092XE</i>
MT-iP	<i>MT6103iP</i>

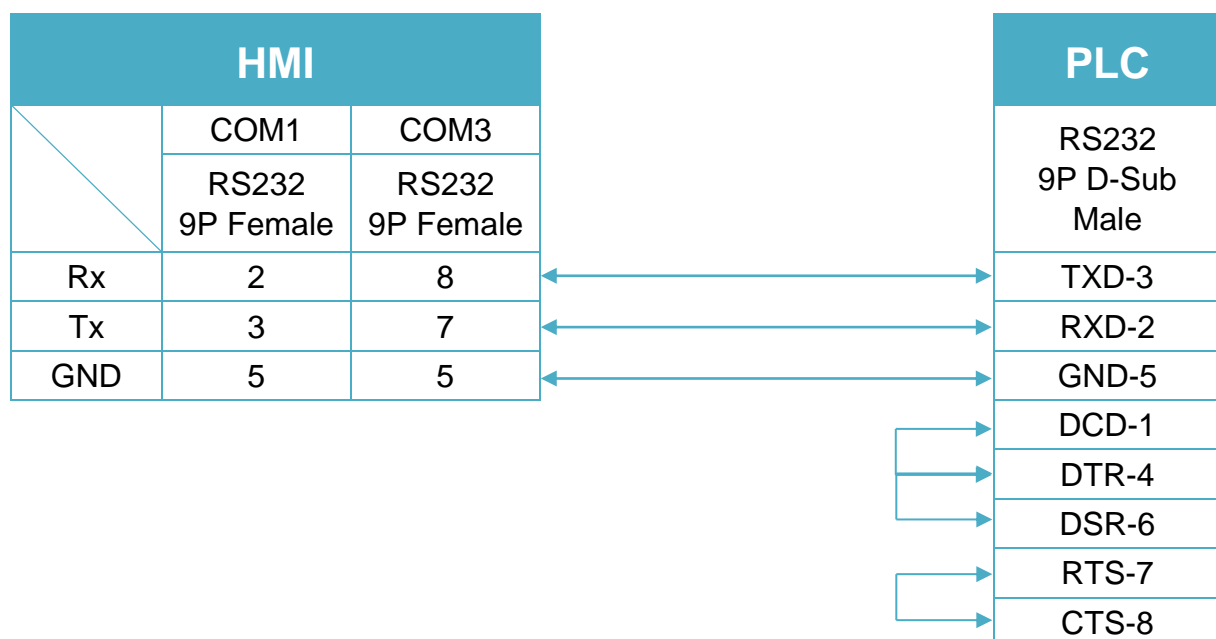


Diagram 6

cMT Series	cMT-SVR
mTV	mTV
MT-iE	MT8070iE / MT6070iE / MT8100iE / MT8121iE / MT8150iE / MT8071iE / MT6071iE / MT8072iE / MT6072iE / MT8073iE / MT8101iE / MT8102iE / MT8103iE
MT-XE	MT8121XE / MT8150XE / MT8090XE /

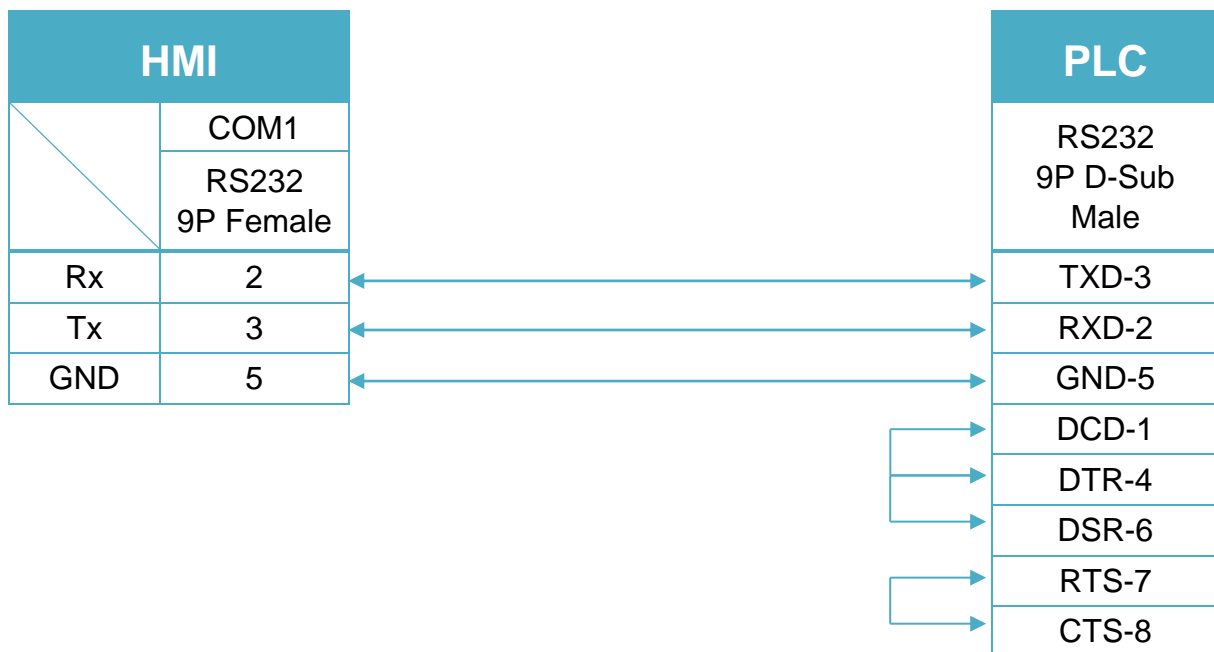
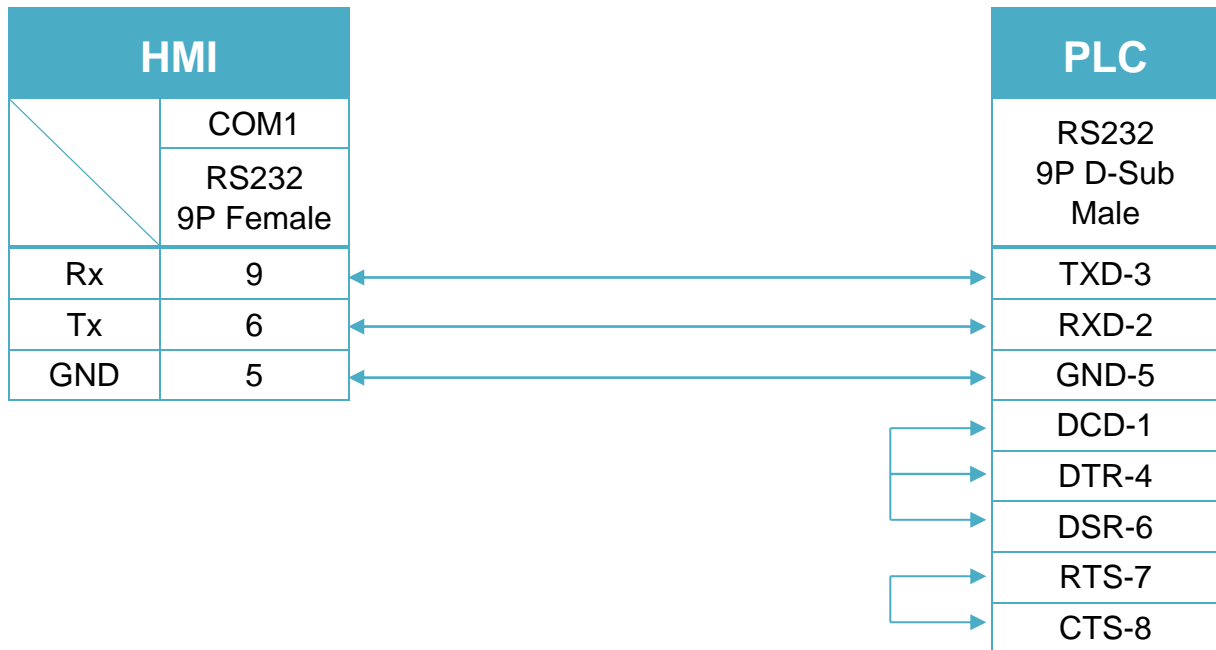


Diagram 7
MT-iE
MT8050iE
MT-iP
MT6051iP / MT6071iP / MT8071iP


Mitsubishi Alpha2

Supported Series: Mitsubishi Alpha2 Series

Website: <http://www.mitsubishi-automation.com>

HMI Setting:

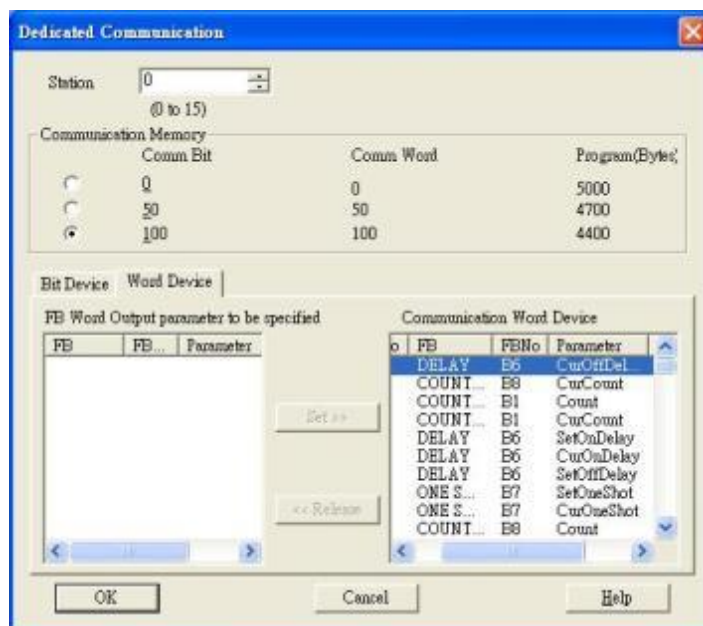
Parameters	Recommended	Options	Notes
PLC type	Mitsubishi Alpha2		
PLC I/F	RS232		
Baud rate	9600		
Data bits	8		
Parity	None		
Stop bits	1		
PLC sta.	0		

Device Address:

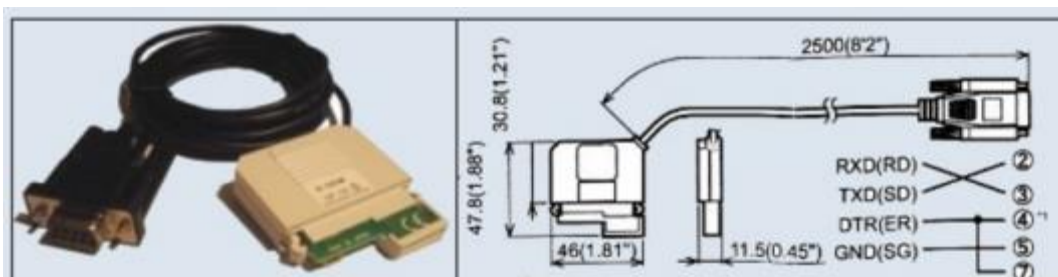
Bit/Word	Device type	Format	Range	Memo
B	M	DD	1 ~ 14	
B	I	DD	1 ~ 15	
B	EI	DDD	129 ~ 132	
B	O	D	1 ~ 9	
B	EO	DDD	129 ~ 132	
B	K	D	1 ~ 8	
B	E	D	1 ~ 4	
B	A	D	1 ~ 4	
B	N	D	1 ~ 4	
W	CB	DDD	1 ~ 100	*Note
W	AI	D	1 ~ 8	
W	CW	DDD	1 ~ 100	*Note

Note:

Delicated communication for CB and CW.


Wiring Diagram:

AL-232CAB RS-232C CABLE


Diagram 1
cMT Series
cMT3151
eMT Series
eMT3070 / eMT3105 / eMT3120 / eMT3150
MT-iE
***MT8070iE / MT6070iE / MT8100iE / MT8121iE / MT8150iE /
MT8071iE / MT6071iE / MT8072iE / MT6072iE / MT8073iE /
MT8101iE / MT8102iE / MT8103iE***
MT-XE
MT8121XE / MT8150XE / MT8090XE / MT8092XE
MT-iP
MT6103iP

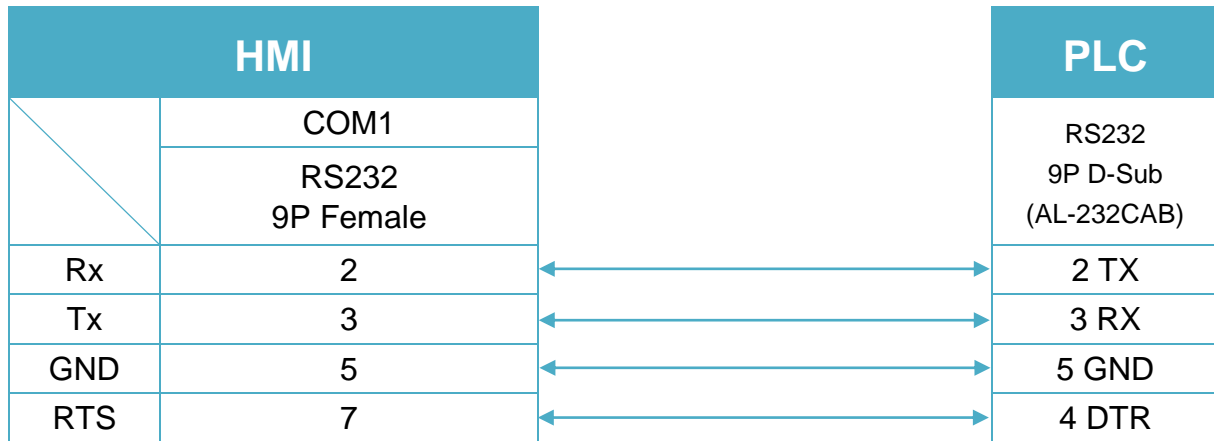
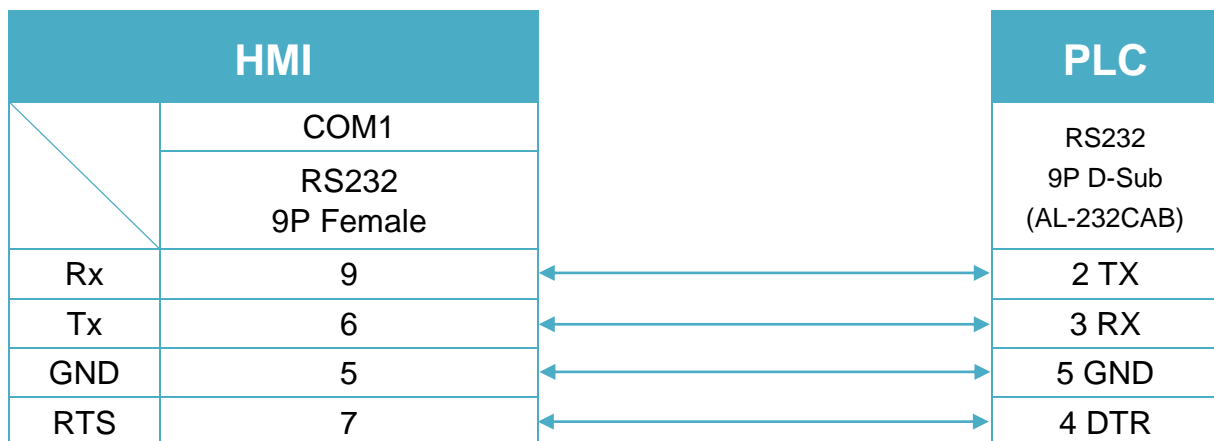


Diagram 2

MT-iP
MT6071iP / MT8071iP


Mitsubishi F930GOT Server

Supported Series: F930GOT general-purpose communication Type 1.

HMI Setting:

Parameters	Recommended	Options	Notes
PLC type	F930GOT Server		
PLC I/F	RS232		
Baud rate	38400	9600, 115200	
Data bits	8	7 or 8	
Parity	None	Even, Odd, None	
Stop bits	1	1 or 2	
PLC sta. no.	1		

Device Address:

Bit/Word	Device type	Format	Range	Memo
B	RB	DDDD	0 ~ 2047	
W	RW	DDDDD	0 ~ 65535	

Note: In PLC name drop - down menu don't select F930GOT Server.

Please select Local HMI, Device Type=RW.

Wiring Diagram:

Diagram 1

cMT Series	<i>cMT3151</i>
eMT Series	<i>eMT3070 / eMT3105 / eMT3120 / eMT3150</i>
MT-iE	<i>MT8073iE / MT8102iE</i>
MT-XE	<i>MT8092XE</i>
MT-iP	<i>MT6103iP</i>

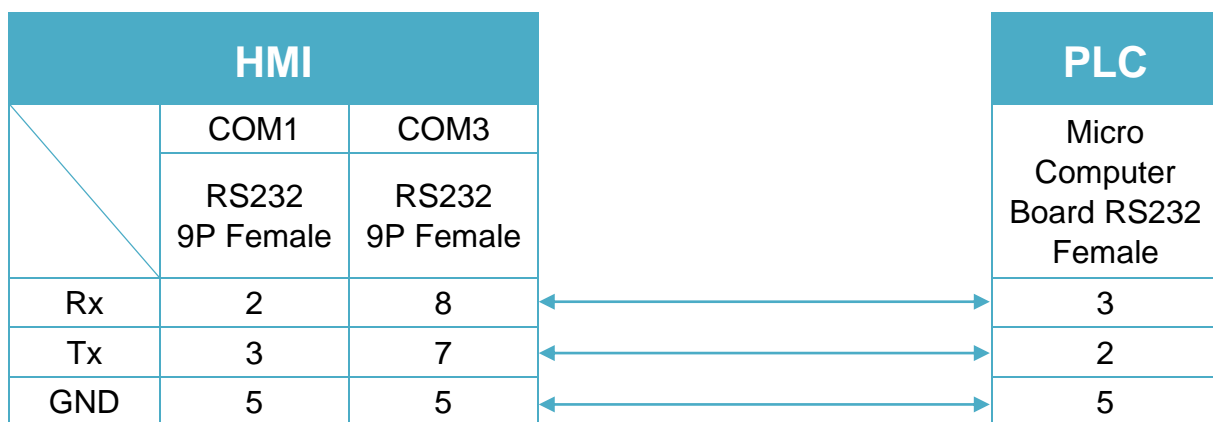


Diagram 2

cMT Series	cMT-SVR
mTV	mTV
MT-iE	MT8070iE / MT6070iE / MT8100iE / MT8121iE / MT8150iE / MT8071iE / MT6071iE / MT8072iE / MT6072iE / MT8073iE / MT8101iE / MT8102iE / MT8103iE
MT-XE	MT8121XE / MT8150XE / MT8090XE /

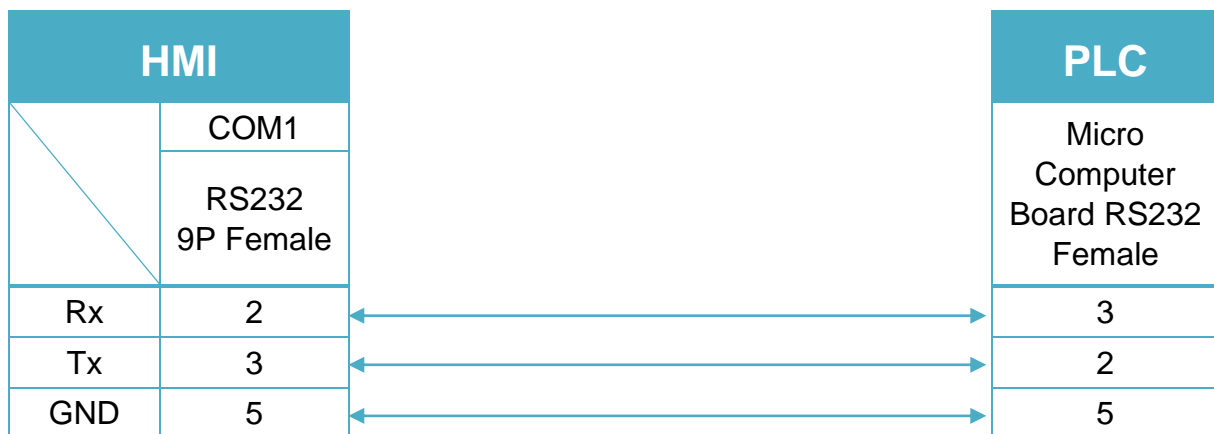
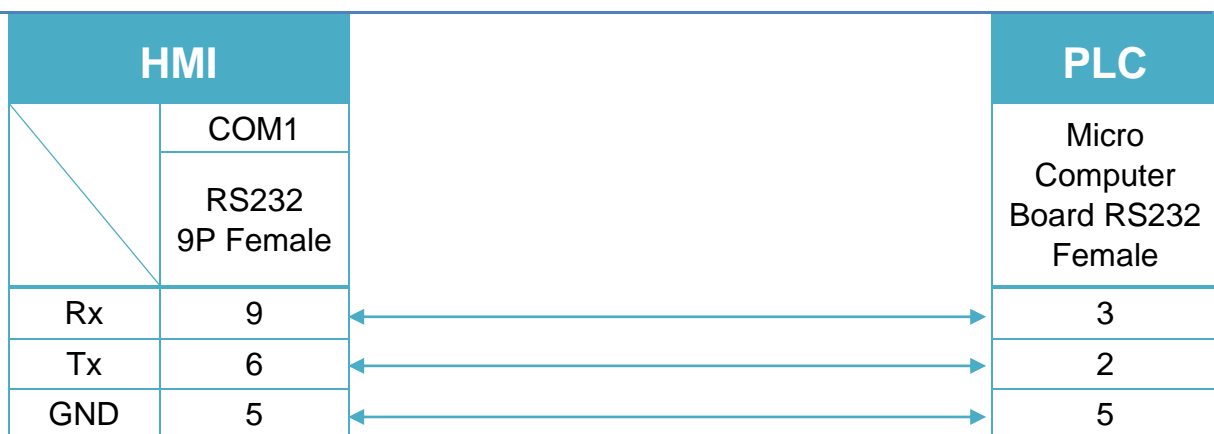


Diagram 3

MT-iE	MT8050iE
MT-iP	MT6051iP / MT6071iP / MT8071iP



Protocol:

Read Command:

PC → HMI

02	'0'	Read address	Size	CR
----	-----	--------------	------	----

02	30	30	30	30	30	30	30	32	0D
----	----	----	----	----	----	----	----	----	----

Read RW0 1 word (2 bytes) STX = 0x02, '0' = Read command, CR = 0x0D

Read address (hexadecimal)

0 ~ FFFF = RW0 ~ 65535

Size (hexadecimal)

2 ~ FE = 2 ~ 254 bytes = 1 ~ 127 word.

Size must be even.

HMI → PC (response)

02	Data1	Data2	CR
----	-------	-------	-------	----

02	30	30	31	30	0D
----	----	----	----	----	----

RW0 = 0x0010 = 16

Write Command:

PC → HMI

02	'1'	Read address	Size	Data1	Data2		CR
----	-----	--------------	------	-------	-------	--	----

02	31	30	30	30	30	30	32	12	34	0D
----	----	----	----	----	----	----	----	----	----	----

Write RW0 = 0x1234

Read address (hexadecimal)

0 ~ FFFF = RW0 ~ 65535

Size (hexadecimal)

2 ~ FE = 2 ~ 254 bytes = 1 ~ 127 word.

Size must be even.

HMI → PC (response)

06

ACK = 0x06

Mitsubishi FX0S/FX0N/FX1S/FX1N/FX2

Supported Series: Mitsubishi FX0S/FX0N/FX1S/FX1N/FX2/FX3S

Website: <http://www.mitsubishi-automation.com>

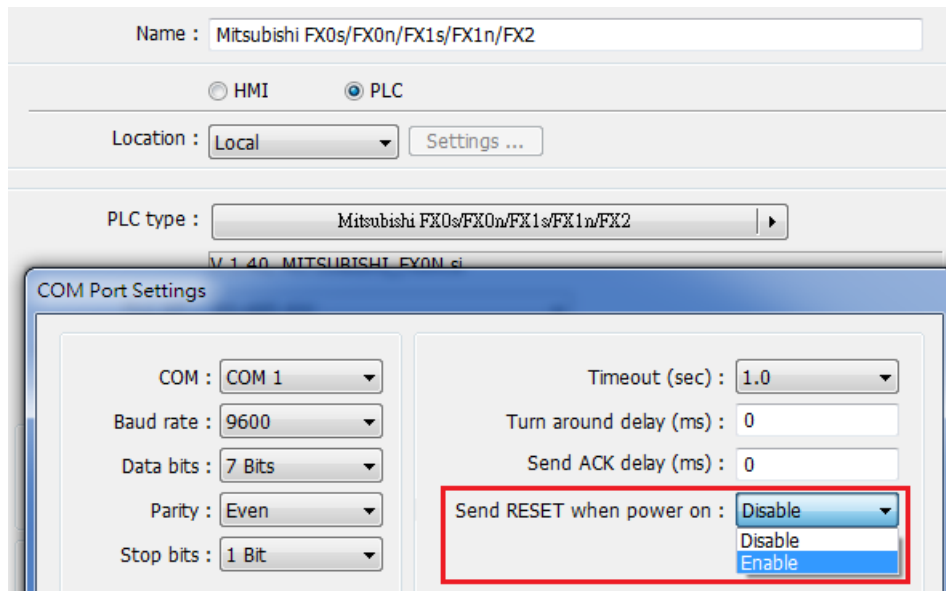
HMI Setting:

Parameters	Recommended	Options	Notes
PLC type	Mitsubishi FX0S/FX0N/FX1S/FX1N/FX2		
PLC I/F	RS485 4W	RS232/RS485	
Baud rate	9600	9600/19200/38400/57600/115200	
Data bits	7	7,8	
Parity	Even	Even, Odd, None	
Stop bits	1	1,2	
PLC sta. no.	0	0-255	

*Support communications between HMI and PLC in pass-through mode

*Set LW-9903 to 2 to enhance the speed of download/upload PLC program in pass-through mode

*[Send RESET when power on] selection is provided in PLC COM Port Settings. If enabled, PLC can be reset when HMI is powered ON.



Device Address:

Bit/Word	Device type	Format	Range	Memo
B	X	OOO	0 ~ 377	Input Relay
B	Y	OOO	0 ~ 377	Output Relay
B	M	DDDD	0 ~ 9999	Auxiliary Relay
B	T	DDD	0 ~ 255	Timer Relay
B	C	DDD	0 ~ 255	Counter Relay
B	SM	DDDD	8000 ~ 9999	Special Aux. Relays
B	D_Bit	DDDDdd	0 ~ 999915	Data Register Bit (D)
B	S	DDDD	0 ~ 4095	States
W	TV	DDD	0 ~ 255	Timer Memory
W	CV	DDD	0 ~ 199	Counter Memory
W	D	DDDD	0 ~ 9999	Data Register
DW	CV2	DDD	200 ~ 255	Counter Memory(D Word)
W	SD	DDDD	8000 ~ 9999	Special Data Register

Wiring Diagram:

RS422 Port 8P Mini-Din Male (Diagram 1 ~ Diagram 4)

The following is the view from the soldering point of a connector.

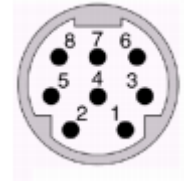


Diagram 1

cMT Series	cMT3151
eMT Series	eMT3070 / eMT3105 / eMT3120 / eMT3150
MT-iE	MT8070iE / MT6070iE / MT8100iE / MT8121iE / MT8150iE
MT-XE	MT8121XE / MT8150XE

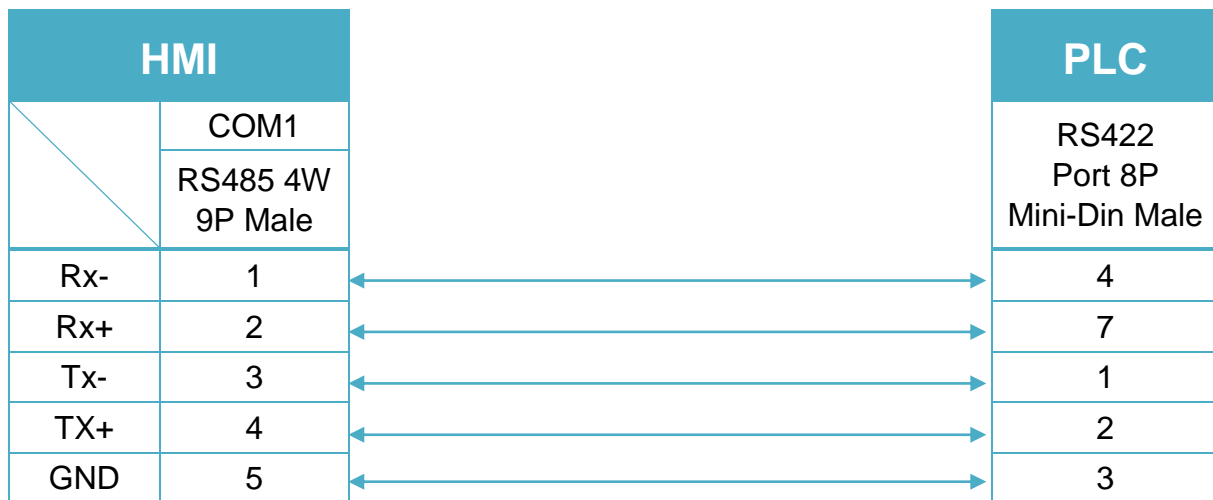


Diagram 2

cMT Series *cMT-SVR*

mTV *mTV*

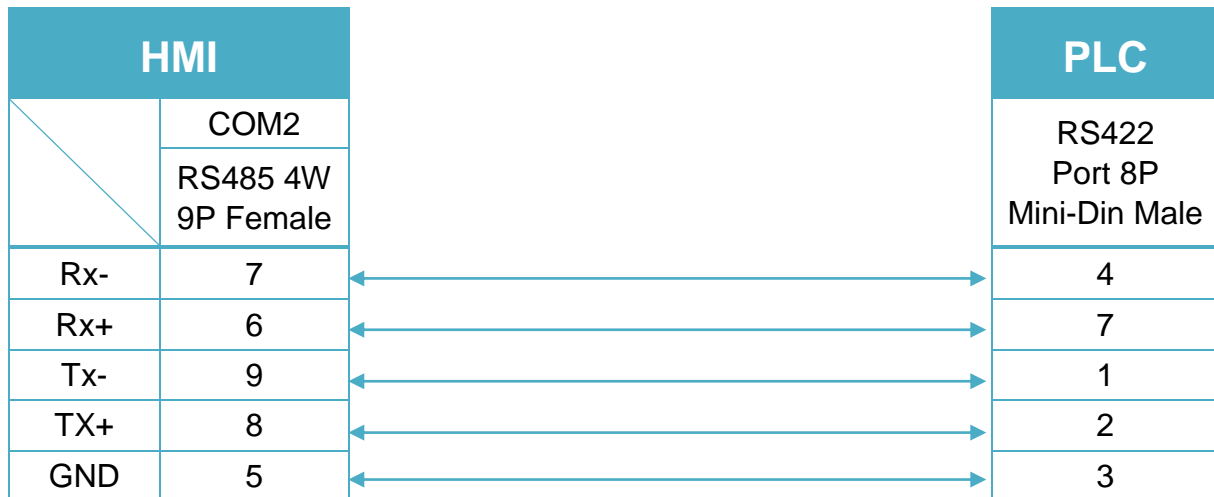


Diagram 3

MT-iE *MT8071iE / MT6071iE / MT8072iE / MT6072iE / MT8073iE /
MT8101iE / MT8102iE / MT8103iE*

MT-XE *MT8090XE / MT8092XE*

MT-iP *MT6071iP / MT8071iP / MT6103iP*

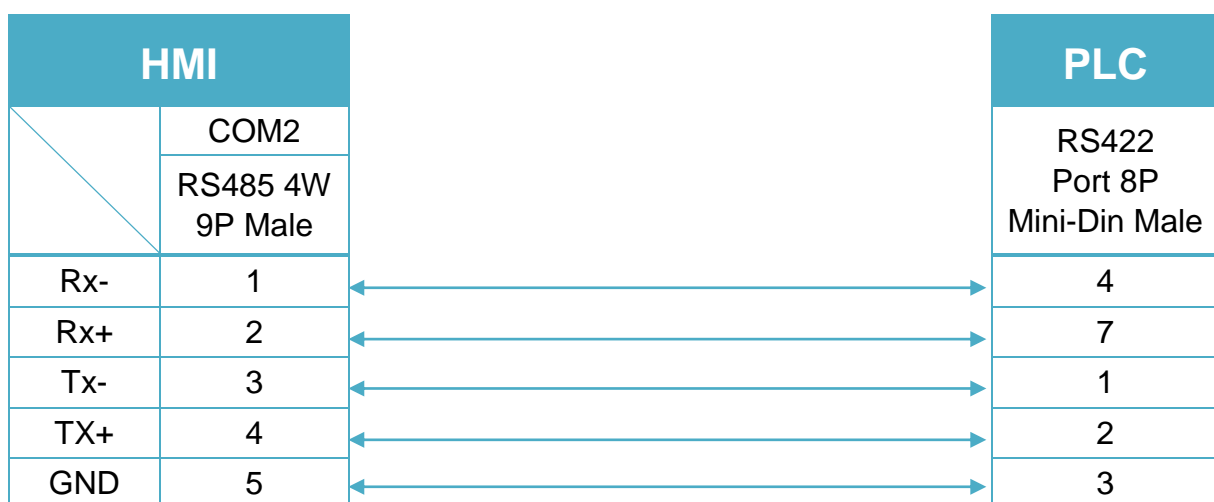
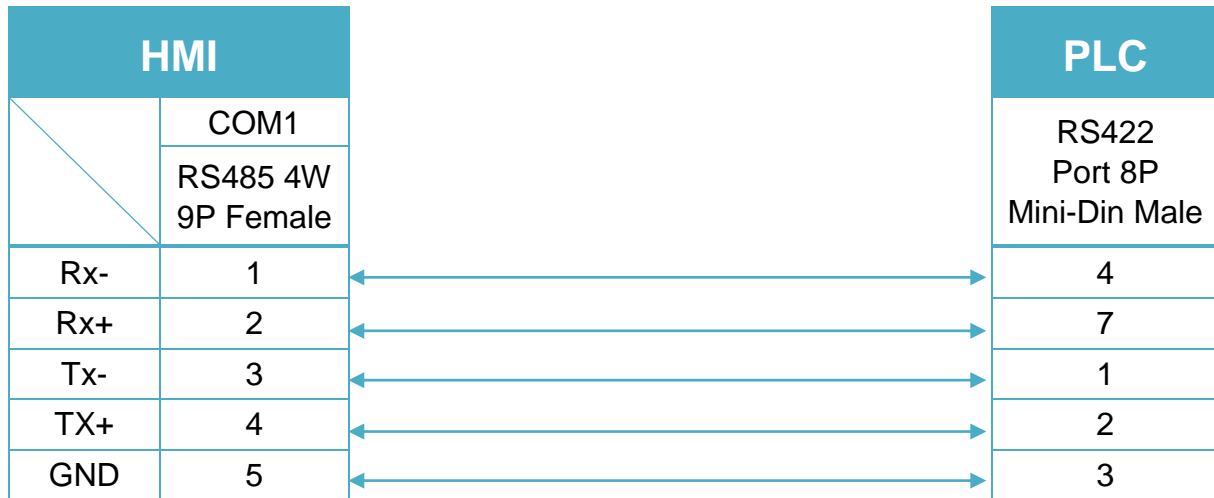


Diagram 4
MT-iE *MT8050iE*
MT-iP *MT6051iP*


RS422 Port 25P D-Sub Male (Diagram 5 ~ Diagram 8)

Diagram 5

cMT Series	<i>cMT3151</i>
eMT Series	<i>eMT3070 / eMT3105 / eMT3120 / eMT3150</i>
MT-iE	<i>MT8070iE / MT6070iE / MT8100iE / MT8121iE / MT8150iE</i>
MT-XE	<i>MT8121XE / MT8150XE</i>

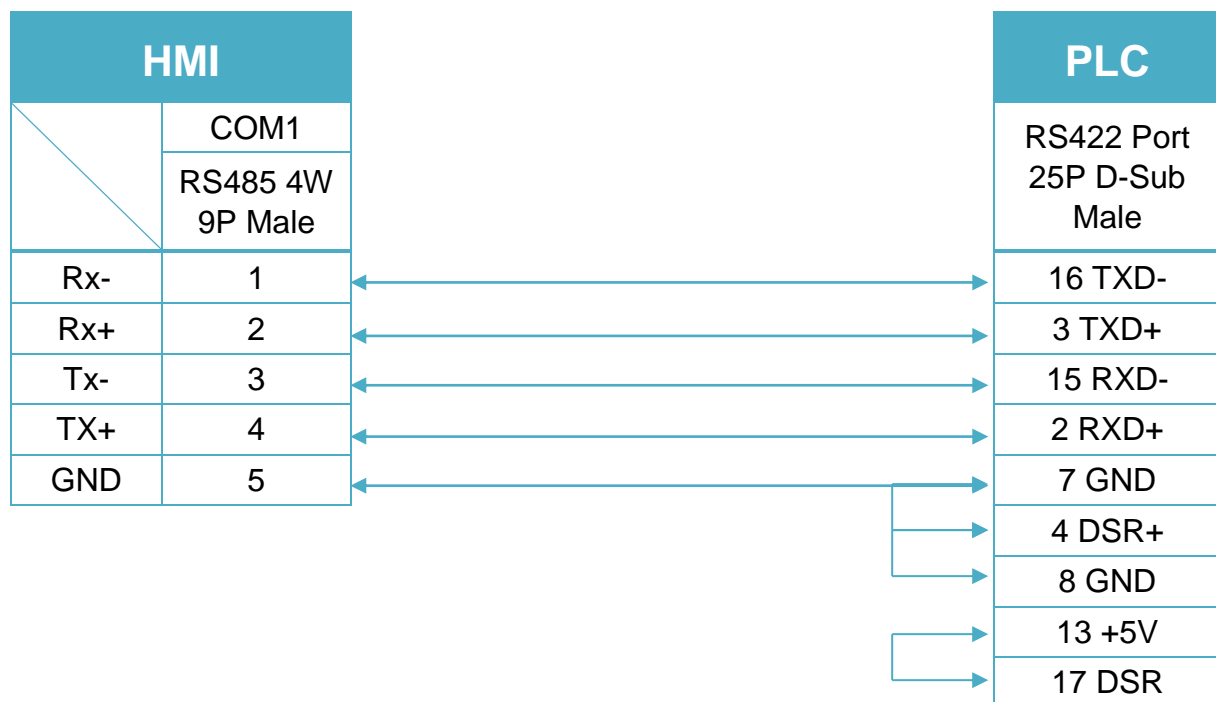


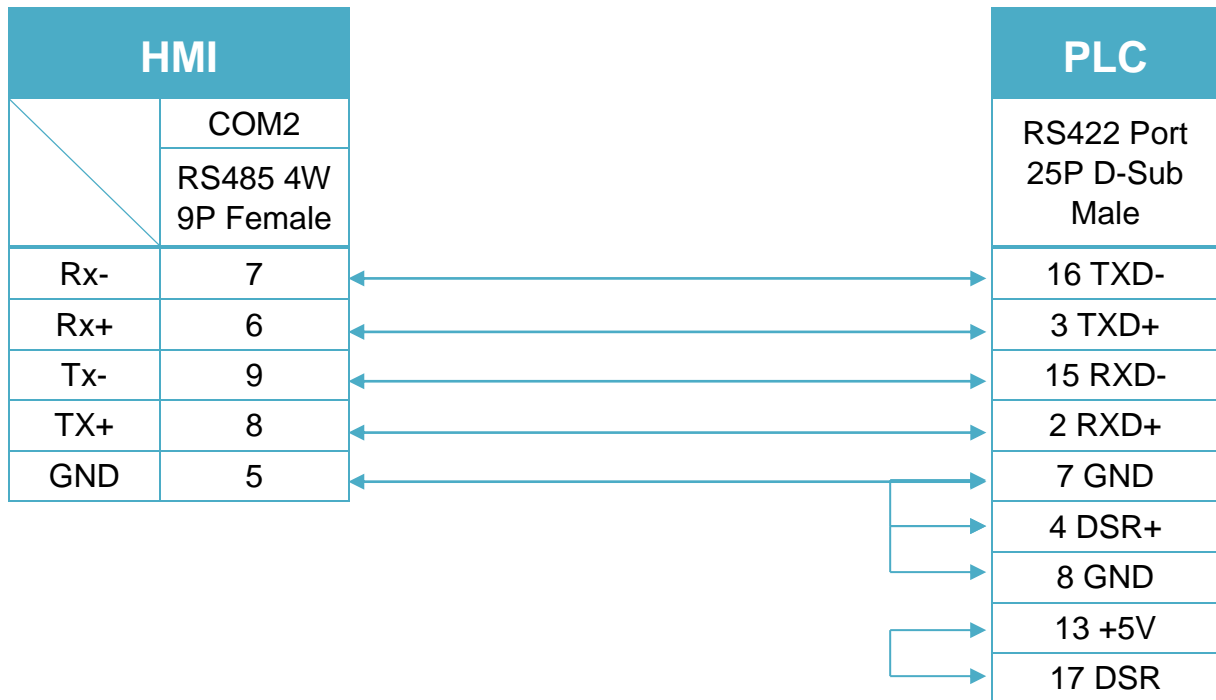
Diagram 6
cMT Series
cMT-SVR
mTV
mTV


Diagram 7

MT-iE	<i>MT8071iE / MT6071iE / MT8072iE / MT6072iE / MT8073iE / MT8101iE / MT8102iE / MT8103iE</i>
MT-XE	<i>MT8090XE / MT8092XE</i>
MT-iP	<i>MT6071iP / MT8071iP / MT6103iP</i>

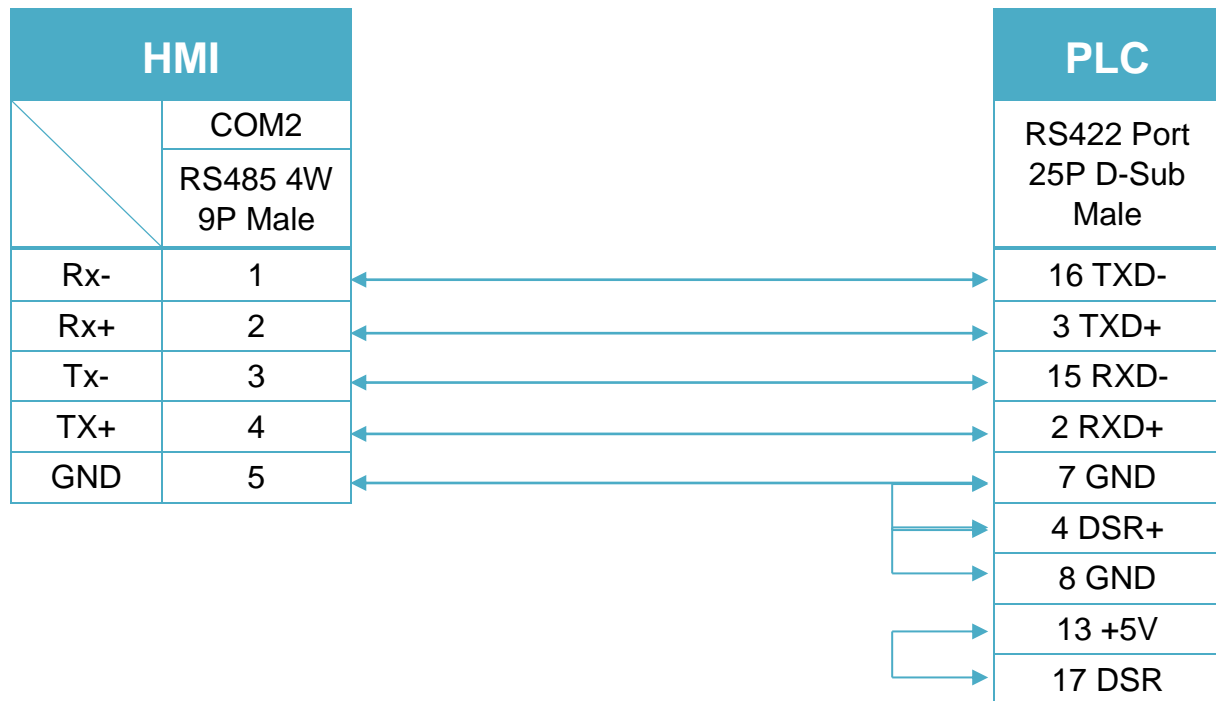
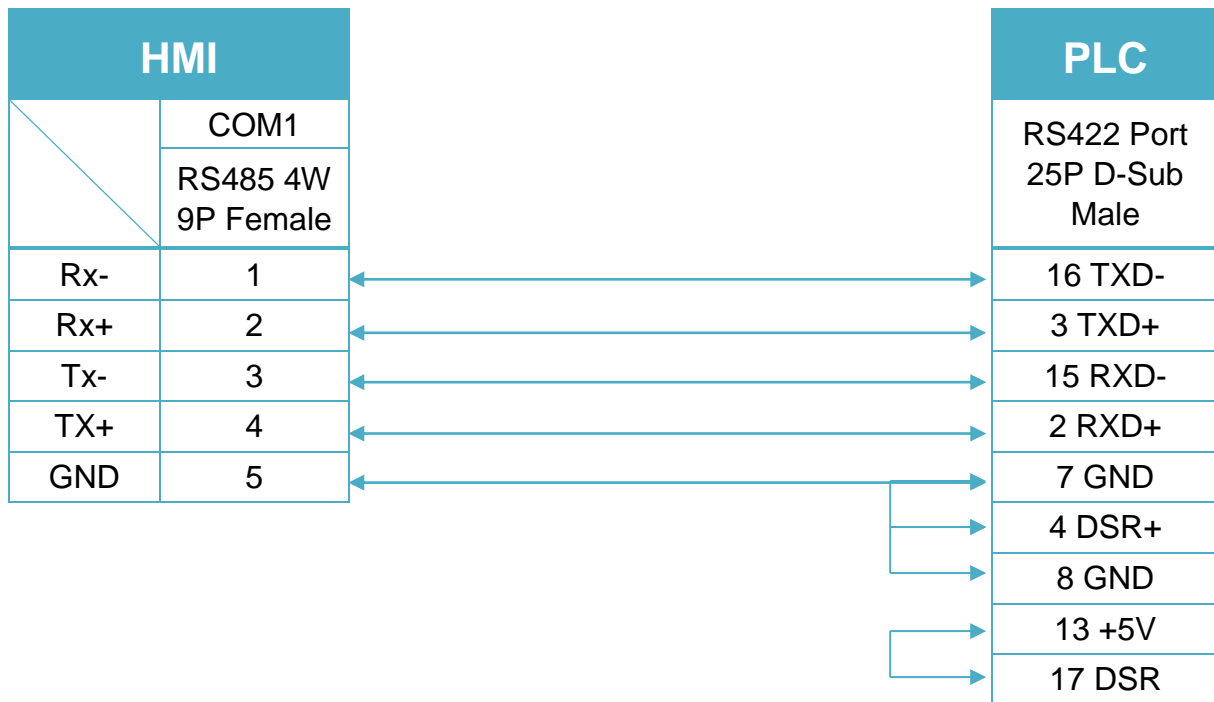


Diagram 8

MT-iE *MT8050iE*

MT-iP *MT6051iP*



Mitsubishi FX232/485BD

Supported Series: Mitsubishi FX0N/FX2/FX2N COM for Communication Module BD
 FX2N-485-BD, FX2N-232-BD, FX1N-485-BD, FX1N-232-BD & FX3U-485ADP.

Website: <http://www.mitsubishi-automation.com>

HMI Setting:

Parameters	Recommended	Options	Notes
PLC type	Mitsubishi FX232/485BD		
PLC I/F	RS232/RS485	RS232/RS485 2w/4w	in accordance with the BD module
Baud rate	19200	9600/19200/38400	
Data bits	7	7,8	
Parity	Even	Even, Odd, None	
Stop bits	1	1,2	
PLC sta. no.	1	0-15	

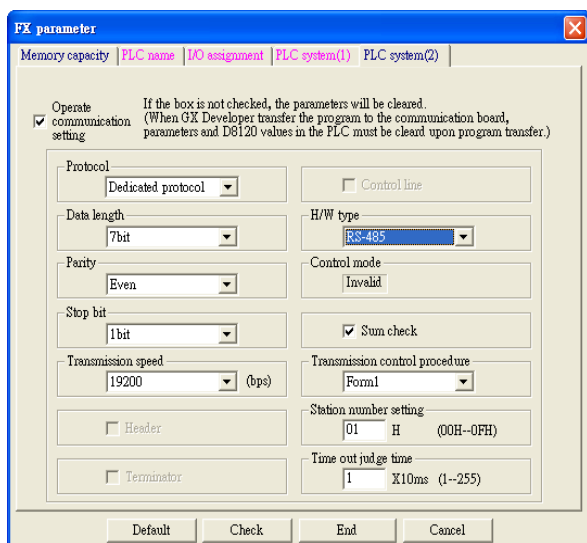
Note: It is recommended to set turn around delay to 8. (For RS485 2W)

Online simulator	YES	Extend address mode	YES
-------------------------	-----	----------------------------	-----

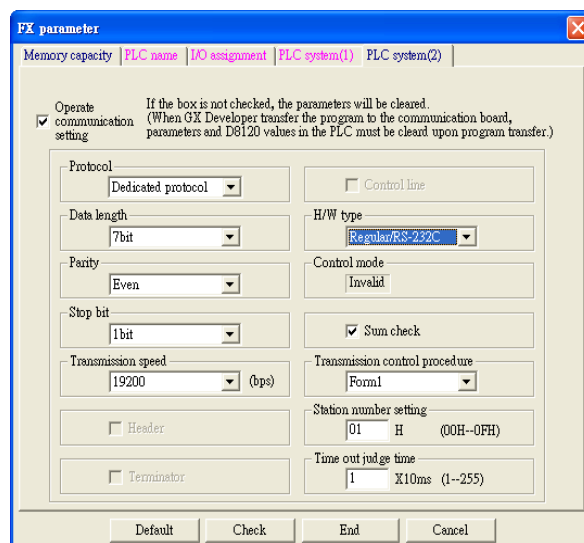
PLC Setting:

Communication mode	Must set PLC station when using BD Module.
---------------------------	--

Register D8120 setting: set b9 and b8 of BFM#0 to 0.



FX2N-485-BD, FX1N-485-BD



FX2N-232-BD, FX1N-232-BD

Device Address:

Bit/Word	Device type	Format	Range	Memo
B	X	OOO	0 ~ 377	Input Relay
B	Y	OOO	0 ~ 377	Output Relay
B	M	DDDD	0 ~ 7999	Auxiliary Relay
B	T	DDD	0 ~ 511	Timer Relay
B	C	DDD	0 ~ 255	Counter Relay
B	SM	DDDD	8000 ~ 9999	Special Auxiliary Relay
B	D_Bit	DDDDh	0 ~ 7999f	Data Register Bit
B	S	DDDD	0 ~ 4095	State Relay
W	TV	DDD	0 ~ 511	Timer Memory
W	CV	DDD	0 ~ 199	Counter Memory
W	D	DDDD	0 ~ 7999	Data Register
W	CV2	DDD	200 ~ 255	Counter Memory(D Word)
W	SD	DDDD	8000 ~ 9999	Special Data Register
W	R	DDDDD	0 ~ 32767	Extended Register

Wiring Diagram:

Communication Module RS232-BD (Diagram 1 ~ Diagram 3)

Diagram 1

cMT Series	<i>cMT3151</i>
eMT Series	<i>eMT3070 / eMT3105 / eMT3120 / eMT3150</i>
MT-iE	<i>MT8073iE / MT8102iE</i>
MT-XE	<i>MT8092XE</i>
MT-iP	<i>MT6103iP</i>

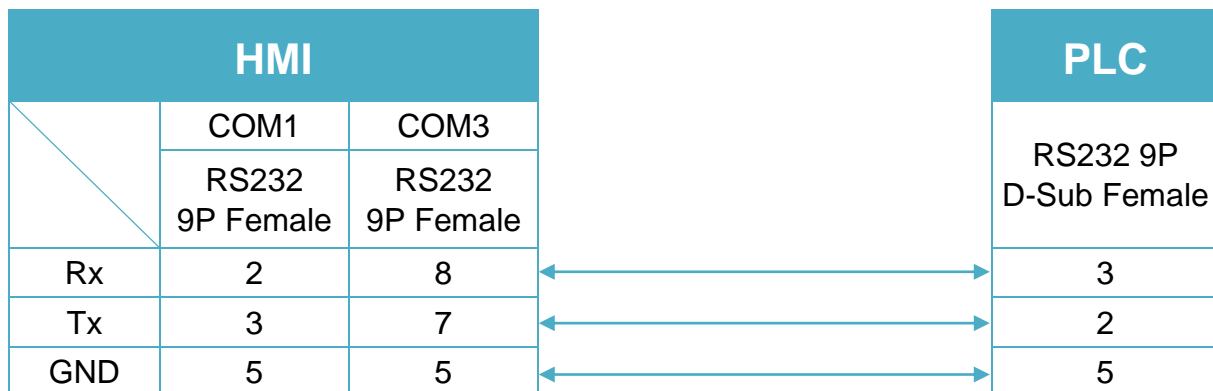


Diagram 2

cMT Series	<i>cMT-SVR</i>
mTV	<i>mTV</i>
MT-iE	<i>MT8070iE / MT6070iE / MT8100iE / MT8121iE / MT8150iE / MT8071iE / MT6071iE / MT8072iE / MT6072iE / MT8073iE / MT8101iE / MT8102iE / MT8103iE</i>
MT-XE	<i>MT8121XE / MT8150XE / MT8090XE /</i>

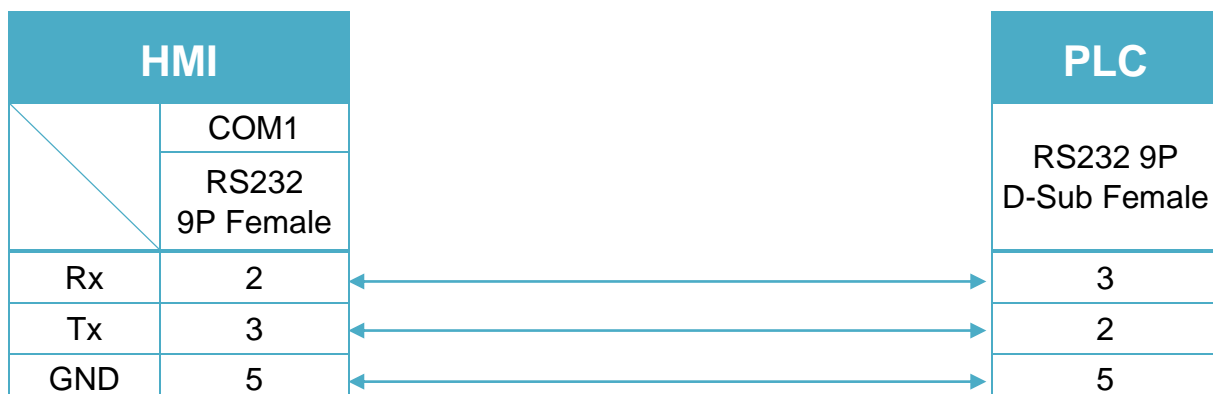


Diagram 3

MT-iE
MT8050iE
MT-iP
MT6051iP / MT6071iP / MT8071iP


Communication Module RS485BD: RS485 4W (Diagram 4 ~ Diagram 7)

Diagram 4

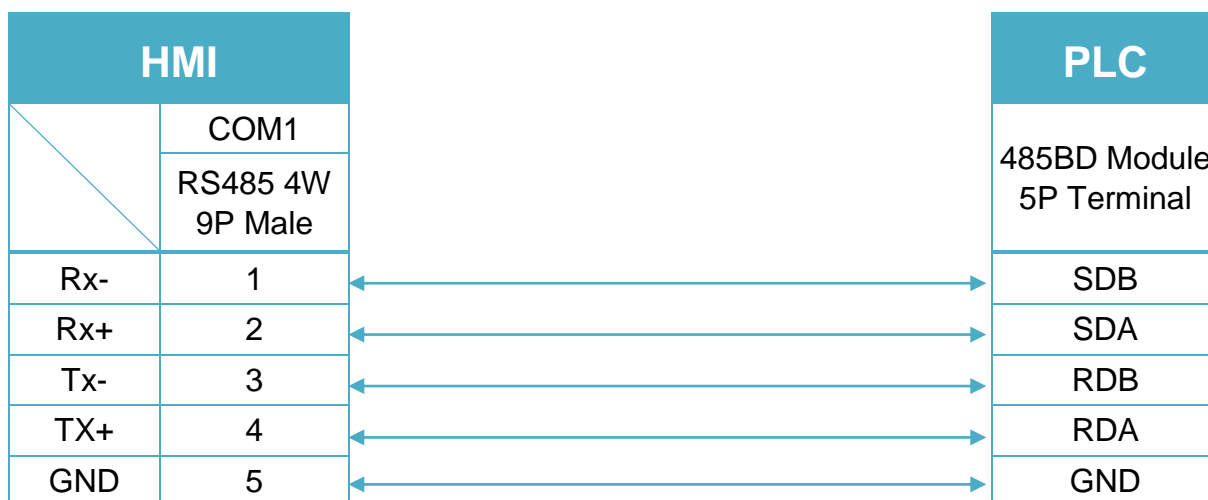
cMT Series
cMT3151
eMT Series
eMT3070 / eMT3105 / eMT3120 / eMT3150
MT-iE
MT8070iE / MT6070iE / MT8100iE / MT8121iE / MT8150iE
MT-XE
MT8121XE / MT8150XE


Diagram 5

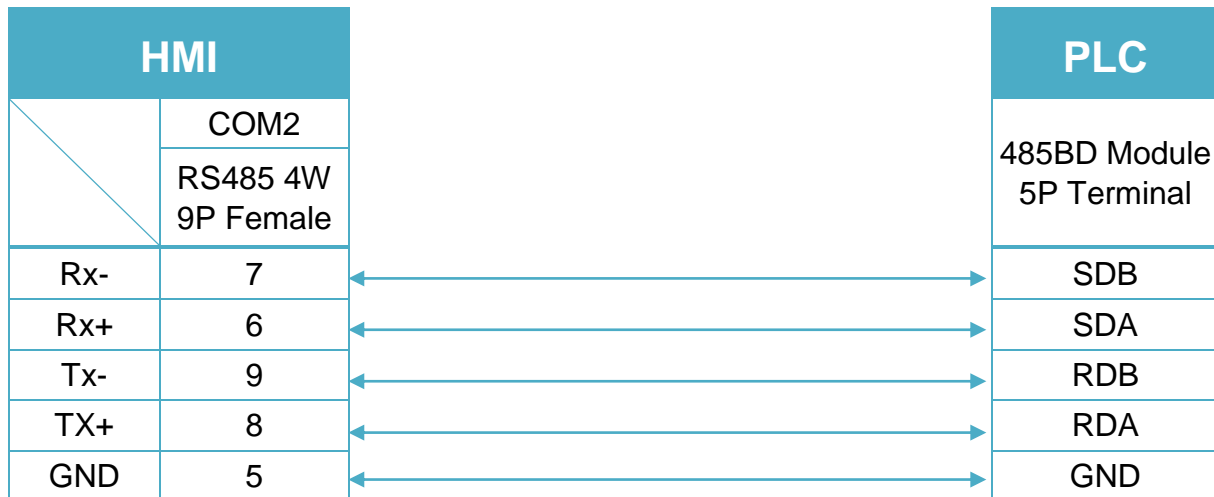
cMT Series *cMT-SVR*
mTV *mTV*


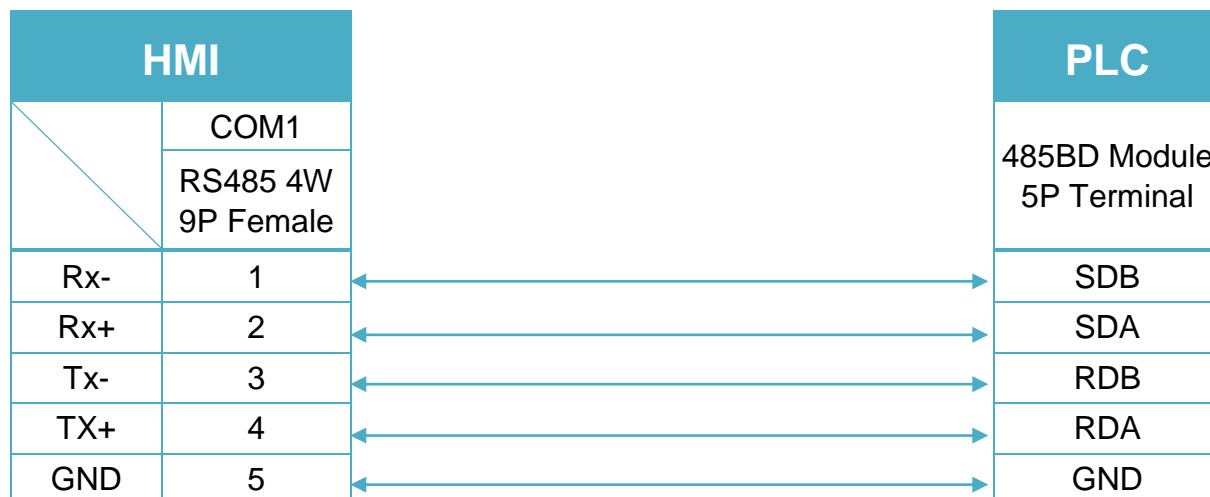
Diagram 6

MT-iE *MT8071iE / MT6071iE / MT8072iE / MT6072iE / MT8073iE /
MT8101iE / MT8102iE / MT8103iE*
MT-XE *MT8090XE / MT8092XE*
MT-iP *MT6071iP / MT8071iP / MT6103iP*


Diagram 7

MT-iE *MT8050iE*

MT-iP *MT6051iP*



Communication Module RS485BD: RS485 2W (Diagram 8 ~ Diagram 13)

Diagram 8

cMT Series *cMT3151*

eMT Series *eMT3070/ eMT3105 / eMT3120 / eMT3150*

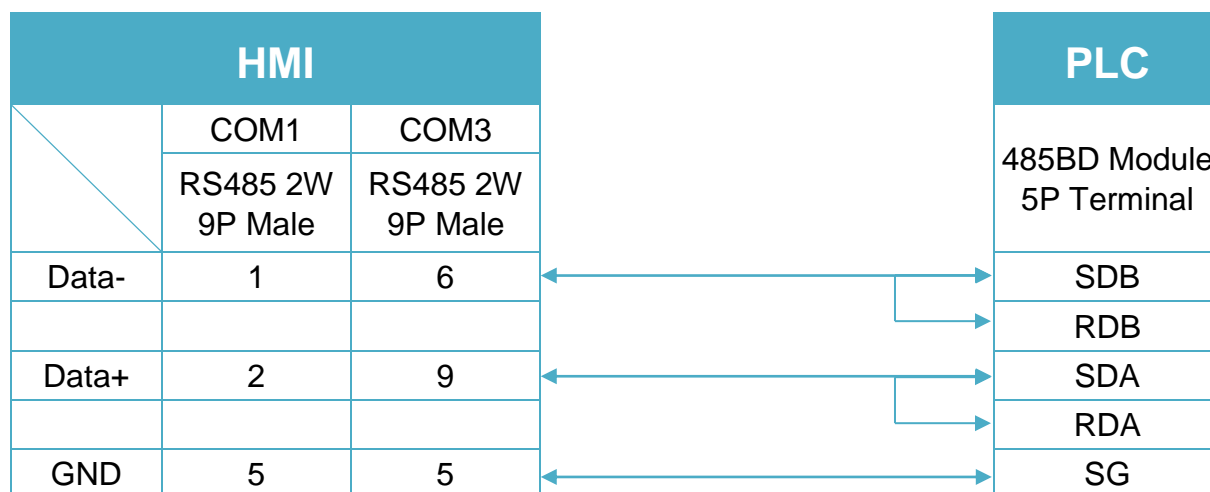


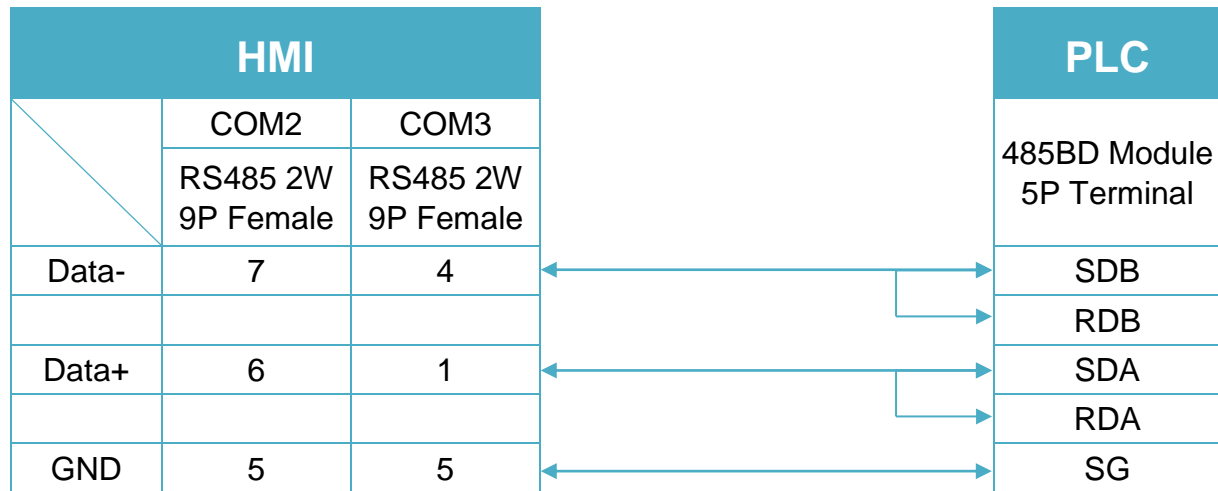
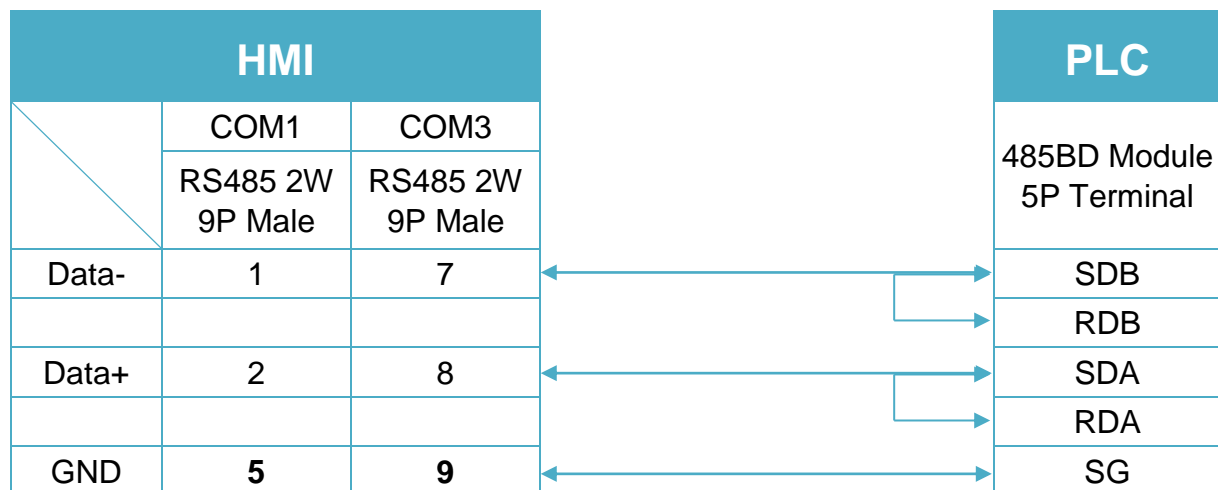
Diagram 9
cMT Series *cMT-SVR*
mTV *mTV*

Diagram 10
MT-iE *MT8070iE / MT6070iE / MT8100iE / MT8121iE / MT8150iE*
MT-XE *MT8121XE / MT8150XE*


Diagram 11

MT-iE	<i>MT8071iE / MT6071iE / MT8072iE / MT6072iE / MT8073iE / MT8101iE / MT8102iE / MT8103iE</i>
MT-XE	<i>MT8090XE / MT8092XE</i>
MT-iP	<i>MT6103iP</i>

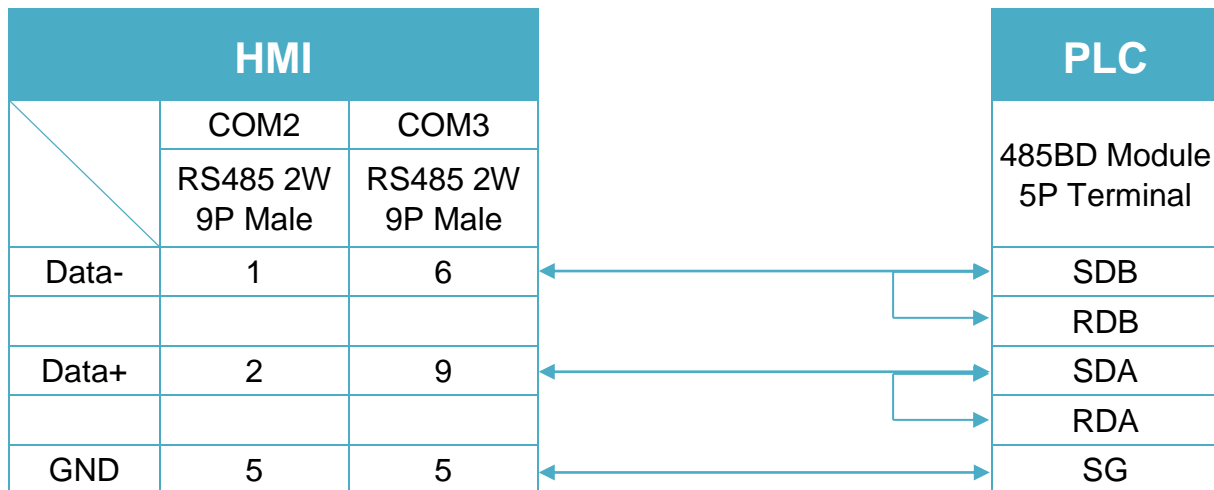


Diagram 12

MT-iE	<i>MT8050iE</i>
MT-iP	<i>MT6051iP</i>

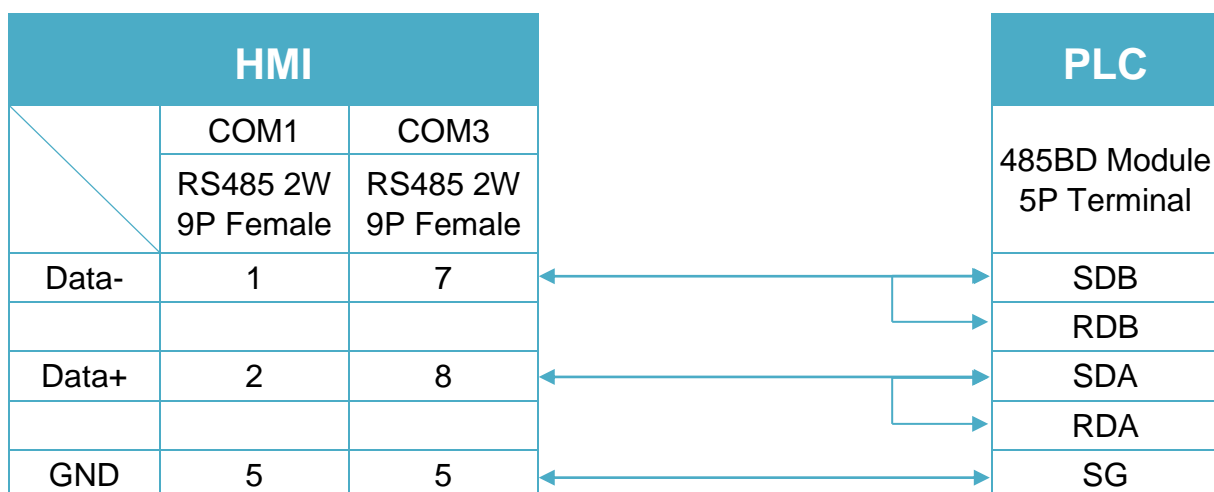


Diagram 13

MT-iP
MT6071iP / MT8071iP


Mitsubishi FX2N

Supported Series: Mitsubishi FX2N series PLC

Website <http://www.mitsubishi-automation.com>

HMI Setting:

Parameters	Recommended	Options	Notes
PLC type	Mitsubishi FX2N		
PLC I/F	RS485 4W	RS232/RS485	
Baud rate	19200	9600/19200/38400 /57600/115200	
Data bits	7		
Parity	Even		
Stop bits	1		
PLC sta. no.	0		

Online simulator	YES	Extend address mode	NO
-------------------------	-----	----------------------------	----

*Support communications between HMI and PLC in pass-through mode

*Set LW-9903 to 2 to enhance the speed of download/upload PLC program in pass-through mode

Device Address:

Bit/Word	Device type	Format	Range	Memo
B	X	OOO	0 ~ 377	Input Relay
B	Y	OOO	0 ~ 377	Output Relay
B	M	DDDD	0 ~ 7999	Auxiliary Relay
B	T	DDD	0 ~ 255	Timer Relay
B	C	DDD	0 ~ 255	Counter Relay
B	SM	DDDD	8000 ~ 9999	Special Auxiliary Relay
B	D_Bit	DDDDdd	0 ~ 799915	Data Register Bit (D)
B	S	DDDD	0 ~ 4095	State Relay (S)
W	TV	DDD	0 ~ 255	Timer Memory
W	CV	DDD	0 ~ 199	Counter Memory
W	D	DDDD	0 ~ 7999	Data Register
DW	CV2	DDD	200 ~ 255	Counter Memory(D Word)
W	SD	DDDD	8000 ~ 9999	Special Data Register

Wiring Diagram:

The following is the view from the soldering point of a connector.

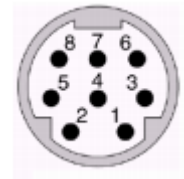


Diagram 1

cMT Series	<i>cMT3151</i>
eMT Series	<i>eMT3070 / eMT3105 / eMT3120 / eMT3150</i>
MT-iE	<i>MT8070iE / MT6070iE / MT8100iE / MT8121iE / MT8150iE</i>
MT-XE	<i>MT8121XE / MT8150XE</i>

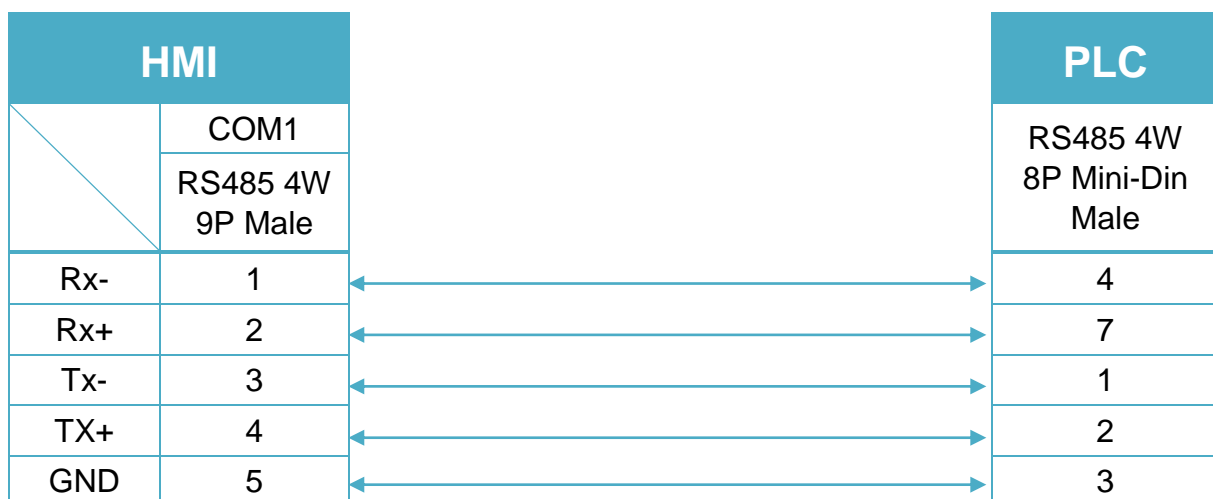


Diagram 2

cMT Series *cMT-SVR*

mTV *mTV*

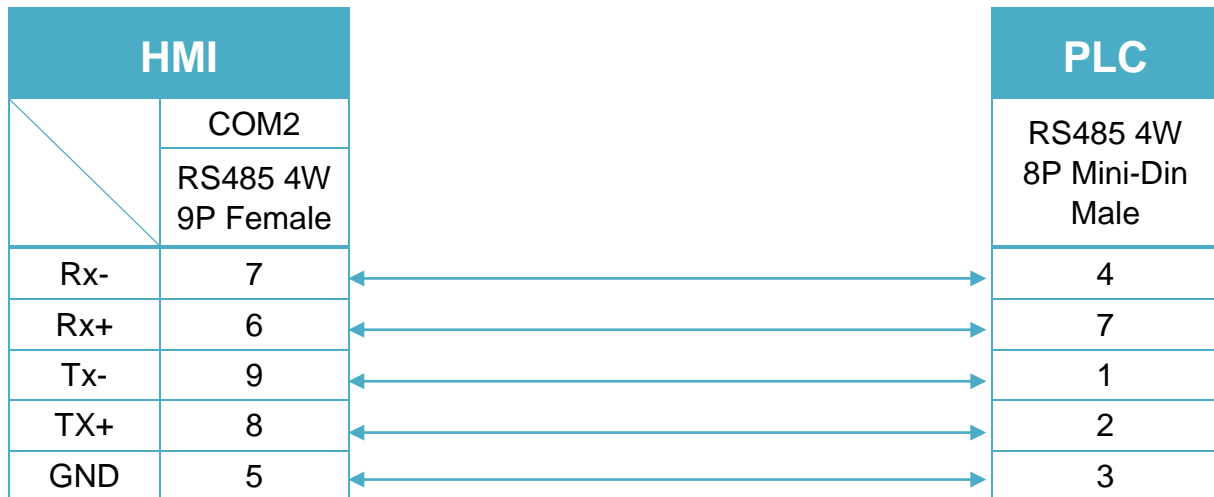


Diagram 3

MT-iE *MT8071iE / MT6071iE / MT8072iE / MT6072iE / MT8073iE /
MT8101iE / MT8102iE / MT8103iE*

MT-XE *MT8090XE / MT8092XE*

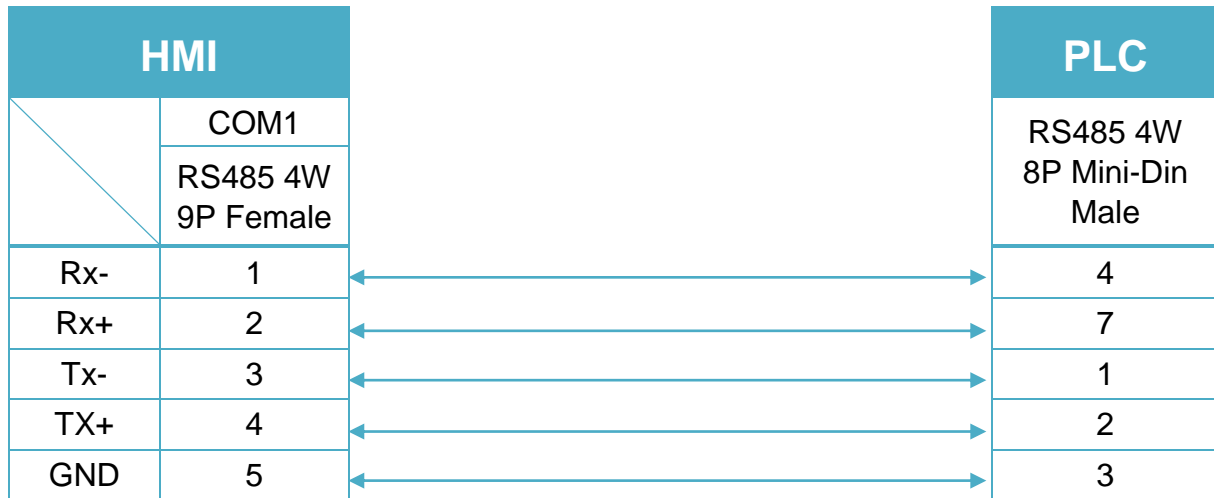
MT-iP *MT6071iP / MT8071iP / MT6103iP*



Diagram 4

MT-iE *MT8050iE*

MT-iP *MT6051iP*



Mitsubishi FX2N-10GM/20GM

Supported Series: Mitsubishi FX2N -10GM/20GM PLC.

Website <http://www.mitsubishi-automation.com>

HMI Setting:

Parameters	Recommended	Options	Notes
PLC type	Mitsubishi FX2N-10GM/20GM		
PLC I/F	RS485 4W		
Baud rate	9600		
Data bits	8		
Parity	Even		
Stop bits	1		
PLC sta. no.	0		

Online simulator	YES	Extend address mode	NO
-------------------------	-----	----------------------------	----

*Support communications between HMI and PLC in pass-through mode

*Set LW-9903 to 2 to enhance the speed of download/upload PLC program in pass-through mode

Device Address:

Bit/Word	Device type	Format	Range	Memo
B	X	OOO	0 ~ 103	Input Relay
B	Y	OOO	0 ~ 103	Output Relay
B	M	DDD	0 ~ 511	Auxiliary Relay
B	SM	DDDD	9000 ~ 9175	Special Auxiliary Relay
W	X_W	OOO	0 ~ 103	
W	Y_W	OOO	0 ~ 103	
W	M_W	DDD	0 ~ 511	
W	SM_W	DDDD	9000 ~ 9175	
W	D	DDDD	0 ~ 6999	Data Register
W	SD	DDDD	9000 ~ 9599	Special Data Register
W	V	D	0 ~ 7	Index register
DW	Z	D	0 ~ 7	Index register

Wiring Diagram:

The following is the view from the soldering point of a connector.

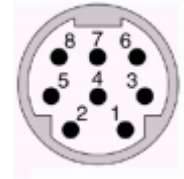


Diagram 1

cMT Series	<i>cMT3151</i>
eMT Series	<i>eMT3070 / eMT3105 / eMT3120 / eMT3150</i>
MT-iE	<i>MT8070iE / MT6070iE / MT8100iE / MT8121iE / MT8150iE</i>
MT-XE	<i>MT8121XE / MT8150XE</i>

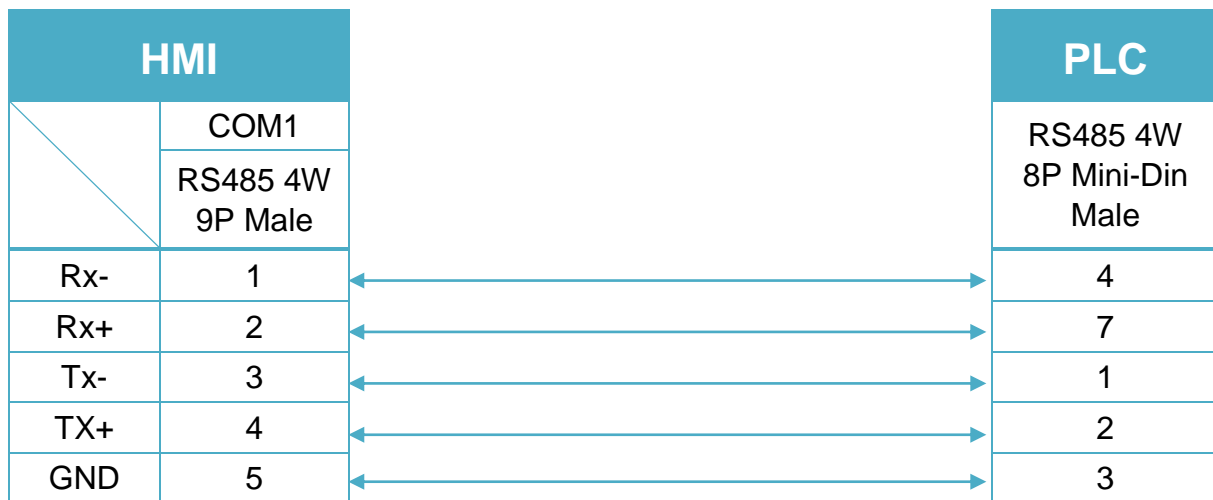


Diagram 2

cMT Series *cMT-SVR*

mTV *mTV*

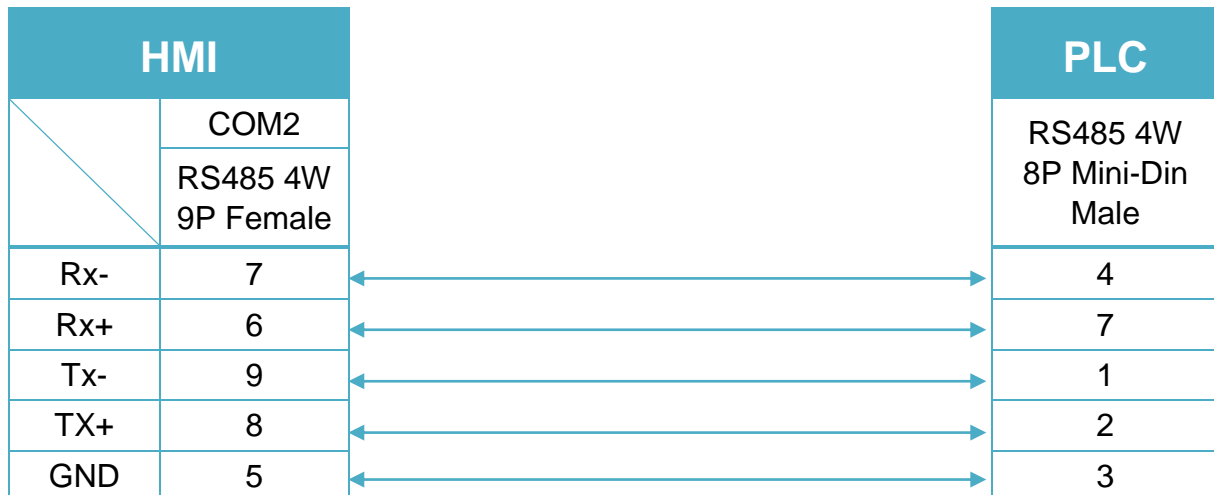


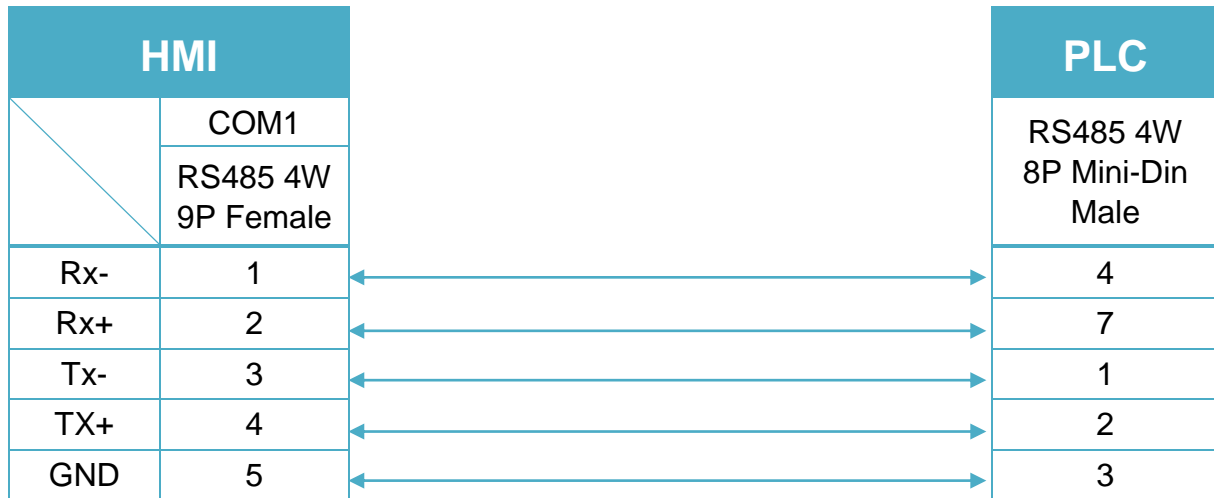
Diagram 3

MT-iE *MT8071iE / MT6071iE / MT8072iE / MT6072iE / MT8073iE /
MT8101iE / MT8102iE / MT8103iE*

MT-XE *MT8090XE / MT8092XE*

MT-iP *MT6071iP / MT8071iP / MT6103iP*



Diagram 4
MT-iE *MT8050iE*
MT-iP *MT6051iP*


Mitsubishi FX3U (Ethernet)

Supported Series: Mitsubishi FX SERIES, Module: FX3U-ENET.

Website: <http://www.mitsubishi-automation.com>

HMI Setting:

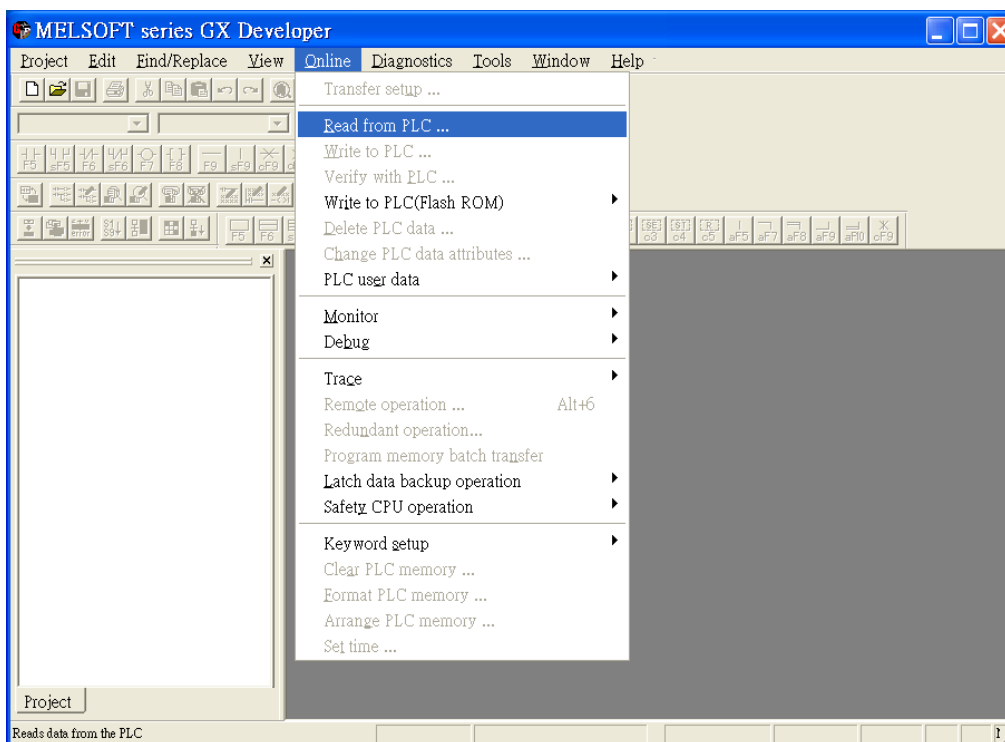
Parameters	Recommended	Options	Notes
PLC type	Mitsubishi FX3U (Ethernet)		
PLC I/F	Ethernet		
Port no.	5001(default)		Refer to Module Setting
PLC sta. no.	0 (default)		Refer to Module Setting

PLC Setting:

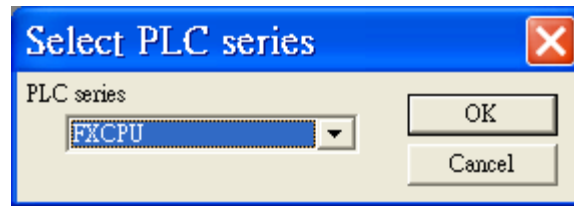
Fx3u-ENET module setting:

Before using Ethernet module, use GX Developer / FX Configurator-EN to set the Ethernet module, the FX3u-ENET module setting steps are shown below.

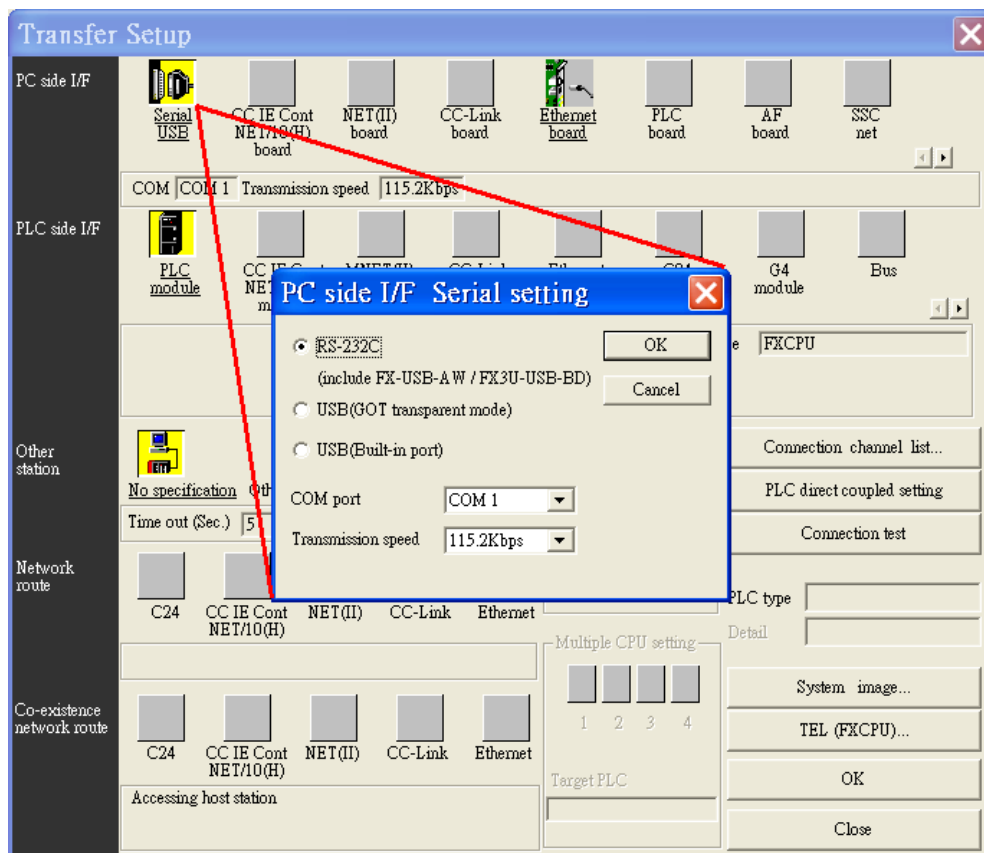
Step1. Open GX Developer, select “Read from PLC” in Online list.



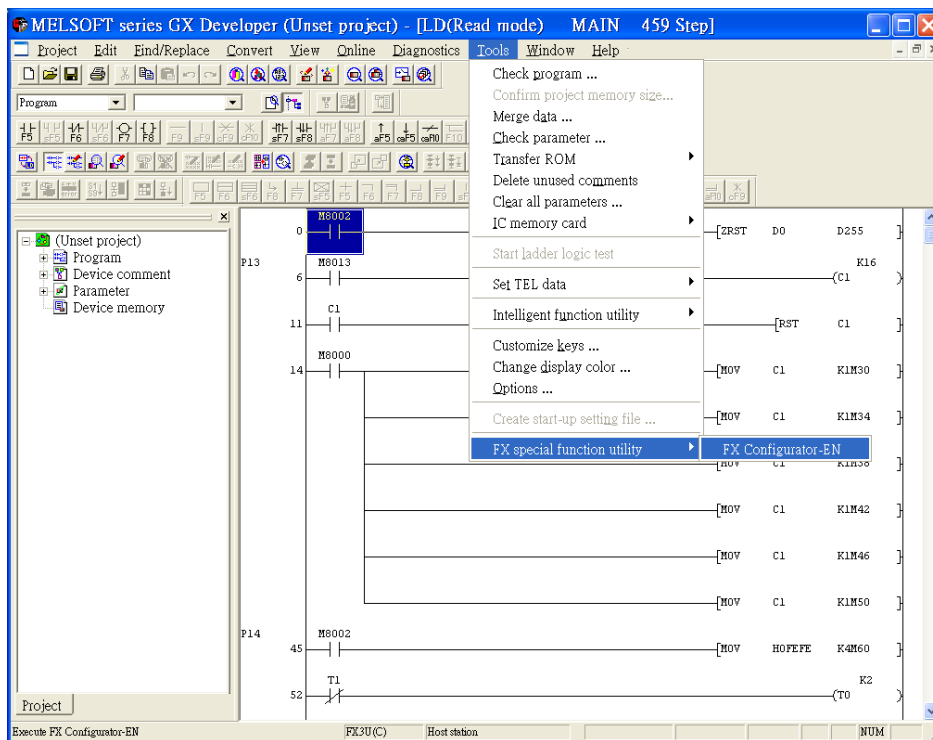
Step2. Select "FXCPU" in PLC series.



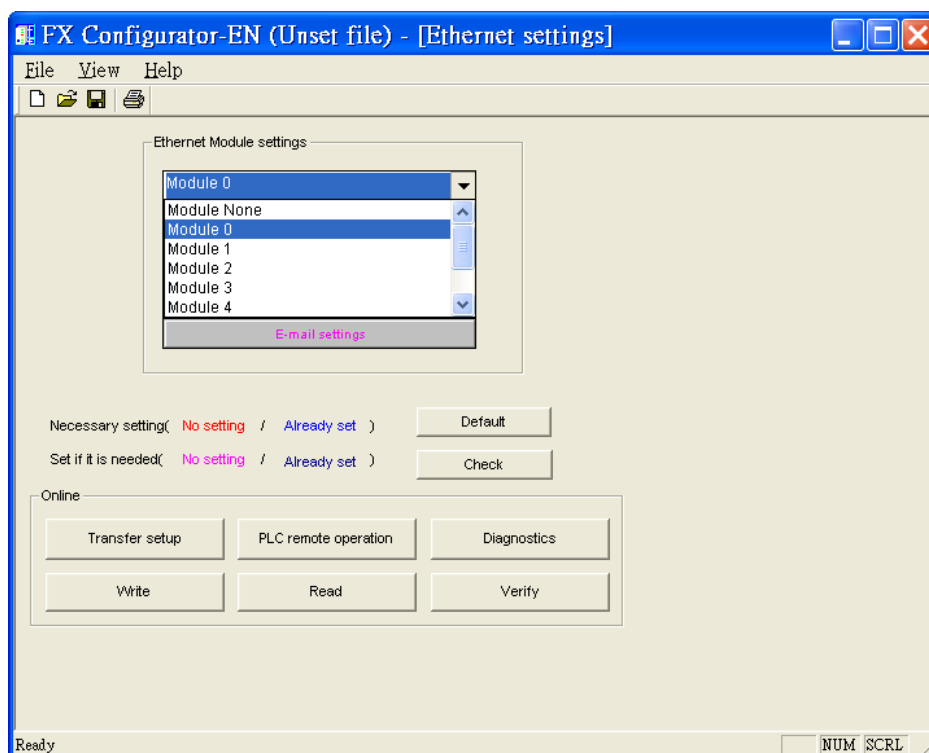
Step3. Connect PLC via serial port for setting IP address first.



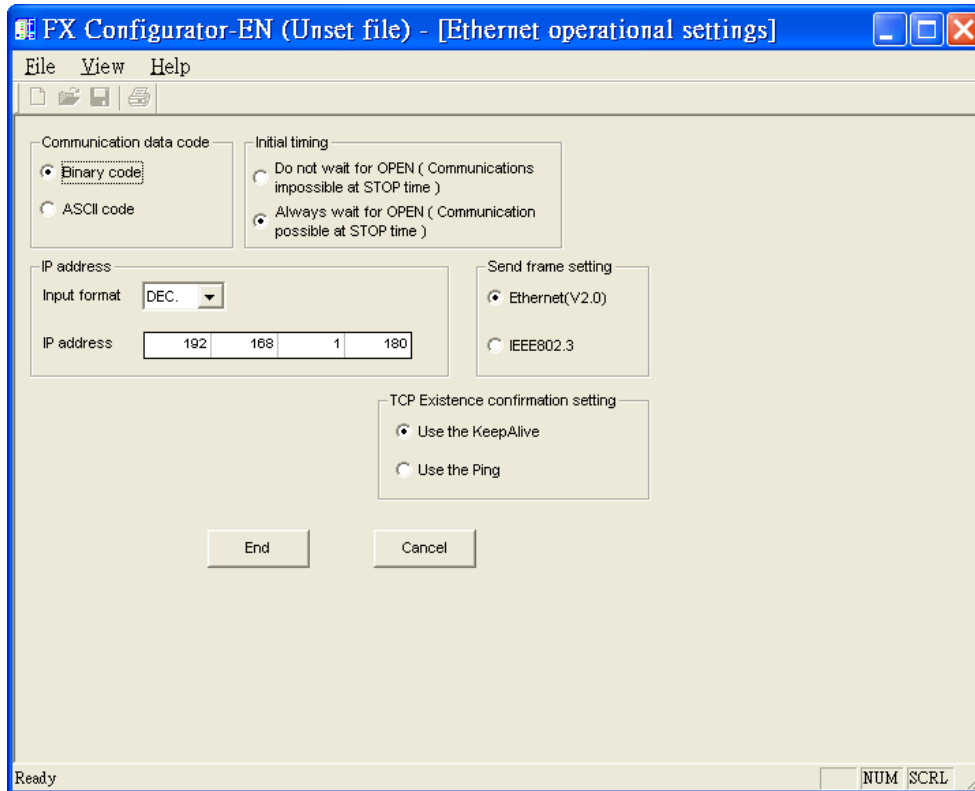
Step4. After finishing the PLC settings, select Tools/FX special function utility/FX Configurator-EN.



Step5. Select “Module 0” in Ethernet Module settings.
(If more than one module needed, please set modules step by step)



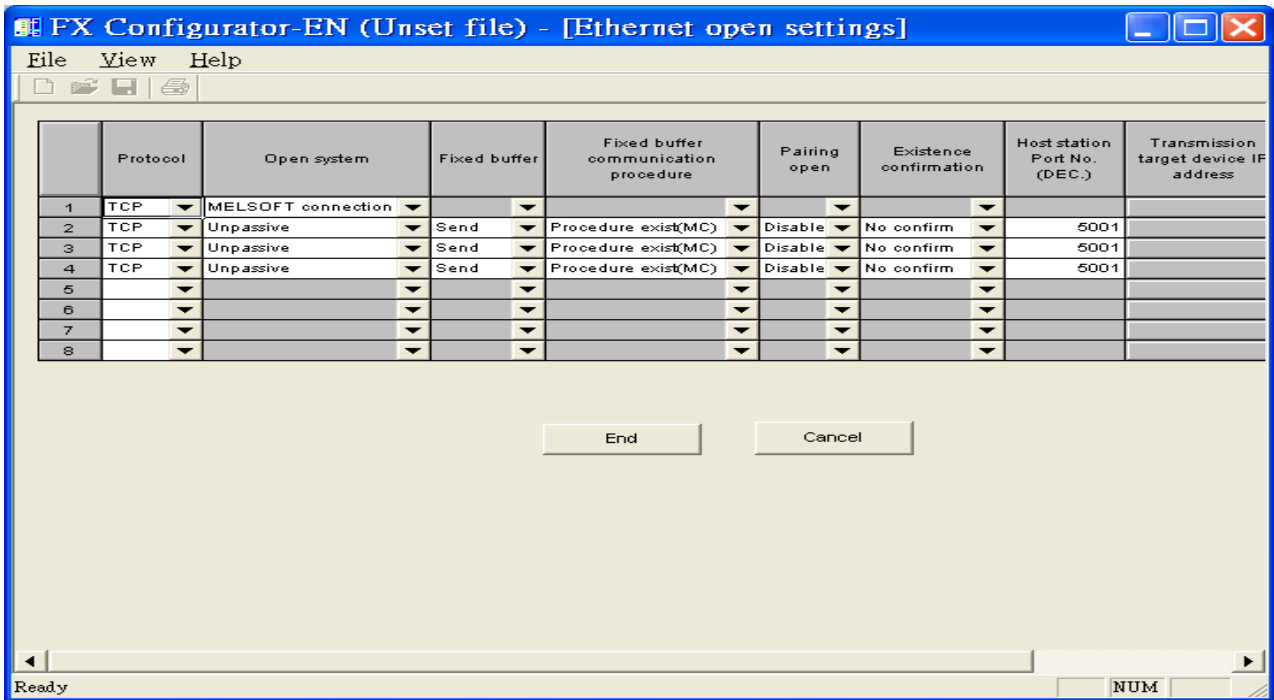
Step6. In Ethernet operational settings, select the related parameters and IP address and then press "End" to finish setting.



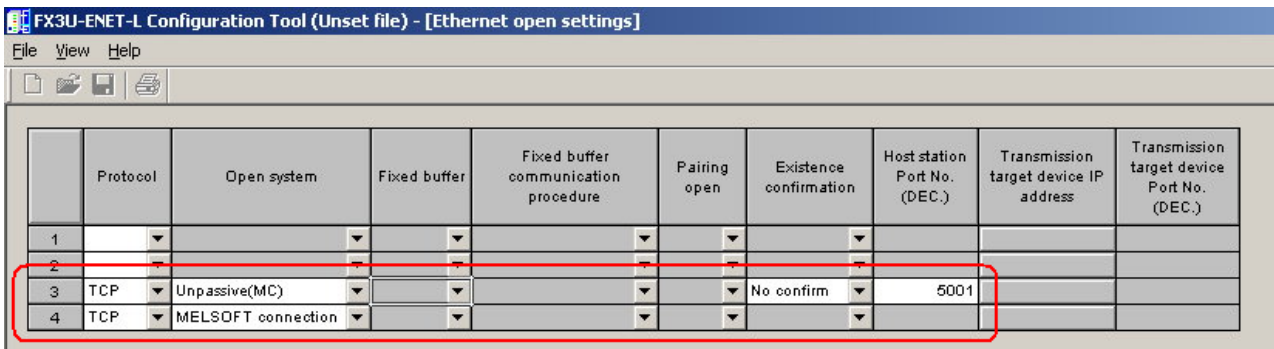
Step7. In Ethernet open settings, press "End" after setting the parameters below.

1	TCP	MELSOFT connection						
2	TCP	Unpassive	Send	Procedure exist(MC)	Disable	No confirm	5001	
3	TCP	Unpassive	Send	Procedure exist(MC)	Disable	No confirm	5001	
4	TCP	Unpassive	Send	Procedure exist(MC)	Disable	No confirm	5001	

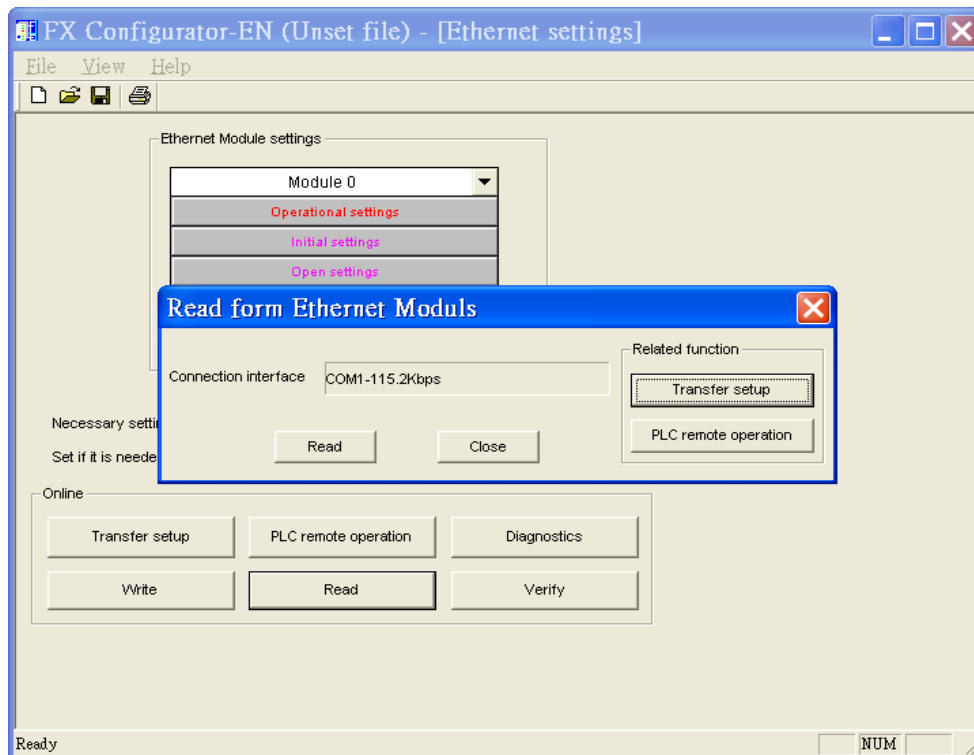
(The first Protocol means using GX Developer to communicate with module, the max. "Fixed buffer communication procedure" is 4 units.)



Or



Step8. After setting the parameters of PLC, restart for Ethernet communication.



Device Address:

Bit/Word	Device type	Format	Range	Memo
B	X	OOO	0 ~ 571	Input
B	Y	OOO	0 ~ 571	Output Relay
B	M	DDDD	0 ~ 7999	Internal Relay
B	T	DDD	0 ~ 511	Timer Contacts
B	C	DDD	0 ~ 255	Counter Contacts
B	SM	DDDD	8000 ~ 8511	Special Int. Relays
B	D_Bit	DDDDDDdd	0 ~ 1799915	Data Register Bit Access
B	S	DDDD	0 ~ 4095	Step Relays
W	TV	DDD	0 ~ 511	Timer Value
W	CV	DDD	0 ~ 199	Counter Value
W	D	DDDD	0 ~ 7999	Data Registers
W	CV2	DDD	200 ~255	Counter Value
W	SD	DDDD	8000 ~ 8511	Special Data Registers
W	R	DDDDDD	0 ~ 32767	File Register

Wiring Diagram:

Ethernet cable:



Mitsubishi FX3U/FX3G

Supported Series: Mitsubishi FX3U/FX3UC/FX3G/FX3S.

Website: <http://www.mitsubishi-automation.com>

HMI Setting:

Parameters	Recommended	Options	Notes
PLC type	Mitsubishi FX3U/FX3G		
PLC I/F	RS485 4w	RS232 / RS485 2w/4w / USB	
Baud rate	38400	9600/19200	
Data bits	7		
Parity	Even		
Stop bits	1		
PLC sta. no.	0		Does not apply to this protocol

Online simulator	YES (9600 baud rate only)	Extend address mode	NO
-------------------------	---------------------------	----------------------------	----

*Support communications between HMI and PLC in pass-through mode

*Set LW-9903 to 2 to enhance the speed of download/upload PLC program in pass-through mode

Device Address:

Bit/Word	Device	Format	Range	Memo
B	X	OOO	0 ~ 764	Input Relay
B	Y	OOO	0 ~ 764	Output Relay
B	M	DDDD	0 ~ 7999	Auxiliary Relay
B	T	DDD	0 ~ 511	Timer Relay (T)
B	C	DDD	0 ~ 255	Counter Relay (C)
B	SM	DDDD	8000 ~ 9999	Special Relay (M)
B	D_Bit	DDDDdd	0 ~ 799915	Data Register Bit (D)
B	S	DDDD	0 ~ 4095	State Relay (S)
W	TV	DDD	0 ~ 511	Timer Memory (T)
W	CV	DDD	0 ~ 199	Counter Memory (C)
W	D	DDDD	0 ~ 7999	Data Register (D)
DW	CV2	DDD	200 ~ 255	Counter Memory(D Word)
W	SD	DDDD	8000 ~ 9999	Special Data Register (D)

Bit/Word	Device	Format	Range	Memo
W	R	DDDDD	0 ~ 32767	Extended Register (R)
W	Z	D	0 ~ 7	Index register

Wiring Diagram:

The following is the view from the soldering point of a connector.

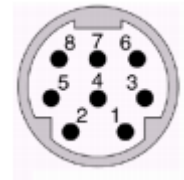


Diagram 1

cMT Series	<i>cMT3151</i>
eMT Series	<i>eMT3070 / eMT3105 / eMT3120 / eMT3150</i>
MT-iE	<i>MT8070iE / MT6070iE / MT8100iE / MT8121iE / MT8150iE</i>
MT-XE	<i>MT8121XE / MT8150XE</i>

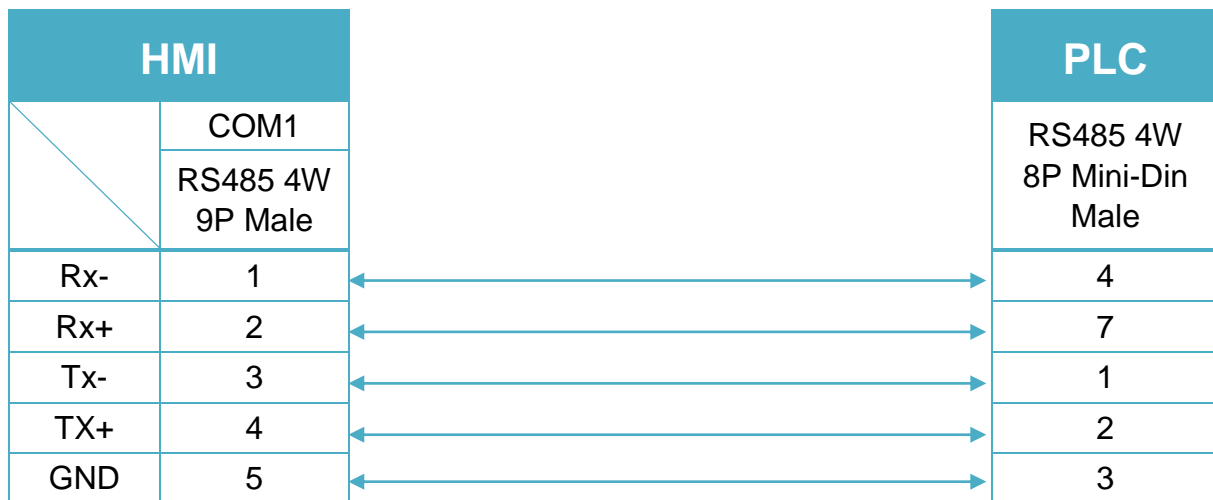


Diagram 2

cMT Series *cMT-SVR*

mTV *mTV*

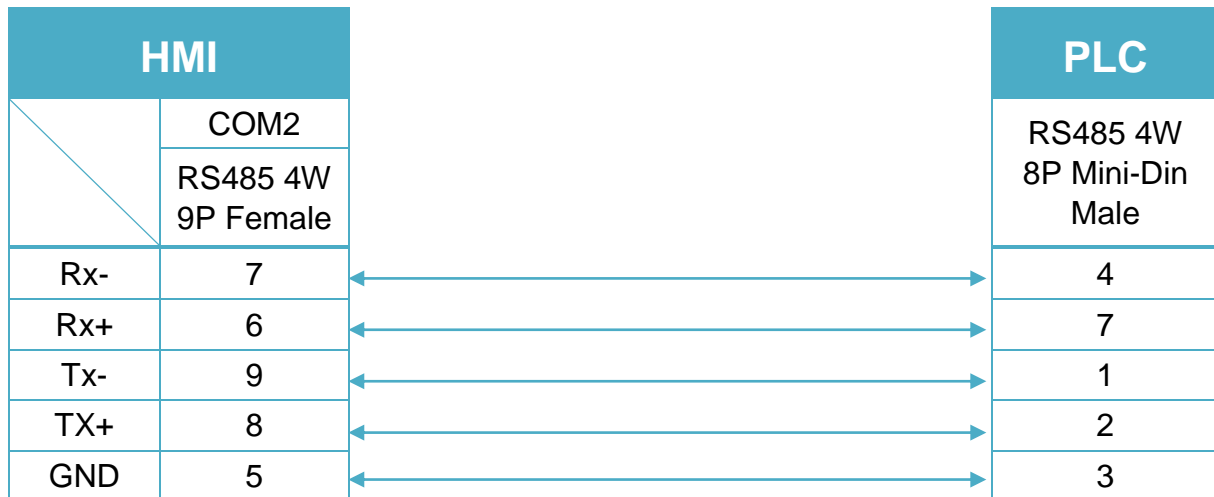


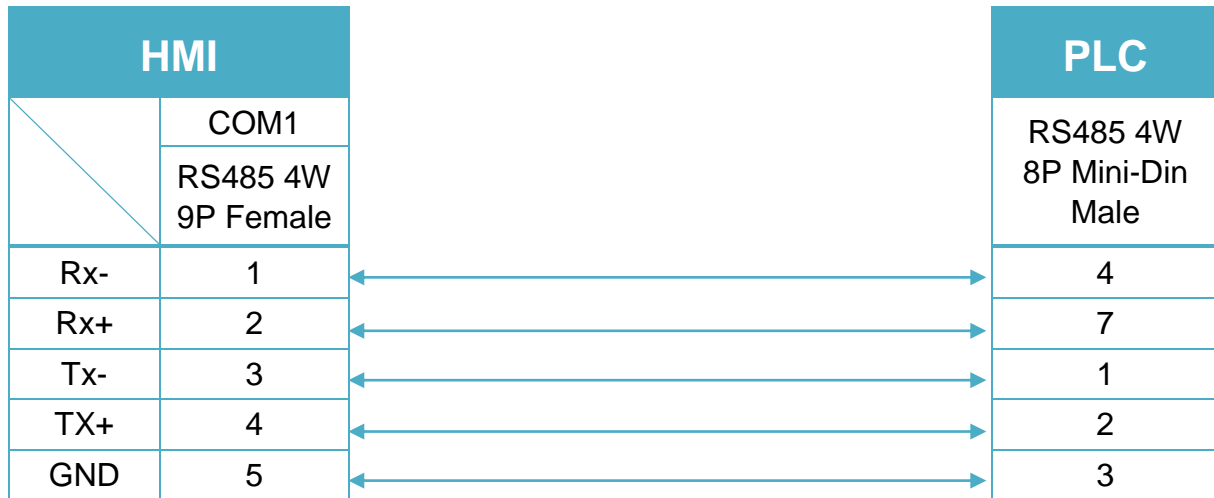
Diagram 3

MT-iE *MT8071iE / MT6071iE / MT8072iE / MT6072iE / MT8073iE /
MT8101iE / MT8102iE / MT8103iE*

MT-XE *MT8090XE / MT8092XE*

MT-iP *MT6071iP / MT8071iP / MT6103iP*



Diagram 4
MT-iE *MT8050iE*
MT-iP *MT6051iP*


Mitsubishi FX5U

Supported Series: Mitsubishi FX5U/FX5UC

Website: <http://www.mitsubishi-automation.com>

HMI Setting:

Parameters	Recommended	Options	Notes
PLC type	Mitsubishi FX5U		
PLC I/F	RS485 4w		
Baud rate	19200	9600 ~ 115200	
Data bits	8	7 , 8	
Parity	None	None/Odd/Even	
Stop bits	1	1 , 2	
PLC sta. no.	0	0 ~ 15	
Message pattern	1	1,4,5	Message Pattern *Note1
Network number	0	0 ~ 999	

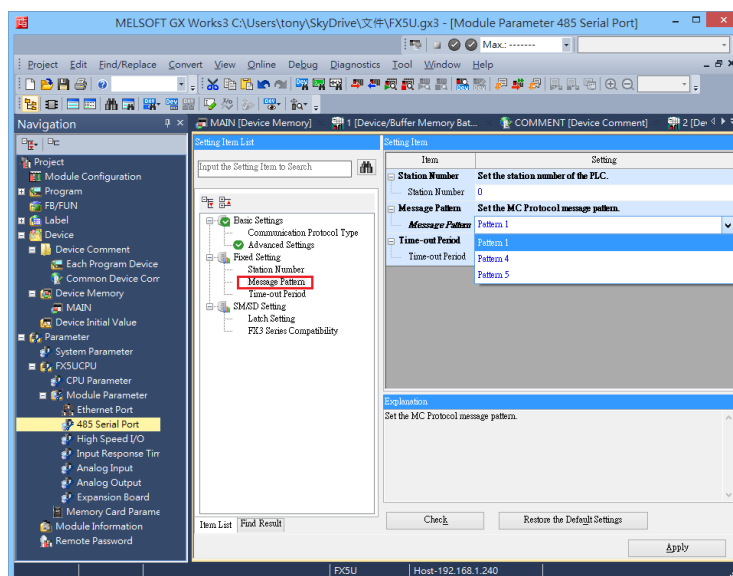
*Note1:

Pattern1 = ASCII Mode

Pattern4 = ASCII Mode (CR,LF)

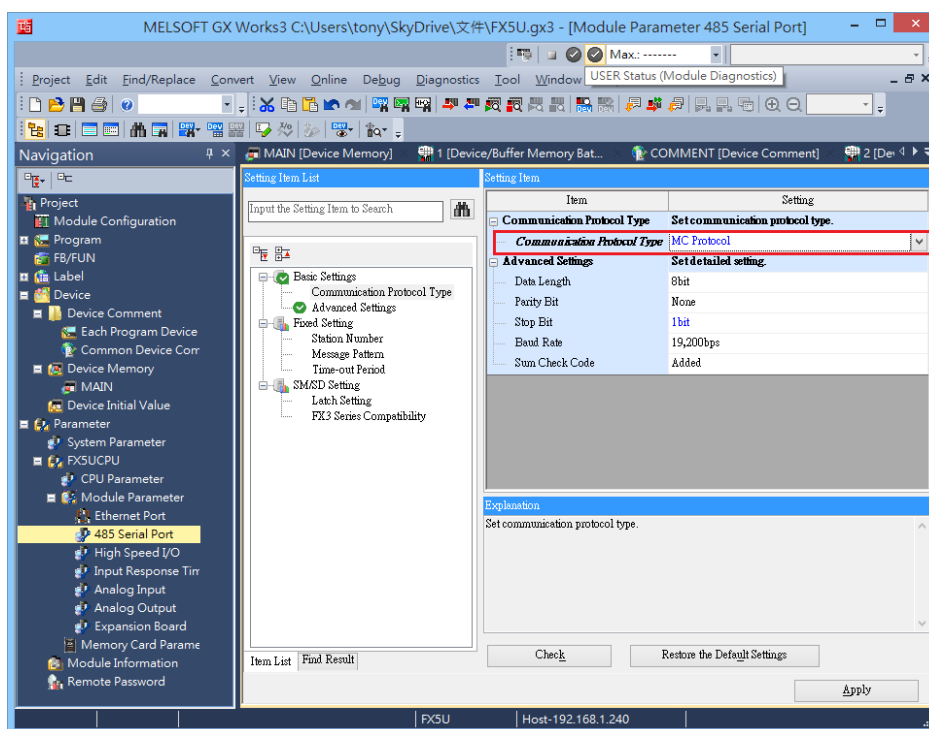
Pattern5 = Binary Mode

Online simulator	YES	Extend address mode	NO
-------------------------	------------	----------------------------	-----------



PLC Setting:

Communication Protocol	MC Protocol
Sum Check Code	Added



Device Address:

Bit/Word	Device	Format	Range	Memo
B	LCS	DDDD	0 ~ 1023	Long counter Contact
B	LCC	DDDD	0 ~ 1023	Long counter Coil
B	SM	DDDD	0 ~ 9999	Special Relay
B	X	OOOO	0 ~ 1777	Input Relay
B	Y	OOOO	0 ~ 1777	Output Relay
B	M	DDDDD	0 ~ 32767	Internal Relay
B	L	DDDDD	0 ~ 32767	Latch Relay
B	F	DDDDD	0 ~ 32767	Annunciator
B	B	HHHH	0 ~ 7FFF	Link Relay
B	TS	DDDD	0 ~ 1023	Timer Contact
B	TC	DDDD	0 ~ 1023	Timer Coil
B	SS	DDDD	0 ~ 1023	Retentive Timer Contact
B	SC	DDDD	0 ~ 1023	Retentive Timer Coil
B	CS	DDDD	0 ~ 1023	Counter Contact

Bit/Word	Device	Format	Range	Memo
B	CC	DDDD	0 ~ 1023	Counter Coil
B	SB	HHHH	0 ~ 7FFF	Special Link Relay
B	S	DDDD	0 ~ 4095	Step relay
B	D_Bit	DDDDh	0 ~ 7999F	Data Register bit
B	SD_bit	DDDDDh	0 ~ 11999F	Special register Bit
B	R_bit	DDDDDh	0 ~ 32767F	File Register Bit
B	SW_bit	HHHHh	0 ~ 7FFFF	Special Link Register Bit
B	W_bit	HHHHh	0 ~ 7FFFF	Link Register Bit
DW	LCN	DDDD	0 ~ 1023	Long counter Current Value
DW	LZ	D	0 ~ 1	Long Index Register
W	SD	DDDDD	0 ~ 11999	Special register
W	D	DDDD	0 ~ 7999	Data Register
W	R	DDDDD	0 ~ 32767	File Register
W	W	HHHH	0 ~ 7FFF	Link Register
W	TN	DDDD	0 ~ 1023	Timer Current value
W	SN	DDDD	0 ~ 1023	Retentive Timer Current value
W	CN	DDDD	0 ~ 1023	Counter Current value
W	SW	HHHH	0 ~ 7FFF	Special Link Register
W	Z	DD	0 ~ 19	Index Register

Wiring Diagram:

Diagram 1

cMT Series	<i>cMT3151</i>
eMT Series	<i>eMT3070 / eMT3105 / eMT3120 / eMT3150</i>
MT-iE	<i>MT8070iE / MT6070iE / MT8100iE / MT8121iE / MT8150iE</i>
MT-XE	<i>MT8121XE / MT8150XE</i>

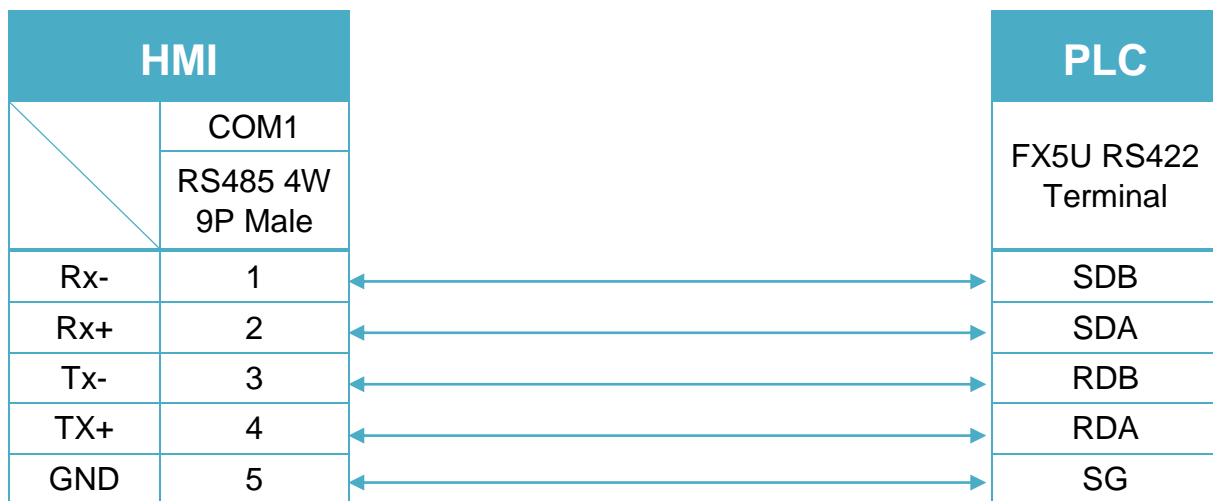


Diagram 2

cMT Series	<i>cMT-SVR</i>
mTV	<i>mTV</i>

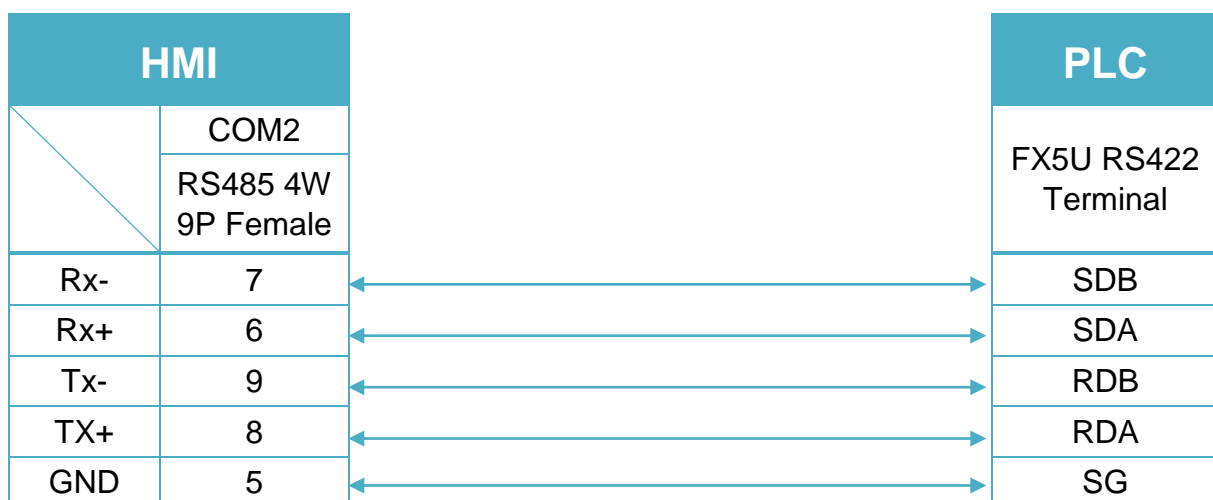


Diagram 3

MT-iE	<i>MT8071iE / MT6071iE / MT8072iE / MT6072iE / MT8073iE / MT8101iE / MT8102iE / MT8103iE</i>
MT-XE	<i>MT8090XE / MT8092XE</i>
MT-iP	<i>MT6071iP / MT8071iP / MT6103iP</i>

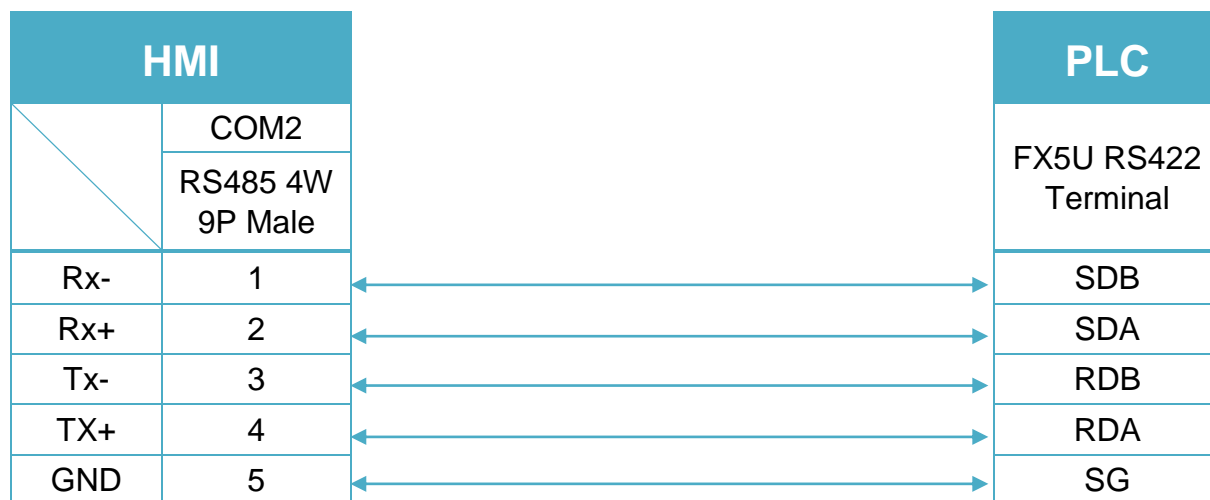
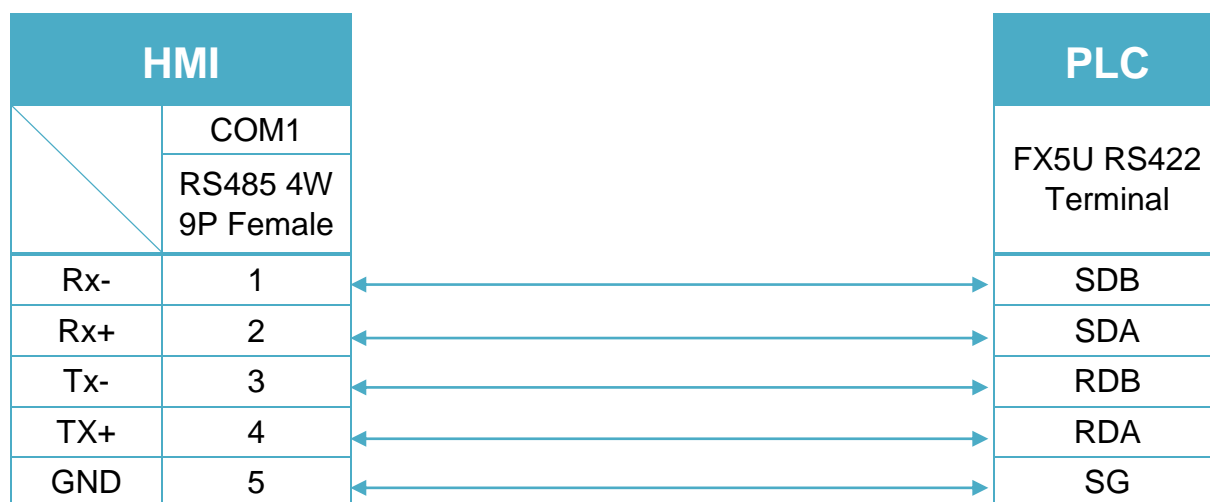


Diagram 4

MT-iE	<i>MT8050iE</i>
MT-iP	<i>MT6051iP</i>



Mitsubishi FX5U - ASCII Mode (Ethernet)

Supported Series: Mitsubishi FX5U ethernet module

Website: <http://www.mitsubishi-automation.com>

HMI Setting:

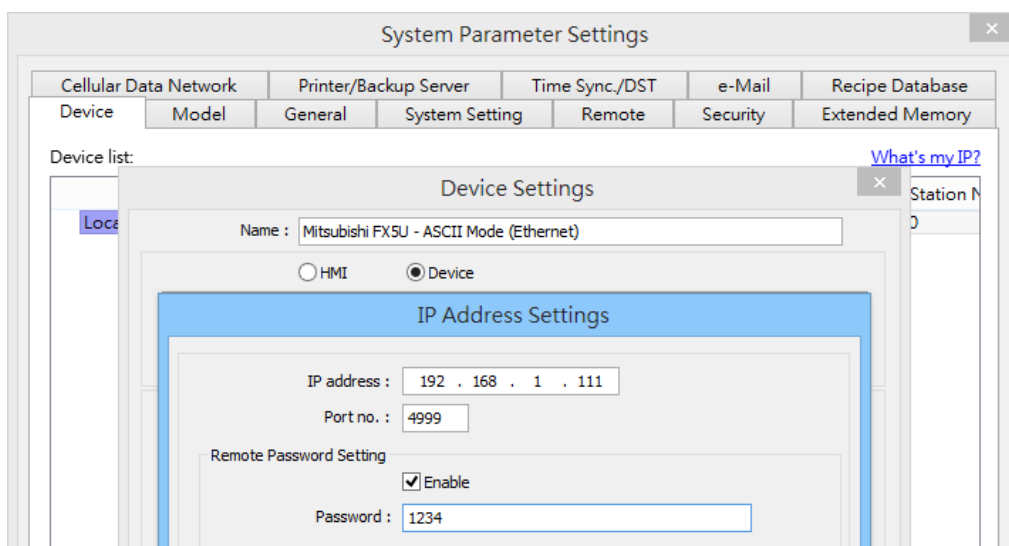
Parameters	Recommended	Options	Notes
PLC type	Mitsubishi FX5U - ASCII Mode (Ethernet)		
PLC I/F	Ethernet		
Port no.	Set identically to the PLC		Advised to set port no. to 4999
PLC sta. no.	255		
Network number	0	0~999	

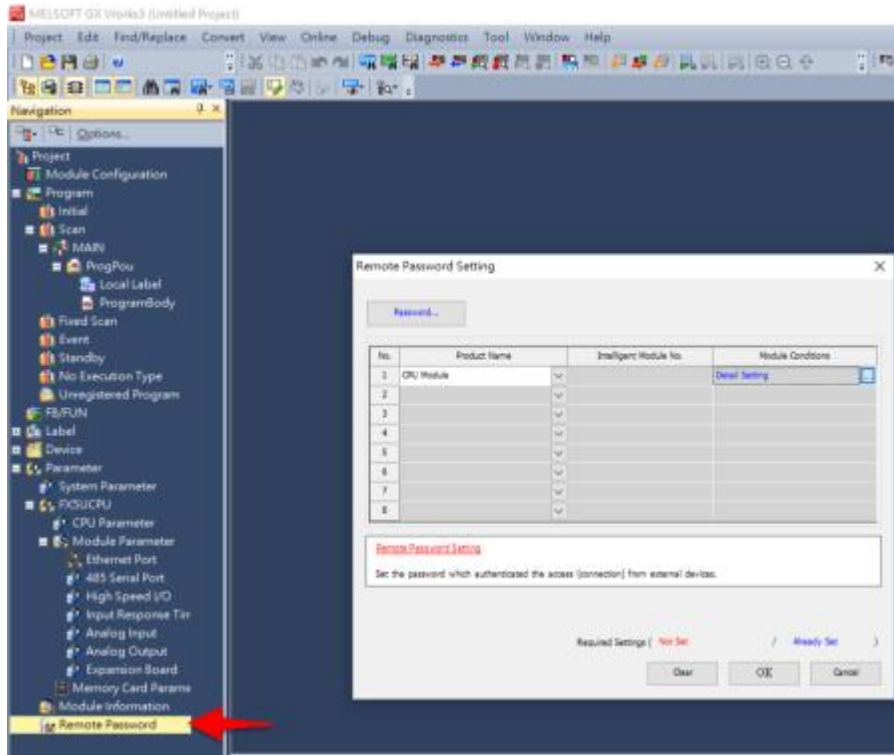
Online simulator YES

[Remote Password Setting]

Set a remote password and a target connection in the engineering tool, and write the data to the CPU module.

Navigation Window => [Parameter] => [Remote Password] => [Remote Password Setting] Screen





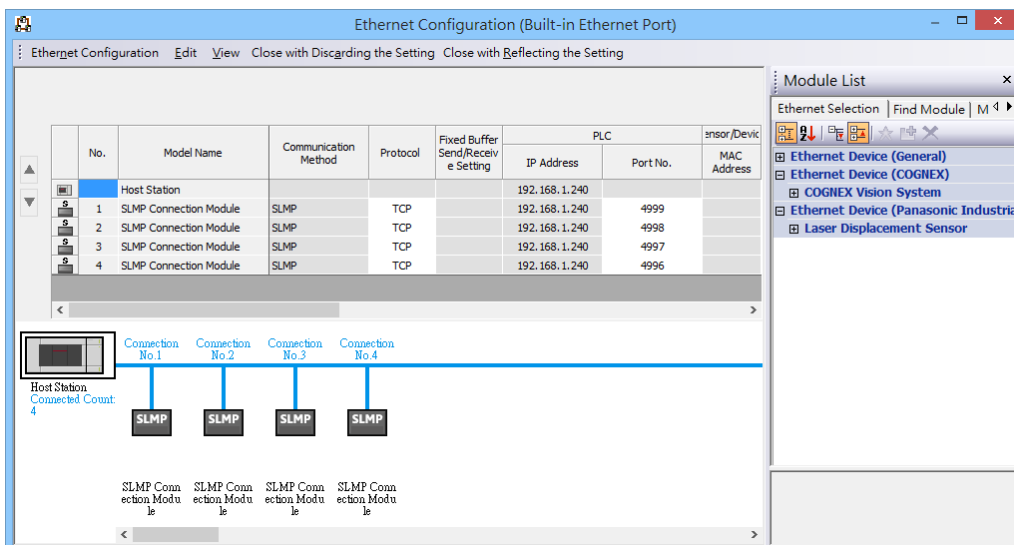
PLC Setting:

Communication Data Code ASCII

[Ethernet Configuration]

To connect PLC with multiple HMIs, Port No. must be set.

In GX WORK 3, the setting steps are: Project -> Parameter -> FX5UCPU -> Module Parameter -> Ethernet Port -> Setting Item -> External Device Configuration -> Detailed Setting



Device Address:

Bit/Word	Device type	Format	Range	Memo
B	SM	DDDD	0 ~ 9999	Special Relay
B	X	OOOO	0 ~ 1777	Input Relay
B	Y	OOOO	0 ~ 1777	Output Relay
B	M	DDDDD	0 ~ 32767	Internal Relay
B	L	DDDDD	0 ~ 32767	Latch Relay
B	F	DDDDD	0 ~ 32767	Annunciator
B	B	HHHH	0 ~ 7FFF	Link Relay
B	TS	DDDD	0 ~ 1023	Timer Contact
B	TC	DDDD	0 ~ 1023	Timer Coil
B	SS	DDDD	0 ~ 1023	Retentive Timer Contact
B	SC	DDDD	0 ~ 1023	Retentive Timer Coil
B	CS	DDDD	0 ~ 1023	Counter Contact
B	CC	DDDD	0 ~ 1023	Counter Coil
B	SB	HHHH	0 ~ 7FFF	Special Link Relay
B	S	DDDD	0 ~ 4095	Step relay
B	D_Bit	DDDDh	0 ~ 7999F	Data Register bit
B	SD_bit	DDDDDh	0 ~ 11999F	Special register Bit
B	R_bit	DDDDDh	0 ~ 32767F	File Register Bit
B	SW_bit	HHHHh	0 ~ 7FFFF	Special Link Register Bit
B	W_bit	HHHHh	0 ~ 7FFFF	Link Register Bit
DW	LZ	D	0 ~ 1	Long Index Register
W	SD	DDDDD	0 ~ 11999	Special register
W	D	DDDD	0 ~ 7999	Data Register
W	R	DDDDD	0 ~ 32767	File Register
W	W	HHHH	0 ~ 7FFF	Link Register
W	TN	DDDD	0 ~ 1023	Timer Current value
W	SN	DDDD	0 ~ 1023	Retentive Timer Current value
W	CN	DDDD	0 ~ 1023	Counter Current value
W	SW	HHHH	0 ~ 7FFF	Special Link Register
W	Z	DD	0 ~ 19	Index Register

Wiring Diagram:

Ethernet cable:



Mitsubishi FX5U - Binary Mode (Ethernet)

Supported Series: Mitsubishi FX5U ethernet module

Website: <http://www.mitsubishi-automation.com>

HMI Setting:

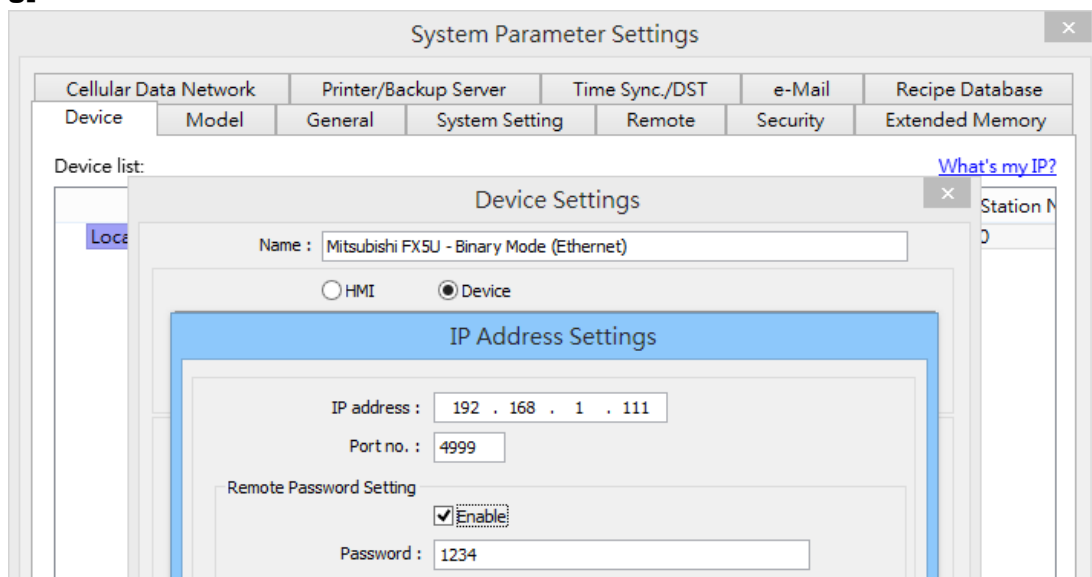
Parameters	Recommended	Options	Notes
PLC type	Mitsubishi FX5U - Binary Mode (Ethernet)		
PLC I/F	Ethernet		
Port no.	Set identically to the PLC setting		Advised to set port no. to 4999
PLC sta. no.	255		
Network number	0	0~999	

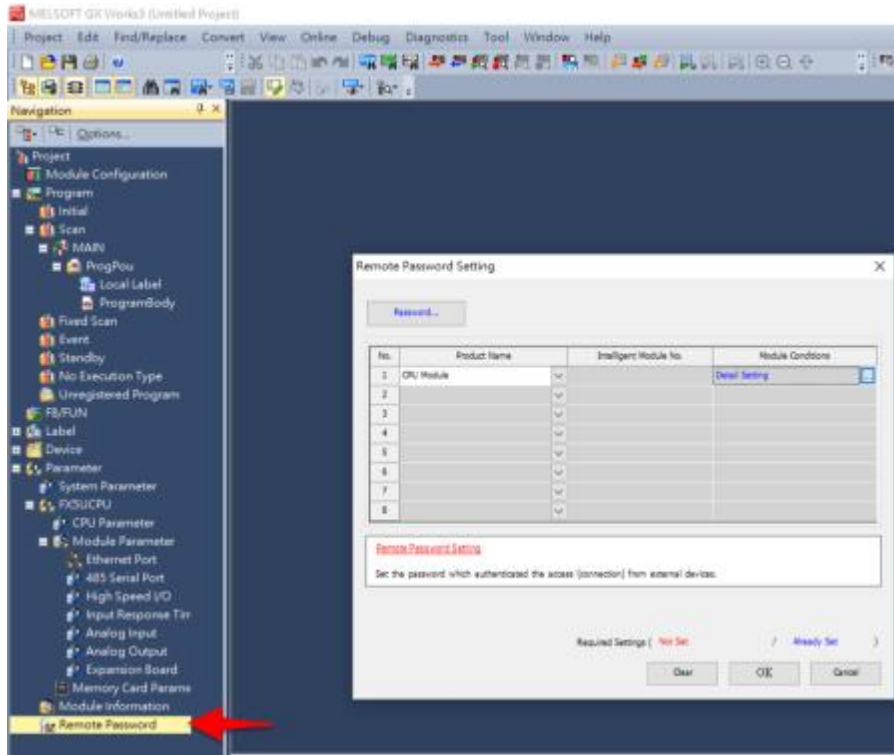
Online simulator YES

[Remote Password Setting]

Set a remote password and a target connection in the engineering tool, and write the data to the CPU module.

Navigation Window => [Parameter] => [Remote Password] => [Remote Password Setting] Screen





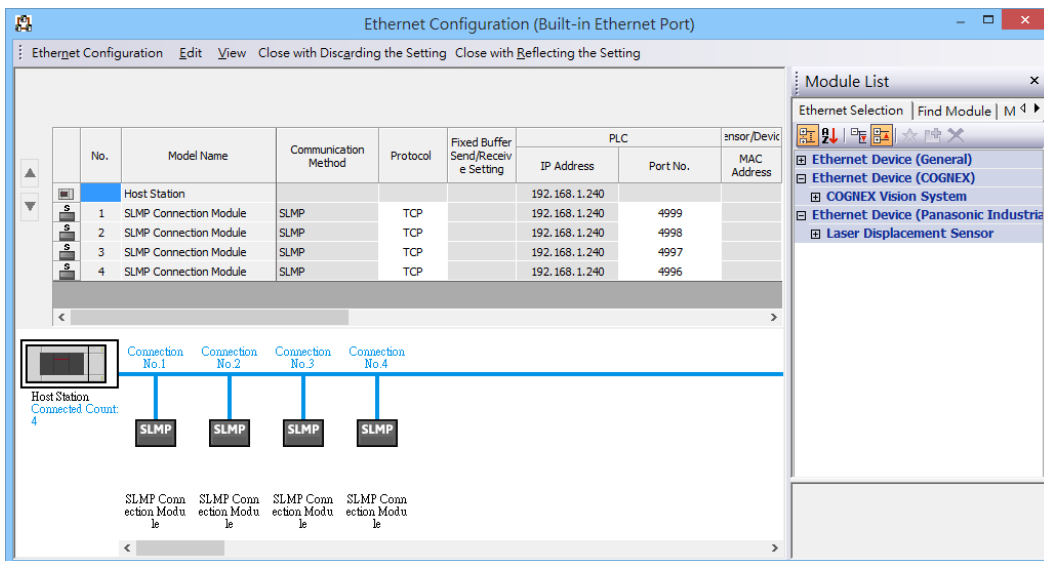
PLC Setting:

Communication Data Code Binary

[Ethernet Configuration]

To connect PLC with multiple HMIs, Port No. must be set.

In GX WORK 3, the setting steps are: Project -> Parameter -> FX5UCPU -> Module Parameter -> Ethernet Port -> Setting Item -> External Device Configuration -> Detailed Setting



Device Address:

Bit/Word	Device type	Format	Range	Memo
B	LCS	DDDD	0 ~ 1023	Long counter Contact
B	LCC	DDDD	0 ~ 1023	Long counter Coil
B	SM	DDDD	0 ~ 9999	Special Relay
B	X	OOOO	0 ~ 1777	Input Relay
B	Y	OOOO	0 ~ 1777	Output Relay
B	M	DDDDD	0 ~ 32767	Internal Relay
B	L	DDDDD	0 ~ 32767	Latch Relay
B	F	DDDDD	0 ~ 32767	Annunciator
B	B	HHHH	0 ~ 7FFF	Link Relay
B	TS	DDDD	0 ~ 1023	Timer Contact
B	TC	DDDD	0 ~ 1023	Timer Coil
B	SS	DDDD	0 ~ 1023	Retentive Timer Contact
B	SC	DDDD	0 ~ 1023	Retentive Timer Coil
B	CS	DDDD	0 ~ 1023	Counter Contact
B	CC	DDDD	0 ~ 1023	Counter Coil
B	SB	HHHH	0 ~ 7FFF	Special Link Relay
B	S	DDDD	0 ~ 4095	Step relay
B	D_Bit	DDDDh	0 ~ 7999F	Data Register bit
B	SD_bit	DDDDDh	0 ~ 11999F	Special register Bit
B	R_bit	DDDDDh	0 ~ 32767F	File Register Bit
B	SW_bit	HHHHh	0 ~ 7FFFF	Special Link Register Bit
B	W_bit	HHHHh	0 ~ 7FFFF	Link Register Bit
DW	LCN	DDDD	0 ~ 1023	Long counter Current Value
DW	LZ	D	0 ~ 1	Long Index Register
W	SD	DDDDD	0 ~ 11999	Special register
W	D	DDDD	0 ~ 7999	Data Register
W	R	DDDDD	0 ~ 32767	File Register
W	W	HHHH	0 ~ 7FFF	Link Register
W	TN	DDDD	0 ~ 1023	Timer Current value
W	SN	DDDD	0 ~ 1023	Retentive Timer Current value
W	CN	DDDD	0 ~ 1023	Counter Current value
W	SW	HHHH	0 ~ 7FFF	Special Link Register
W	Z	DD	0 ~ 19	Index Register

Wiring Diagram:

Ethernet cable:



Mitsubishi L6ADP

Supported Series: Mitsubishi L6ADP CPU RS232 Series Port

Website: <http://www.mitsubishi-automation.com>

HMI Setting:

Parameters	Recommended	Options	Notes
PLC type	Mitsubishi L6ADP		
PLC I/F	RS232		
Baud rate	115200		
Data bits	8		
Parity	Odd		
Stop bits	1		
PLC sta. no.	1		

Online simulator	YES	Extend address mode	NO
Pass-Through	YES		

*Communications between HMI and PLC in pass-through mode are not supported.

*Set LW-9903 to 2 to enhance the speed of download/upload PLC program in pass-through mode

Device Address:

Bit/Word	Device	Format	Range	Memo
B	SM	DDDD	0 ~ 2047	Special Int. Relays
B	X	HHHH	0 ~ 1FFF	Input Relay
B	Y	HHHH	0 ~ 1FFF	Output Relay
B	M	DDDD	0 ~ 8191	Internal Relay
B	L	DDDD	0 ~ 8191	Latch Relay
B	F	DDDD	0 ~ 2047	Annunciator
B	V	DDDD	0 ~ 2047	Edge Relay
B	B	HHHH	0 ~ 1FFF	Link Relay
B	SB	HHH	0 ~ 7FF	Special Link Relay
B	D_Bit	DDDDDDh	0 ~ 143359F	Data Register bit
W	SD	DDDD	0 ~ 2047	Special register
W	D	DDDDDD	0 ~ 143359	Data Register
W	W	HHHH	0 ~ 1FFF	Link Register

Bit/Word	Device	Format	Range	Memo
W	SW	HHH	0 ~ 7FF	Special Link Register
W	Z	DD	0 ~ 19	Index Register
W	C	DDDD	0 ~ 2047	Counter
W	T	DDDD	0 ~ 1023	Timer

Wiring Diagram:

The following is the view from the soldering point of a connector.



Diagram 1

cMT Series	<i>cMT3151</i>
eMT Series	<i>eMT3070 / eMT3105 / eMT3120 / eMT3150</i>
MT-iE	<i>MT8073iE / MT8102iE</i>
MT-XE	<i>MT8092XE</i>
MT-iP	<i>MT6103iP</i>

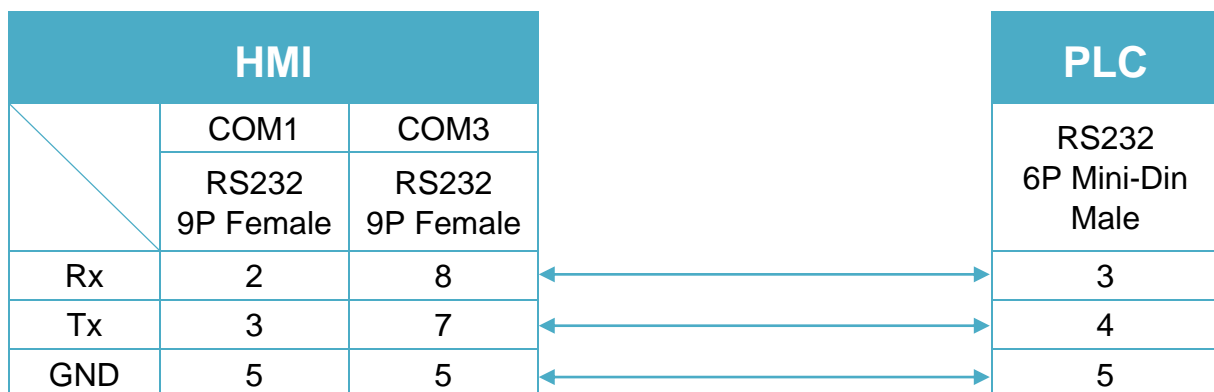


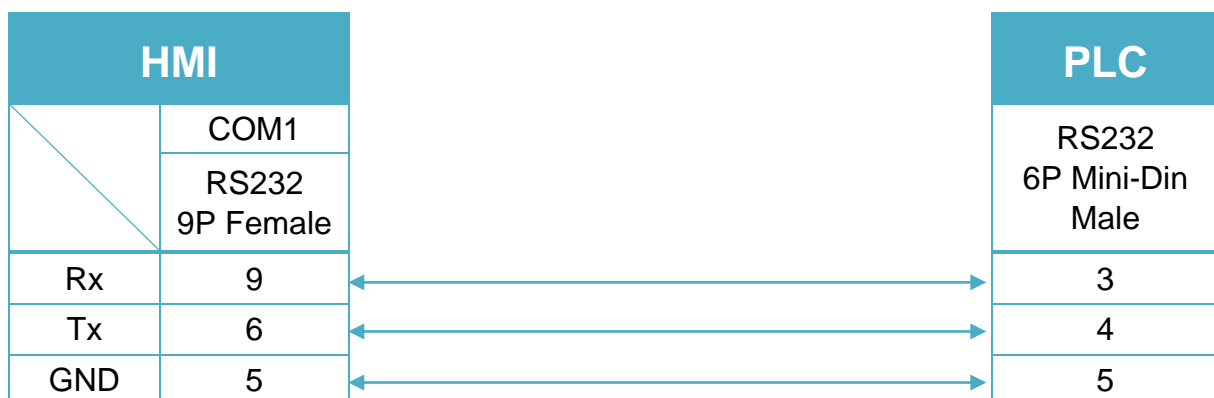
Diagram 2

cMT Series	cMT-SVR
mTV	mTV
MT-iE	MT8070iE / MT6070iE / MT8100iE / MT8121iE / MT8150iE / MT8071iE / MT6071iE / MT8072iE / MT6072iE / MT8073iE / MT8101iE / MT8102iE / MT8103iE
MT-XE	MT8121XE / MT8150XE / MT8090XE /



Diagram 3

MT-iE	MT8050iE
MT-iP	MT6051iP / MT6071iP / MT8071iP



Mitsubishi MELSEC-Q/L - ASCII Mode (Ethernet)

Supported Series: Mitsubishi Q series (Q03UDE, Q04UDEH, Q06UDEH, Q10UDEH, Q13UDEH, Q20UDEH, Q26UDEH, Q002UD), Mitsubishi L series(L02, L26-BT), MELSEC-Q/L protocol application to CPU of Ethernet interface or Ethernet module.

Website: <http://www.mitsubishi-automation.com>

HMI Setting:

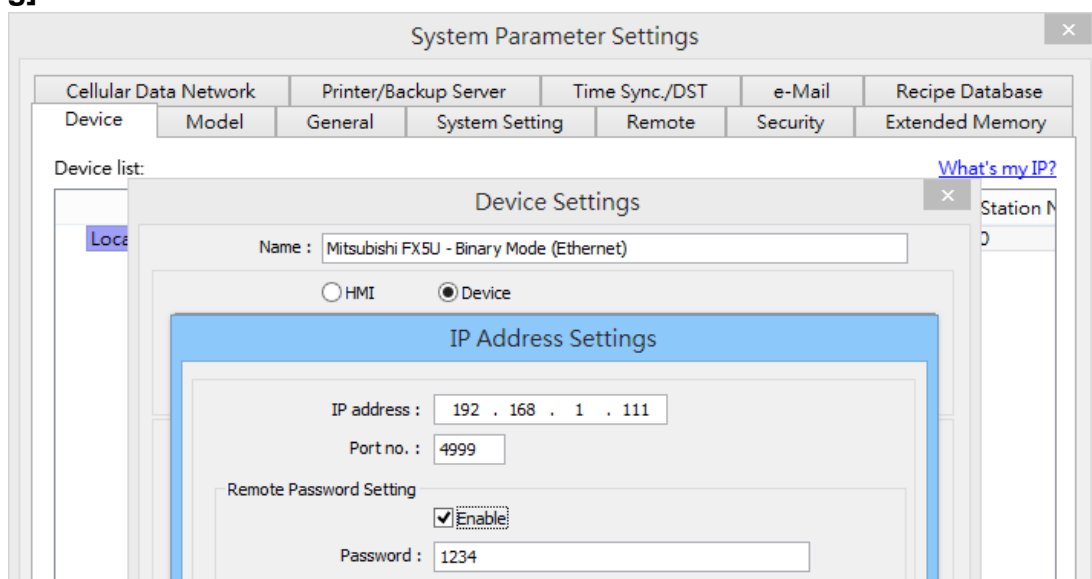
Parameters	Recommended	Options	Notes
PLC type	Mitsubishi MELSEC-Q/L - ASCII Mode (Ethernet)		
PLC I/F	Ethernet		
Port no.	4999	1025 to 4999 or 5010 to 65534	
Network number	0	0~255	
PLC sta. no.	255	255	
Protocol	TCP	TCP / UDP	MC Protocol

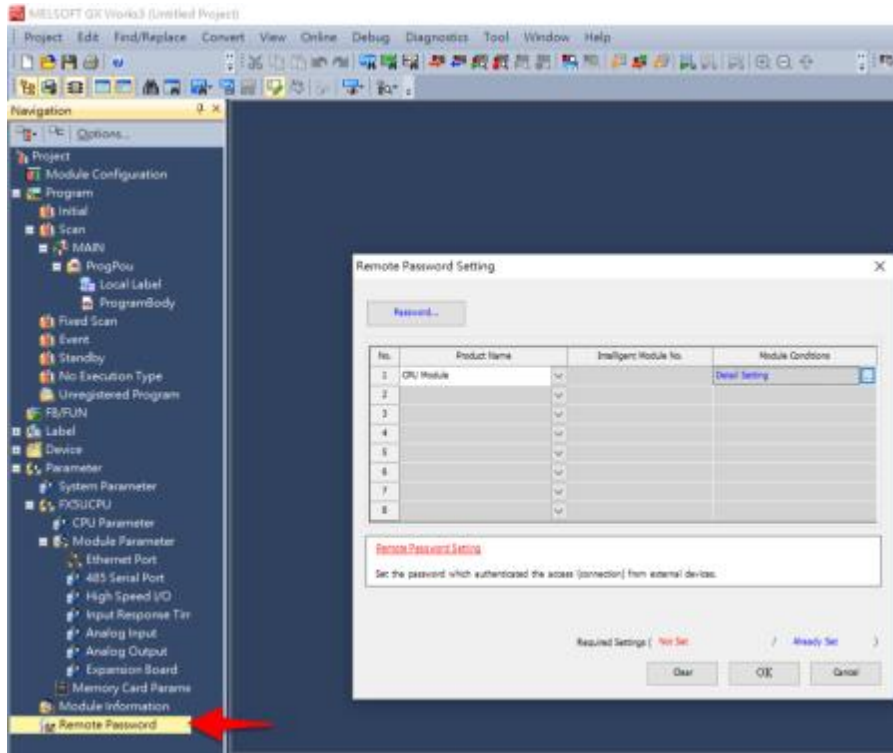
Online simulator	YES
-------------------------	-----

[Remote Password Setting]

Set a remote password and a target connection in the engineering tool, and write the data to the CPU module.

Navigation Window => **[Parameter]** => **[Remote Password]** => **[Remote Password Setting]** Screen

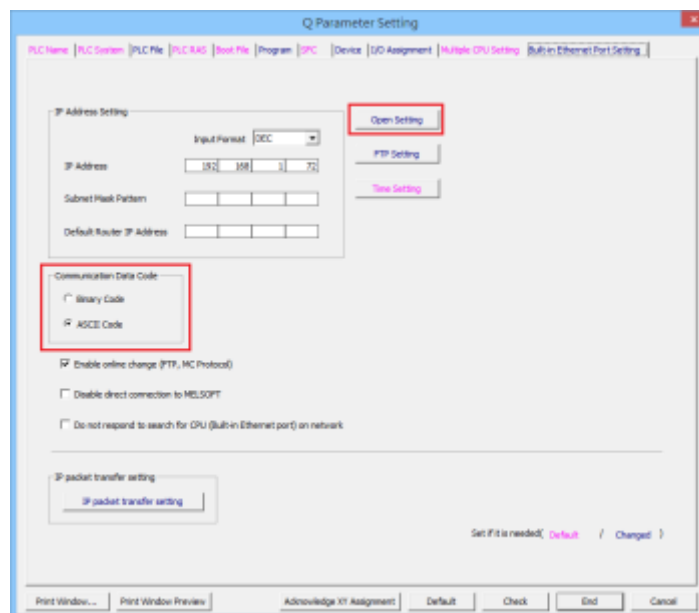




PLC Setting:

MITSUBISHI Q/L series Ethernet module setting:

Note: If using QJ71E71 module, please refer to MITSUBISHI QJ71E71 connection guide.



1. **Protocol:** TCP or UDP
2. **Open System:** MC Protocol
3. **Host Station:** 1025 to 4999 or 5010 to 65534

Built-in Ethernet Port Open Setting

IP Address/Port No. Input Format DEC

	Protocol	Open System	TCP Connection	Host Station	Destination IP Address	Destination Port No.	Start Device to Store Predefined Protocol
1	TCP	MC Protocol		4999			
2	TCP	MC Protocol		4998			
3	TCP	MC Protocol		4997			
4	TCP	MC Protocol		4996			
5	UDP	MC Protocol		4995			
6	UDP	MC Protocol		4994			
7	UDP	MC Protocol		4993			
8	UDP	MC Protocol		4992			
9	TCP	MELSOFT Connection					
10	TCP	MELSOFT Connection					
11	TCP	MELSOFT Connection					
12	TCP	MELSOFT Connection					
13	TCP	MELSOFT Connection					
14	TCP	MELSOFT Connection					
15	TCP	MELSOFT Connection					
16	TCP	MELSOFT Connection					

(*) IP Address and Port No. will be displayed by the selected format.
Please enter the value according to the selected number.

End
Cancel

Device Address:

Bit/Word	Device type	Format	Range	Memo
B	SM	DDDD	0 ~ 2047	Special Relay
B	X	HHHH	0 ~ 1fff	Input Relay
B	Y	HHHH	0 ~ 1fff	Output Relay
B	M	DDDDD	0 ~ 61439	Internal Relay
B	L	DDDDD	0 ~ 32767	Latch Relay
B	F	DDDDD	0 ~ 32767	Annunciator
B	V	DDDDD	0 ~ 32767	Edge Relay
B	B	HHHH	0 ~ efff	Link Relay
B	TS	DDDDD	0 ~ 25471	Timer Contact
B	TC	DDDDD	0 ~ 25471	Timer Coil
B	SS	DDDDD	0 ~ 25471	Retentive Timer Contact
B	SC	DDDDD	0 ~ 25471	Retentive Timer Coil
B	CS	DDDDD	0 ~ 25471	Counter Contact
B	CC	DDDDD	0 ~ 25471	Counter Coil
B	SB	HHHH	0 ~ 7fff	Special Link Relay
B	S	DDDD	0 ~ 8191	Step relay

Bit/Word	Device type	Format	Range	Memo
B	DX	HHHH	0 ~ 1fff	Direct Input
B	DY	HHHH	0 ~ 1fff	Direct Output
B	D_bit	DDDDDDh	0 ~ 999999f	Data Register bit
B	SD_bit	DDDDh	0 ~ 2047f	Special register Bit
B	ZR_bit	DDDDDDh	0 ~ 999999f	File Register Bit
B	R_bit	DDDDh	0 ~ 32767f	File Register Bit
B	SW_bit	HHHh	0 ~ 7fff	Special Link Register Bit
B	W_bit	HHHHHHh	0 ~ 3fd7fff	Link Register Bit
W	SD	DDDD	0 ~ 2047	Special register
W	D	DDDDDD	0 ~ 999999	Data Register
W	W	HHHHHH	0 ~ 3fd7ff	Link Register
W	TN	DDDDD	0 ~ 25471	Timer Current value
W	SN	DDDDD	0 ~ 25471	Retentive Timer Current value
W	CN	DDDDD	0 ~ 25471	Counter Current value
W	SW	HHH	0 ~ 7ff	Special Link Register
W	Z	DD	0 ~ 20	Index Register
W	R	DDDDD	0 ~ 32767	File Register
W	ZR	DDDDDD	0 ~ 999999	File Register

Note: Each model of CPU is different, it is recommended to refer to MITSUBISHI MELSEC-Q Manual Device List.

Wiring Diagram:

Ethernet cable:



Mitsubishi MELSEC-Q/L - Binary Mode (Ethernet)

Supported Series: Mitsubishi Q series (Q03UDE, Q04UDEH, Q06UDEH, Q10UDEH, Q13UDEH, Q20UDEH, Q26UDEH, Q02UD), Mitsubishi L series(L02, L26-BT), MELSEC-Q/L protocol application to CPU of Ethernet interface or Ethernet module.

Website: <http://www.mitsubishi-automation.com>

HMI Setting:

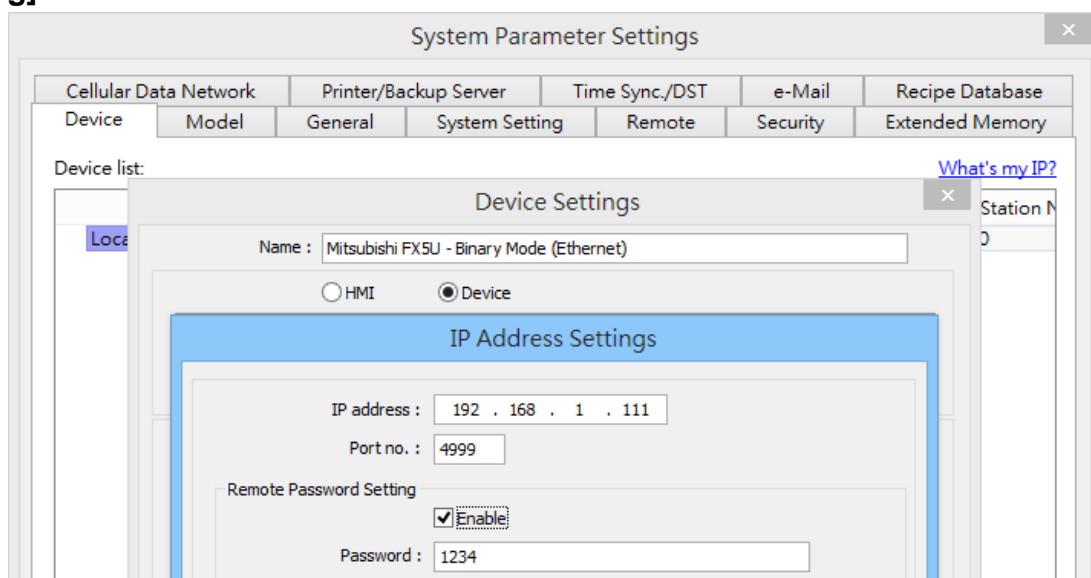
Parameters	Recommended	Options	Notes
PLC type	Mitsubishi MELSEC-Q/L - Binary Mode (Ethernet)		
PLC I/F	Ethernet		
Port no.	4999	1025 to 4999 or 5010 to 65534	
Network number	0	0~255	
PLC sta. no.	255	255	
Protocol	TCP	TCP / UDP	MC Protocol

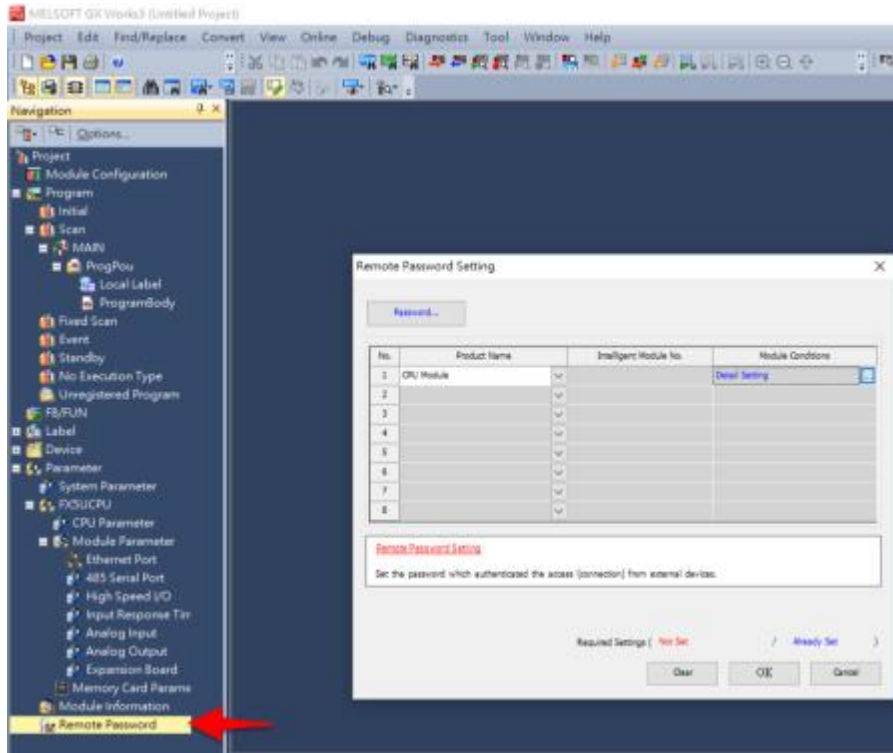
Online simulator	YES
-------------------------	-----

[Remote Password Setting]

Set a remote password and a target connection in the engineering tool, and write the data to the CPU module.

Navigation Window => **[Parameter]** => **[Remote Password]** => **[Remote Password Setting]** Screen

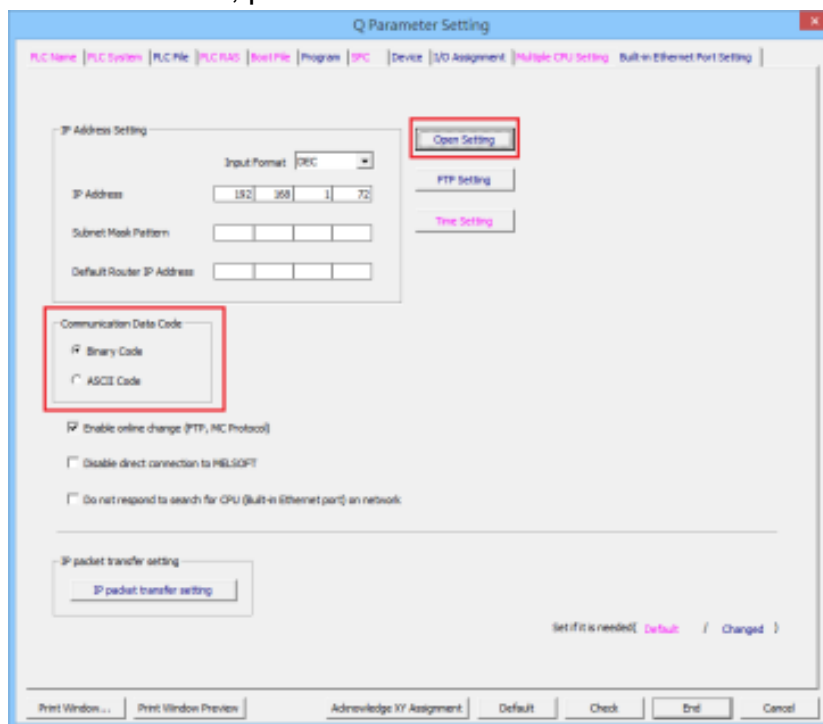




PLC Setting:

MITSUBISHI Q/L series Ethernet module setting:

Note: If using QJ71E71 module, please refer to MITSUBISHI QJ71E71 connection guide.



1. **Protocol:** TCP or UDP
2. **Open System:** MC Protocol
3. **Host Station:** 1025 to 4999 or 5010 to 65534

Built-in Ethernet Port Open Setting ✕

IP Address/Port No. Input Format DEC

	Protocol	Open System	TCP Connection	Host Station	Destination IP Address	Destination Port No.	Start Device to Store Predefined Protocol
1	TCP	MC Protocol		4999			
2	TCP	MC Protocol		4998			
3	TCP	MC Protocol		4997			
4	TCP	MC Protocol		4996			
5	UDP	MC Protocol		4995			
6	UDP	MC Protocol		4994			
7	UDP	MC Protocol		4993			
8	UDP	MC Protocol		4992			
9	TCP	MELSOFT Connection					
10	TCP	MELSOFT Connection					
11	TCP	MELSOFT Connection					
12	TCP	MELSOFT Connection					
13	TCP	MELSOFT Connection					
14	TCP	MELSOFT Connection					
15	TCP	MELSOFT Connection					
16	TCP	MELSOFT Connection					

(*) IP Address and Port No. will be displayed by the selected format.
Please enter the value according to the selected number.

End
Cancel

Device Address:

Bit/Word	Device type	Format	Range	Memo
B	SM	DDDD	0 ~ 2047	Special Relay
B	X	HHHH	0 ~ 1fff	Input Relay
B	Y	HHHH	0 ~ 1fff	Output Relay
B	M	DDDDD	0 ~ 61439	Internal Relay
B	L	DDDDD	0 ~ 32767	Latch Relay
B	F	DDDDD	0 ~ 32767	Annunciator
B	V	DDDDD	0 ~ 32767	Edge Relay
B	B	HHHH	0 ~ efff	Link Relay
B	TS	DDDDD	0 ~ 25471	Timer Contact
B	TC	DDDDD	0 ~ 25471	Timer Coil
B	SS	DDDDD	0 ~ 25471	Retentive Timer Contact
B	SC	DDDDD	0 ~ 25471	Retentive Timer Coil
B	CS	DDDDD	0 ~ 25471	Counter Contact
B	CC	DDDDD	0 ~ 25471	Counter Coil
B	SB	HHHH	0 ~ 7fff	Special Link Relay
B	S	DDDD	0 ~ 8191	Step relay

Bit/Word	Device type	Format	Range	Memo
B	DX	HHHH	0 ~ 1fff	Direct Input
B	DY	HHHH	0 ~ 1fff	Direct Output
B	D_Bit	DDDDDDDDh	0 ~ 4184063f	Data Register bit
B	SD_bit	DDDDh	0 ~ 2047f	Special register Bit
B	ZR_bit	HHHHHHh	0 ~ 3fd7fff	File Register Bit (Hex)
B	ZR_Dec_Bit	DDDDDDDDh	0 ~ 4184063f	File Register Bit (Dec)
B	R_bit	DDDDh	0 ~ 32767f	File Register Bit
B	SW_bit	HHHh	0 ~ 7fff	Special Link Register Bit
B	W_bit	HHHHHHh	0 ~ 3fd7fff	Link Register Bit
W	SD	DDDD	0 ~ 2047	Special register
W	D	DDDDDDDD	0 ~ 4184063	Data Register
W	W	HHHHHH	0 ~ 3fd7ff	Link Register
W	TN	DDDD	0 ~ 25471	Timer Current value
W	SN	DDDD	0 ~ 25471	Retentive Timer Current value
W	CN	DDDD	0 ~ 25471	Counter Current value
W	SW	HHH	0 ~ 7ff	Special Link Register
W	Z	DD	0 ~ 20	Index Register
W	R	DDDD	0 ~ 32767	File Register
W	ZR	HHHHHH	0 ~ 3fd7ff	File Register
W	ZR_Dec	DDDDDDDD	0 ~ 4184063	

Note: Each model of CPU is different, it is recommended to refer to MITSUBISHI MELSEC-Q Manual Device List.

Wiring Diagram:

Ethernet cable:



Mitsubishi MR J3/J4 A

Website: <http://www.mitsubishi-automation.com>

HMI Setting:

Parameters	Recommended	Options	Notes
PLC type	Mitsubishi MR J3/J4 A		
PLC I/F	RS485 4W	RS232/RS485	
Baud rate	9600	9600~115200	
Parity	Even		
Data bits	8		
Stop bits	1		
PLC sta. no.	0	0~31	

Device Address:

Bit/Word	Device	Format	Range	Memo
B	EIP	DD	0 ~ 31	External input pin status read *3
B	EOP	DD	0 ~ 31	External output pin status read *3
B	SP	D	0 ~ 6	
W	PA	DDDD	1 ~ 1032	Basic Setting *4
W	PB	DDDD	1 ~ 1064	Gain / Filter Setting *4
W	PC	DDDD	1 ~ 1080	Extension Setting *4
W	PD	DDDD	1 ~ 1048	Input / Output Setting *4
W	Status	DD	0 ~ 57	Amplifier Status *1
W	Alarm	D	0 ~ 6	Alarm
W	Alarm_T	D	0 ~ 6	Alarm Time (Hour) *2
W	Mode	D	1 ~ 4	Write Only, Mode Setting *2
W	Speed	D	0 ~ 1	Write Only, Set Current Speed *2
W	Acc	D	0 ~ 1	Write Only, Set Acceleration *2
W	Rotation	D	0 ~ 1	Write Only, Rotation Direction *2
W	End	D	0 ~ 1	Write Only, End *2
W	M_dist	D	0 ~ 1	Write Only, Moving Distance *2
W	Rot_P	D	0 ~ 1	Write Only, Rotation Position *2
W	P_start	D	0 ~ 1	Write Only, Start Positioning *2
W	Cur_Alarm	D	0 ~ 1	Current Alarm
W	PE	DDDD	1 ~ 1064	Extension Setting 2 *4

Bit/Word	Device	Format	Range	Memo
W	PF	DDDD	1 ~ 1048	Extension Setting 3 *4
W	PO	DDDD	1 ~ 1048	Extension Setting 2 *4
W	PS	DDDD	1 ~ 1048	Extension Setting 3 *4
W	PL	DDDD	1 ~ 1048	Extension Setting 2 *4
W	PT	DDDD	1 ~ 1048	Extension Setting 3 *4
DW	POS	DDDD	1 ~ 1255	
DW	SPD	DDDD	1 ~ 1255	
DW	ACT	DDDD	1 ~ 1255	
DW	DCT	DDDD	1 ~ 1255	
DW	DWL	DDDD	1 ~ 1255	
DW	AUX	DDDD	1 ~ 1255	
DW	MCD	DDDD	1 ~ 1255	

Note1 : Status information

Address	Item
0	Cumulative feedback pulses
1	Servo motor speed
2	Droop pulse
3	Cumulative cmd. Pulses
4	Command pulse frequency
5	Analog speed command voltage
6	Analog torque command voltage
7	Regenerative load ratio
8	Effective load ratio
9	Peak load ratio
10	Instantaneous torque
11	Within one-revolution position
12	ABS conter
13	Load inertia moment ratio
14	Bus voltage
15	Load-side cumulative feedback pulses
16	Load-side droop pulses
17	Load-side encoder information 1
18	Load-side encoder information 2
22	Motor thermistor temperature
23	Motor-side cumu.feedback pulses(before gear)
24	Electrical angle
30	Motor-side / load -side position deviation

31	Motor-side / load –side speed diviation
32	Encoder inside temperature
33	Setting time
34	Oscillation detection frequency
35	Number of tough drive operations
40	Unit power consumption
41	Unit total power consumption

Note2: represents the write-only registers. The usage of this kind of registers is to run Jog Mode and Positioning Mode.

Note3: represents the read-only registers.

Note4: The data in address 1~XX is written to RAM, and the data in address 1001~10XX is written to ROM.

EIP:

The ON/OFF statuses of the input pins are sent back.



Command of each bit is transmitted to the master station as hexadecimal data.

bit	CN1 connector pin	bit	CN1 connector pin	bit	CN1 connector pin	bit	CN1 connector pin
0	43	8	18	16		24	
1	44	9	45	17		25	
2	42	10		18		26	
3	15	11		19		27	
4	19	12		20		28	
5	41	13		21		29	
6	16	14		22		30	
7	17	15		23		31	

EOP:

The slave station sends back the ON/OFF statuses of the output pins.



Command of each bit is transmitted to the master station as hexadecimal data.

bit	CN1 connector pin	bit	CN1 connector pin	bit	CN1 connector pin	bit	CN1 connector pin
0	49	8		16		24	
1	24	9		17		25	
2	23	10		18		26	
3	25	11		19		27	
4	22	12		20		28	
5	48	13		21		29	
6	33	14		22		30	
7		15		23		31	

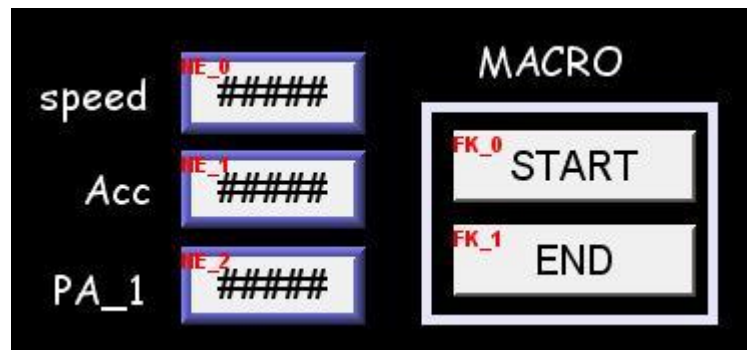
How to use EasyBuilder8000/Easy BuilderPro to run Jog and Positioning Mode

*Jog Mode

To run Jog Mode, please follow the steps listed sequentially:

- (1) Set Jog Mode
- (2) Set rotation speed
- (3) Set acceleration
- (4) Set forward / reverse rotation direction
- (5) End

The following shows how to run the steps above using Macro in EasyBuilder8000/Easy BuilderPro.



On the editing window of EasyBuilder8000/Easy BuilderPro, the write address of "speed" is set to Local HMI LW0 (the address can be user-defined), and set "Acc" (Acceleration) to LW1.

To run Jog Mode, the communication with the device must be continuous which only allows an interval less than 0.5 seconds, otherwise the motor will be locked. Therefore, in this example, only one register PA_1 is set to read device value.

Macro Demonstration:

a. Start Macro

```
macro_command main()
```

```
short speed
```

```
short acc
```

```
short mode
```

```
mode = 1 // This represents Jog Mode.
```

```
SetData(mode, "MITSUBISHI MR J3 A", Mode, 1, 1) // Set driver mode to Jog.
```

```
GetData(speed, "Local HMI", LW, 0, 1) // Save LW0 value to speed.
```

```
SetData(speed, "MITSUBISHI MR J3 A", Speed, 0, 1) // Set motor operating speed.
```

```

GetData(acc, "Local HMI", LW, 1, 1) //
SetData(acc, "MITSUBISHI MR J3 A", Acc, 0, 1) // Set motor acceleration.
    
```

short motion

```

motion = 0x0801 // Special code, see Note 1.
    
```

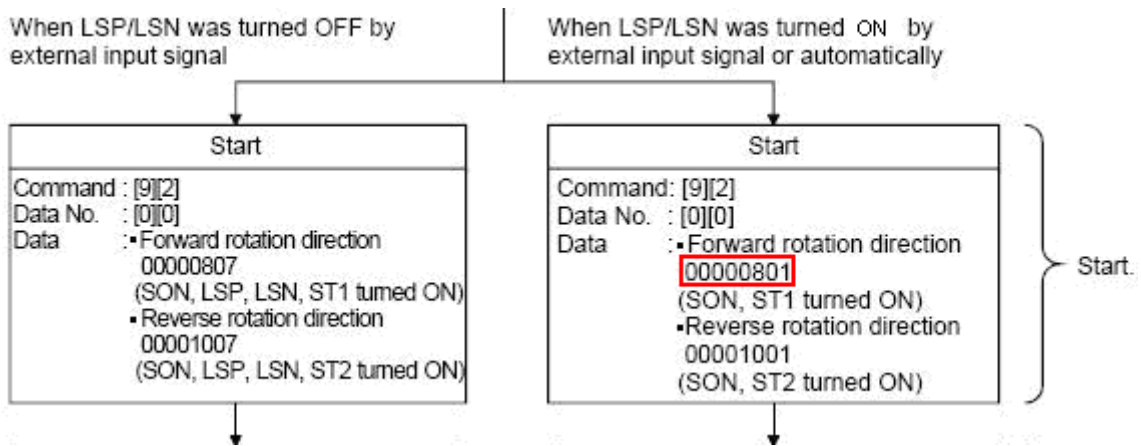
```

SetData(motion, "MITSUBISHI MR J3 A", Rotation, 0, 1) // Rotate.
    
```

```

end macro_command
    
```

Note 1. Original Factory Manual:



b. End Macro

```

macro_command main()
    
```

short stop

```

stop = 1 // See Note 2.
    
```

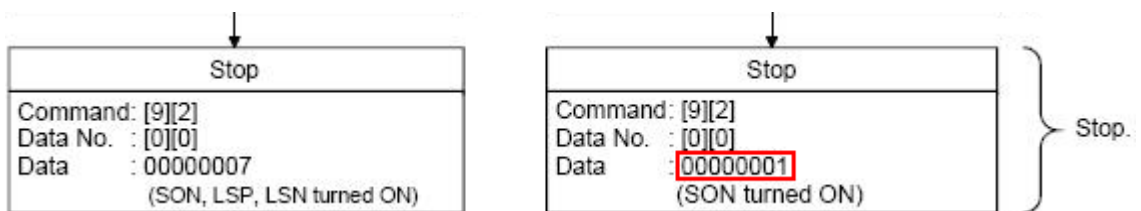
```

SetData(stop, "MITSUBISHI MR J3 A", End, 1, 1)
    
```

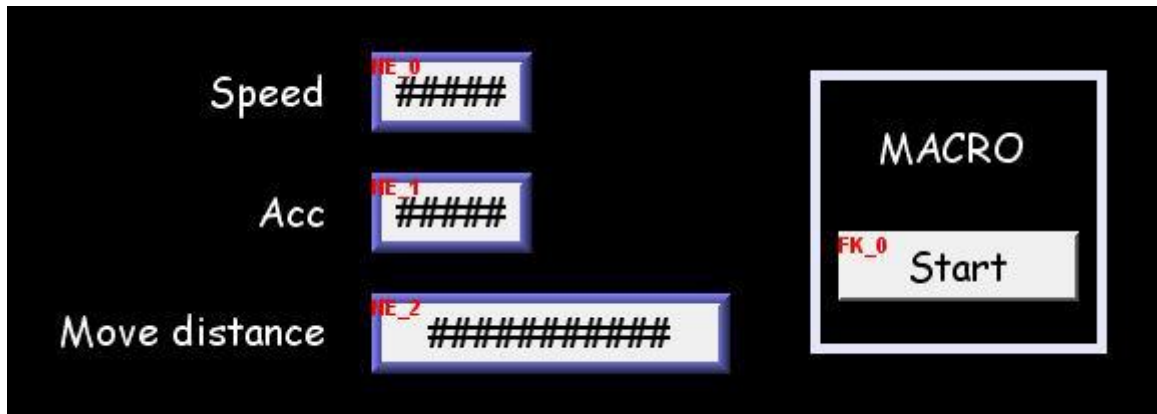
```

end macro_command
    
```

Note 2. Original Factory Manual:



*Positioning Mode



On the editing window of EasyBuilder8000/Easy BuilderPro, the write address of “Speed” is set to Local HMI LW2 (the address can be user-defined), and set “Acc” (Acceleration) to LW3, “Move distance” to LW4 (DW format).

Macro Demonstration:

```
macro_command main()
```

```
short mode
```

```
mode = 0x2 // Positioning Mode
```

```
SetData(mode, "MITSUBISHI MR J3 A", Mode, 1, 1)
```

```
short speed
```

```
GetData(speed, "Local HMI", LW, 2, 1)
```

```
SetData(speed, "MITSUBISHI MR J3 A", Speed, 0, 1)
```

```
short acc
```

```
GetData(acc, "Local HMI", LW, 3, 1)
```

```
SetData(acc, "MITSUBISHI MR J3 A", Acc, 0, 1)
```

```
short dist
```

```
GetData(dist, "Local HMI", LW, 4, 1)
```

```
SetData(dist, "MITSUBISHI MR J3 A", M_dist, 0, 1)
```

```
short rot_P
```

```
rot_P = 1 // Set to 0: Forward Rotation 1: Reverse Rotation
```

```
SetData(rot_P, "MITSUBISHI MR J3 A", Rot_P, 0, 1)
```

```
short rotat
```

```
rotat = 1 // See Note 3.
```

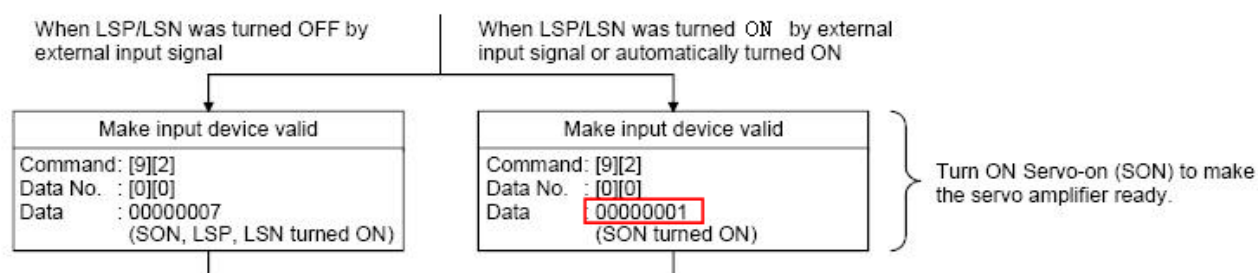


```
SetData(rotat, "MITSUBISHI MR J3 A", Rotation, 0, 1)
```

```
SetData(rot_P, "MITSUBISHI MR J3 A", P_start, 0, 1) // Start Positioning.
```

```
end macro_command
```

Note 3. Original Factory Manual



Wiring Diagram:

Diagram 1

cMT Series	cMT3151
eMT Series	eMT3070 / eMT3105 / eMT3120 / eMT3150
MT-iE	MT8070iE / MT6070iE / MT8100iE / MT8121iE / MT8150iE
MT-XE	MT8121XE / MT8150XE

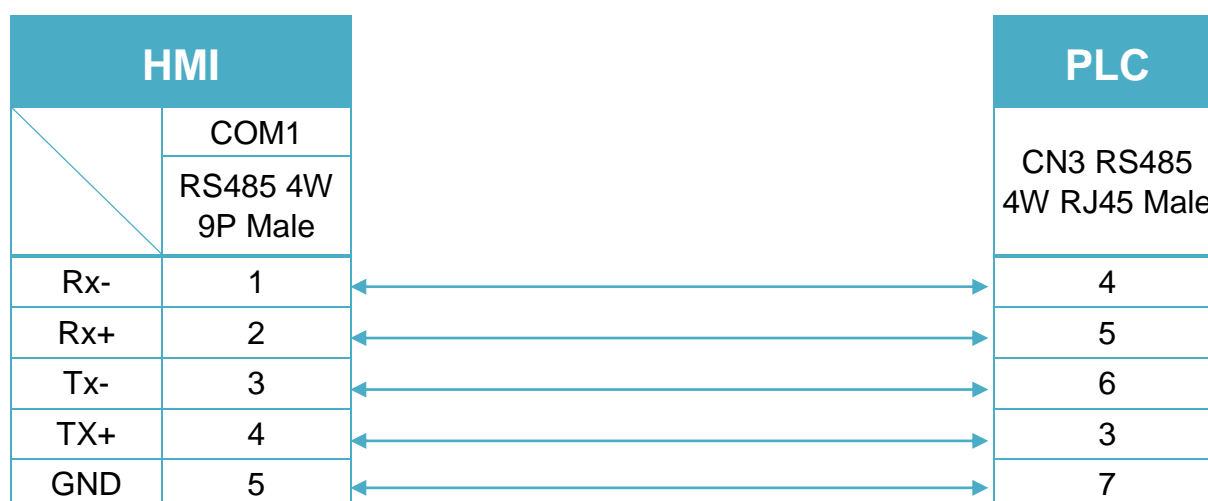


Diagram 2

cMT Series *cMT-SVR*

mTV *mTV*

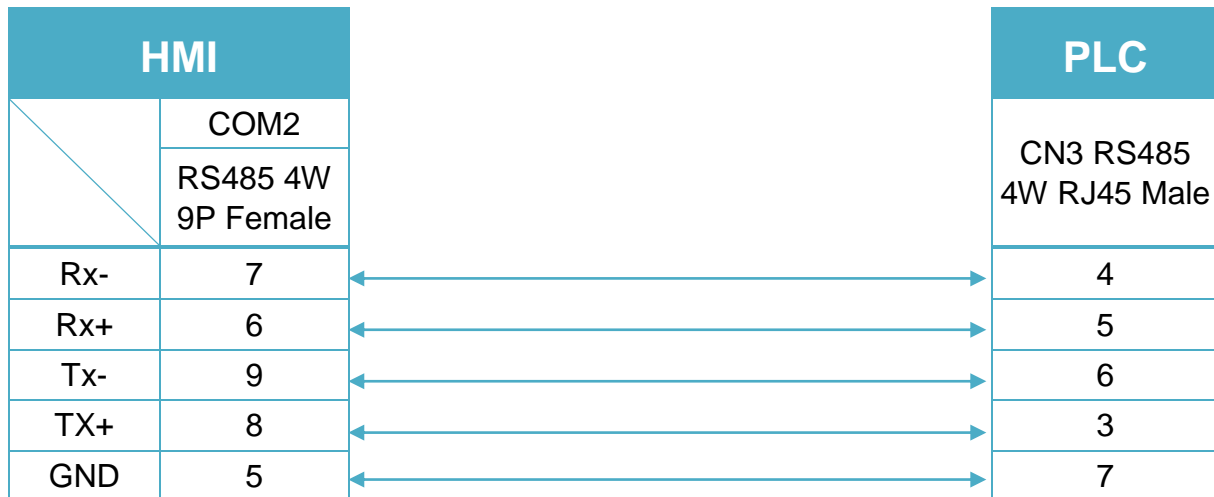


Diagram 3

MT-iE *MT8071iE / MT6071iE / MT8072iE / MT6072iE / MT8073iE /
MT8101iE / MT8102iE / MT8103iE*

MT-XE *MT8090XE / MT8092XE*

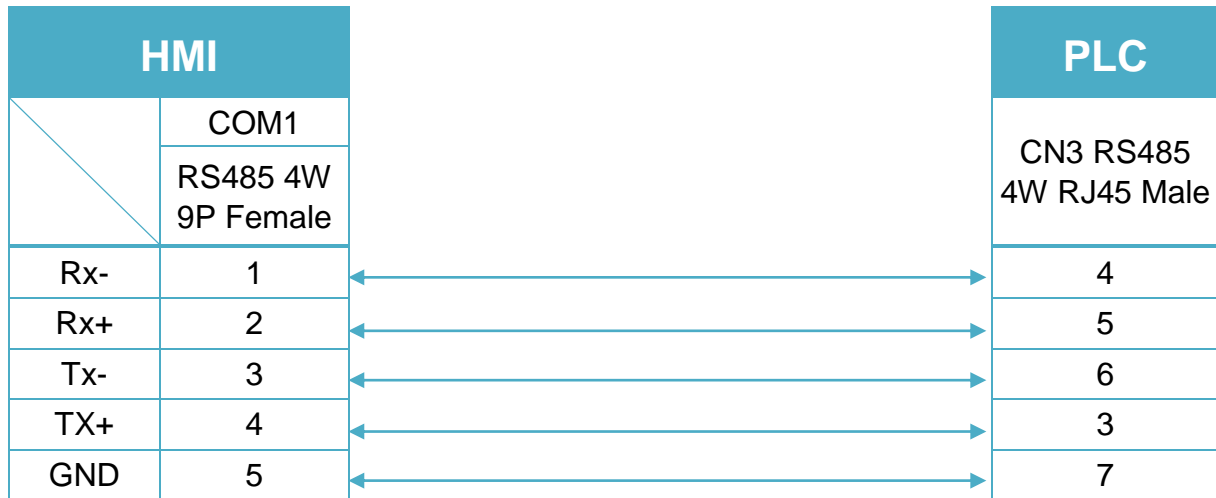
MT-iP *MT6071iP / MT8071iP / MT6103iP*



Diagram 4

MT-iE *MT8050iE*

MT-iP *MT6051iP*



Mitsubishi MR-MQ100 (Ethernet)

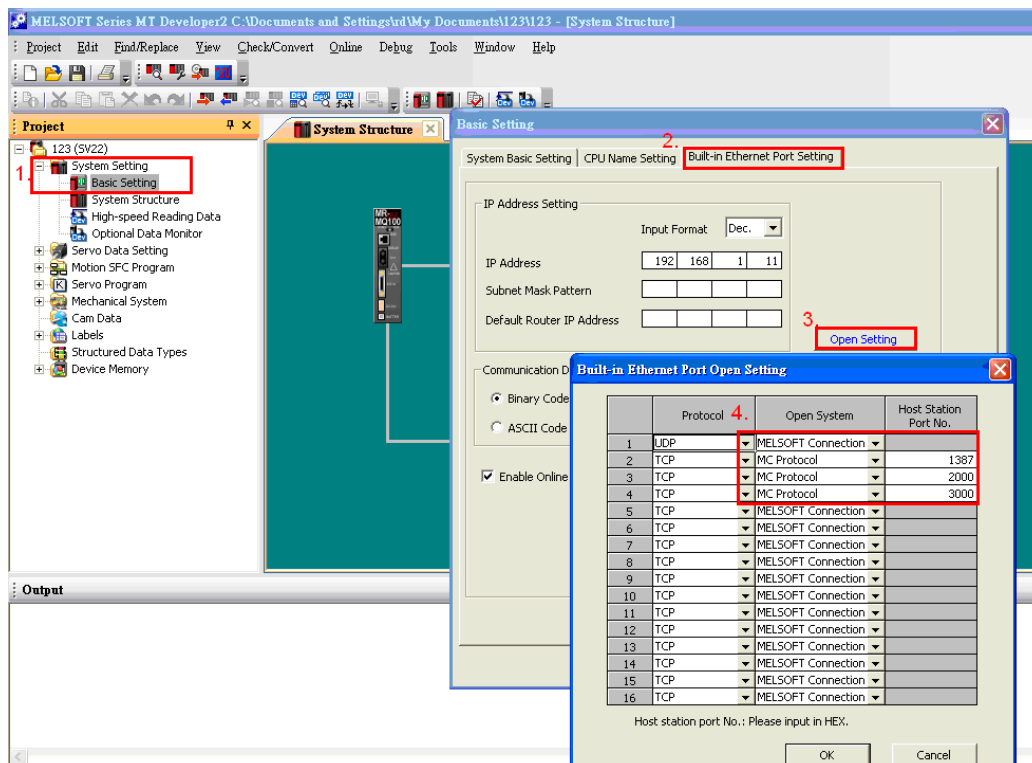
Supported Series: Mitsubishi MR-MQ100-Ethernet

Website: <http://www.mitsubishi-automation.com>

HMI Setting:

Parameters	Recommended	Options	Notes
PLC type	Mitsubishi MR-MQ100 (Ethernet)		
PLC I/F	Ethernet		
Port no.	Set identically to the PLC setting		Advised to set port no. to 4999
Parameter1	1		Network No.
PLC sta. no.	255		

PLC Setting:



1. Click [Basic Setting].
2. [Built-in Ethernet Port Setting].
3. Click [Open Setting] and then set the IP address and communication data code.
4. Set the MC Protocol-TCP Port No. (Hex)

Device Address:

Bit/Word	Device type	Format	Range	Memo
B	SM	DDDD	0 ~ 2255	Special Relay
B	X	HHHH	0 ~ 1fff	Input
B	Y	HHHH	0 ~ 1fff	Output
B	M	DDDDD	0 ~ 61439	Internal Relay
B	F	DDDDD	0 ~ 32767	Annunciator
B	B	HHHH	0 ~ eff	Link Relay
B	D_Bit	DDDDDDh	0 ~ 4184063f	
W	SD	DDDD	0 ~ 2255	Special Register
W	D	DDDDDD	0 ~ 4184063	Data Register
W	W	HHHHHH	0 ~ 3fd7ff	Link Register
W	#	DDDDD	0 ~ 12287	Motion Register

Note: ddd: Decimal, hhh: Hexadecimal, ooo: Octal.

Wiring Diagram:

Ethernet cable:



Mitsubishi Q00/Q00UJ/Q01/QJ71

Supported Series: Mitsubishi Q series PLC with QJ71C24 communication module, Q00, Q00J, Q00UJ, Q01, Q02H, Q06H, Q12H, Q25H, Q12PH, Q25PH CPU port.

Website: <http://www.mitsubishi-automation.com>

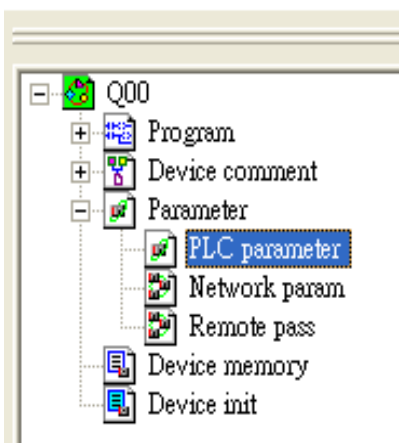
HMI Setting:

Parameters	Recommended	Options	Notes
PLC type	Mitsubishi Q00/Q00UJ/Q01/QJ71		
PLC I/F	RS232	RS485 2W/4W, RS232	
Baud rate	9600	9600~115200	
Data bits	8		
Parity	Odd		
Stop bits	1		
PLC sta. no.	0		

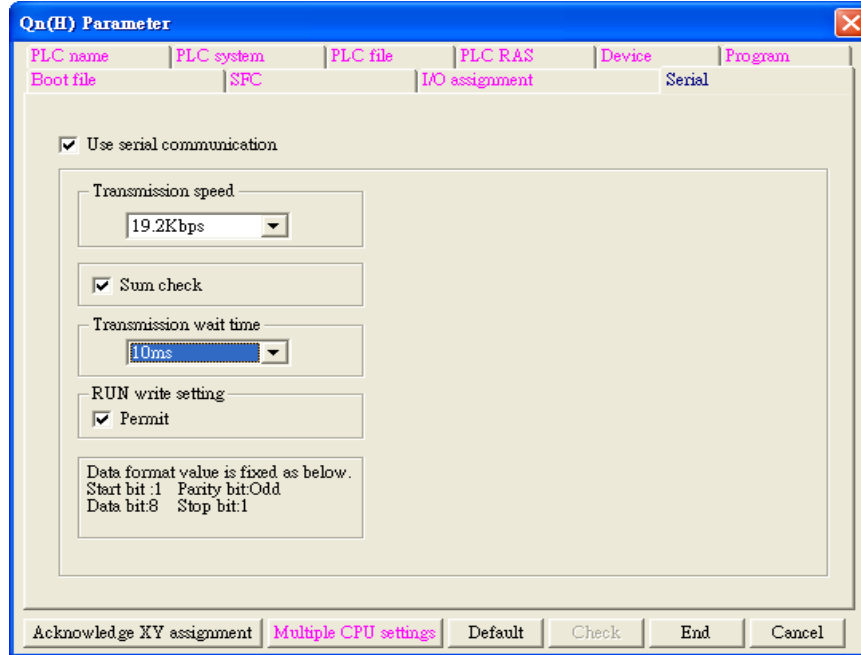
Online simulator	Yes	Extend address mode	NO
-------------------------	-----	----------------------------	----

PLC Setting:

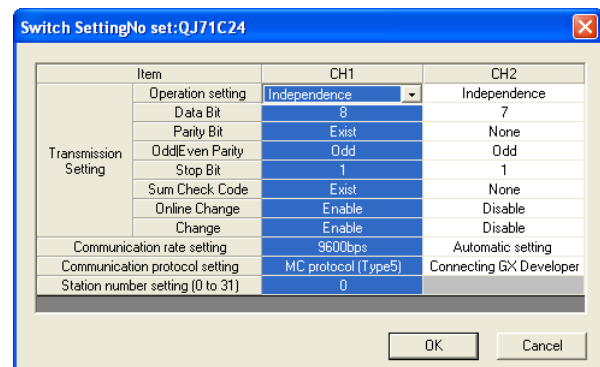
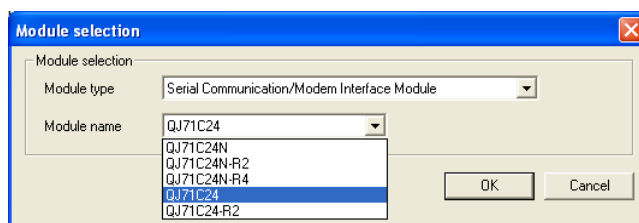
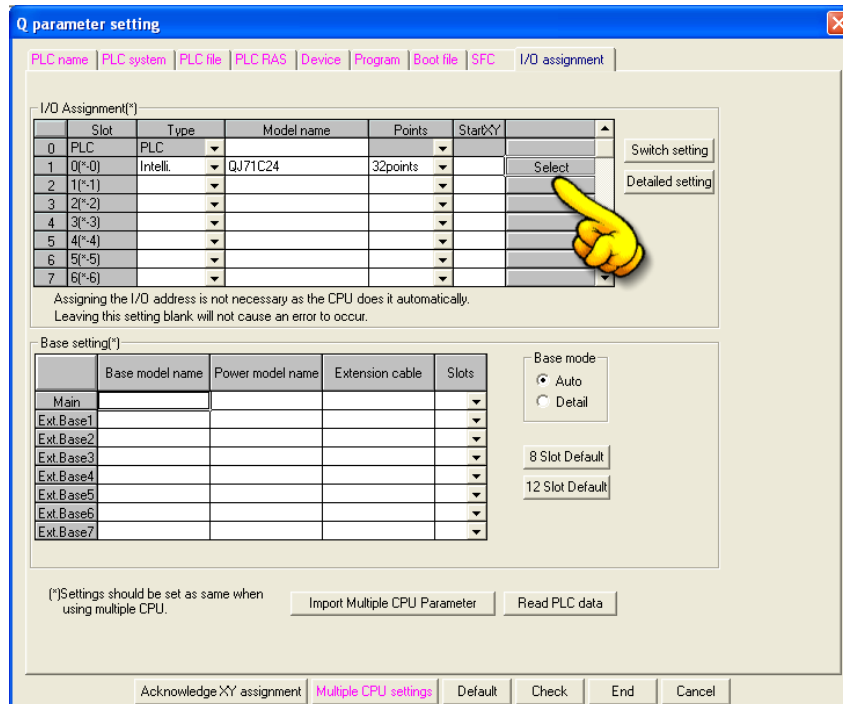
Q00, Q01 CPU port setting:



1. In GX Developer "PLC data list" click [PLC parameter].
2. In "PLC parameter" go to [Serial] page.
3. Select [Use serial communication].
4. Set [Transmission speed] to 9600~115200.
5. Select [Sum check].
6. Set [Transmission wait time] to 10ms.
7. Permit [RUN write setting].
8. Click [End] to close the dialog.
9. Write the PLC Parameter to PLC.
10. Reset PLC, the parameter will be activated.



QJ71 setting:



Device Address:

Bit/Word	Device type	Format	Range	Memo
B	X	HHHH	0 ~ 1fff	Input Relay
B	Y	HHHH	0 ~ 1fff	Output Relay
B	M	DDDDD	0 ~ 61439	Internal Relay
B	L	DDDDD	0 ~ 32767	Latch Relay
B	F	DDDDD	0 ~ 32767	Annunciator
B	V	DDDDD	0 ~ 32767	Edge Relay
B	B	HHHH	0 ~ efff	Link Relay
B	TC	DDDD	0 ~ 2047	Timer Coil
B	SS	DDDDD	0 ~ 25471	Retentive Timer Contact
B	SC	DDDDD	0 ~ 25471	Retentive Timer Coil
B	CS	DDDDD	0 ~ 25471	Counter Contact
B	CC	DDDDD	0 ~ 25471	Counter Coil
B	SB	HHH	0 ~ 7ff	Special Link Relay
B	S	DDDD	0 ~ 8191	Step Relay
B	DX	HHHH	0 ~ 1fff	Direct Input
B	DY	HHHH	0 ~ 1fff	Direct Output
B	TS	DDDD	0 ~ 2047	Timer Contact
B	SM	DDDD	0 ~ 2047	
B	D_Bit	DDDDDDDDh	0 ~ 4212735f	
B	W_Bit	HHHHh	0 ~ 2ffff	
B	ZR_Bit	HHHHHh	0 ~ fe7fff	
B	ZR_Dec_Bit	DDDDDDDDh	0 ~ 1042431f	
W	W	HHHH	0 ~ 2fff	Link Register
W	TN	DDDD	0 ~ 2047	Timer Current Value
W	SN	DDDD	0 ~ 2047	Retentive Timer Current Value
W	CN	DDDD	0 ~ 1023	Counter Current Value
W	R	FFDDDDD	0 ~ 3132767	File Register (FF:File No. 0~31) (DDDDD:0~32767)
W	SW	HHH	0 ~ 7ff	Special Link Register
W	Z	DD	0 ~ 19	Index Register
W	ZR	HHHHH	0 ~ fe7a5	File Register
W	ZR_decimal_addr	DDDDDDD	0 ~ 1042341	
W	D	DDDDDDD	0 ~ 4212735	Data Register
W	SD	DDDD	0 ~ 2047	
W	Serial_No	D	0 ~ 7	

Bit/Word	Device type	Format	Range	Memo
W	Product_No	D	0 ~ 7	

Wiring Diagram:

QJ71C24 CH.2 RS422 Terminal (Diagram 1 ~ Diagram 4)

Diagram 1

cMT Series	<i>cMT3151</i>
eMT Series	<i>eMT3070 / eMT3105 / eMT3120 / eMT3150</i>
MT-iE	<i>MT8070iE / MT6070iE / MT8100iE / MT8121iE / MT8150iE</i>
MT-XE	<i>MT8121XE / MT8150XE</i>

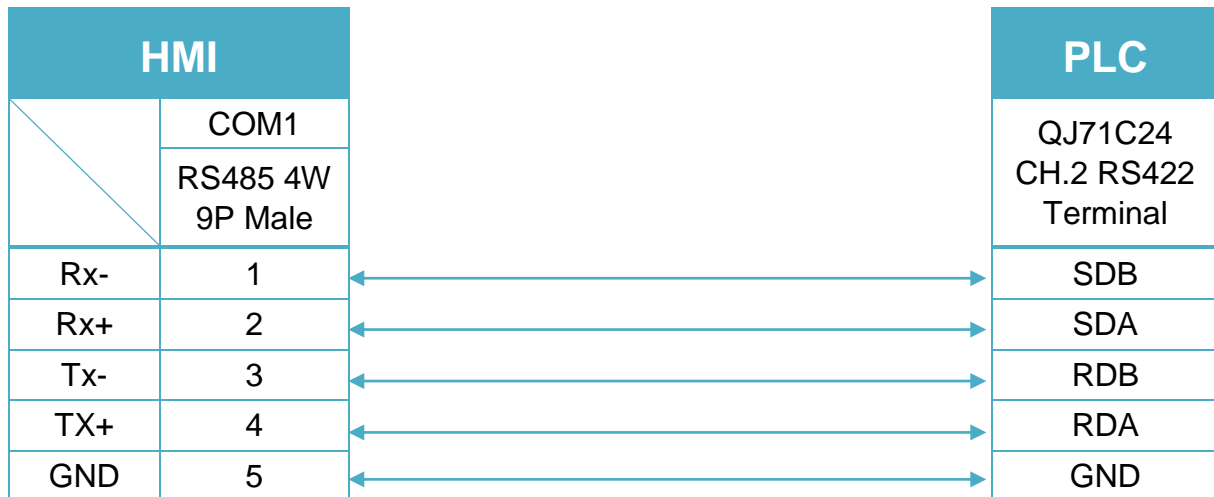


Diagram 2

cMT Series	<i>cMT-SVR</i>
mTV	<i>mTV</i>

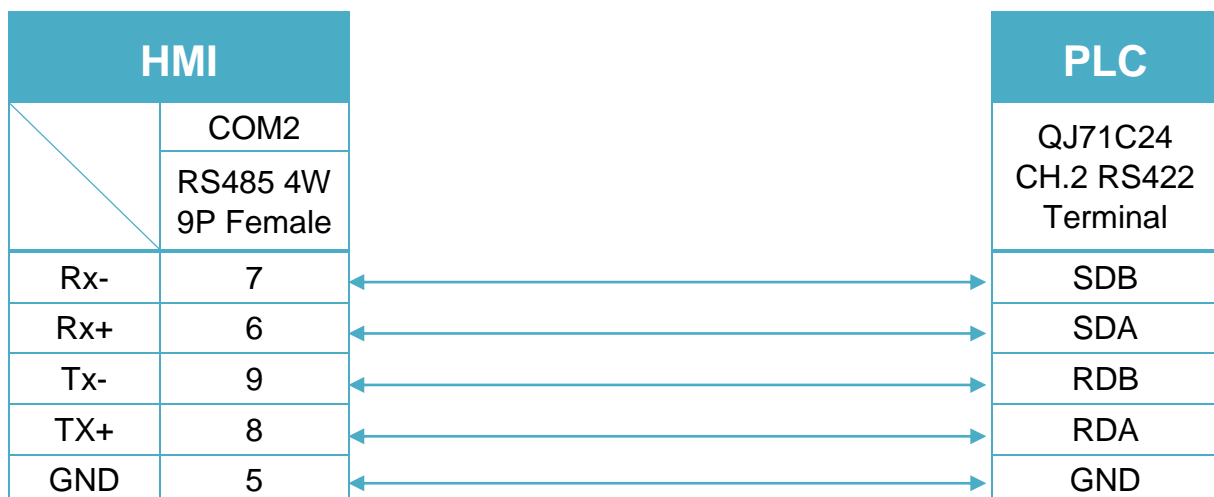


Diagram 3

MT-iE	<i>MT8071iE / MT6071iE / MT8072iE / MT6072iE / MT8073iE / MT8101iE / MT8102iE / MT8103iE</i>
MT-XE	<i>MT8090XE / MT8092XE</i>
MT-iP	<i>MT6071iP / MT8071iP / MT6103iP</i>

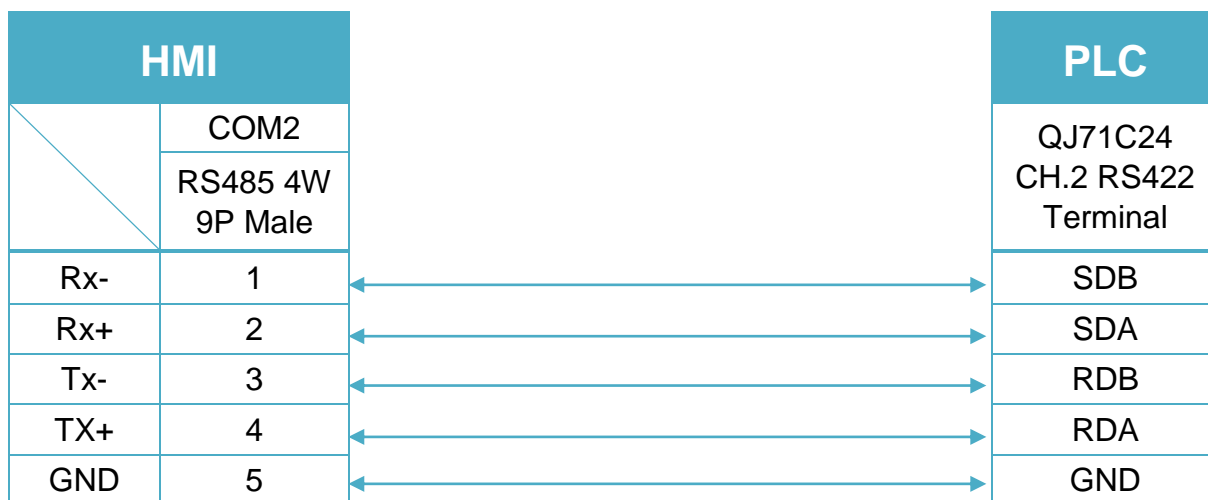
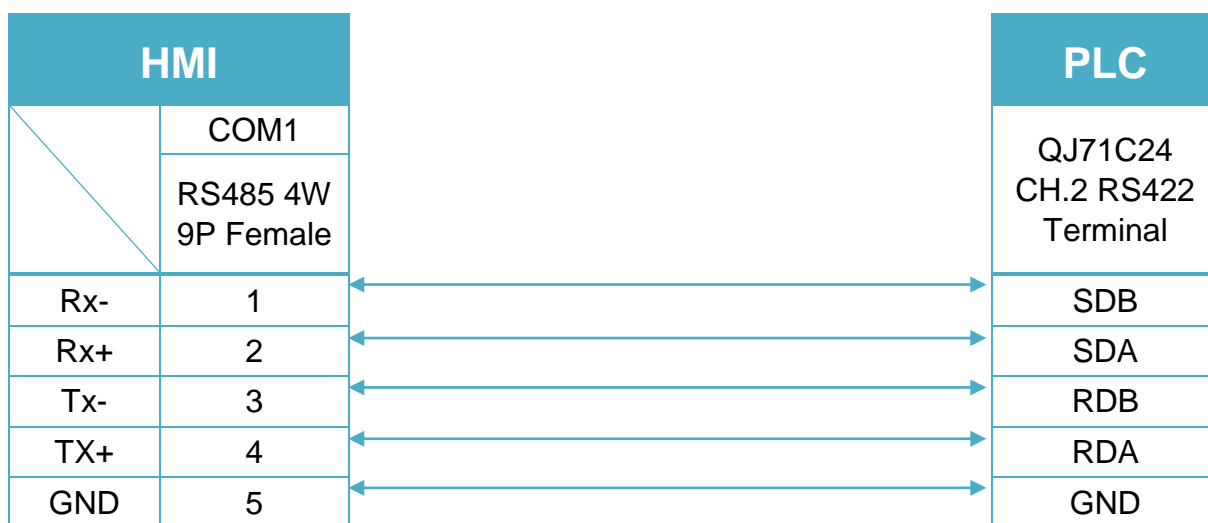


Diagram 4

MT-iE	<i>MT8050iE</i>
MT-iP	<i>MT6051iP</i>



QJ71C24 CH.2 RS232 (Diagram 5 ~ Diagram 7)

Diagram 5

cMT Series	<i>cMT3151</i>
eMT Series	<i>eMT3070 / eMT3105 / eMT3120 / eMT3150</i>
MT-iE	<i>MT8073iE / MT8102iE</i>
MT-XE	<i>MT8092XE</i>
MT-iP	<i>MT6103iP</i>

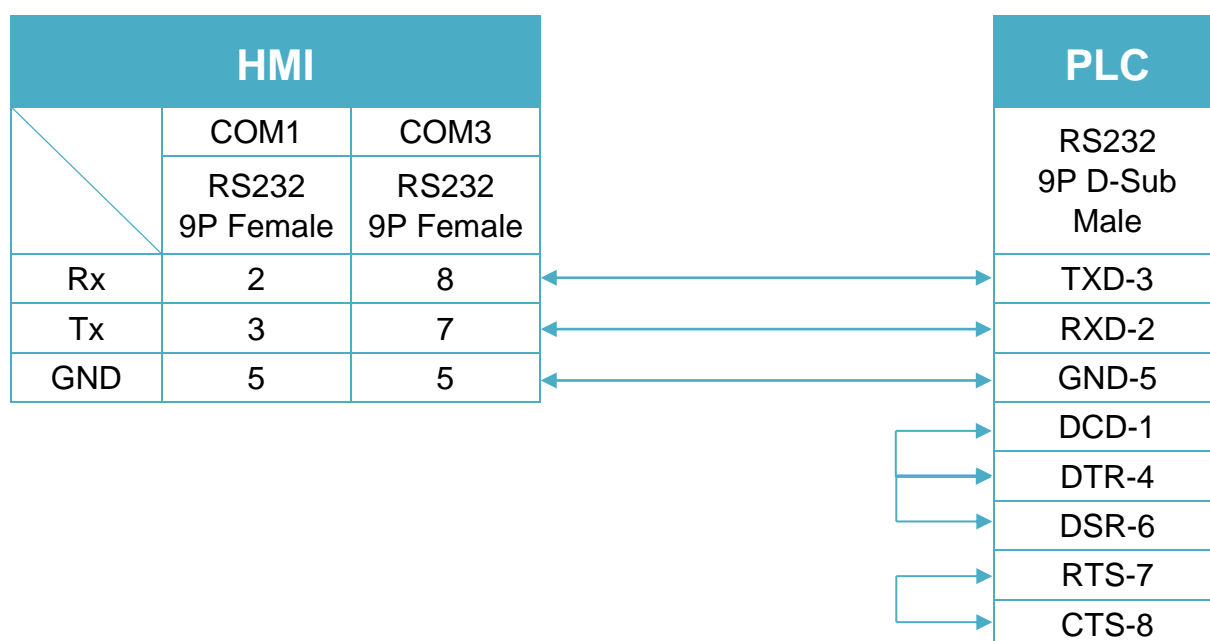


Diagram 6

cMT Series	<i>cMT-SVR</i>
mTV	<i>mTV</i>
MT-iE	<i>MT8070iE / MT6070iE / MT8100iE / MT8121iE / MT8150iE / MT8071iE / MT6071iE / MT8072iE / MT6072iE / MT8073iE / MT8101iE / MT8102iE / MT8103iE</i>
MT-XE	<i>MT8121XE / MT8150XE / MT8090XE /</i>

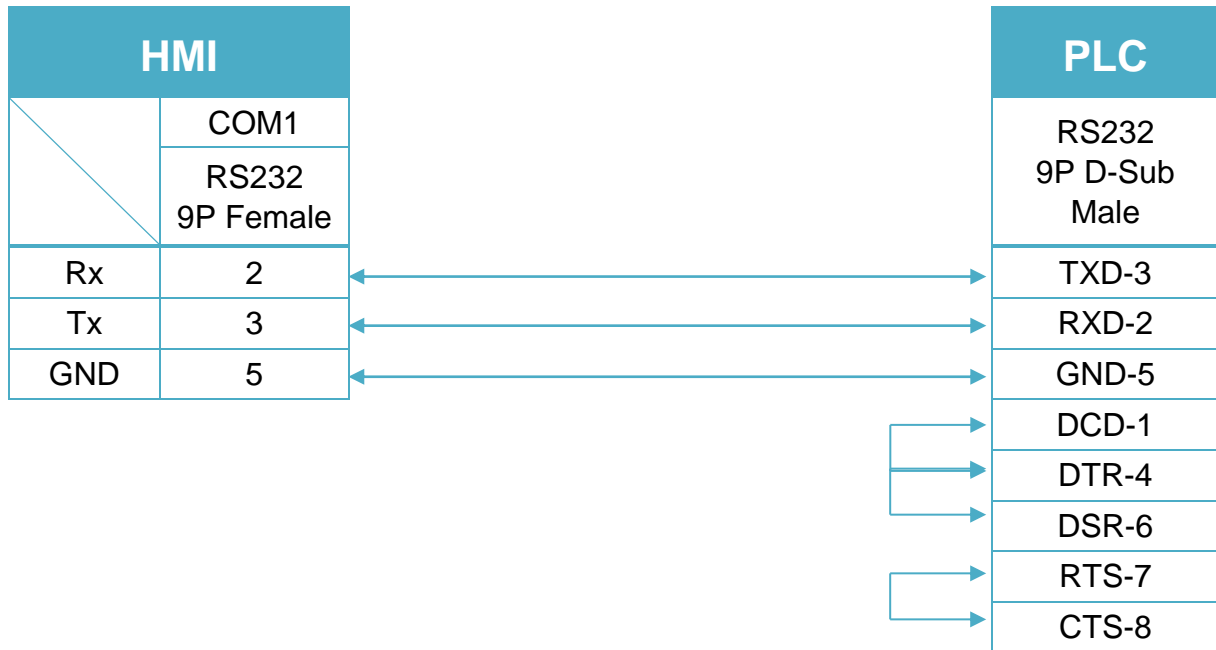
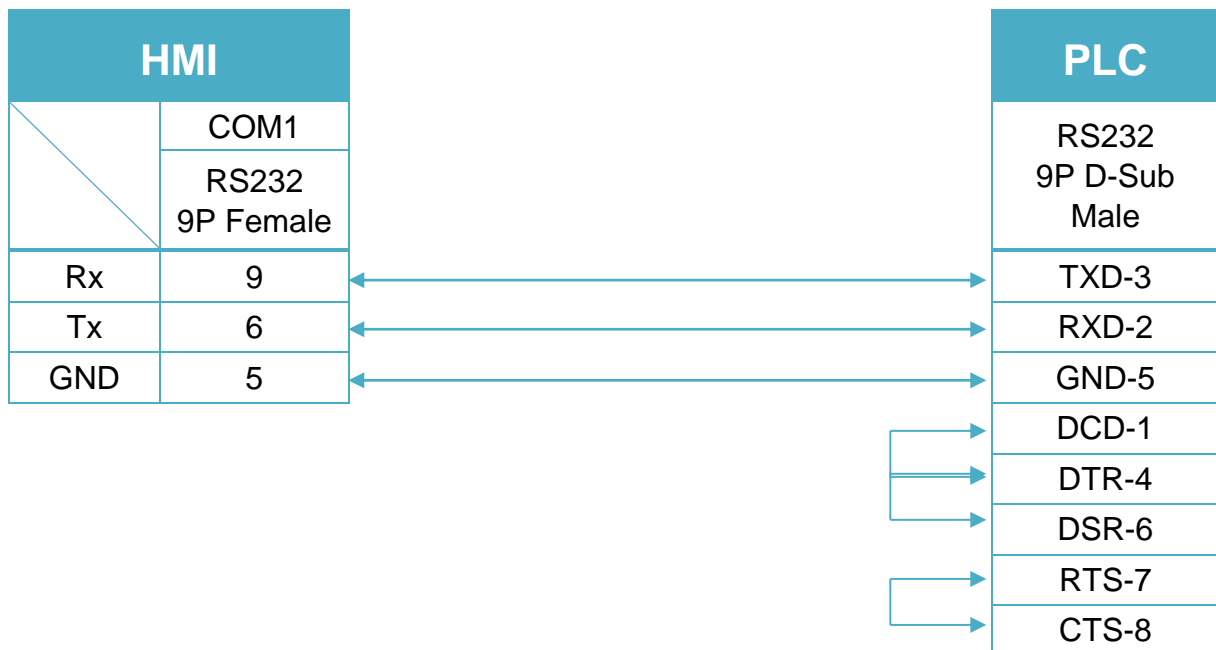


Diagram 7

MT-iE
MT8050iE
MT-iP
MT6051iP / MT6071iP / MT8071iP


6P Mini-DIN: Q00, Q01 CPU port RS232 (Diagram 8 ~ Diagram 10)

The following is the view from the soldering point of a connector.

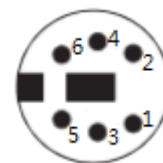


Diagram 8

cMT Series	<i>cMT3151</i>
eMT Series	<i>eMT3070 / eMT3105 / eMT3120 / eMT3150</i>
MT-iE	<i>MT8073iE / MT8102iE</i>
MT-XE	<i>MT8092XE</i>
MT-iP	<i>MT6103iP</i>

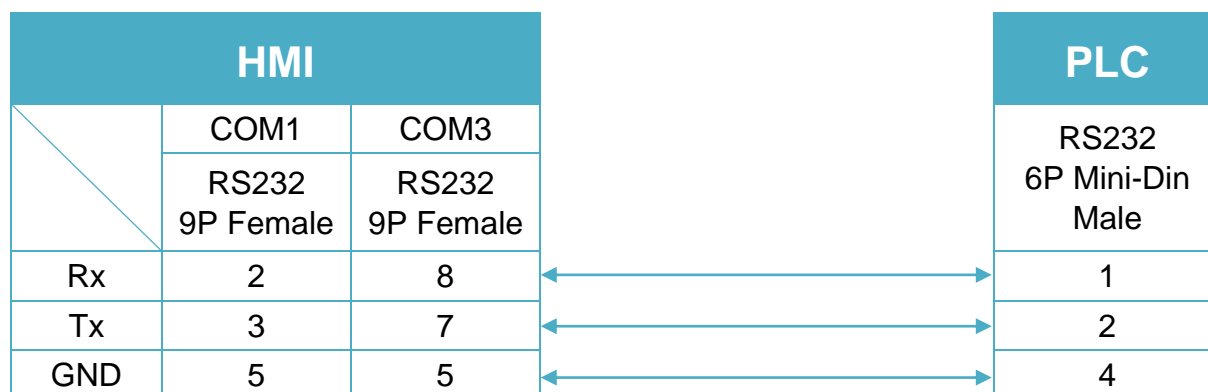


Diagram 9

cMT Series	cMT-SVR
mTV	mTV
MT-iE	MT8070iE / MT6070iE / MT8100iE / MT8121iE / MT8150iE / MT8071iE / MT6071iE / MT8072iE / MT6072iE / MT8073iE / MT8101iE / MT8102iE / MT8103iE
MT-XE	MT8121XE / MT8150XE / MT8090XE /

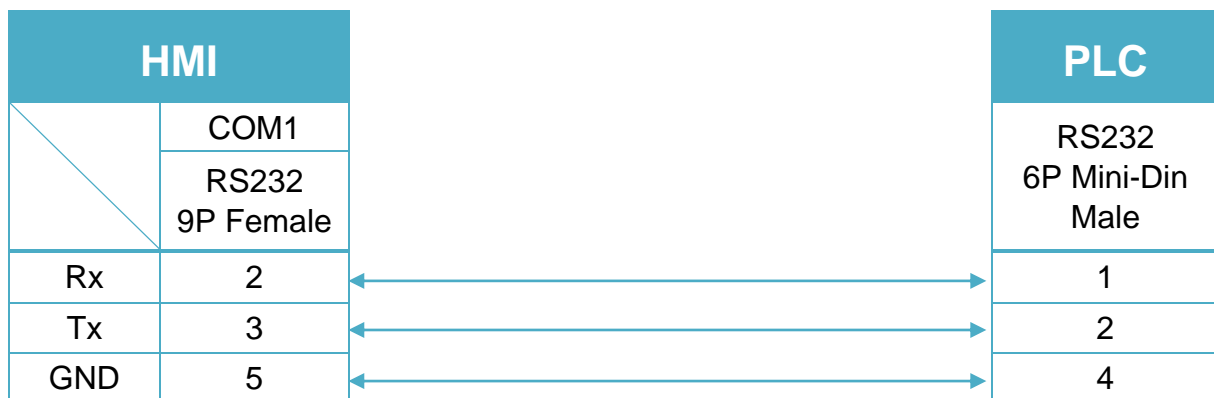


Diagram 10

MT-iE	MT8050iE
MT-iP	MT6051iP / MT6071iP / MT8071iP



6P Mini-DIN: Q00UJ CPU port RS232 (Diagram 11 ~ Diagram 13)

The following is the view from the soldering point of a connector.

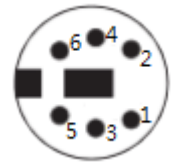


Diagram 11

cMT Series	cMT3151
eMT Series	eMT3070 / eMT3105 / eMT3120 / eMT3150
MT-iE	MT8073iE / MT8102iE
MT-XE	MT8092XE
MT-iP	MT6103iP

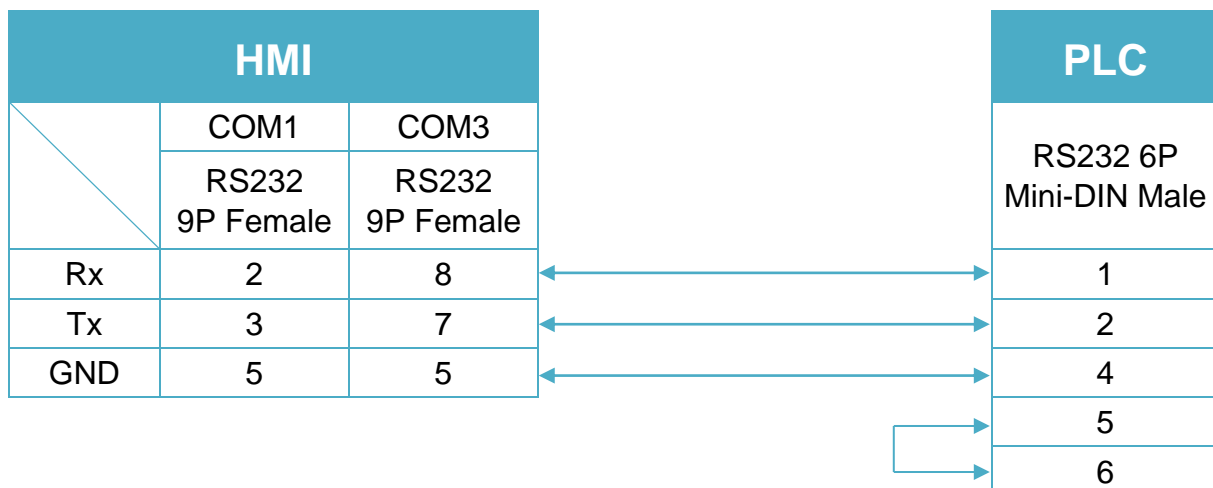


Diagram 12

cMT Series	cMT-SVR
mTV	mTV
MT-iE	MT8070iE / MT6070iE / MT8100iE / MT8121iE / MT8150iE / MT8071iE / MT6071iE / MT8072iE / MT6072iE / MT8073iE / MT8101iE / MT8102iE / MT8103iE
MT-XE	MT8121XE / MT8150XE / MT8090XE /

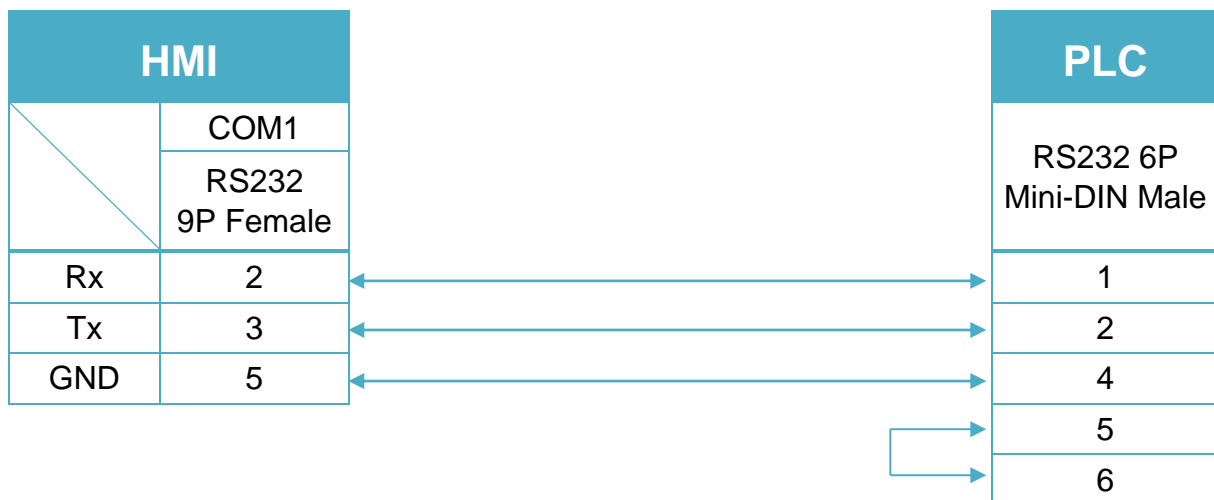
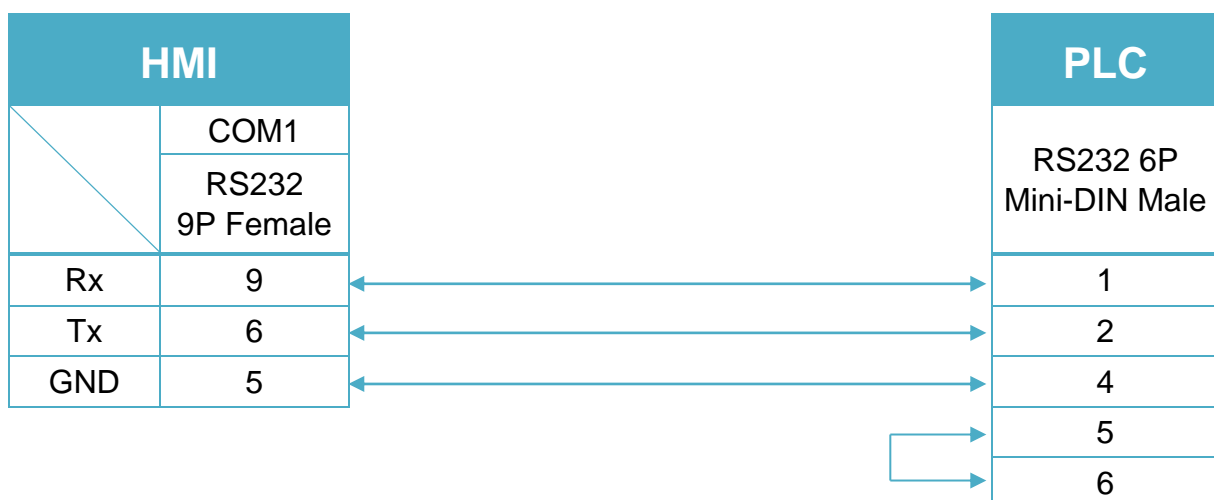


Diagram 13

MT-iE	MT8050iE
MT-iP	MT6051iP / MT6071iP / MT8071iP



Mitsubishi Q00J

Supported Series: Mitsubishi Q00J CPU

HMI Setting:

Parameters	Recommended	Options	Notes
PLC type	Mitsubishi Q00J		
PLC I/F	RS232		CPU port
Baud rate	115200	9600,19200,38400, 57600,115200	
Data bits	8		
Parity	Odd		
Stop bits	1		
PLC sta. no.			

Online simulator	NO	Extend address mode	NO
-------------------------	----	----------------------------	----

*Support communications between HMI and PLC in pass-through mode

*Set LW-9903 to 2 to enhance the speed of download/upload PLC program in pass-through mode

Device Address:

Bit/Word	Device	Format	Range	Memo
B	SM	DDDD	0 ~ 1023	
B	X	HHH	0 ~ 7ff	
B	Y	HHH	0 ~ 7ff	
B	M	DDDDD	0 ~ 61439	
B	L	DDDD	0 ~ 2047	
B	F	DDDD	0 ~ 1023	
B	V	DDDD	0 ~ 1023	
B	B	HHH	0 ~ 7ff	
B	SB	HHH	0 ~ 3ff	
B	D_Bit	DDDDDDh	0 ~ 4212735f	
W	SD	DDDD	0 ~ 1023	
W	D	DDDDDD	0 ~ 4212735	
W	W	HHH	0 ~ 7ff	
W	SW	HHH	0 ~ 3ff	

Bit/Word	Device	Format	Range	Memo
W	Z	D	0 ~ 9	
W	C	DDD	0 ~ 511	
W	T	DDD	0 ~ 511	

Wiring Diagram:

The following is the view from the soldering point of a connector.

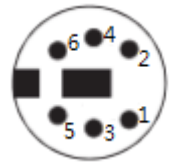


Diagram 1

cMT Series	<i>cMT3151</i>
eMT Series	<i>eMT3070 / eMT3105 / eMT3120 / eMT3150</i>
MT-iE	<i>MT8073iE / MT8102iE</i>
MT-XE	<i>MT8092XE</i>
MT-iP	<i>MT6103iP</i>

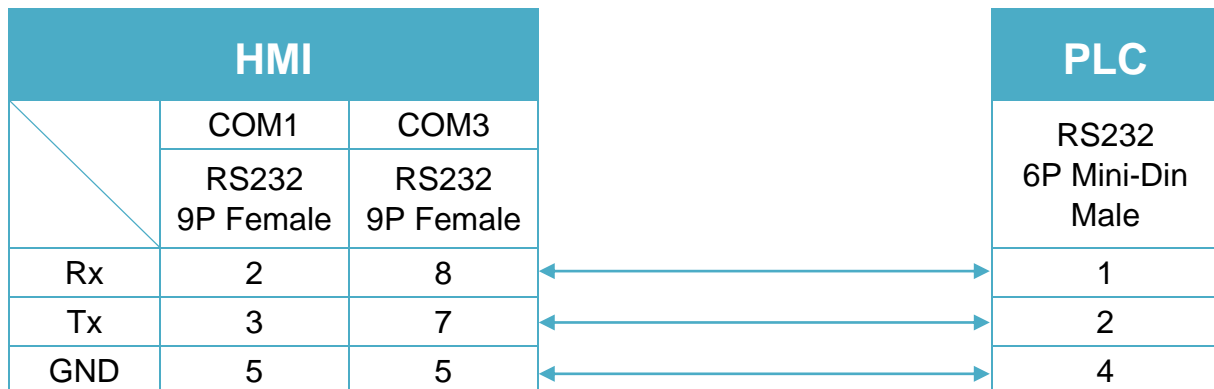


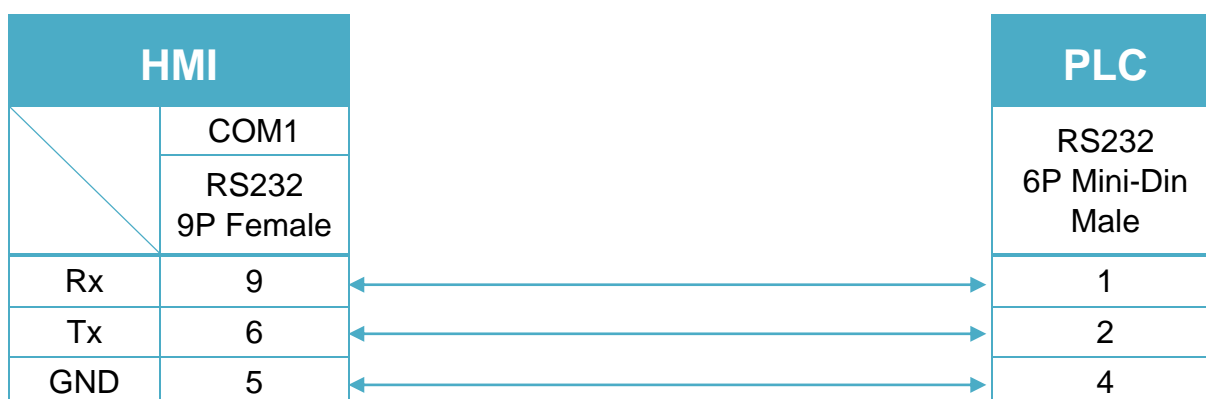
Diagram 2

cMT Series	cMT-SVR
mTV	mTV
MT-iE	MT8070iE / MT6070iE / MT8100iE / MT8121iE / MT8150iE / MT8071iE / MT6071iE / MT8072iE / MT6072iE / MT8073iE / MT8101iE / MT8102iE / MT8103iE
MT-XE	MT8121XE / MT8150XE / MT8090XE /



Diagram 3

MT-iE	MT8050iE
MT-iP	MT6051iP / MT6071iP / MT8071iP



MT8-Mitsubishi-Q-3M cable can connect HMI with Mitsubishi Q series directly.

Mitsubishi Q00U/Q01U/Q02U/QnUD/QnUDH

Supported Series: Mitsubishi Q00U, Q01U, Q02U, Q03UD, Q04UDH, Q06UDH, Q10UDH, Q13UDH, Q20UDH, Q26UDH, Q00UJ CPU.

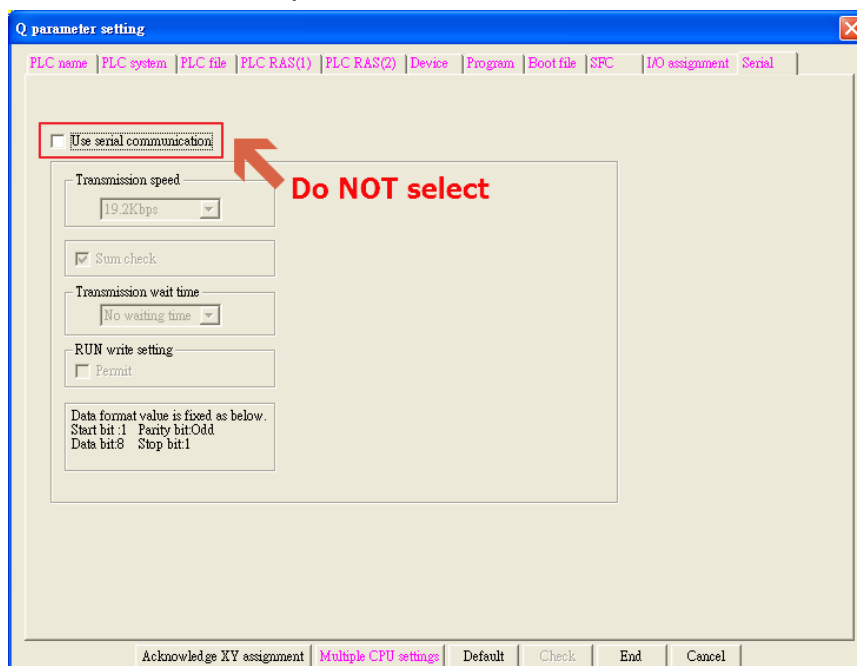
HMI Setting:

Parameters	Recommended	Options	Notes
PLC type	Mitsubishi Q00U/Q01U/Q02U/QnUD/QnUDH		
PLC I/F	RS232	RS485 4W, RS232	CPU port direct connect
Baud rate	115200	9600~115200	For Q00UJ, only 9600 is available
Data bits	8		
Parity	Odd		
Stop bits	1		
PLC sta. no.	No		

Online simulator	NO	Extend address mode	NO
-------------------------	----	----------------------------	----

PLC Setting:

Please **do not** select **[Use Serial Communication]**. If this is selected the communication method will be the same as QJ71, please refer to Mitsubishi Q00/Q00UJ/Q01/QJ71 driver.



Device Address:

Bit/Word	Device type	Format	Range	Memo
B	SM	DDDD	0 ~ 2047	
B	X	HHHH	0 ~ 1fff	Input Relay
B	Y	HHHH	0 ~ 1fff	Output Relay
B	M	DDDDD	0 ~ 61439	Internal Relay
B	L	DDDDD	0 ~ 32767	Latch Relay
B	F	DDDDD	0 ~ 32767	Annunciator
B	V	DDDDD	0 ~ 32767	Edge Relay
B	B	HHHH	0 ~ efff	Link Relay
B	SB	HHHH	0 ~ 7fff	Special Link Relay
B	TC	DDDDD	0 ~ 2047	Timer Coil
B	CC	DDDDD	0 ~ 1023	Counter Coil
B	D_Bit	DDDDDDh	0 ~ 4212735f	
B	W_Bit	HHHHHHh	0 ~ 4047fff	
B	ZR_Bit	HHHHHh	0 ~ fe7fff	
B	ZR_Dec_Bit	DDDDDDh	0 ~ 1042431f	
W	SD	DDDD	0 ~ 2047	
W	D	DDDDDD	0 ~ 4212735	Data Register
W	W	HHHHHH	0 ~ 4047ff	Link Register
W	SW	HHHH	0 ~ 6dff	Special Link Register
W	Z	DD	0 ~ 19	Index Register
W	R	FFDDDDD	0 ~ 3132767	File Register (FF:File No. 0~31) (DDDDD:0~32767)
W	ZR	HHHHHH	0 ~ fe7ff	File Register
W	ZR_decimal_addr	DDDDDD	0 ~ 1042341	
W	C	DDDDD	0 ~ 25471	Counter Current Value
W	T	DDDDD	0 ~ 25471	Timer Current Value

Note:

EasyBuilder doesn't support MITSUBISHI Q02U CPU to do on-line simulation on PC. When using Q02U driver, HMI needs 10 seconds to initiate PLC Q02U driver. Before the completion of initiation, it is recommended not to write data to PLC, this could cause "PLC no response"; Incorrect wiring or data could cause PLC to be locked. If PLC is locked, please restart PLC or reinstall PLC module.

Wiring Diagram:

6P Mini-DIN: Q02 CPU port RS232 (Diagram 1 ~ Diagram 3)

The following is the view from the soldering point of a connector.

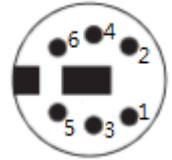


Diagram 1

cMT Series	cMT3151
eMT Series	eMT3070 / eMT3105 / eMT3120 / eMT3150
MT-iE	MT8073iE / MT8102iE
MT-XE	MT8092XE
MT-iP	MT6103iP

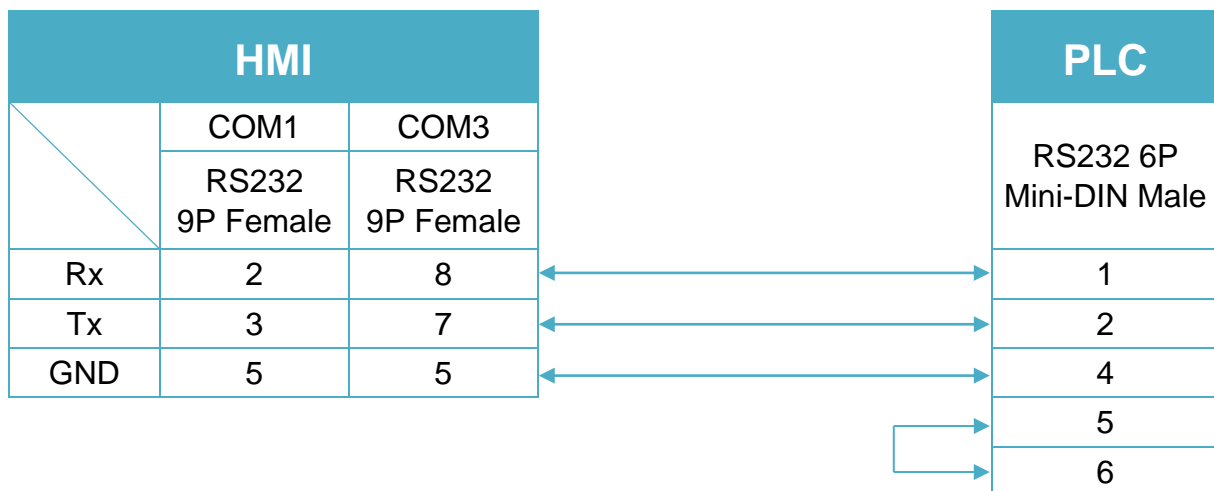


Diagram 2

cMT Series	cMT-SVR
mTV	mTV
MT-iE	MT8070iE / MT6070iE / MT8100iE / MT8121iE / MT8150iE / MT8071iE / MT6071iE / MT8072iE / MT6072iE / MT8073iE / MT8101iE / MT8102iE / MT8103iE
MT-XE	MT8121XE / MT8150XE / MT8090XE /

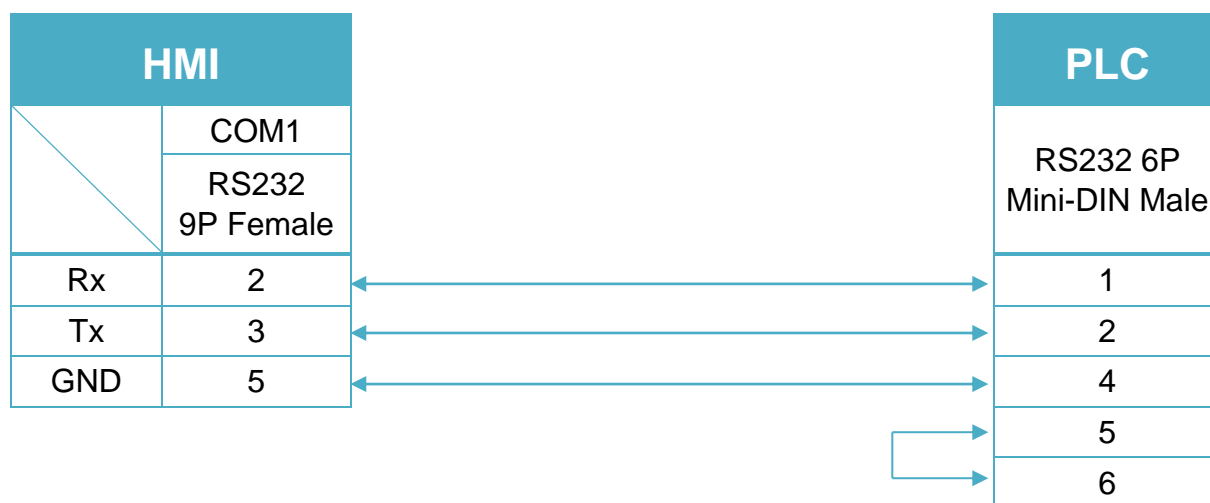
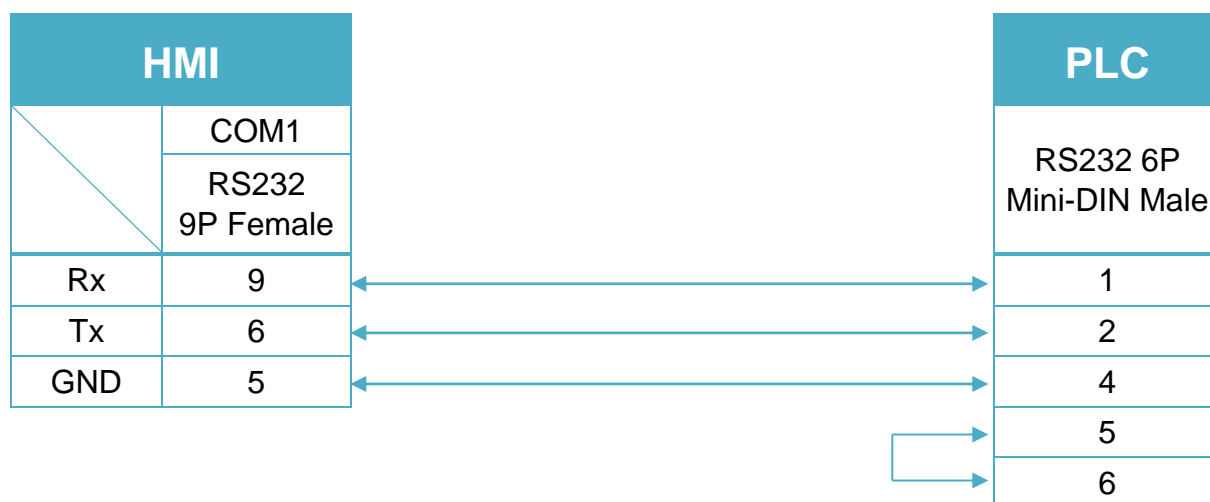


Diagram 3

MT-iE	MT8050iE
MT-iP	MT6051iP / MT6071iP / MT8071iP



Mitsubishi Q00UJ/QnU/QnUD/QnUDH/QnUDEH/L (mini USB)

Supported Series: Mitsubishi Q00UJ, Q00U, Q01U, Q02U, Q03UDE, Q03UD, Q04UDEH, Q04UDH, Q06UDEH, Q06UDH, Q10UDEH, Q10UDH, Q13UDEH, Q13UDH, Q20UDEH, Q20UDH, Q26UDEH, Q26UDH, L02, L26-BT USB Port.

HMI Setting:

Parameters	Recommended	Options	Notes
PLC type	Mitsubishi Q00UJ/QnU/QnUD/QnUDH/QnUDEH/L (mini USB)		
PLC I/F	USB		CPU port direct connect

Device Address:

Bit/Word	Device type	Format	Range	Memo
B	SM	DDDD	0 ~ 2047	
B	X	HHHH	0 ~ 1fff	Input Relay
B	Y	HHHH	0 ~ 1fff	Output Relay
B	M	DDDDD	0 ~ 61439	Internal Relay
B	L	DDDD	0 ~ 8191	Latch Relay
B	F	DDDD	0 ~ 2047	Annunciator
B	V	DDDD	0 ~ 2047	Edge Relay
B	B	HHHH	0 ~ 1fff	Link Relay
B	SB	HHH	0 ~ 7ff	Special Link Relay
B	D_Bit	DDDDDDh	0 ~ 4212735f	
B	ZR_Bit	HHHHh	0 ~ ffff	
B	ZR_Dec_Bit	DDDDh	0 ~ 65535f	
W	SD	DDDD	0 ~ 2047	
W	D	DDDDDD	0 ~ 4212735	Data Register
W	W	HHHH	0 ~ 1fff	Link Register
W	SW	HHH	0 ~ 7ff	Special Link Register
W	Z	DD	0 ~ 19	Index Register
W	R	FFDDDD	0 ~ 132767	File Register (FF:File No. 0~31) (DDDDD:0~32767)
W	ZR	HHHH	0 ~ ffff	File Register
W	ZR_decimal_addr	DDDDD	0 ~ 65535	

Bit/Word	Device type	Format	Range	Memo
W	C	DDDD	0 ~ 1023	Counter Current Value
W	T	DDDD	0 ~ 2047	Timer Current Value

Note:

EasyBuilder doesn't support MITSUBISHI Q02U CPU to do on-line simulation on PC. When using Q02U driver, HMI needs 10 seconds to initiate PLC Q02U driver. Before the completion of initiation, it is recommended not to write data to PLC, this could cause "PLC no response" ; Incorrect wiring or data could cause PLC to be locked. If PLC is locked, please restart PLC or reinstall PLC module.

Mitsubishi Q02/02H

Supported Series; Mitsubishi Q02/Q02H CPU port.

Website: <http://www.mitsubishi-automation.com>

HMI Setting:

Parameters	Recommended	Options	Notes
PLC type	Mitsubishi Q02/02H		
PLC I/F	RS232	RS485 4W, RS232	
Baud rate	115200	115200 only	
Data bits	8		
Parity	Odd		
Stop bits	1		
PLC sta. no.	0		

Online simulator	YES	Extend address mode	NO
Broadcast command	NO		

*Support communications between HMI and PLC in pass-through mode

*Set LW-9903 to 2 to enhance the speed of download/upload PLC program in pass-through mode

Device Address:

Bit/Word	Device type	Format	Range	Memo
B	SM	DDDD	0 ~ 2047	
B	X	HHHH	0 ~ 1fff	Input Relay
B	Y	HHHH	0 ~ 1fff	Output Relay
B	M	DDDDD	0 ~ 61439	Internal Relay
B	L	DDDDD	0 ~ 32767	Latch Relay
B	F	DDDDD	0 ~ 32767	Annunciator
B	V	DDDDD	0 ~ 32767	Edge Relay
B	B	HHHH	0 ~ 7fff	Link Relay
B	TC	DDDDD	0 ~ 23087	Timer Coil
B	SS	DDDDD	0 ~ 23087	Retentive Timer Contact
B	SC	DDDDD	0 ~ 23087	Retentive Timer Coil
B	CS	DDDDD	0 ~ 23087	Counter Contact
B	CC	DDDDD	0 ~ 23087	Counter Coil

Bit/Word	Device type	Format	Range	Memo
B	SB	HHH	0 ~ 7ff	Special Link Relay
B	S	DDDD	0 ~ 8191	Step Relay
B	DX	HHHH	0 ~ 1fff	Direct Input
B	DY	HHHH	0 ~ 1fff	Direct Output
B	TS	DDDD	0 ~ 2047	Timer Contact
B	D_Bit	DDDDDDDDh	0 ~ 4212735f	
B	ZR_Bit	HHHHHh	0 ~ fe7fff	
B	ZR_Dec_Bit	DDDDDDDDh	0 ~ 1042431f	
W	W	HHHH	0 ~ 657f	Link Register
W	TN	DDDD	0 ~ 23087	Timer Current Value
W	SN	DDDD	0 ~ 23087	Retentive Timer Current Value
W	CN	DDDD	0 ~ 23087	Counter Current Value
W	R	FFDDDD	0 ~ 3132767	File Register (FF:File No.)
W	SW	HHH	0 ~ 7ff	Special Link Register
W	Z	DD	0 ~ 15	Index Register
W	ZR	HHHHH	0 ~ fe7ff	File Register
W	ZR_decimal_addr	DDDDDD	0 ~ 1042431	
W	D	DDDDDD	0 ~ 4212735	Data Register

Wiring Diagram:

6P Mini-DIN: Q02 CPU port RS232 (Diagram 1 ~ Diagram 3)

The following is the view from the soldering point of a connector.

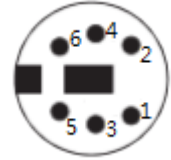


Diagram 1

cMT Series	cMT3151
eMT Series	eMT3070 / eMT3105 / eMT3120 / eMT3150
MT-iE	MT8073iE / MT8102iE
MT-XE	MT8092XE
MT-iP	MT6103iP

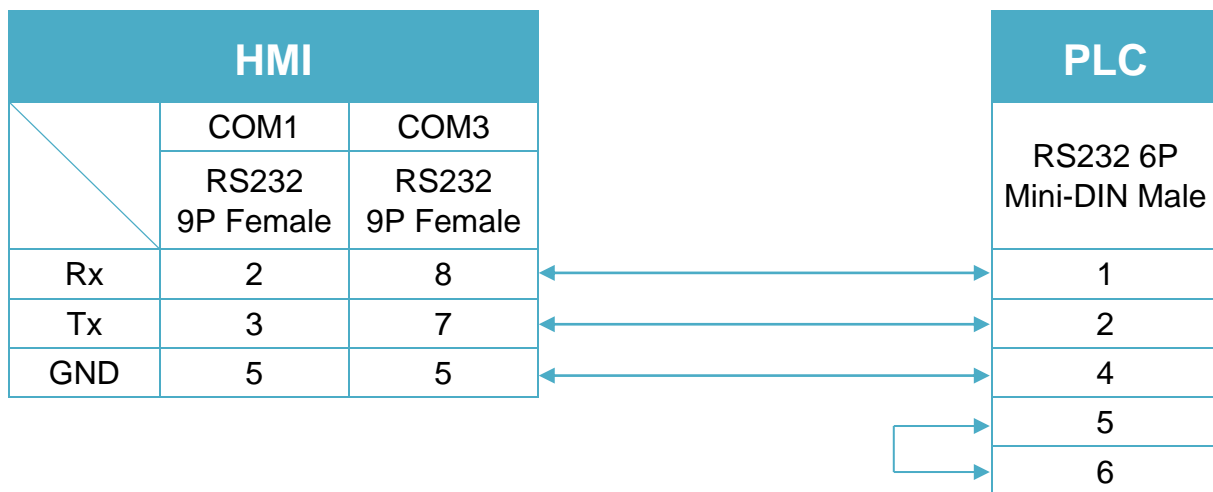


Diagram 2

cMT Series	cMT-SVR
mTV	mTV
MT-iE	MT8070iE / MT6070iE / MT8100iE / MT8121iE / MT8150iE / MT8071iE / MT6071iE / MT8072iE / MT6072iE / MT8073iE / MT8101iE / MT8102iE / MT8103iE
MT-XE	MT8121XE / MT8150XE / MT8090XE /

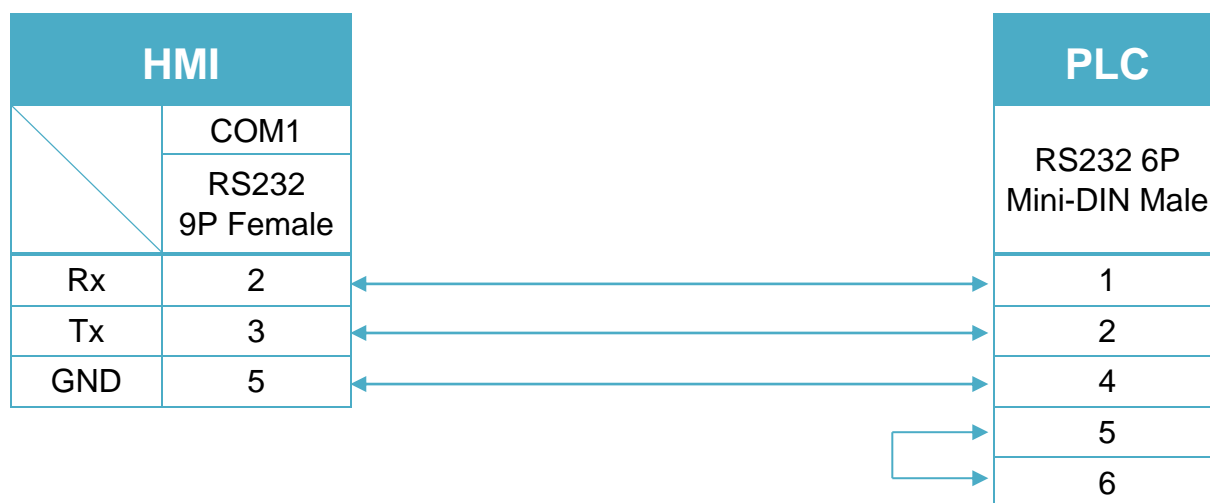
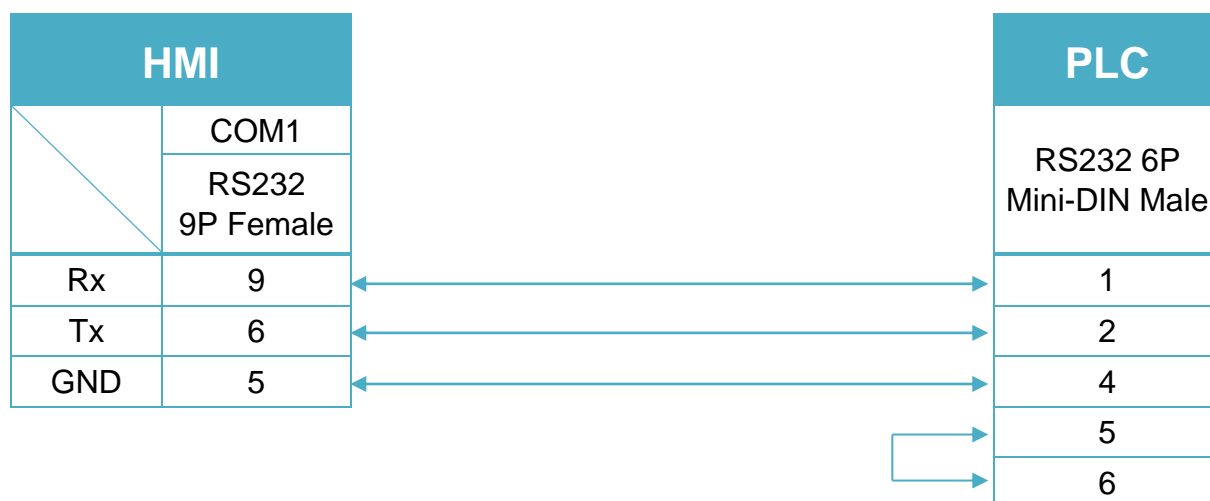


Diagram 3

MT-iE	MT8050iE
MT-iP	MT6051iP / MT6071iP / MT8071iP



Mitsubishi Q06H

Supported Series: Mitsubishi Q06H CPU port.

Website: <http://www.mitsubishi-automation.com>

HMI Setting:

Parameters	Recommended	Options	Notes
PLC type	Mitsubishi Q06H		
PLC I/F	RS232	RS485 4W, RS232	
Baud rate	115200	115200 only	
Data bits	8		
Parity	Odd		
Stop bits	1		
PLC sta. no.	0		

Online simulator	YES	Extend address mode	NO
Broadcast command	NO		

*Support communications between HMI and PLC in pass-through mode

*Set LW-9903 to 2 to enhance the speed of download/upload PLC program in pass-through mode

Device Address:

Bit/Word	Device type	Format	Range	Memo
B	SM	DDDD	0 ~ 2047	
B	X	HHHH	0 ~ 1fff	Input Relay
B	Y	HHHH	0 ~ 1fff	Output Relay
B	M	DDDDD	0 ~ 61439	Internal Relay
B	L	DDDDD	0 ~ 32767	Latch Relay
B	F	DDDDD	0 ~ 32767	Annunciator
B	V	DDDDD	0 ~ 32767	Edge Relay
B	B	HHHH	0 ~ 7fff	Link Relay
B	TC	DDDDD	0 ~ 23087	Timer Coil
B	SS	DDDDD	0 ~ 23087	Retentive Timer
B	SC	DDDDD	0 ~ 23087	Retentive Timer Coil
B	CS	DDDDD	0 ~ 23087	Counter Contact
B	CC	DDDDD	0 ~ 23087	Counter Coil

Bit/Word	Device type	Format	Range	Memo
B	SB	HHH	0 ~ 7ff	Special Link Relay
B	S	DDDD	0 ~ 8191	Step Relay
B	DX	HHHH	0 ~ 1fff	Direct Input
B	DY	HHHH	0 ~ 1fff	Direct Output
B	TS	DDDD	0 ~ 2047	Timer Contact
B	D_Bit	DDDDDDDDh	0 ~ 4212735f	
B	ZR_Bit	HHHHHh	0 ~ fe7fff	
B	ZR_Dec_Bit	DDDDDDDDh	0 ~ 1042431f	
W	W	HHHH	0 ~ 657f	Link Register
W	TN	DDDD	0 ~ 23087	Timer Current Value
W	SN	DDDD	0 ~ 23087	Retentive Timer
W	CN	DDDD	0 ~ 23087	Counter Current
W	R	FFDDDD	0 ~ 3132767	File Register (FF:File No.)
W	SW	HHH	0 ~ 7ff	Special Link Register
W	Z	DD	0 ~ 15	Index Register
W	ZR	HHHHH	0 ~ fe7ff	File Register
W	ZR_decimal_addr	DDDDDD	0 ~ 1042431	
W	D	DDDD	0 ~ 25983	Data Register

Wiring Diagram:

6P Mini-DIN: Q02 CPU port RS232 (Diagram 1 ~ Diagram 3)

The following is the view from the soldering point of a connector.

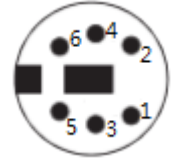


Diagram 1

cMT Series	cMT3151
eMT Series	eMT3070 / eMT3105 / eMT3120 / eMT3150
MT-iE	MT8073iE / MT8102iE
MT-XE	MT8092XE
MT-iP	MT6103iP

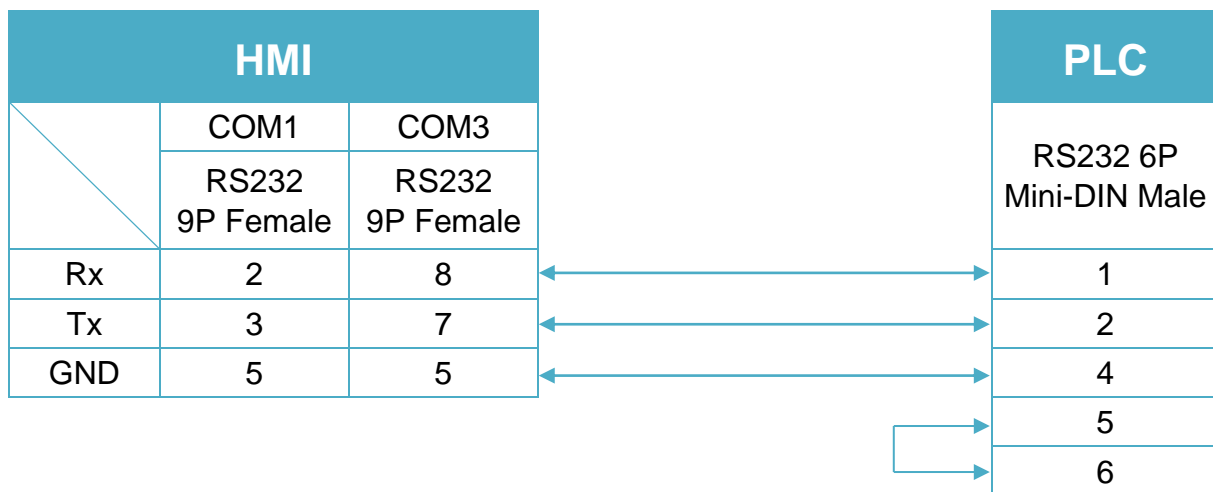


Diagram 2

cMT Series	cMT-SVR
mTV	mTV
MT-iE	MT8070iE / MT6070iE / MT8100iE / MT8121iE / MT8150iE / MT8071iE / MT6071iE / MT8072iE / MT6072iE / MT8073iE / MT8101iE / MT8102iE / MT8103iE
MT-XE	MT8121XE / MT8150XE / MT8090XE /

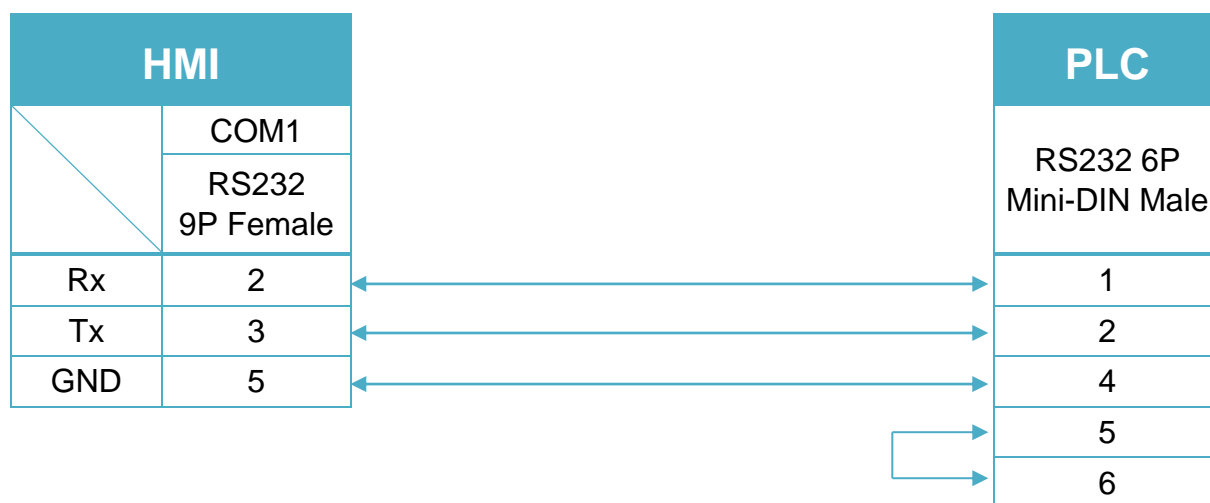
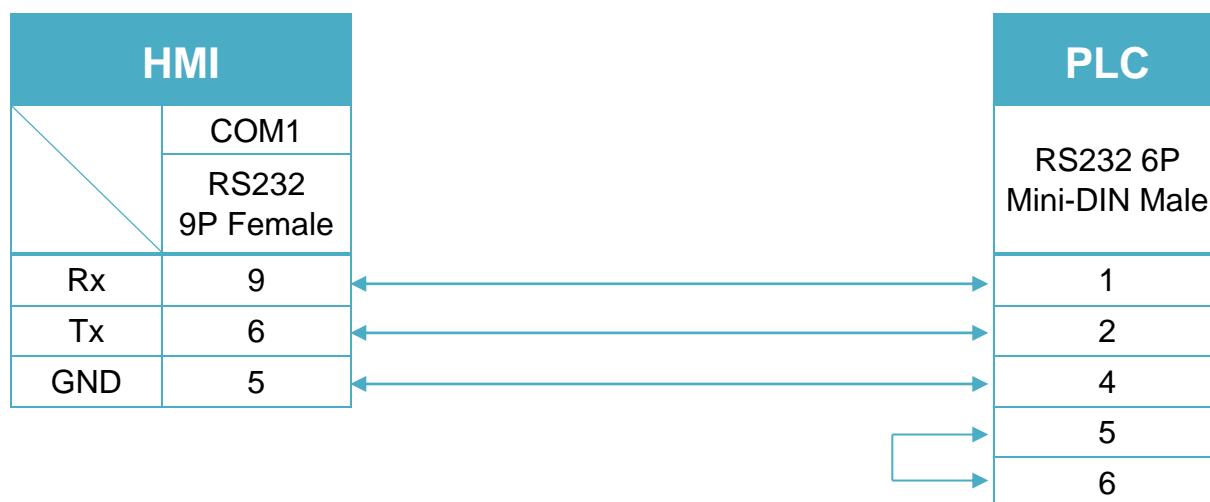


Diagram 3

MT-iE	MT8050iE
MT-iP	MT6051iP / MT6071iP / MT8071iP



Mitsubishi QJ71E71 (Ethernet)

Supported Series ; Mitsubishi Q type, MELSEC-Q series PLC (Q00J, Q00, Q01, Q02, Q02H, Q06H, Q12H, Q25H, Q12PH, Q25PH) QJ71E71-100 Ethernet module.

Website: <http://www.mitsubishi-automation.com>

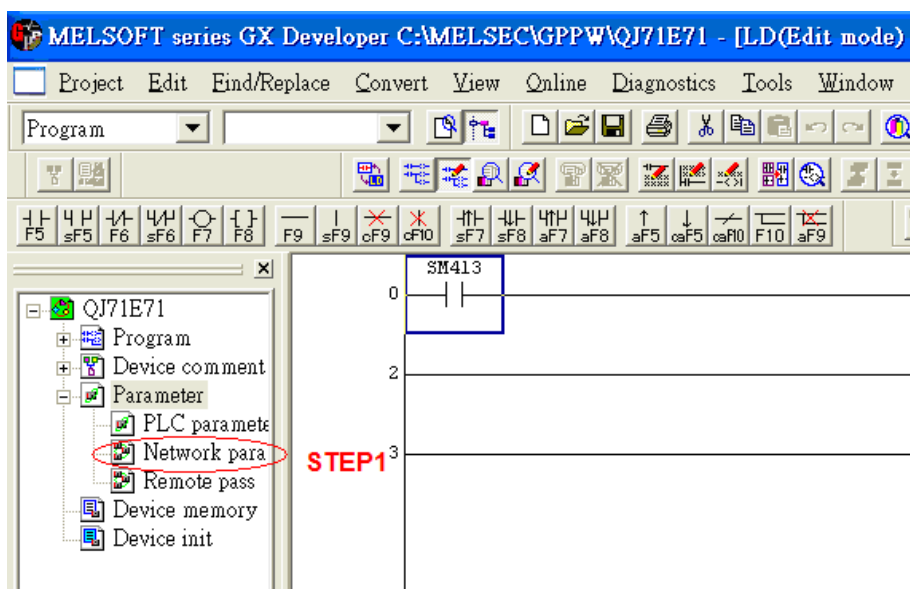
HMI Setting:

Parameters	Recommended	Options	Notes
PLC type	Mitsubishi QJ71E71 (Ethernet)		
PLC I/F	Ethernet		
Port no.	5002		
PLC sta. no.	2	1~99	
Network	1	1~999	

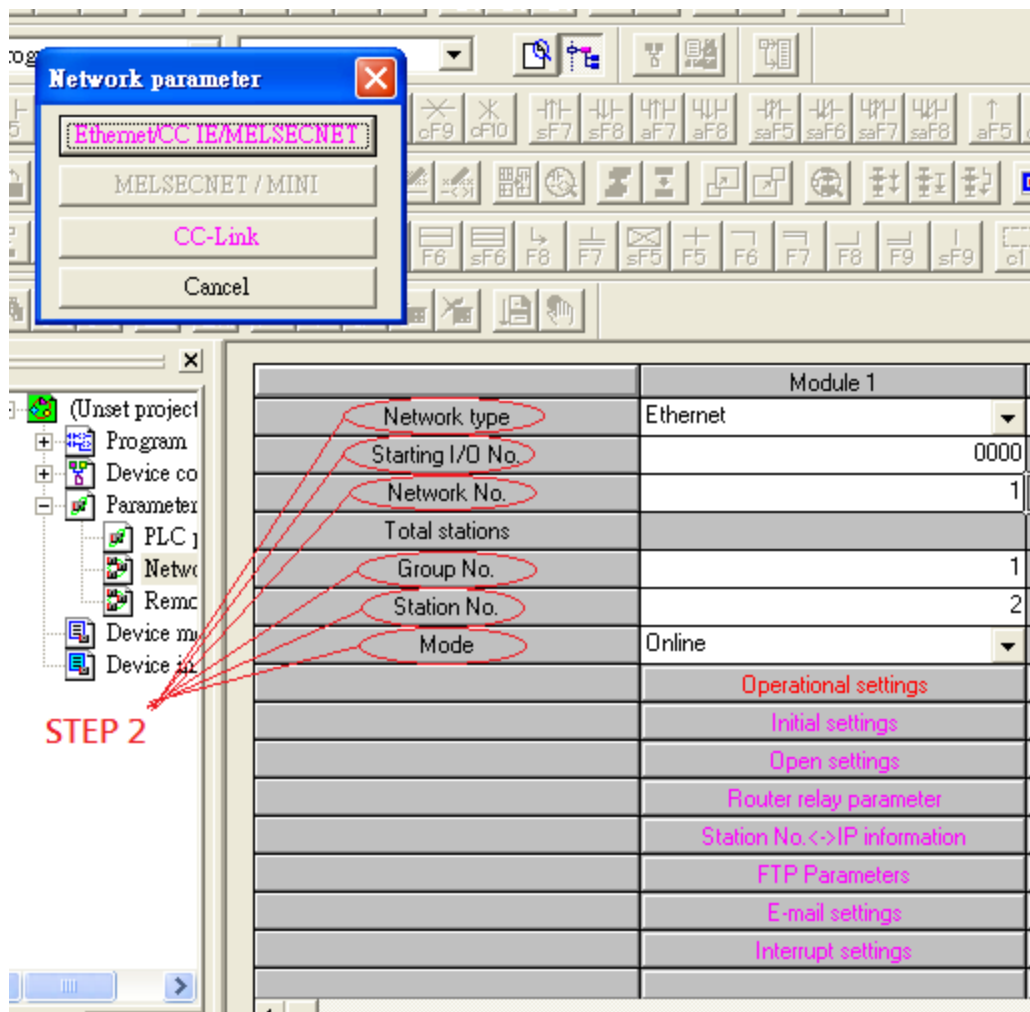
PLC Setting:

QJ71E71-100 Ethernet module settings:

1. Use USB or RS232 of Q-CPU for setting PLC parameters.



2. Click [Operational settings] to set IP information.



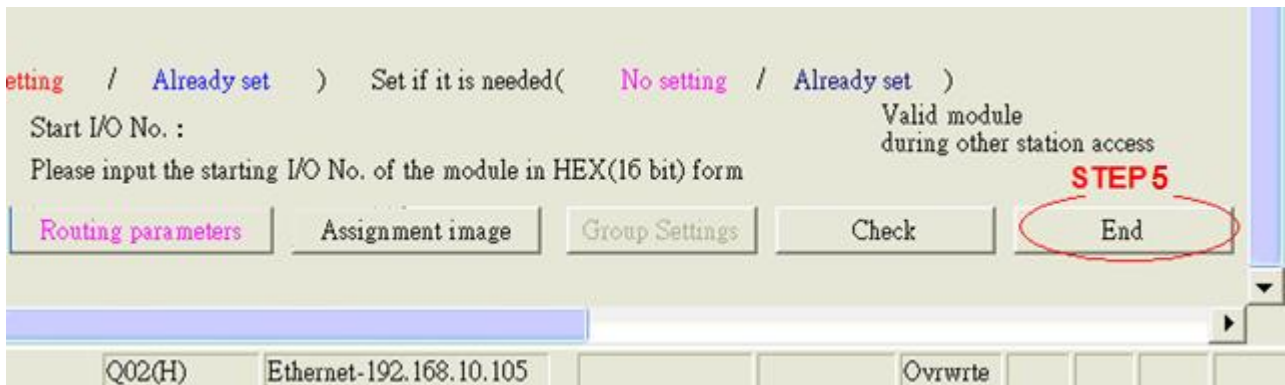
Module 1	
Network type	Ethernet
Starting I/O No.	0000
Network No.	1
Total stations	
Group No.	1
Station No.	2
Mode	Online
	Operational settings
	Initial settings
	Open settings
	Router relay parameter
	Station No.<->IP information
	FTP Parameters
	E-mail settings
	Interrupt settings

3. Select Ethernet (2.0) for communicating with HMI.

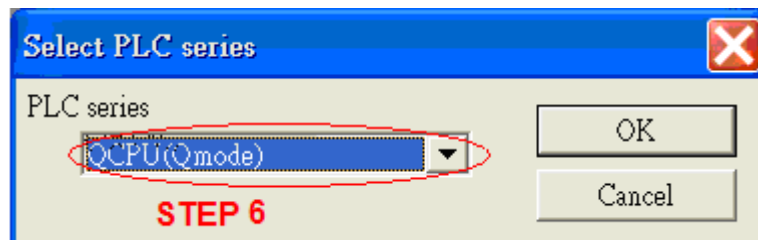
4. Click [Open settings] to set the system.

Module 1	
Network type	Ethernet
Starting I/O No.	0000
Network No.	1
Total stations	
Group No.	1
Station No.	2
Mode	Online
	Operational settings
	Initial settings
STEP 4	Open settings
	Router relay parameter
	Station No. <-> IP information
	FTP Parameters
	E-mail settings
	Interrupt settings

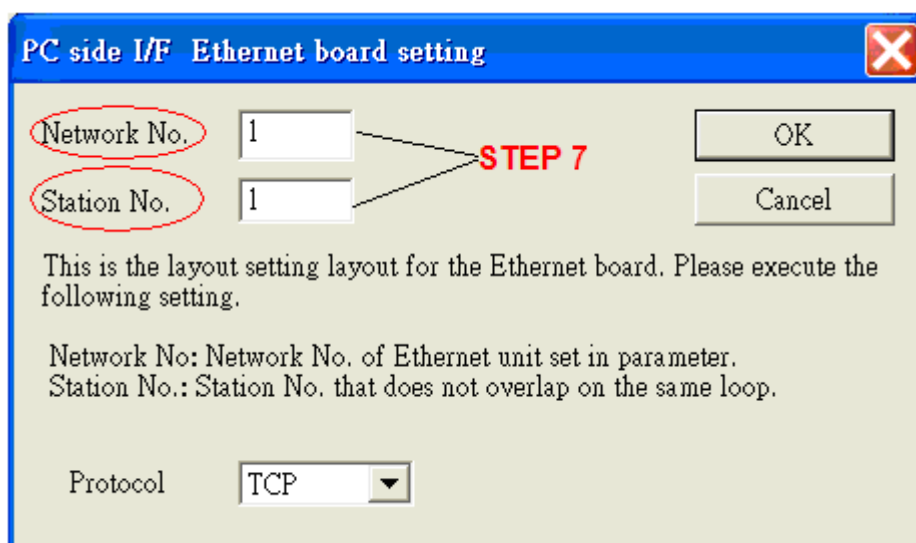
- Press [END] to finish settings.



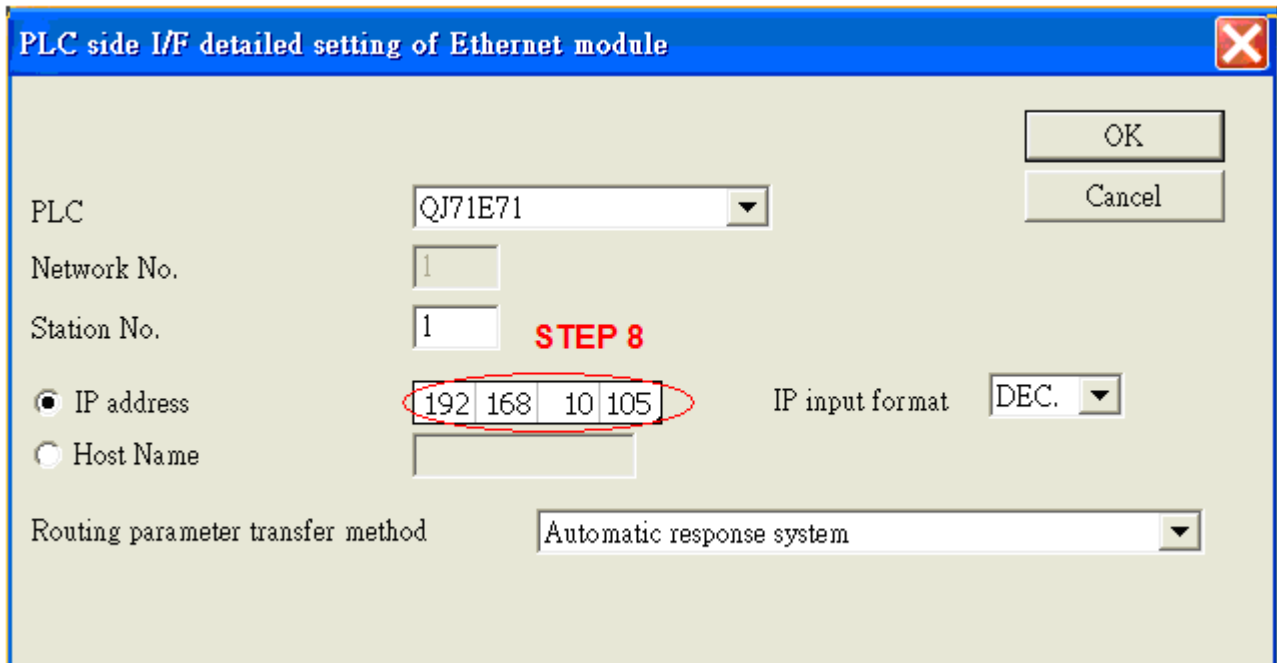
- Restart PLC software and select [READ FROM PLC], select [QCPU(Qmode)] and press [OK].



- In [PC side I/F Ethernet board setting] set Network No. and Station No. (Station No.1 is PC Station No. not Ethernet module Station No., ranged from 2~64, the Network No. can not be the same as that of PC)



8. Select "Ethernet module" in PLC Side I/F to set QJ71E71 IP address.(IP address = Network Parameter IP address)



PLC side I/F detailed setting of Ethernet module

PLC: QJ71E71

Network No.: 1

Station No.: 1

IP address: 192.168.10.105 (STEP 8)

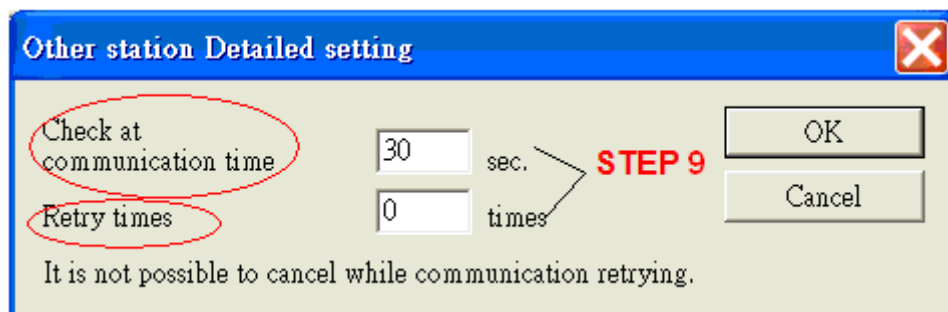
Host Name

IP input format: DEC.

Routing parameter transfer method: Automatic response system

OK, Cancel

9. For "Other station", click [Other station(Single network)] for setting [Check at communication time] and [Retry times].



Other station Detailed setting

Check at communication time: 30 sec. (STEP 9)

Retry times: 0 times

It is not possible to cancel while communication retrying.

OK, Cancel

10. After finishing the settings above, click [Connection test] for testing the communication and sending the PLC program.

Device Address:

Bit/Word	Device type	Format	Range	Memo
B	SM	N.DDDD	0 ~ 4.2047	
B	X	N.HHHH	0 ~ 4.1fff	Input Relay
B	Y	N.HHHH	0 ~ 4.1fff	Output Relay
B	M	N.DDDDD	0 ~ 4.61439	Internal Relay
B	L	N.DDDDD	0 ~ 4.32767	Latch Relay
B	F	N.DDDDD	0 ~ 4.32767	Annunciator
B	V	N.DDDDD	0 ~ 4.32767	Edge Relay
B	B	N.HHHH	0 ~ 4.1fff	Link Relay
B	TS	N.DDDD	0 ~ 4.2047	Timer Contact
B	TC	N.DDDD	0 ~ 4.2047	Timer Coil
B	SS	N.DDDDD	0 ~ 4.25471	Retentive Timer
B	SC	N.DDDDD	0 ~ 4.25471	Retentive Timer Coil
B	CS	N.DDDDD	0 ~ 4.25471	Counter Contact
B	CC	N.DDDDD	0 ~ 4.25471	Counter Coil
B	SB	N.HHH	0 ~ 4.7ff	Special Link Relay
B	S	N.DDDD	0 ~ 4.8191	Step Relay
B	DX	N.HHHH	0 ~ 4.1fff	Direct Input
B	DY	N.HHHH	0 ~ 4.1fff	Direct Output
B	D_Bit	N.DDDDDDDh	0 ~ 4.4212735f	
B	ZR_Bit	N.HHHHHh	0 ~ 4.fe7fff	
B	ZR_Dec_Bit	N.DDDDDDDh	0 ~ 4.1042431f	
W	SD	N.DDDD	0 ~ 4.2047	
W	D	N.DDDDDDD	0 ~ 4.4212735	Data Register
W	W	N.HHHH	0 ~ 4.1fff	Link Register
W	TN	N.DDDD	0 ~ 4.2047	Timer Current Value
W	SN	N.DDDD	0 ~ 4.2047	Retentive Timer Current
W	CN	N.DDDD	0 ~ 4.1023	Counter Current
W	SW	N.HHH	0 ~ 4.7ff	Special Link Register
W	Z	N.DD	0 ~ 4.15	Index Register
W	R	N.FFFDDDD	0 ~ 4.3132767	File Register (FF:File No. 0~31) (DDDD:0~32767)
W	ZR	N.HHHHH	0 ~ 4.fe7ff	File Register
W	ZR_decimal_addr	N.DDDDDDD	0 ~ 4.1042341	

Note: N=CPU Slot no. (0~4)

Wiring Diagram:

Ethernet cable:



Mitsubishi R04 (Ethernet)

Supported Series : Mitsubishi R04/R08 CPU Ethernet Module

Website: <http://www.mitsubishi-automation.com>

HMI Setting:

Parameters	Recommended	Options	Notes
PLC type	Mitsubishi R04 (Ethernet)		
PLC I/F	Ethernet		
Port no.	Set identically to the PLC setting		Advised to set port no. to 4999
PLC sta. no.	Set identically to the PLC setting		
Network number	0	0~999	
Communication data code	Binary	Binary / ASCII	

Device Address:

Bit/Word	Device type	Format	Range	Memo
B	X	HHHh	0 ~ 2ff	Input
B	Y	HHHh	0 ~ 2ff	Output
B	M	DDDDDDDD	0 ~ 16777215	Internal Relay
B	L	DDDDD	0 ~ 32767	Latch Relay
B	B	HHHHHHh	0 ~ fffffff	Link Relay
B	F	DDDDD	0 ~ 32767	Annunciator
B	SB	HHHHHHh	0 ~ fffffff	Link Special Relay
B	V	DDDDD	0 ~ 32767	Edge Relay
B	TS	DDDDDDDD	0 ~ 8993439	Timer Contact
B	TC	DDDDDDDD	0 ~ 8993439	Timer Coil
B	SS	DDDDDDDD	0 ~ 8993439	Retentive Timer
B	SC	DDDDDDDD	0 ~ 8993439	Retentive Timer Coil
B	CS	DDDDDDDD	0 ~ 8993439	Counter Contact
B	CC	DDDDDDDD	0 ~ 8993439	Counter Coil
B	SM	DDDD	0 ~ 4095	Special Relay
B	D_Bit	DDDDDDDDh	0 ~ 10117631f	Data Register
B	SD_Bit	DDDDh	0 ~ 4095f	Special Register
B	W_Bit	HHHHHHh	0 ~ 9a61fff	Link Register
B	SW_Bit	HHHHHHh	0 ~ 9a61fff	Link Special Register

Bit/Word	Device type	Format	Range	Memo
W	TN	DDDDDDDD	0 ~ 8993439	Timer Current Value
W	SN	DDDDDDDD	0 ~ 8993439	Retentive Timer Current
W	CN	DDDDDDDD	0 ~ 8993439	Counter Current Value
W	D	DDDDDDDD	0 ~ 10117631	Data Register
W	W	HHHHHH	0 ~ 9a61ff	Link Register
W	SW	HHHHHH	0 ~ 9a61ff	Special Link Register
W	SD	DDDD	0 ~ 4095	Special Register
W	Z	DD	0 ~ 23	Index Register

Wiring Diagram:

Ethernet cable:



MODBUS ASCII

Supported Series: MODBUS ASCII CONTROLLER

Website: <http://www.modbus.org>

HMI Setting:

Parameters	Recommended	Options	Notes
PLC type	MODBUS ASCII		
PLC I/F	RS485	RS232/RS485	
Baud rate	9600	9600/19200/38400/ 57600/115200	
Data bits	8	7,8	
Parity	Even	Even, Odd, None	
Stop bits	1	1,2	
PLC sta. no.	1	0-255	

Online simulator	YES	Broadcast command	YES
Extend address mode	YES		

PLC Setting:

Communication mode	Modbus ASCII protocol
---------------------------	-----------------------

Device Address:

Bit/Word	Device type	Format	Range	Memo
B	1x	DDDDD	1 ~ 65535	Input bit (read only)
B	0x	DDDDD	1 ~ 65535	Output bit
B	3x_Bit	DDDDDdd	100 ~ 6553515	Input Register bit (read only)
B	4x_Bit	DDDDDdd	100 ~ 6553515	Output Register bit
W	3x	DDDDD	1 ~ 65535	Input Register (read only)
W	4x	DDDDD	1 ~ 65535	Output Register
W	6x	DDDDD	1 ~ 65535	

Modbus RTU function code:

0x	0x01	Read coil	0x05	write single coil
1x	0x02	Read discrete input		N/A for write operation
3x	0x04	Read input register		N/A for write operation
4x	0x03	Read holding register	0x10	write multiple registers

3xbit is equivalent to 3x

4xbit is equivalent to 4x

Wiring Diagram:

RS232 (Diagram 1 ~ Diagram 3)

Diagram 1

cMT Series	cMT3151
eMT Series	eMT3070 / eMT3105 / eMT3120 / eMT3150
MT-iE	MT8073iE / MT8102iE
MT-XE	MT8092XE
MT-iP	MT6103iP

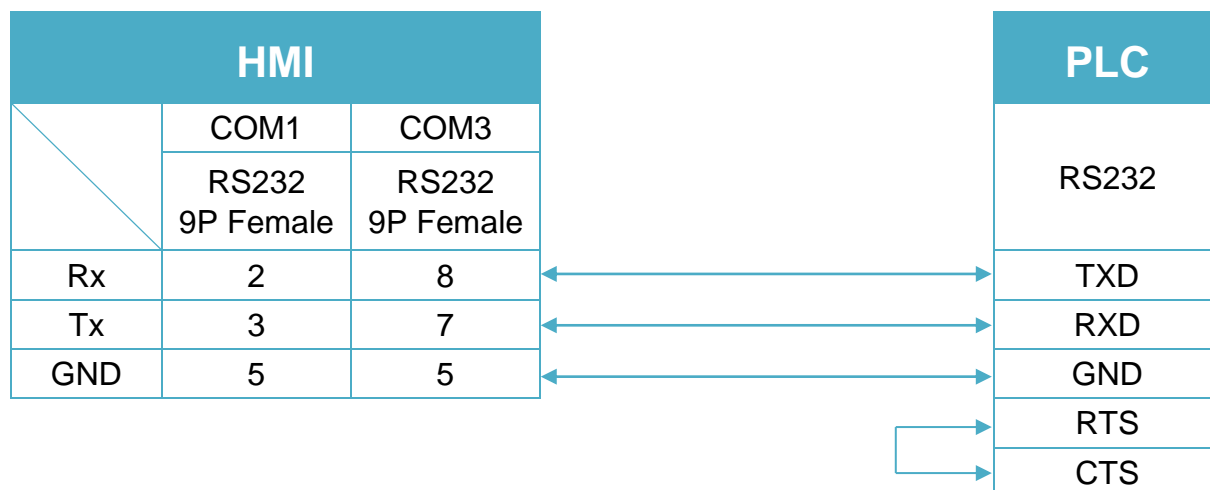


Diagram 2

cMT Series	cMT-SVR
mTV	mTV
MT-iE	MT8070iE / MT6070iE / MT8100iE / MT8121iE / MT8150iE / MT8071iE / MT6071iE / MT8072iE / MT6072iE / MT8073iE / MT8101iE / MT8102iE / MT8103iE
MT-XE	MT8121XE / MT8150XE / MT8090XE /

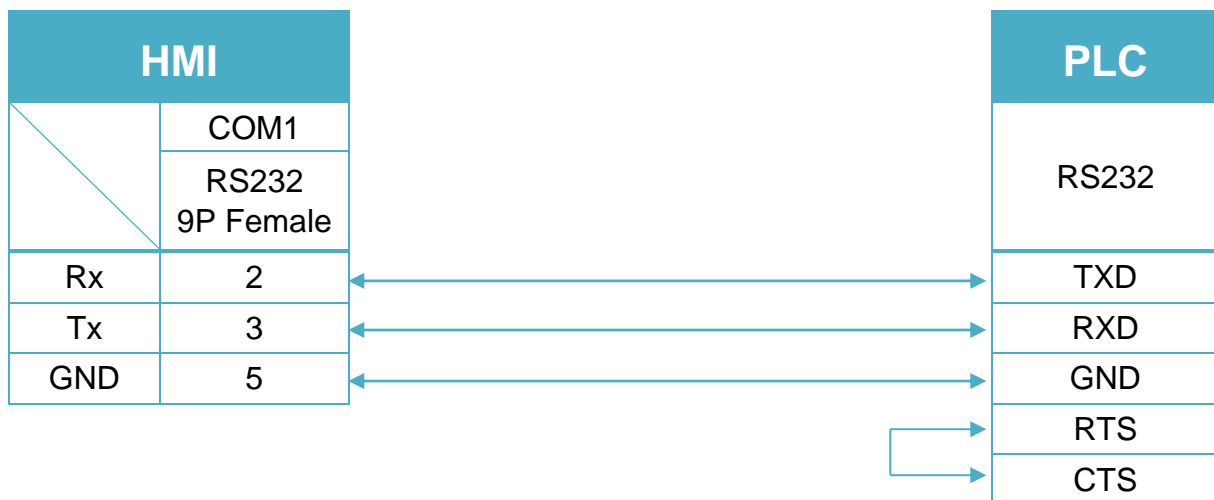
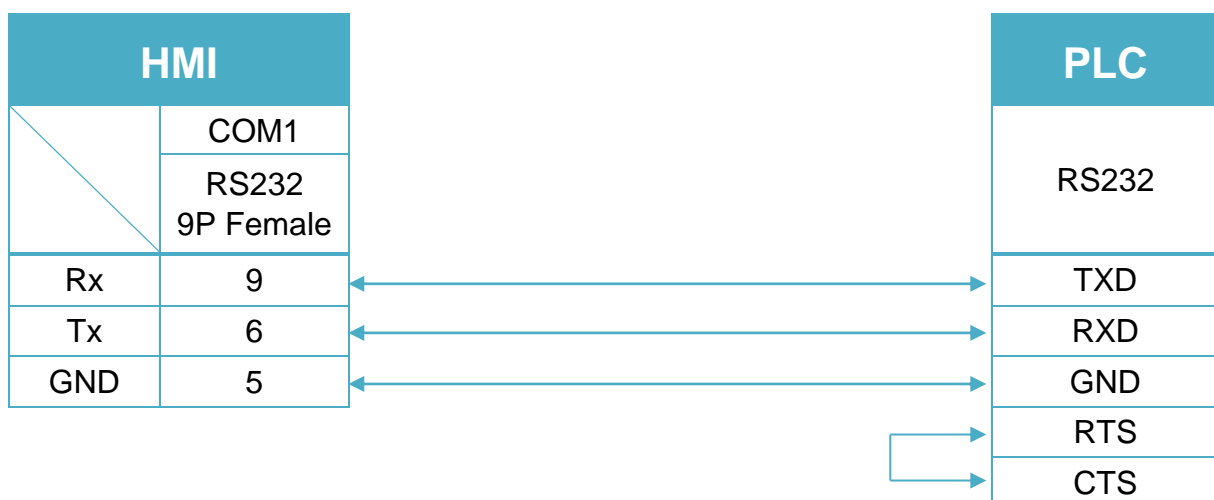


Diagram 3

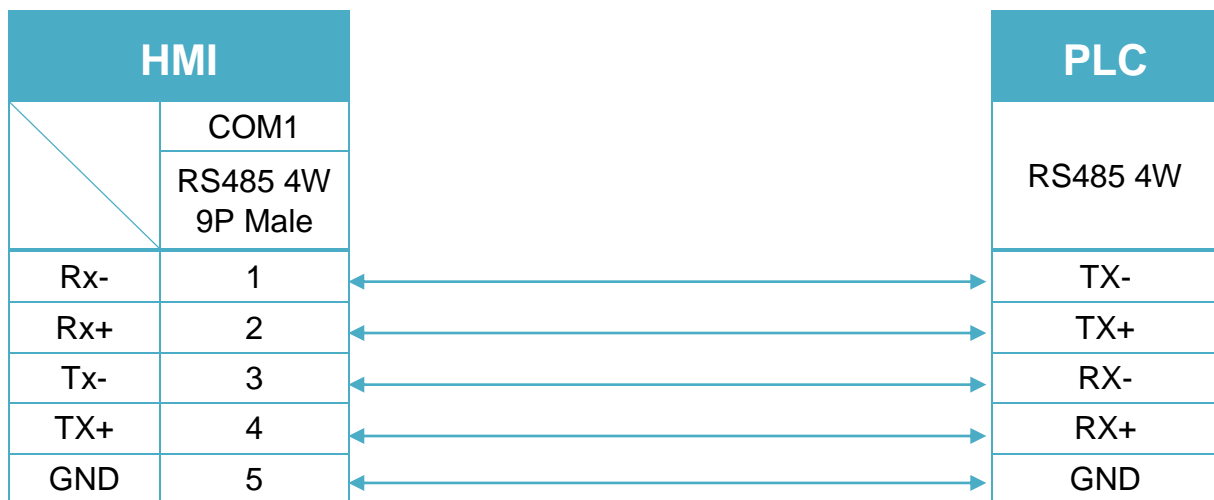
MT-iE	MT8050iE
MT-iP	MT6051iP / MT6071iP / MT8071iP



RS485 4W (Diagram 4 ~ Diagram 7)

Diagram 4

cMT Series	<i>cMT3151</i>
eMT Series	<i>eMT3070 / eMT3105 / eMT3120 / eMT3150</i>
MT-iE	<i>MT8070iE / MT6070iE / MT8100iE / MT8121iE / MT8150iE</i>
MT-XE	<i>MT8121XE / MT8150XE</i>


Diagram 5

cMT Series	<i>cMT-SVR</i>
mTV	<i>mTV</i>

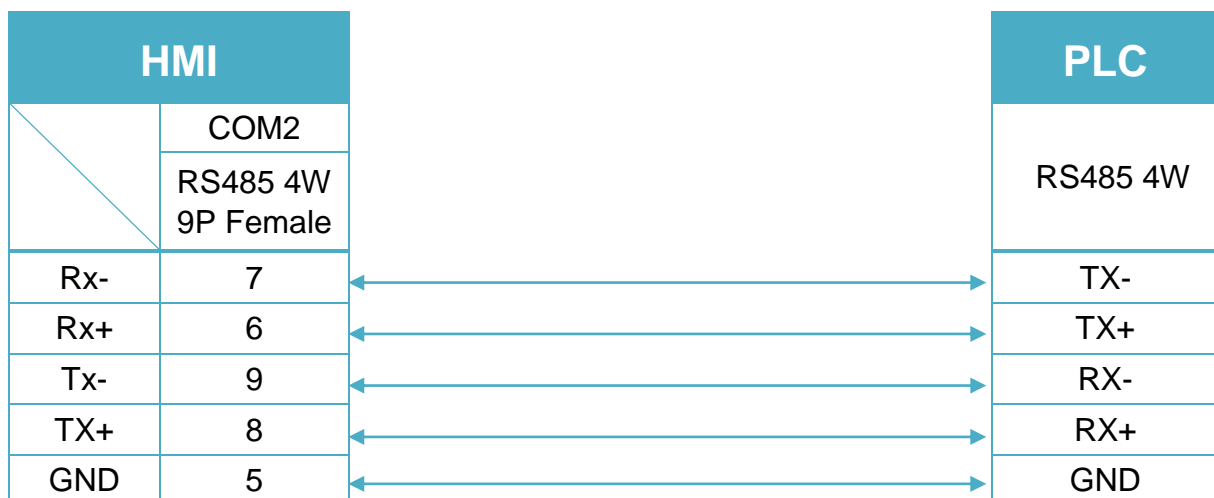


Diagram 6

MT-iE	<i>MT8071iE / MT6071iE / MT8072iE / MT6072iE / MT8073iE / MT8101iE / MT8102iE / MT8103iE</i>
MT-XE	<i>MT8090XE / MT8092XE</i>
MT-iP	<i>MT6071iP / MT8071iP / MT6103iP</i>

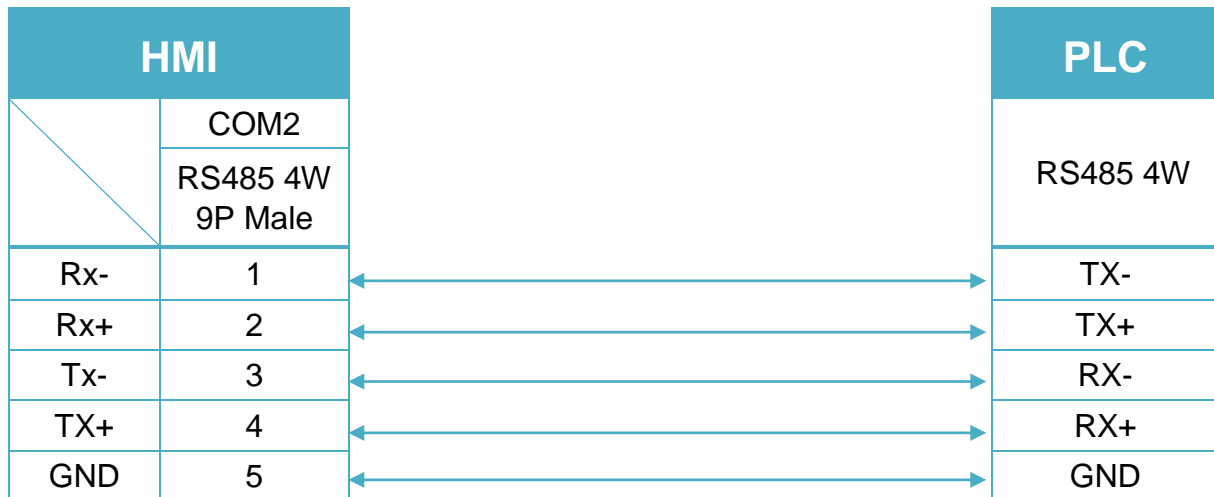
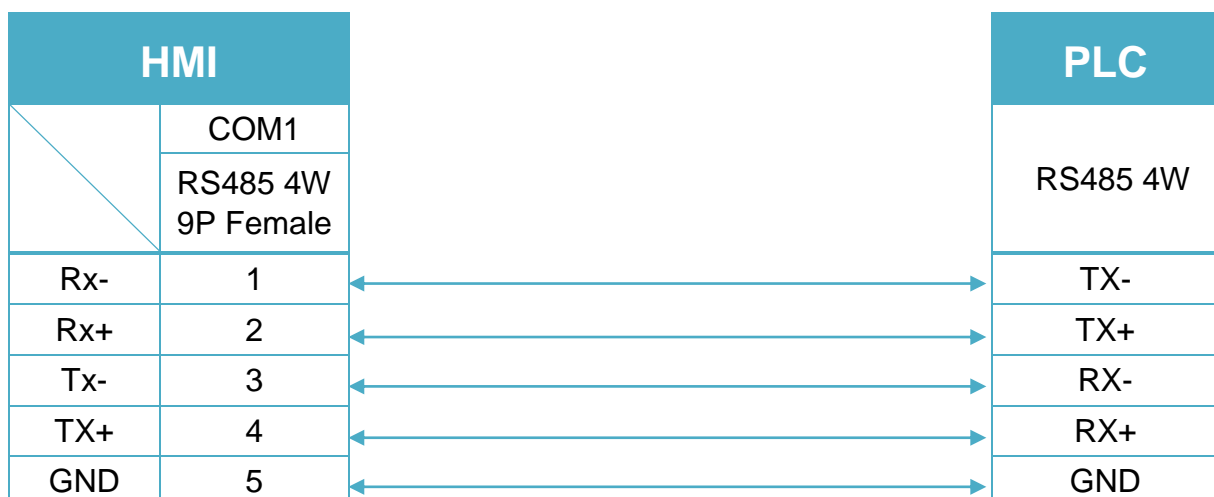


Diagram 7

MT-iE	<i>MT8050iE</i>
MT-iP	<i>MT6051iP</i>



RS485 2W (Diagram 8 ~ Diagram 13)

Diagram 8

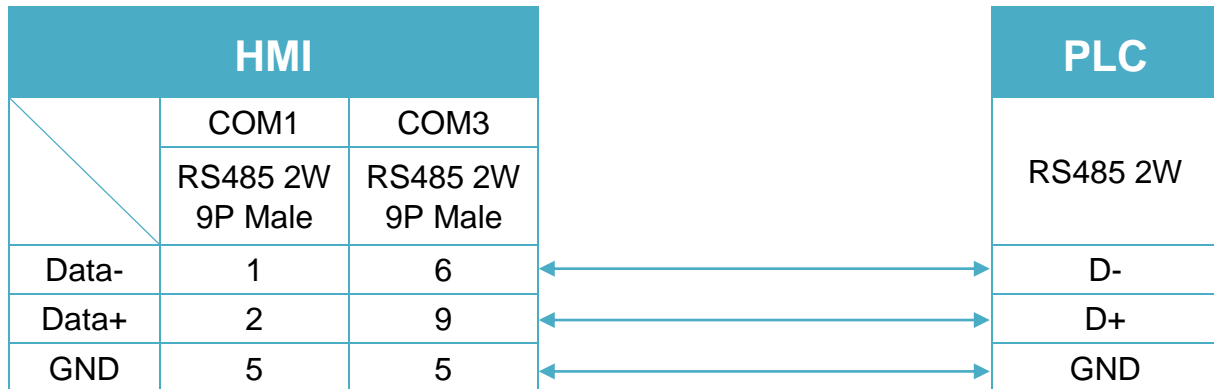
cMT Series
cMT3151
eMT Series
eMT3070 / eMT3105 / eMT3120 / eMT3150


Diagram 9

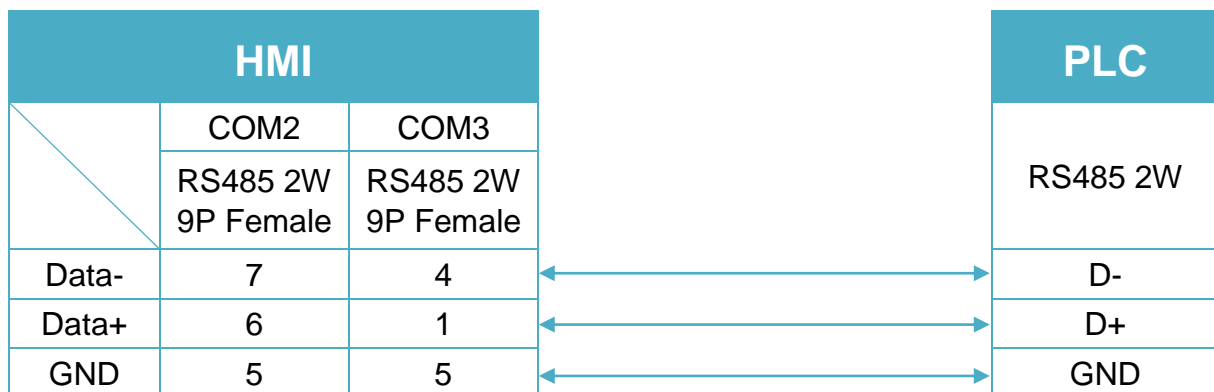
cMT Series
cMT-SVR
mTV
mTV


Diagram 10

MT-iE *MT8070iE / MT6070iE / MT8100iE / MT8121iE / MT8150iE*

MT-XE *MT8121XE / MT8150XE*

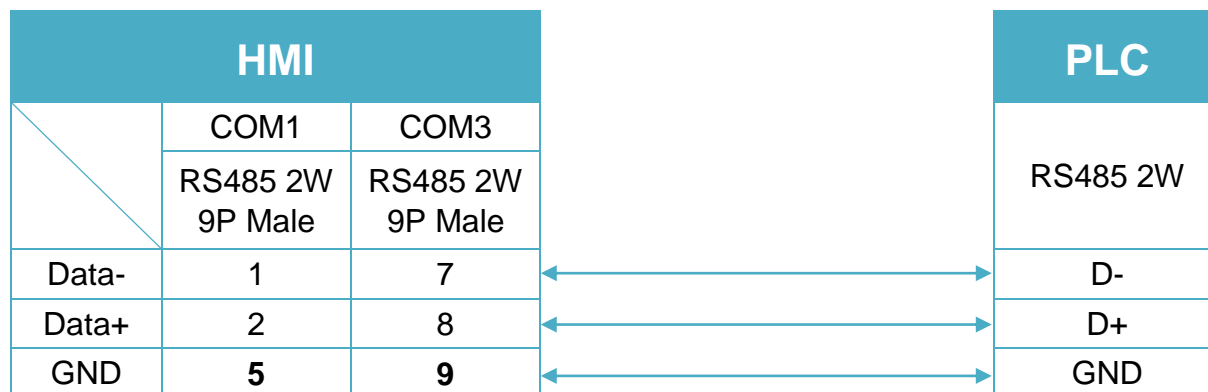


Diagram 11

MT-iE *MT8071iE / MT6071iE / MT8072iE / MT6072iE / MT8073iE /
MT8101iE / MT8102iE / MT8103iE*

MT-XE *MT8090XE / MT8092XE*

MT-iP *MT6103iP*

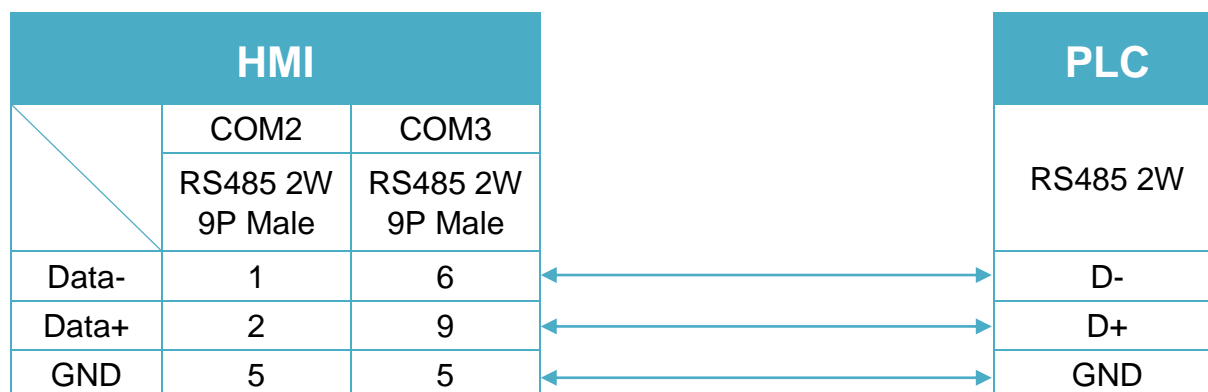


Diagram 12

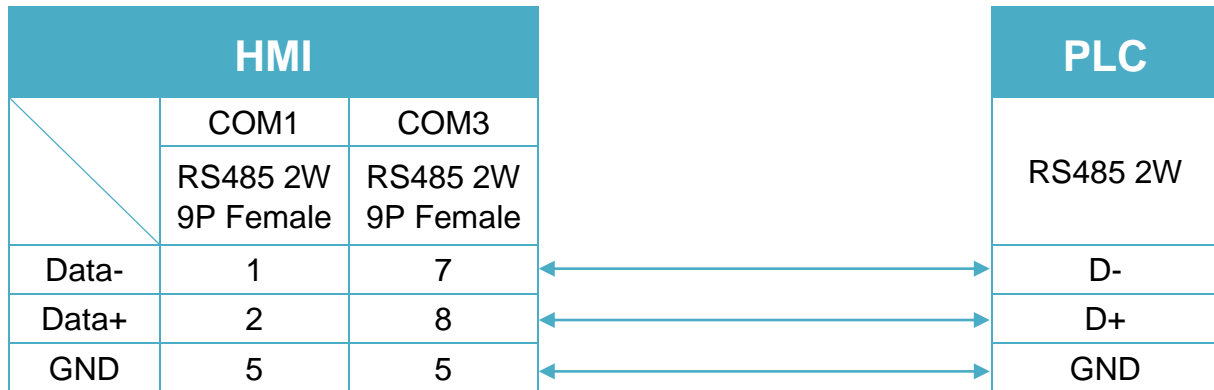
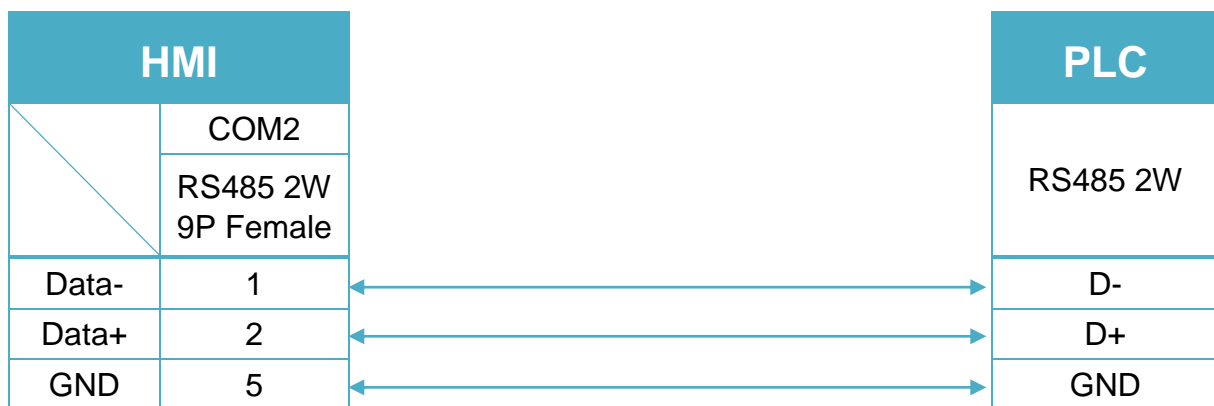
MT-iE *MT8050iE*
MT-iP *MT6051iP*


Diagram 13

MT-iP *MT6071iP / MT8071iP*


MODBUS ASCII Server

HMI Setting:

Parameters	Recommended	Options	Notes
PLC type	MODBUS ASCII Server		
PLC I/F	RS232	RS232, RS485	
Baud rate	9600	9600~115200	
Data bits	8	7,8	
Parity	Even	Even, Odd, None	
Stop bits	1	1	
PLC sta.	1	1-31	HMI Modbus Station No.

Online simulator	YES	Extend address mode	NO
Broadcast command	NO		

PLC Setting:

Communication mode	Modbus ASCII protocol
--------------------	-----------------------

Device Address:

Bit/Word	Device type	Format	Range	Memo
B	LB	dddd	0 ~ 9998	Mapping to 0x/1x 1 ~ 9999
W	LW	dddd	0 ~ 9998	Mapping to 3x/4x 1 ~ 9999
W	RW	dddddd	0 ~ 55536	Mapping to 3x/4x 10000 ~ 65536

LB0 = 0x0001, LB1 = 0x0002, LW0 = 3x0001, LW1 = 3x0002

Modbus RTU Server doesn't support function code 06(preset single register), please use function code 16(0x10, preset multiple registers).

Modbus Server Function Code:

0x	0x01	Read coil	0x05	write single coil
0x_multi_coils	0x01	Read coil	0x0f	write multiple coils
1x	0x02	Read discrete input	N/A	for write operation
3x	0x04	Read input register	N/A	for write operation
4x	0x03	Read holding register	0x10	write multiple registers

Wiring Diagram:

RS232 (Diagram 1 ~ Diagram 3)

Diagram 1

cMT Series	<i>cMT3151</i>
eMT Series	<i>eMT3070 / eMT3105 / eMT3120 / eMT3150</i>
MT-iE	<i>MT8073iE / MT8102iE</i>
MT-XE	<i>MT8092XE</i>
MT-iP	<i>MT6103iP</i>

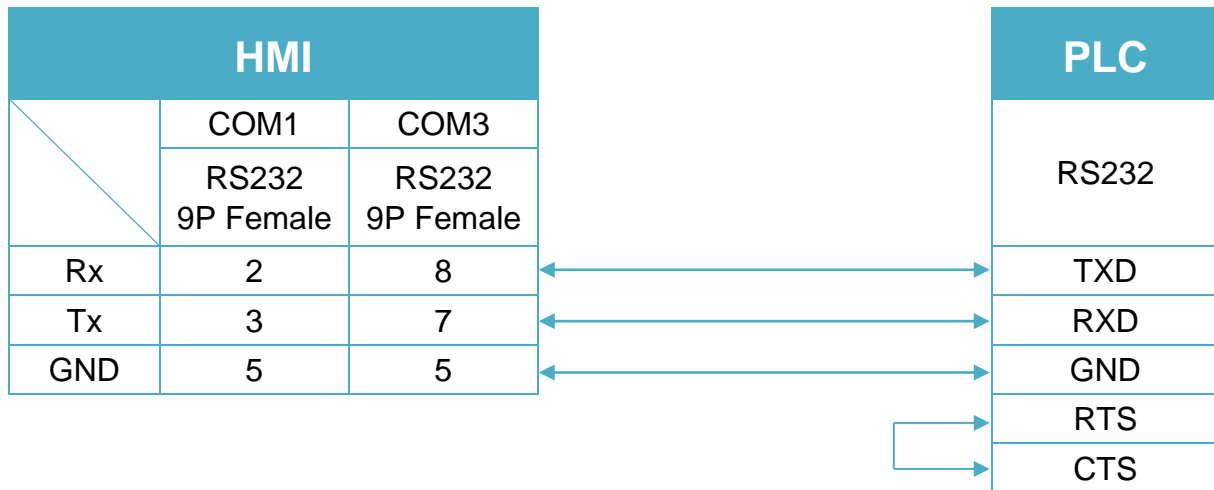


Diagram 2

cMT Series	cMT-SVR
mTV	mTV
MT-iE	MT8070iE / MT6070iE / MT8100iE / MT8121iE / MT8150iE / MT8071iE / MT6071iE / MT8072iE / MT6072iE / MT8073iE / MT8101iE / MT8102iE / MT8103iE
MT-XE	MT8121XE / MT8150XE / MT8090XE /

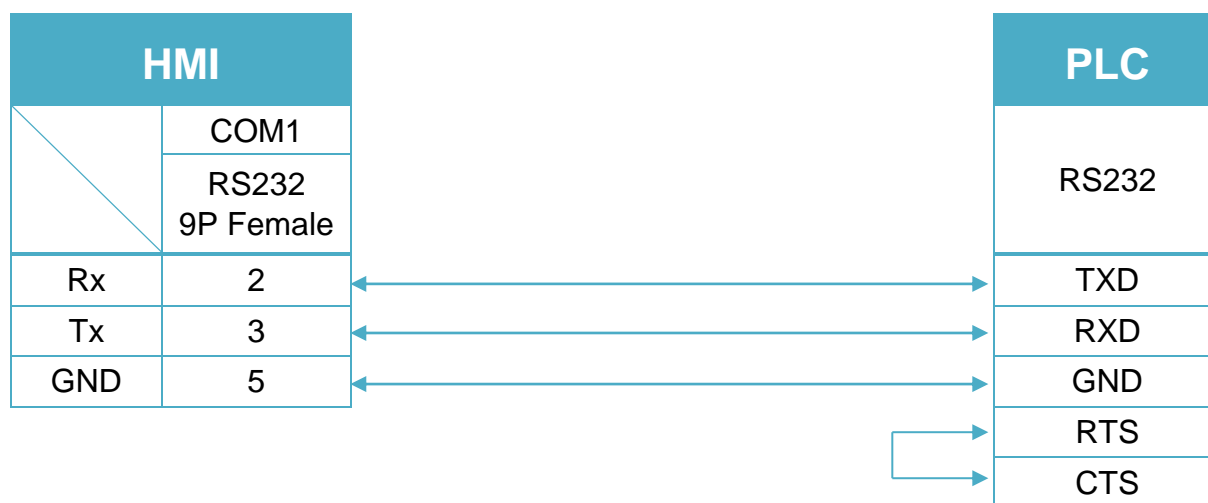
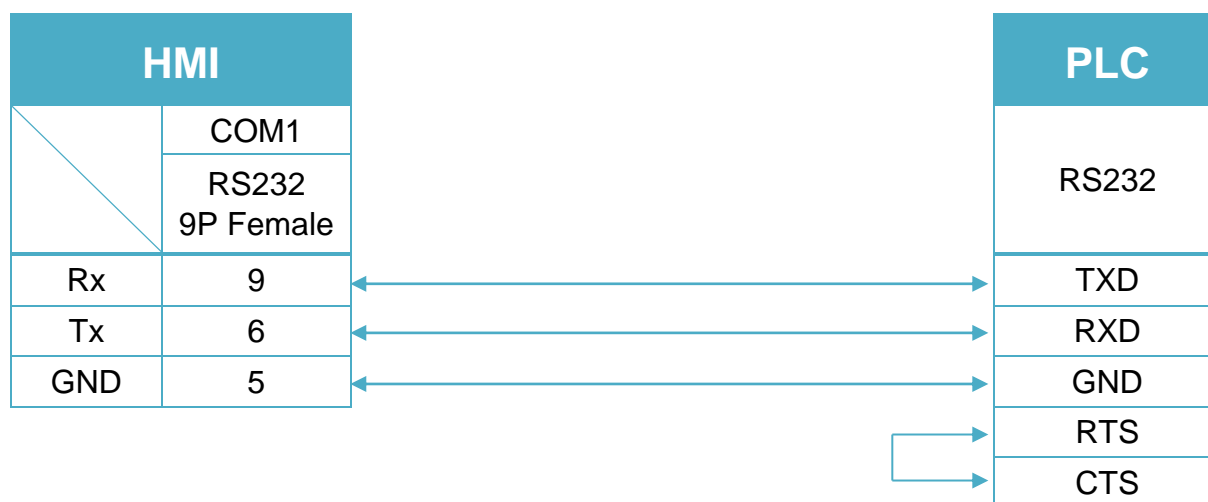


Diagram 3

MT-iE	MT8050iE
MT-iP	MT6051iP / MT6071iP / MT8071iP



RS485 4W (Diagram 4 ~ Diagram 7)

Diagram 4

cMT Series	<i>cMT3151</i>
eMT Series	<i>eMT3070 / eMT3105 / eMT3120 / eMT3150</i>
MT-iE	<i>MT8070iE / MT6070iE / MT8100iE / MT8121iE / MT8150iE</i>
MT-XE	<i>MT8121XE / MT8150XE</i>

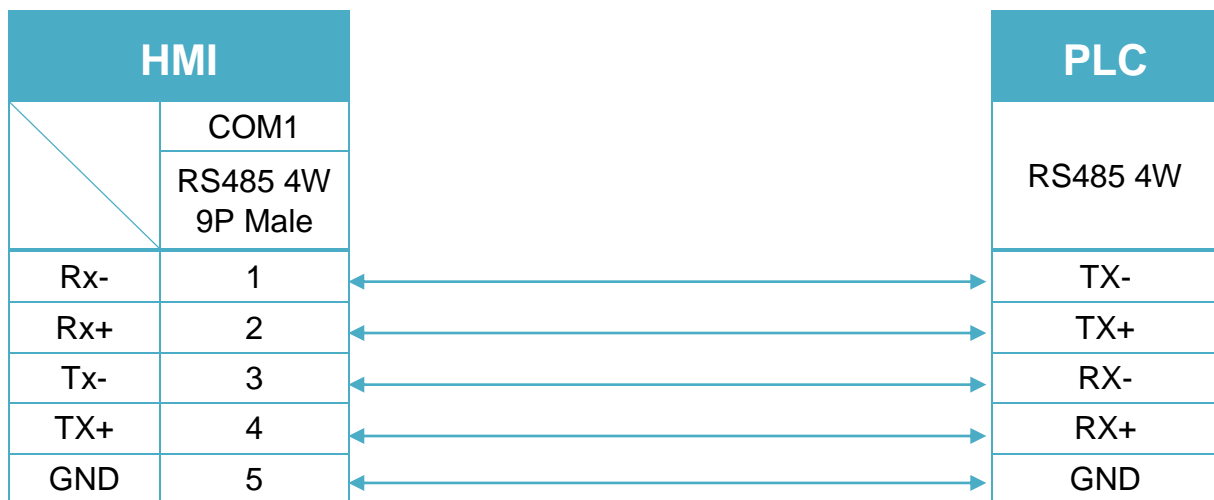


Diagram 5

cMT Series	<i>cMT-SVR</i>
mTV	<i>mTV</i>

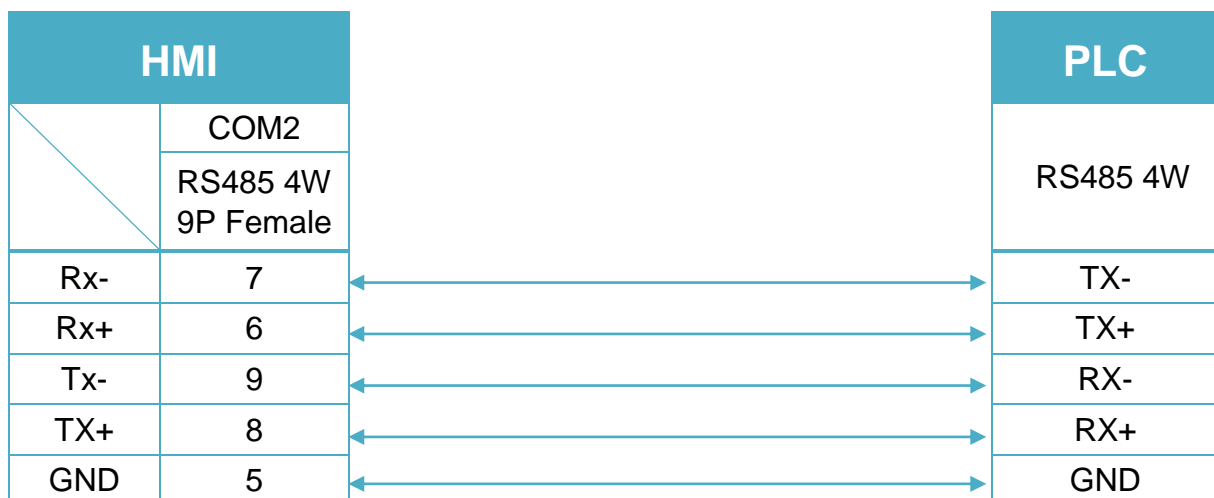


Diagram 6

MT-iE	<i>MT8071iE / MT6071iE / MT8072iE / MT6072iE / MT8073iE / MT8101iE / MT8102iE / MT8103iE</i>
MT-XE	<i>MT8090XE / MT8092XE</i>
MT-iP	<i>MT6071iP / MT8071iP / MT6103iP</i>

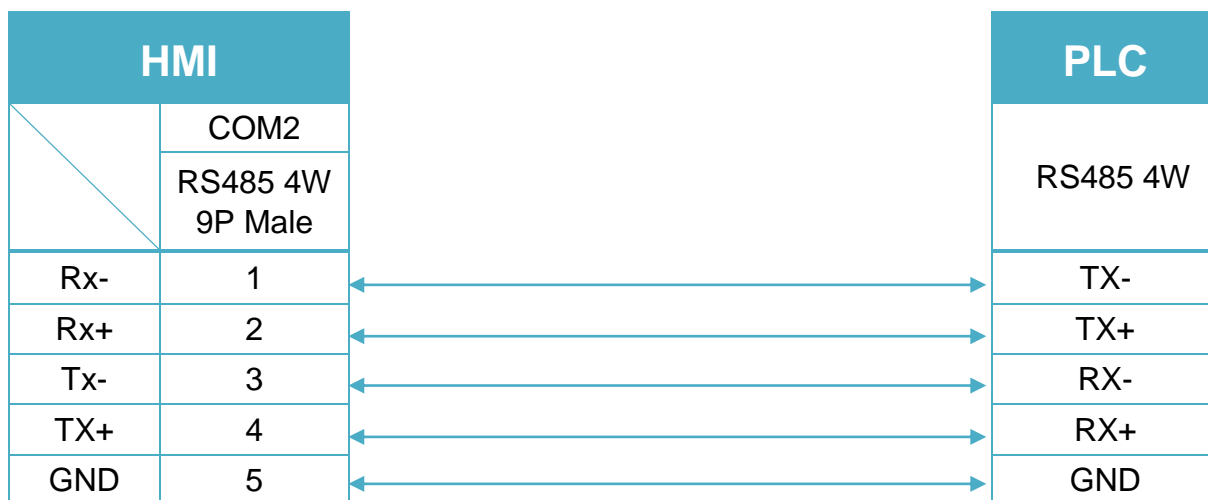
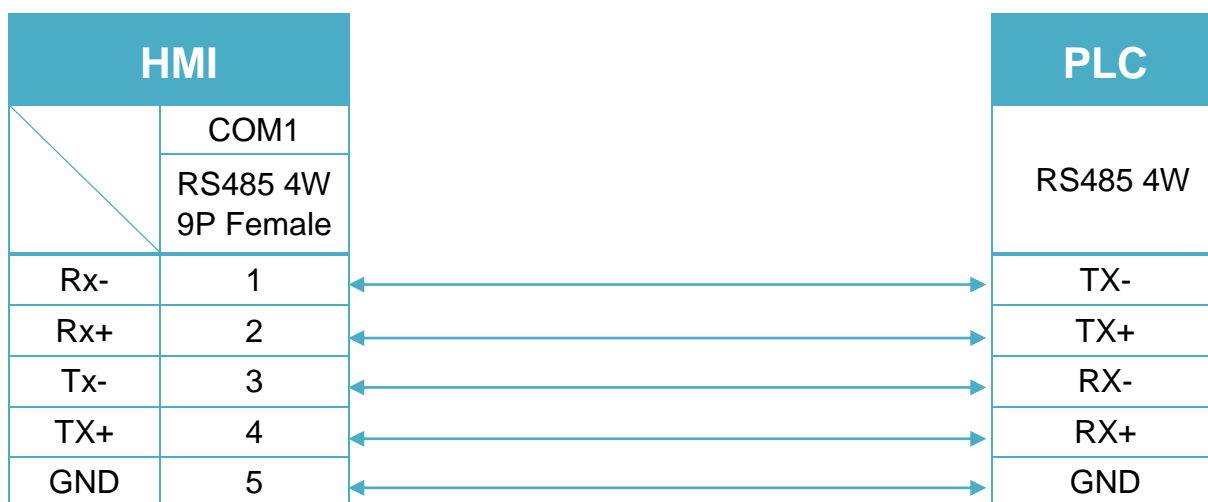


Diagram 7

MT-iE	<i>MT8050iE</i>
MT-iP	<i>MT6051iP</i>



RS485 2W (Diagram 8 ~ Diagram 13)

Diagram 8

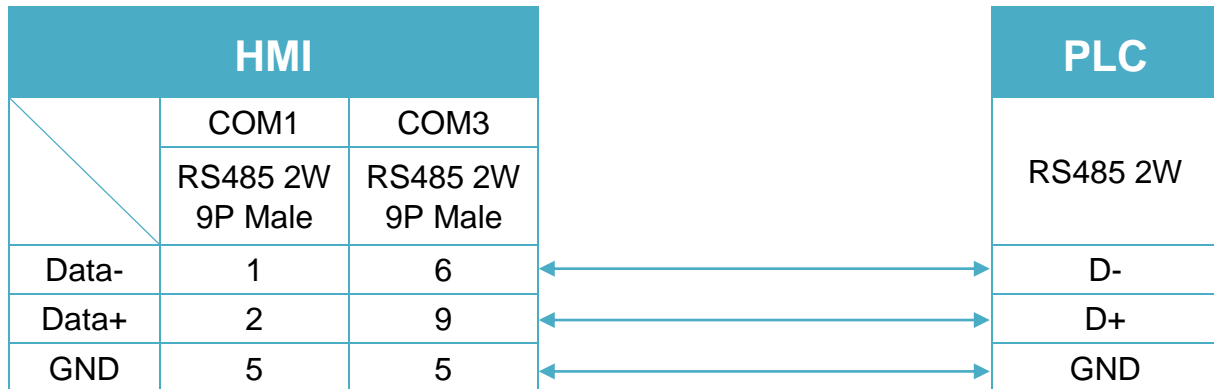
cMT Series
cMT3151
eMT Series
eMT3070 / eMT3105 / eMT3120 / eMT3150


Diagram 9

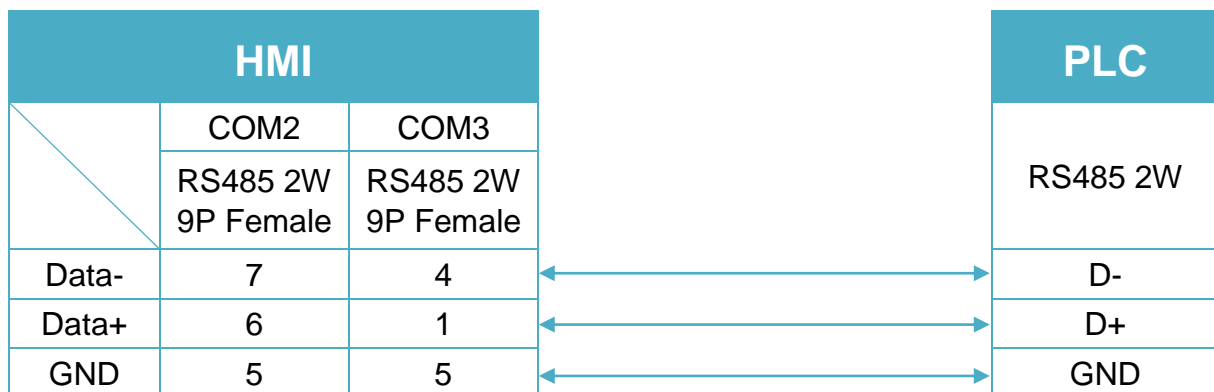
cMT Series
cMT-SVR
mTV
mTV


Diagram 10

MT-iE *MT8070iE / MT6070iE / MT8100iE / MT8121iE / MT8150iE*

MT-XE *MT8121XE / MT8150XE*

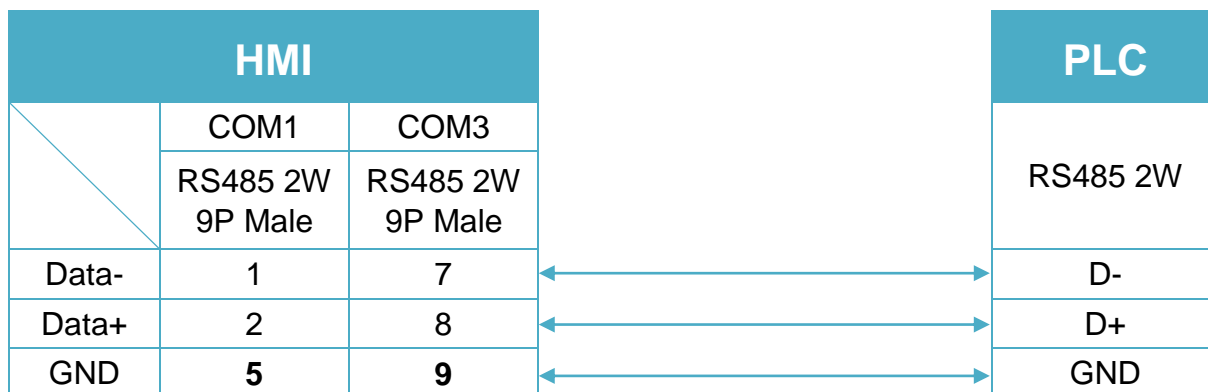


Diagram 11

MT-iE *MT8071iE / MT6071iE / MT8072iE / MT6072iE / MT8073iE /
MT8101iE / MT8102iE / MT8103iE*

MT-XE *MT8090XE / MT8092XE*

MT-iP *MT6103iP*

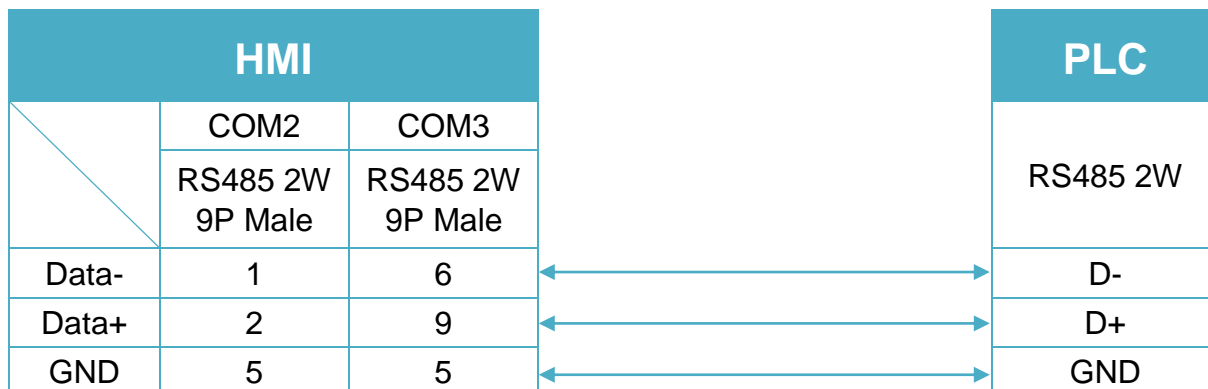


Diagram 12

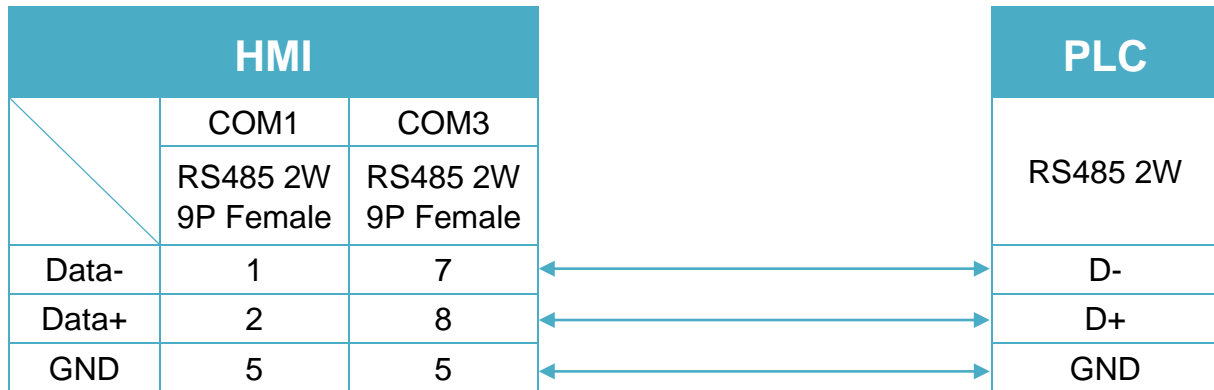
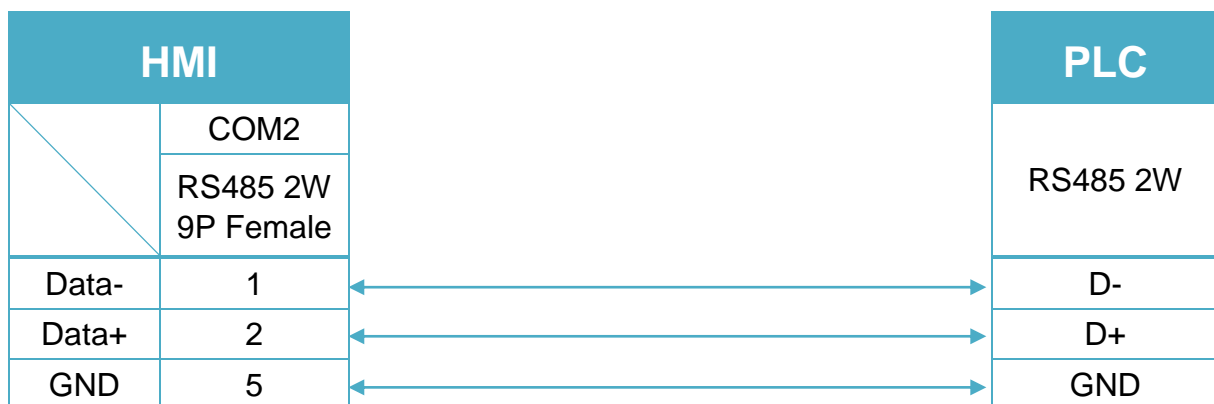
MT-iE *MT8050iE*
MT-iP *MT6051iP*


Diagram 13

MT-iP *MT6071iP / MT8071iP*


Note: Setting more than one Modbus ASCII Server in HMI Device List is of no effect.

MODBUS RTU

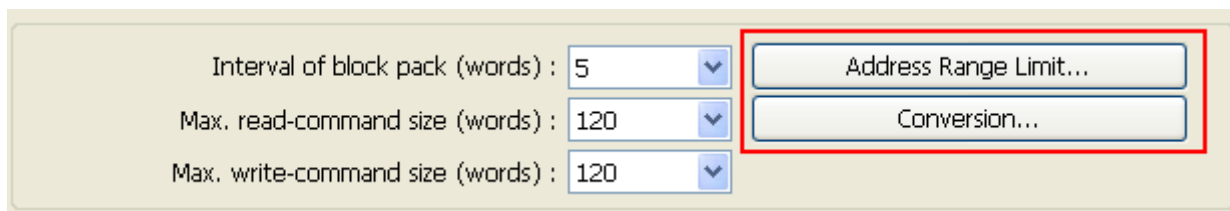
Supported Series : MODBUS RTU CONTROLLER

Website : <http://www.modbus.org>

HMI Setting:

Parameters	Recommended	Options	Notes
PLC type	MODBUS RTU		
PLC I/F	RS485	RS232/RS485/USB	
Baud rate	9600	9600~115200	
Data bits	8	7, 8	
Parity	Even	Even, Odd, None	
Stop bits	1	1, 2	
PLC sta. no.	1	0-255	

Online simulator	YES	Broadcast command	YES
Extend address mode	YES		



Interval of block pack (words) : 5

Max. read-command size (words) : 120

Max. write-command size (words) : 120

Address Range Limit...

Conversion...

[Address Range Limit]

The address range of 0x, 1x, and 0x_multi_coils device types can be set.

[Conversion]

The 3x_Double and 4x_Double address types are added. If [ABCD ->CDAB] check box is selected, please select 3x_Double and 4x_Double address types.

PLC Setting:

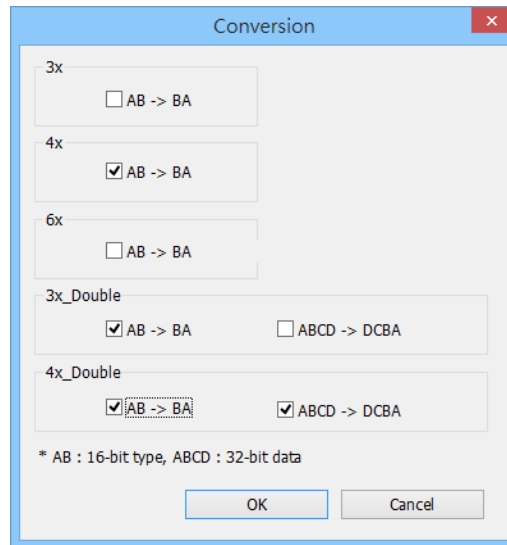
Communication mode	Modbus RTU protocol
--------------------	---------------------

Device Address:

Bit/Word	Device type	Format	Range	Memo
B	0x	DDDDD	1 ~ 65535	Output bit
B	0x_single_bit	DDDDD	1 ~ 65535	*Note4
B	1x_single_bit	DDDDD	1 ~ 65535	*Note4
B	1x	DDDDD	1 ~ 65535	Input bit (read only)
B	3x_Bit	DDDDDdd	100 ~ 6553515	Input Register bit (read only)
B	4x_Bit	DDDDDdd	100 ~ 6553515	Output Register bit
B	6x_Bit	DDDDDdd	100 ~ 6553515	Output Register bit
B	0x_multi_coils	DDDDD	1 ~ 65535	Write multiple coils
W	3x	DDDDD	1 ~ 65535	Input Register (read only)
W	3x_MAX1W	DDDDD	1 ~ 65535	Display 32 bits *Note1
DW	3x_MAX2W	DDDDD	1 ~ 65535	*Note1
W	4x	DDDDD	1 ~ 65535	Output Register
W	4x_MAX1W	DDDDD	1 ~ 65535	Display 32 bits *Note1
DW	4x_MAX2W	DDDDD	1 ~ 65535	*Note1
DW	5x	DDDDD	1 ~ 65535	4x double word swap *Note5
W	6x	DDDDD	1 ~ 65535	4x single word write
W	3x_Double	DDDDD	1 ~ 65535	*Note2
W	4x_Double	DDDDD	1 ~ 65535	*Note2
W	4x_32Bit	DDDDD	1 ~ 65535	Output Registerv *Note1
W	0x_single_coil	DDDDD	1 ~ 65535	*Note3

Note1: MAX1W and 4X_32Bit reads/writes 1 word for each packet and displays a 32-bit value, whereas MAX2W reads/writes 2 words for each packet.

Note2: Go the [System Parameter Settings] -> [Device Properties] and click [Conversion] to set the data format of device types 3x, 4x, 6x, 3x_double, 4x double.



Note3: Read/write a Bit at a time. Value 0 and 1 are used to represent ON or OFF status where 0 means set OFF and 1 means set ON.

Note4: The number of bits to read can be set in Macro; therefore, it is recommended to use 0x address type for functions such as GetData() and SetData(), in order to increase reading speed.

To read/write multiple 0x address type in macro, use 0x_multi_coils to increase write speed.

Note5: Please assign all the addresses to Even addresses, or all to Odd addresses, in order to prevent communication failure.

NOTE:

Address type “5x” is mapped to Holding Register. The communication protocol of 5x is almost the same as “4x” except that “5x” swaps double word.

If 4x contains the following information:

Address	1	2	3	4	5	6	...
Data in word	0x1	0x2	0x3	0x4	0x5	0x6	
Data	0x0201		0x0403		0x0605		

For 5x, it will be:

Address	1	2	3	4	5	6	...
Data in word	0x1	0x2	0x3	0x4	0x5	0x6	
Data	0x0102		0x0304		0x0506		

Modbus RTU function code:

0x	0x01	Read coil	0x05	write single coil
0x_multi_coils	0x01	Read coil	0x0f	write multiple coils
1x	0x02	Read discrete input	N/A	for write operation
3x	0x04	Read input register	N/A	for write operation
4x	0x03	Read holding register	0x10	write multiple registers
5x	0x03	Read holding register	0x10	write multiple registers

(Note: reverse word order in double word format)

3xbit is equivalent to 3x

4xbit is equivalent to 4x

6x	0x03	Read holding register	0x06	write single register
----	------	-----------------------	------	-----------------------

(Note: 6x is limited to device of one word only)

0x_single_coil	0x01	Read coil	0x05	write single coil
----------------	------	-----------	------	-------------------

Wiring Diagram:

RS232 (Diagram 1 ~ Diagram 3)

Diagram 1

cMT Series	cMT3151
eMT Series	eMT3070 / eMT3105 / eMT3120 / eMT3150
MT-iE	MT8073iE / MT8102iE
MT-XE	MT8092XE
MT-iP	MT6103iP

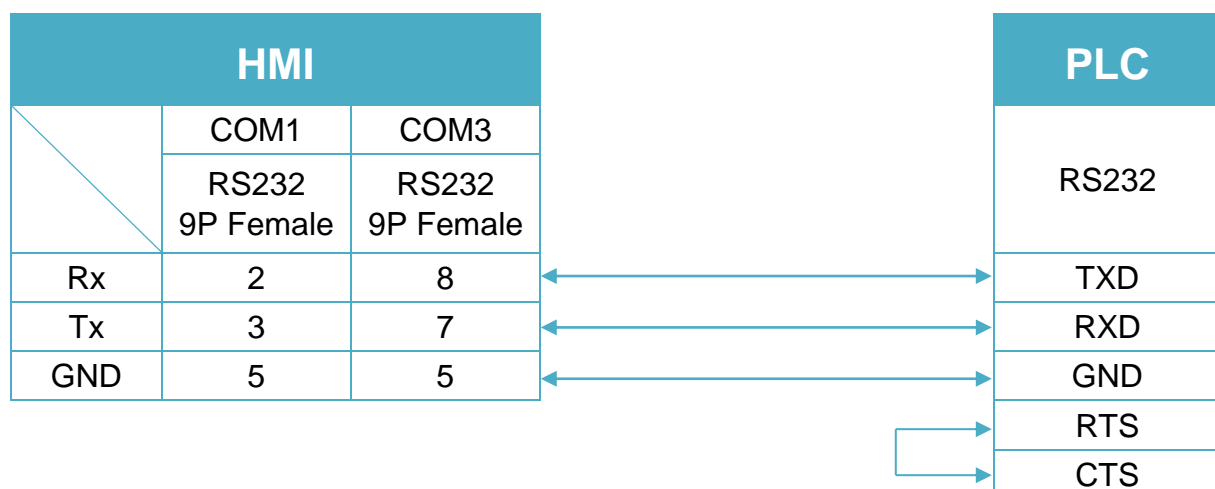


Diagram 2

cMT Series	cMT-SVR
mTV	mTV
MT-iE	MT8070iE / MT6070iE / MT8100iE / MT8121iE / MT8150iE / MT8071iE / MT6071iE / MT8072iE / MT6072iE / MT8073iE / MT8101iE / MT8102iE / MT8103iE
MT-XE	MT8121XE / MT8150XE / MT8090XE /

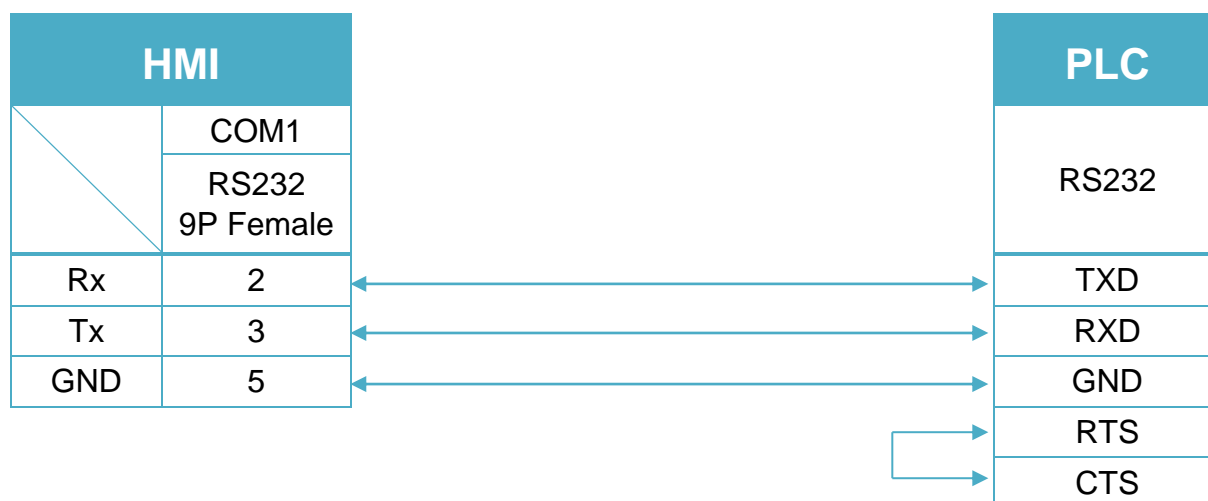
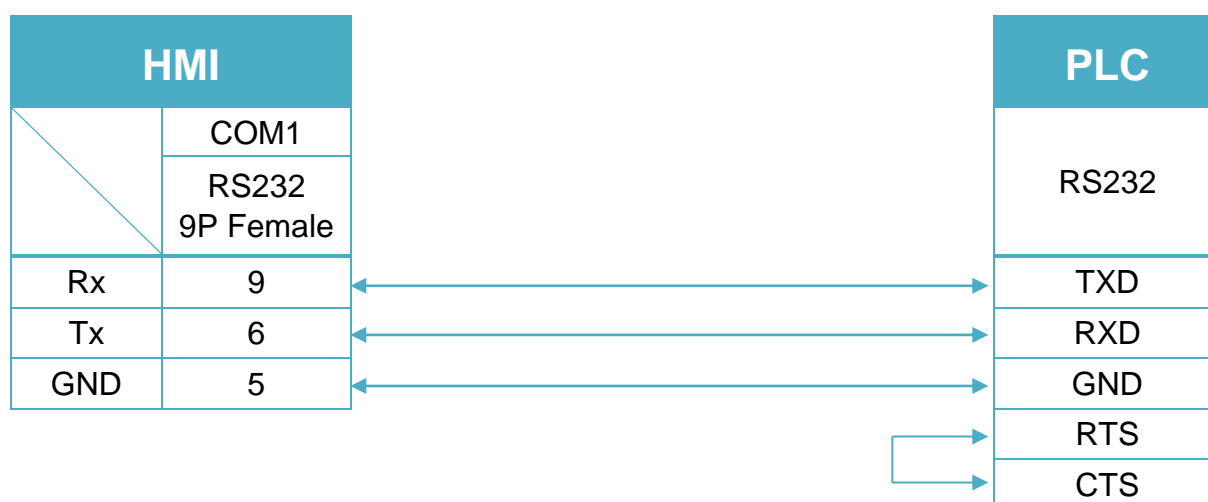


Diagram 3

MT-iE	MT8050iE
MT-iP	MT6051iP / MT6071iP / MT8071iP



RS485 4W (Diagram 4 ~ Diagram 7)

Diagram 4

cMT Series	<i>cMT3151</i>
eMT Series	<i>eMT3070 / eMT3105 / eMT3120 / eMT3150</i>
MT-iE	<i>MT8070iE / MT6070iE / MT8100iE / MT8121iE / MT8150iE</i>
MT-XE	<i>MT8121XE / MT8150XE</i>

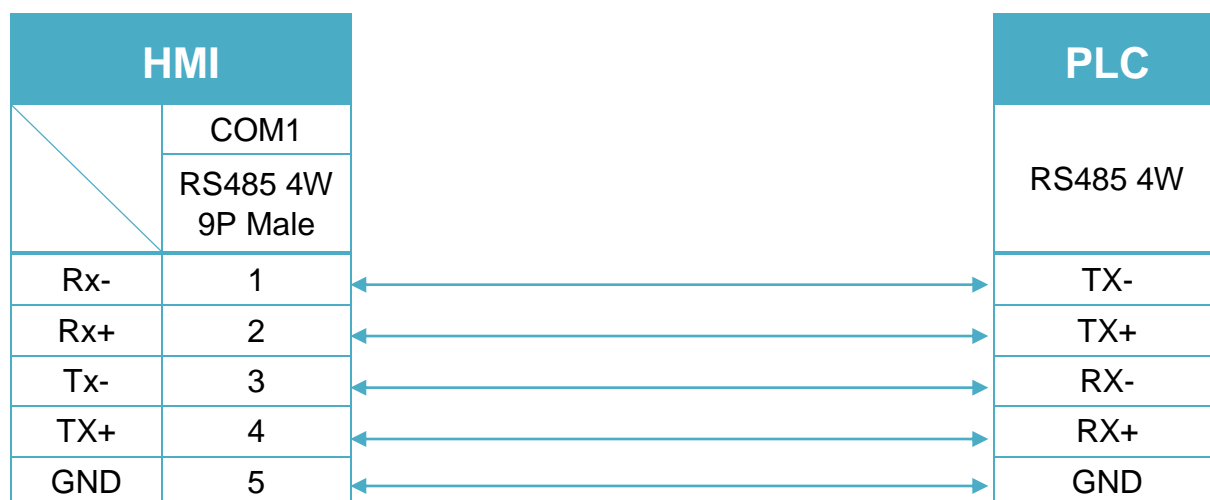


Diagram 5

cMT Series	<i>cMT-SVR</i>
mTV	<i>mTV</i>

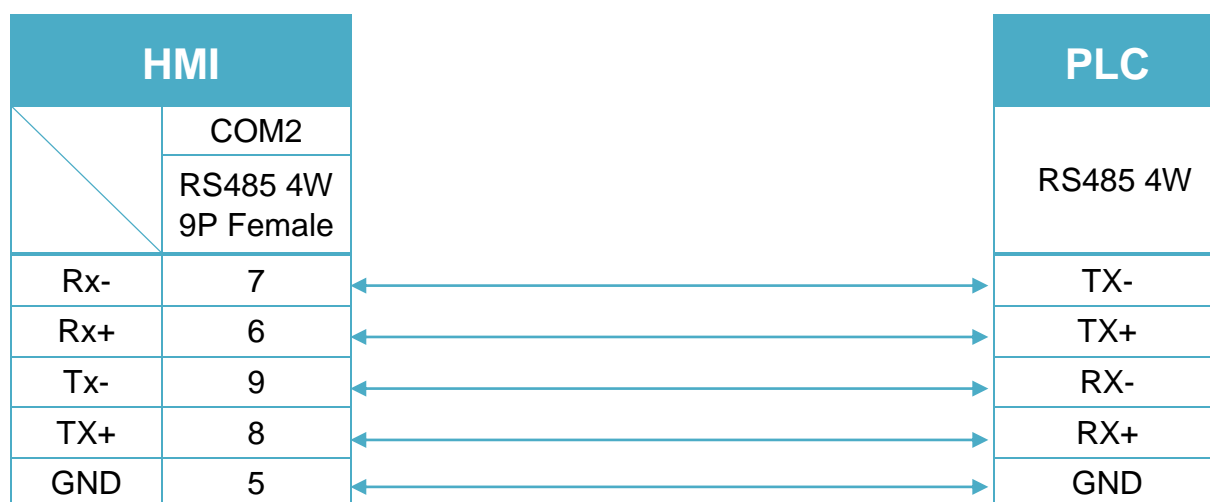


Diagram 6

MT-iE	<i>MT8071iE / MT6071iE / MT8072iE / MT6072iE / MT8073iE / MT8101iE / MT8102iE / MT8103iE</i>
MT-XE	<i>MT8090XE / MT8092XE</i>
MT-iP	<i>MT6071iP / MT8071iP / MT6103iP</i>

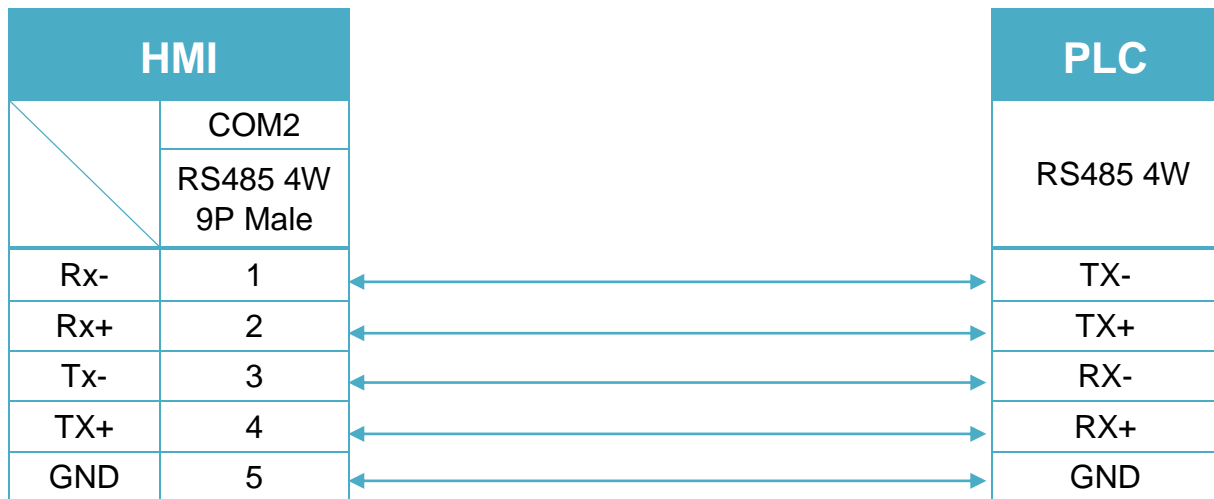
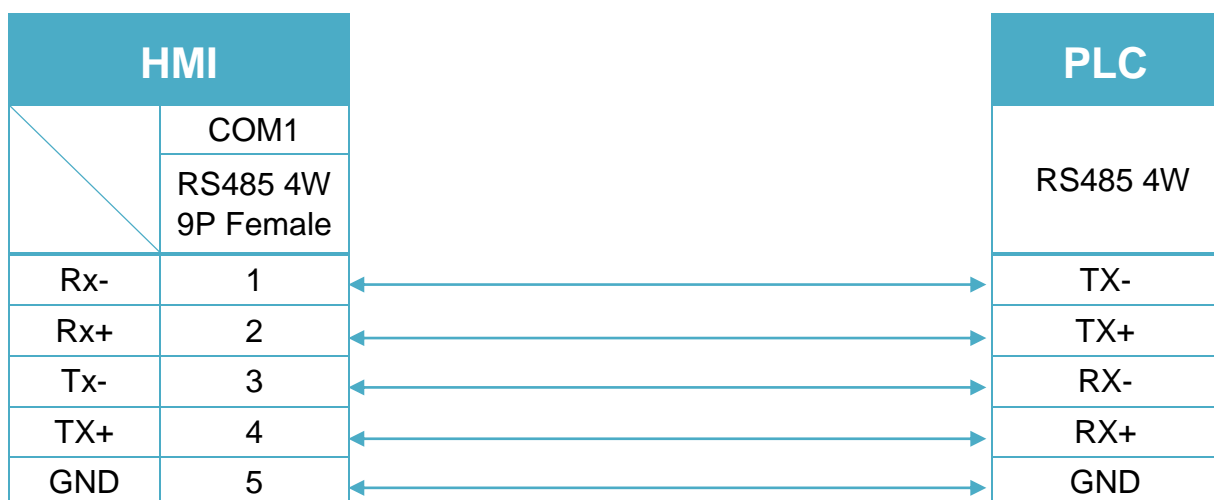


Diagram 7

MT-iE	<i>MT8050iE</i>
MT-iP	<i>MT6051iP</i>



RS485 2W (Diagram 8 ~ Diagram 13)

Diagram 8

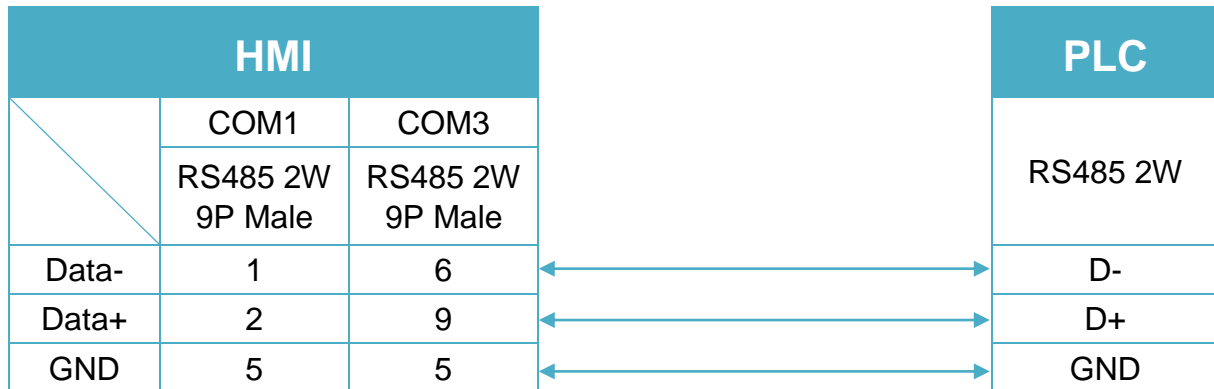
cMT Series
cMT3151
eMT Series
eMT3070 / eMT3105 / eMT3120 / eMT3150


Diagram 9

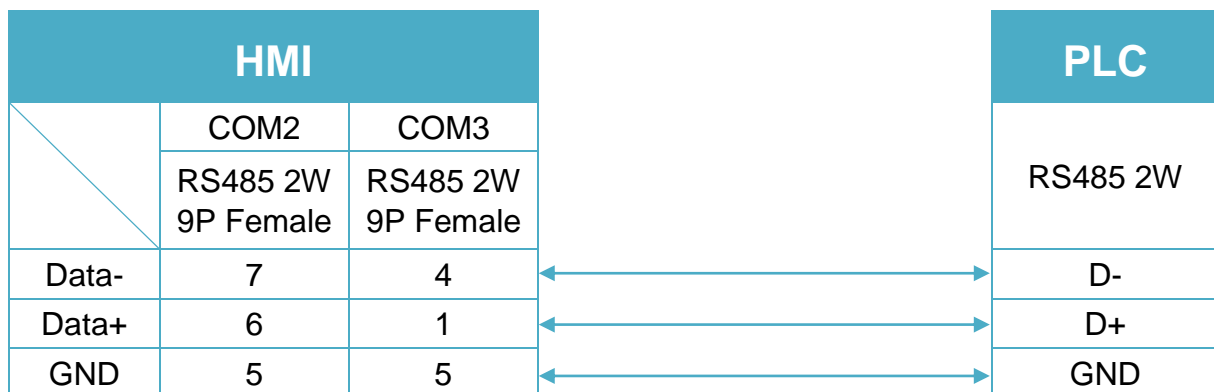
cMT Series
cMT-SVR
mTV
mTV


Diagram 10

MT-iE *MT8070iE / MT6070iE / MT8100iE / MT8121iE / MT8150iE*

MT-XE *MT8121XE / MT8150XE*

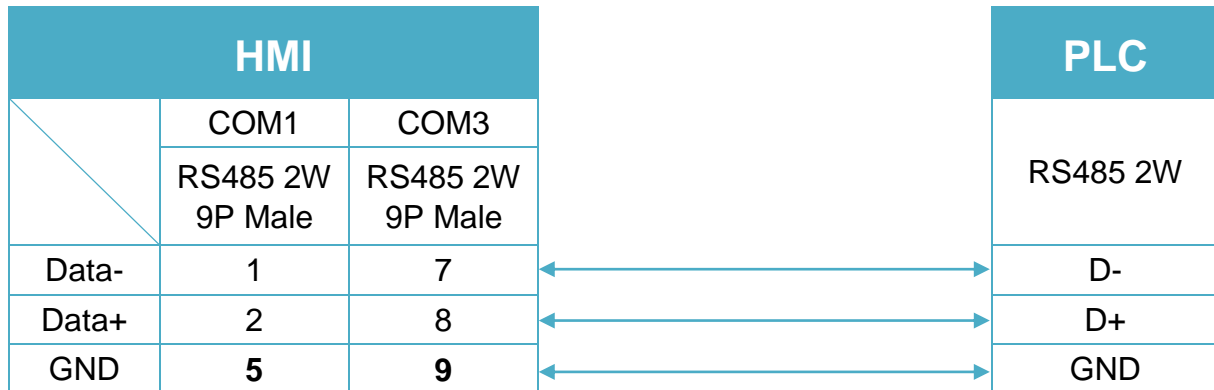


Diagram 11

MT-iE *MT8071iE / MT6071iE / MT8072iE / MT6072iE / MT8073iE /
MT8101iE / MT8102iE / MT8103iE*

MT-XE *MT8090XE / MT8092XE*

MT-iP *MT6103iP*

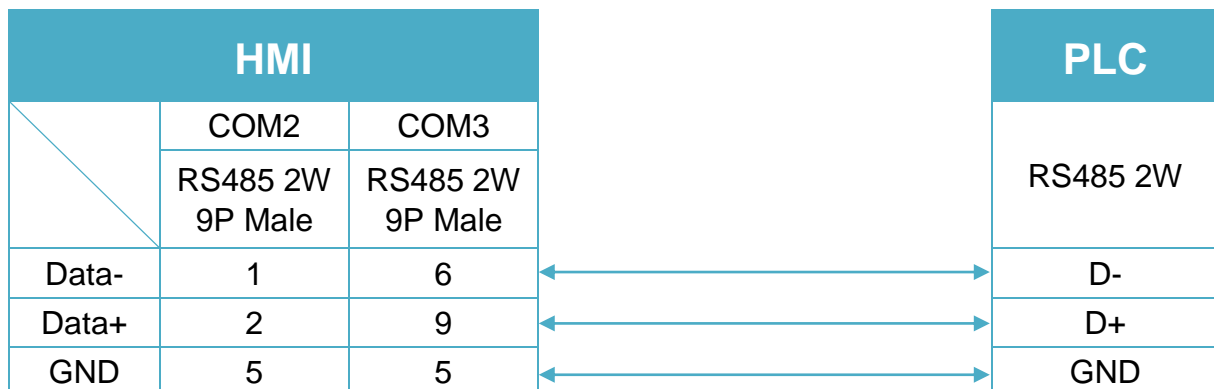


Diagram 12

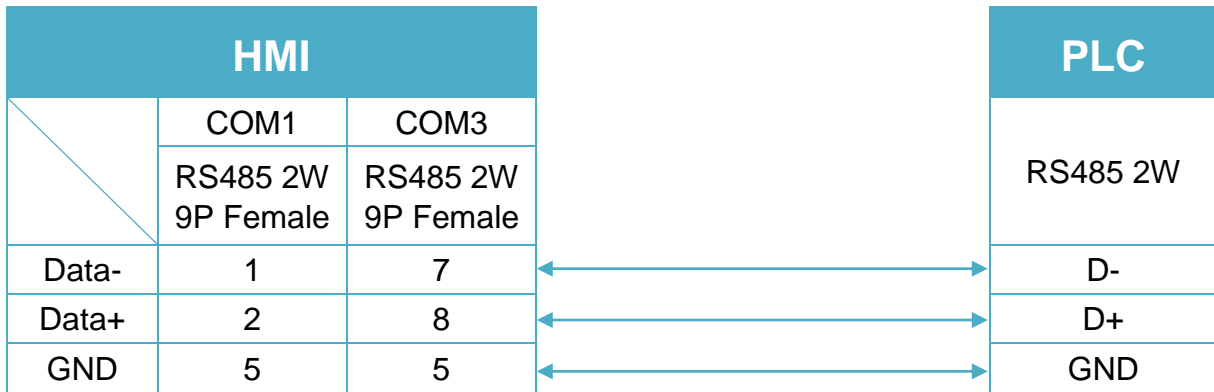
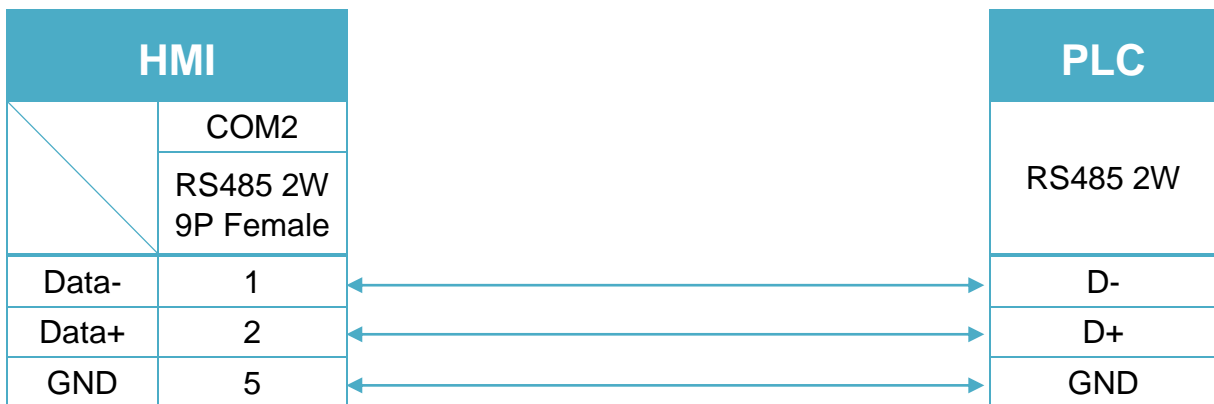
MT-iE *MT8050iE*
MT-iP *MT6051iP*


Diagram 13

MT-iP *MT6071iP / MT8071iP*


MODBUS RTU (0x/1x Range Adjustable)

Supported Series : MODBUS RTU CONTROLLER

Website : <http://www.modbus.org>

HMI Setting:

Parameters	Recommended	Options	Notes
PLC type	MODBUS RTU (0x/1x Range Adjustable)		
PLC I/F	RS485	RS232/RS485	
Baud rate	9600	9600~115200	
Data bits	8	7,8	
Parity	Even	Even, Odd, None	
Stop bits	1	1,2	
PLC sta. no.	1	0-255	

Online simulator	YES
Extend address mode	YES

PLC Setting:

Communication mode	Modbus RTU protocol
---------------------------	---------------------

Device Address:

Bit/Word	Device type	Format	Range	Memo
B	0x	DDDDD	1 ~ 65535	Output bit
B	1x	DDDDD	1 ~ 65535	Input bit (read only)
B	3x_Bit	DDDDDdd	100 ~ 6553515	Input Register bit (read only)
B	4x_Bit	DDDDDdd	100 ~ 6553515	Output Register bit
B	6x_Bit	DDDDDdd	100 ~ 6553515	Output Register bit
B	0x_multi_coils	DDDDD	1 ~ 65535	Write multiple coils
W	3x	DDDDD	1 ~ 65535	Input Register (read only)
W	4x	DDDDD	1 ~ 65535	Output Register
DW	5x	DDDDD	1 ~ 65535	4x double word swap *Note2
W	6x	DDDDD	1 ~ 65535	4x single word write
W	4x_32Bit*	DDDDD	1 ~ 65535	Output Register *Note1

*Note1: 4x_32Bit will only read / write 2 words for each package, for continuous addresses, it will be divided into several packages.

*Note2: Please assign all the addresses to Even addresses, or all to Odd addresses, in order to prevent communication failure.

NOTE:

Address type “5x” is mapping to Hold Reg. The communication protocol of “5x” is almost the same as “4x” except that “5x” swaps double words.

If 4x contains the following information:

Address	1	2	3	4	5	6	...
Data in word	0x1	0x2	0x3	0x4	0x5	0x6	
Data	0x0201		0x0403		0x0605		

For 5x, it will be:

Address	1	2	3	4	5	6	...
Data in word	0x1	0x2	0x3	0x4	0x5	0x6	
Data	0x0102		0x0304		0x0506		

Modbus RTU function code:

0x	0x01	Read coil	0x05	Write single coil
0x_multi_coils	0x01	Read coil	0x0f	Write multiple coils
1x	0x02	Read discrete input		N/A for writing operation
3x	0x04	Read input register		N/A for writing operation
4x	0x03	Read holding register	0x10	Write multiple registers
5x	0x03	Read holding register	0x10	Write multiple registers

(Note: reverse word order in double words format)


3xbit is equivalent to 3x

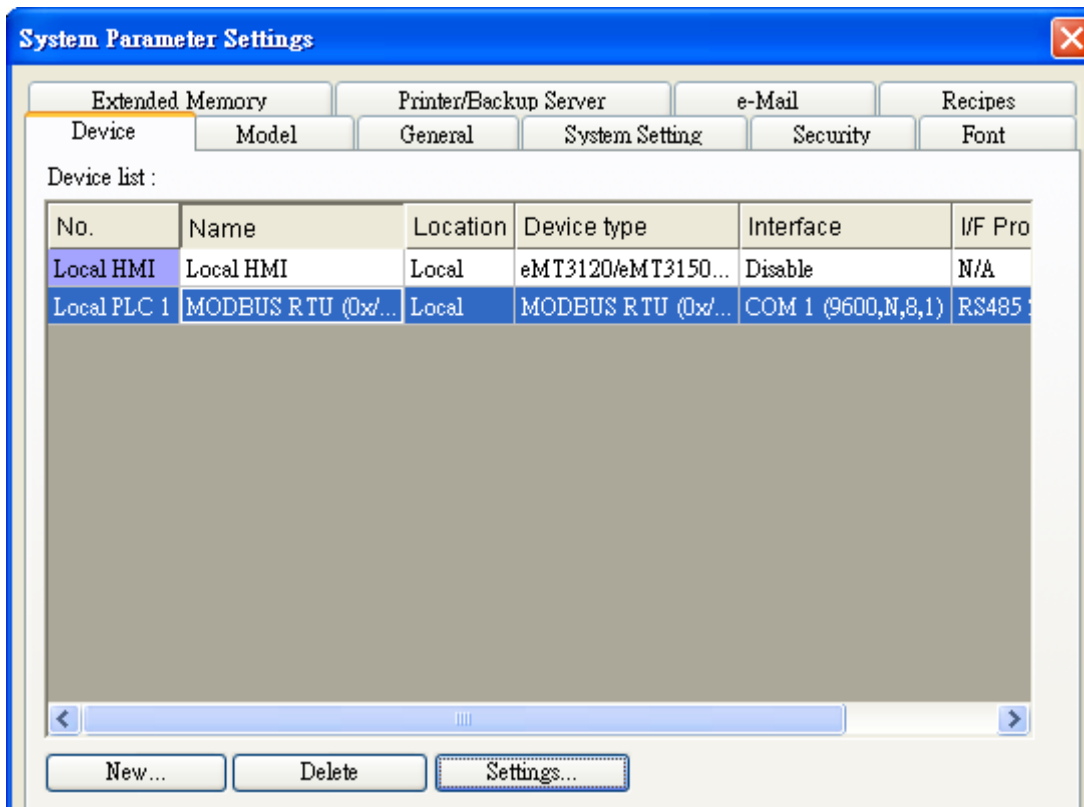
4xbit is equivalent to 4x

6x	0x03	Read holding register	0x06	Write single register
----	------	-----------------------	------	-----------------------

(Note: 6x is limited to device of one word only)

Setting Instructions:

- Go to [System Parameter Settings]  , click [New] to add a new device -Modbus RTU (0x 1x range adjustable) , as shown below:



- After adding Modbus RTU (0x 1x Range Adjustable) driver, [Add Address Range Limit] button will be enabled as below. Users can set maximum read/write command size here.

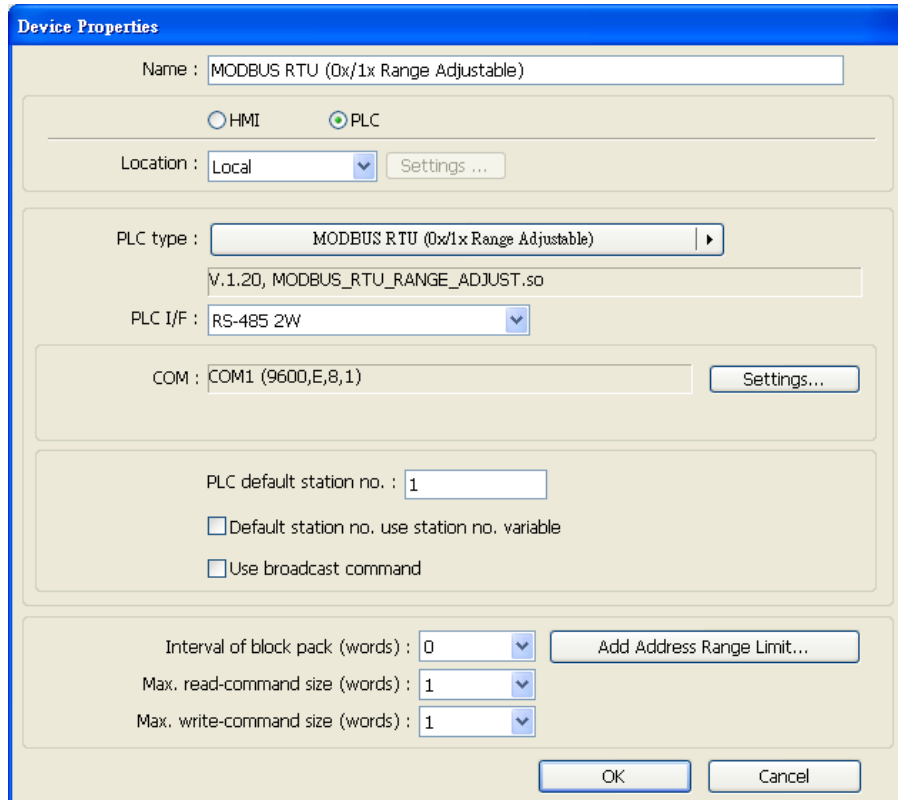
- Max.read-command size (words): Pull down to select PLC reading range.

Max. read-command size (words) :

- Max.write-command size (words): Pull down to select PLC writing range.

Max. write-command size (words) :

Note: Setting [Add Address Range Limit] is enabled only when bit address is not a multiple of 16bit.



Device Properties

Name : MODBUS RTU (0x/1x Range Adjustable)

HMI PLC

Location : Local

PLC type : MODBUS RTU (0x/1x Range Adjustable)

PLC I/F : RS-485 2W

COM : COM1 (9600,E,8,1)

PLC default station no. : 1

Default station no. use station no. variable

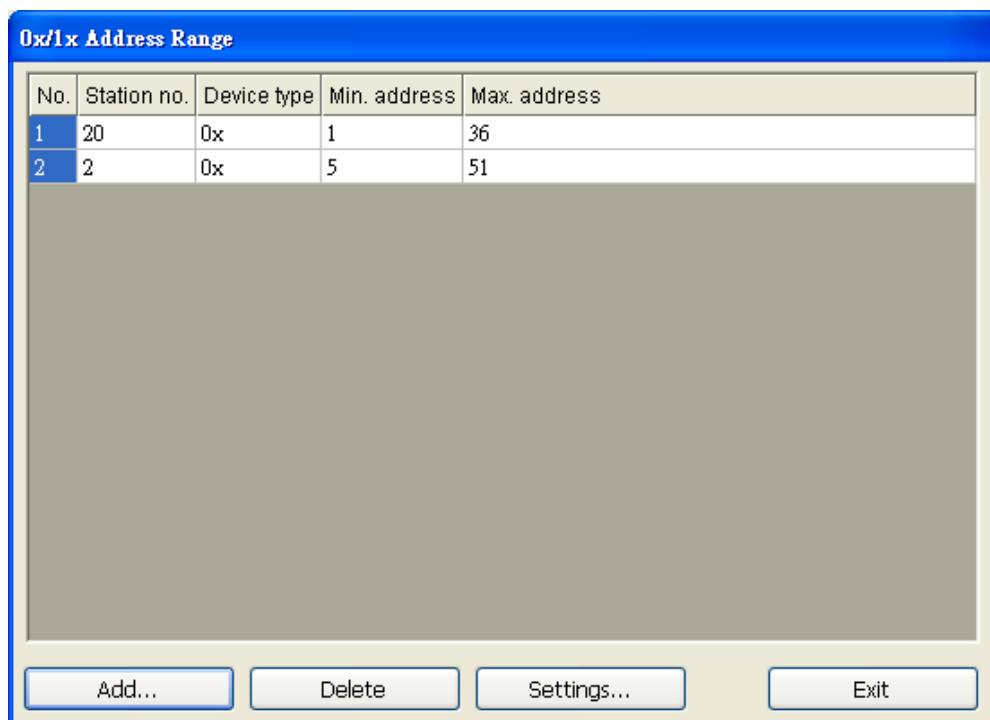
Use broadcast command

Interval of block pack (words) : 0

Max. read-command size (words) : 1

Max. write-command size (words) : 1

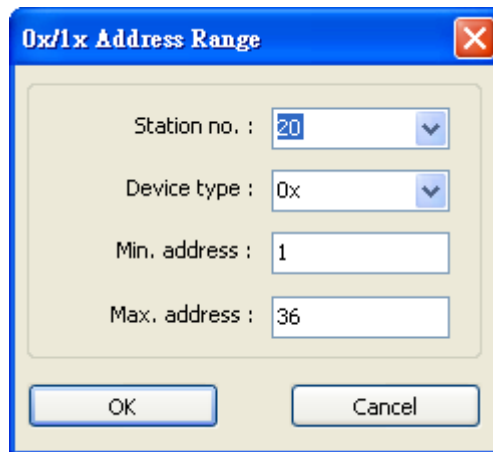
- Click [Add Address Range Limit] button, Users can define 0x , 1x and 0x_multi_coils address range in [0x 1x Address Range] dialog box, referring to bit range of the device used.



0x/1x Address Range

No.	Station no.	Device type	Min. address	Max. address
1	20	0x	1	36
2	2	0x	5	51

Add : Set [Station No.], [Device Type], [Min. Address], [Max. Address] then click [OK] to finish adding as below:



The dialog box titled "0x/1x Address Range" contains the following fields:

- Station no. : 20
- Device type : 0x
- Min. address : 1
- Max. address : 36

Buttons: OK, Cancel

Delete : The selected items will be deleted.

Settings : Set [Station No.], [Device Type], [Min. Address], [Max. Address] then click [OK] to finish adding as below:



The dialog box titled "0x/1x Address Range" contains the following fields:

- Station no. : 2
- Device type : 0x
- Min. address : 5
- Max. address : 51

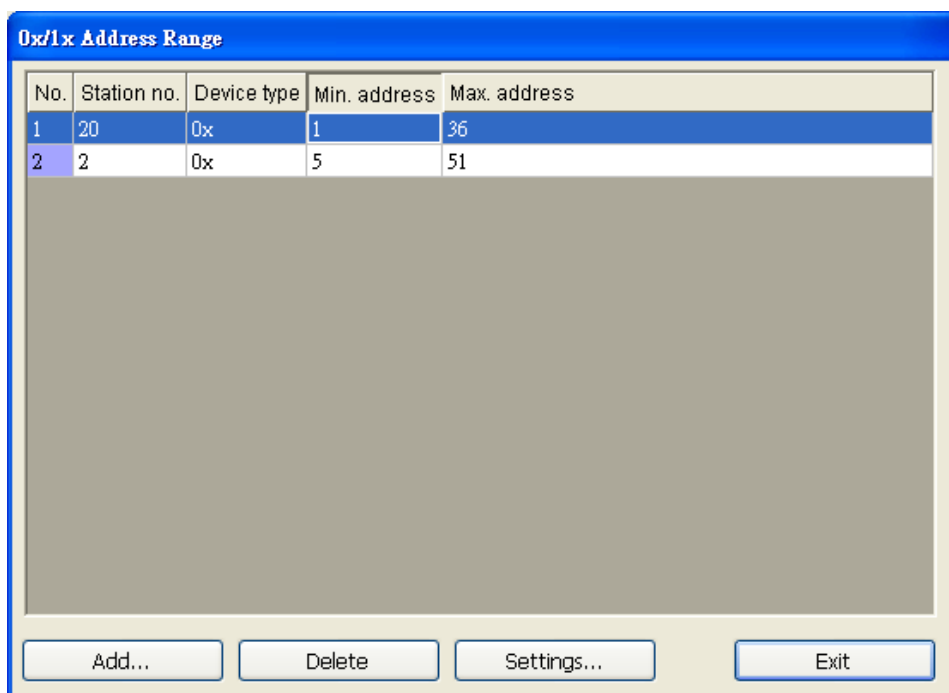
Buttons: OK, Cancel

Example :

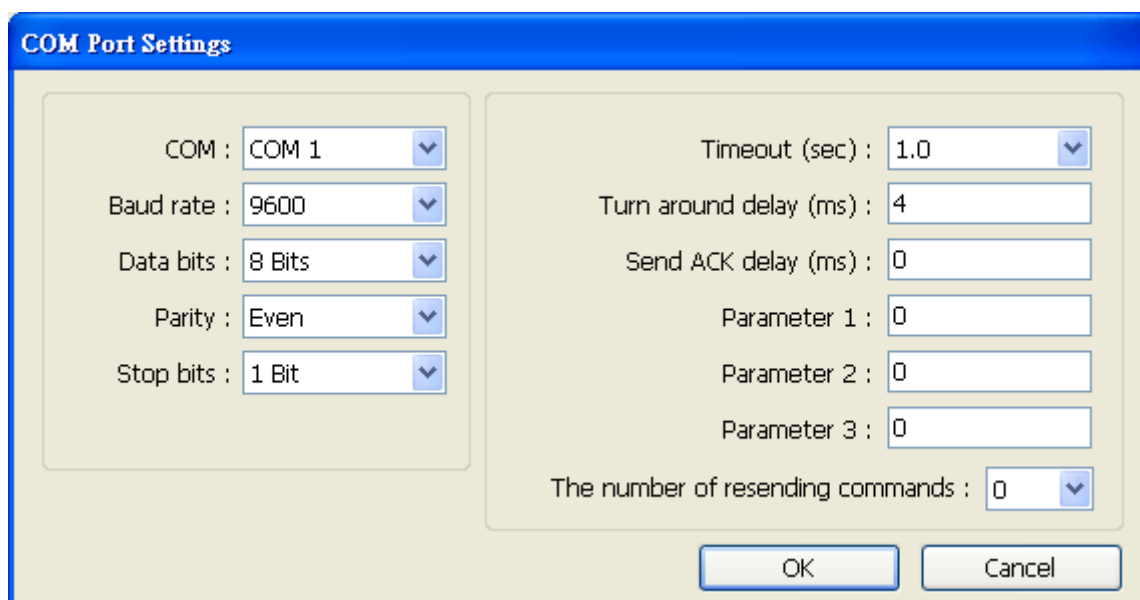
Take D2 and D8 of SCON as example, the settings depend on bit range of different PLC types. Set [Station No.] and address first.

For D2, set [Station No.] to **20**, [Device Type] **0x**, [Max. Address] **36**.

For D8, set [Station No.] to **2**, [Device Type] **0x**, [Max. Address] **51**.



Note: If communicating with a RS-485 2W PLC, the [Turn around delay] setting may need to be adjusted according to the reply speed of the device. Please click [Settings] in [Device Properties], and set the [Turn around delay (ms)] parameter as shown:



After completing all settings above, the communication is enabled.

Wiring Diagram:

RS232 (Diagram 1 ~ Diagram 3)

Diagram 1

cMT Series	<i>cMT3151</i>
eMT Series	<i>eMT3070 / eMT3105 / eMT3120 / eMT3150</i>
MT-iE	<i>MT8073iE / MT8102iE</i>
MT-XE	<i>MT8092XE</i>
MT-iP	<i>MT6103iP</i>

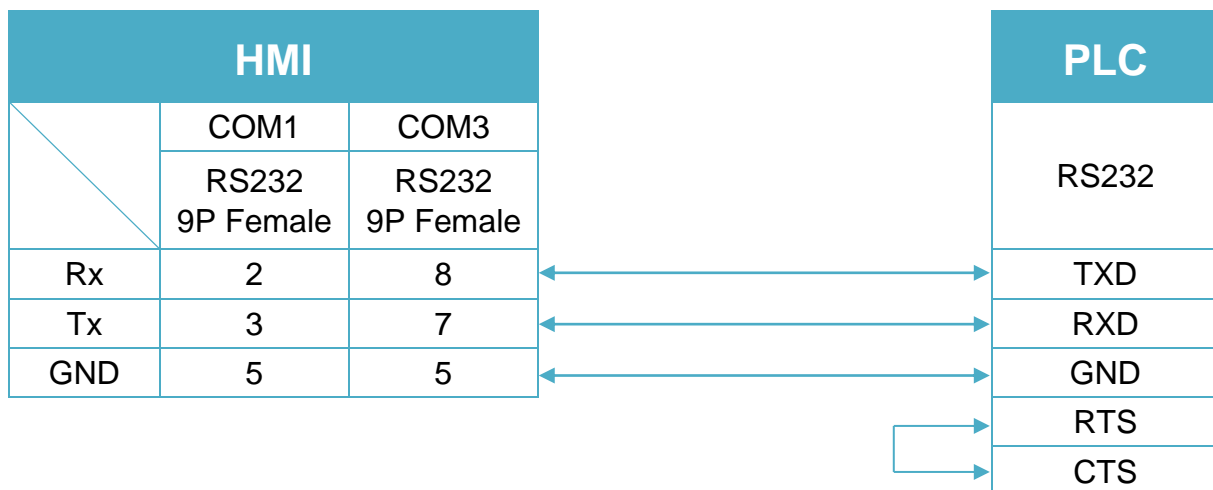


Diagram 2

cMT Series	cMT-SVR
mTV	mTV
MT-iE	MT8070iE / MT6070iE / MT8100iE / MT8121iE / MT8150iE / MT8071iE / MT6071iE / MT8072iE / MT6072iE / MT8073iE / MT8101iE / MT8102iE / MT8103iE
MT-XE	MT8121XE / MT8150XE / MT8090XE /

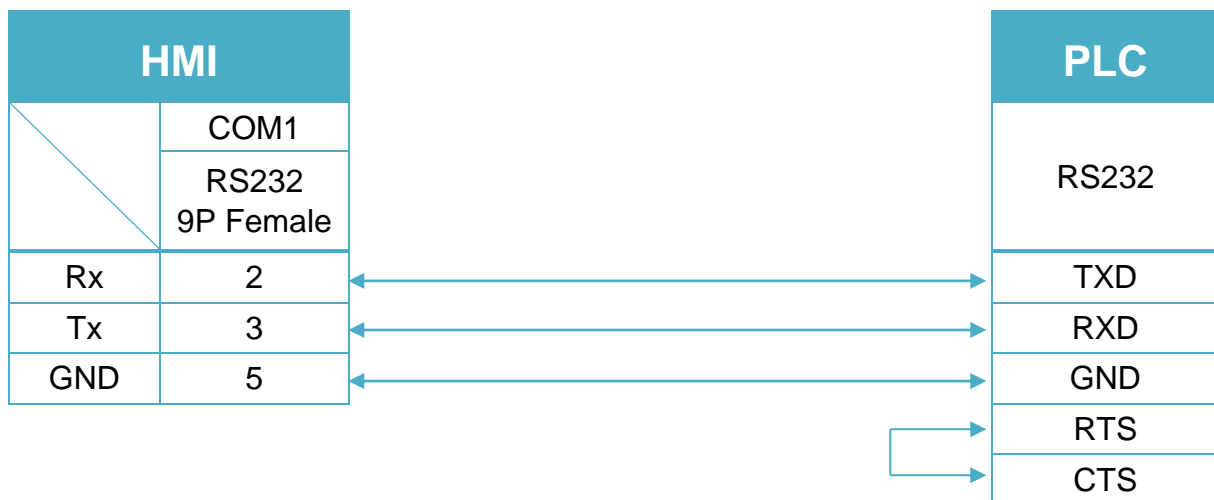
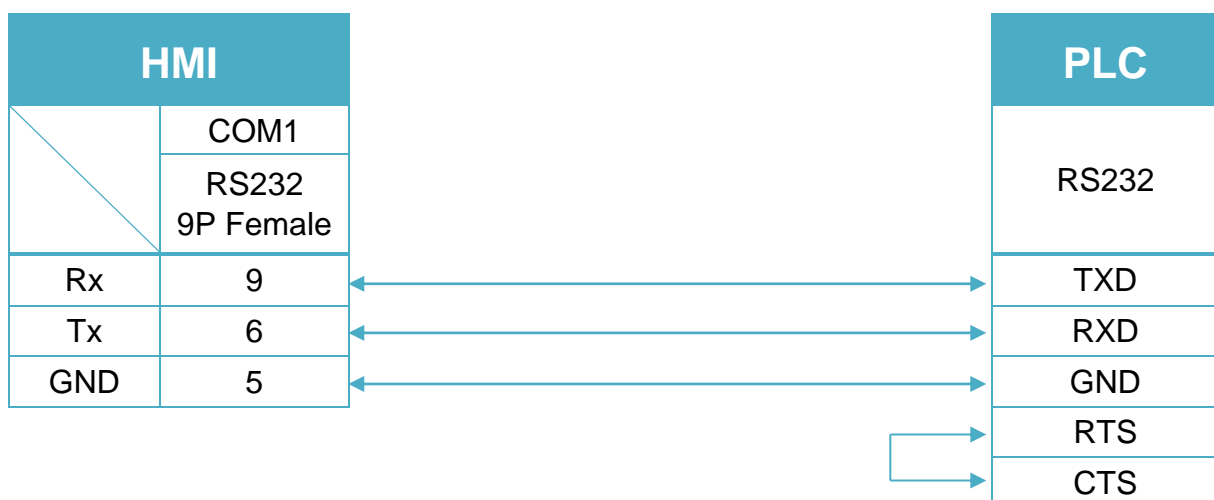


Diagram 3

MT-iE	MT8050iE
MT-iP	MT6051iP / MT6071iP / MT8071iP



RS485 4W (Diagram 4 ~ Diagram 7)

Diagram 4

cMT Series	<i>cMT3151</i>
eMT Series	<i>eMT3070 / eMT3105 / eMT3120 / eMT3150</i>
MT-iE	<i>MT8070iE / MT6070iE / MT8100iE / MT8121iE / MT8150iE</i>
MT-XE	<i>MT8121XE / MT8150XE</i>

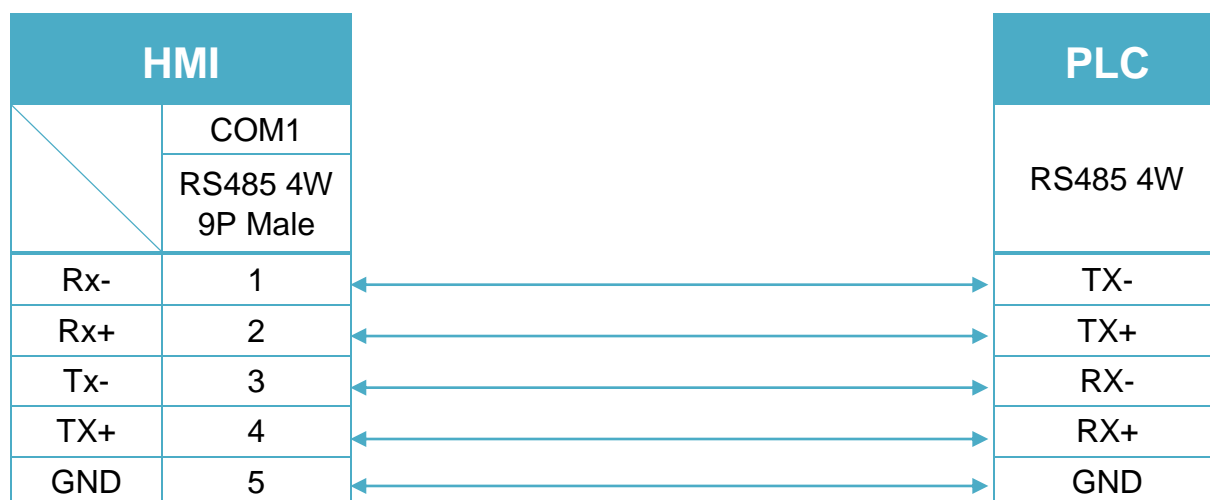


Diagram 5

cMT Series	<i>cMT-SVR</i>
mTV	<i>mTV</i>

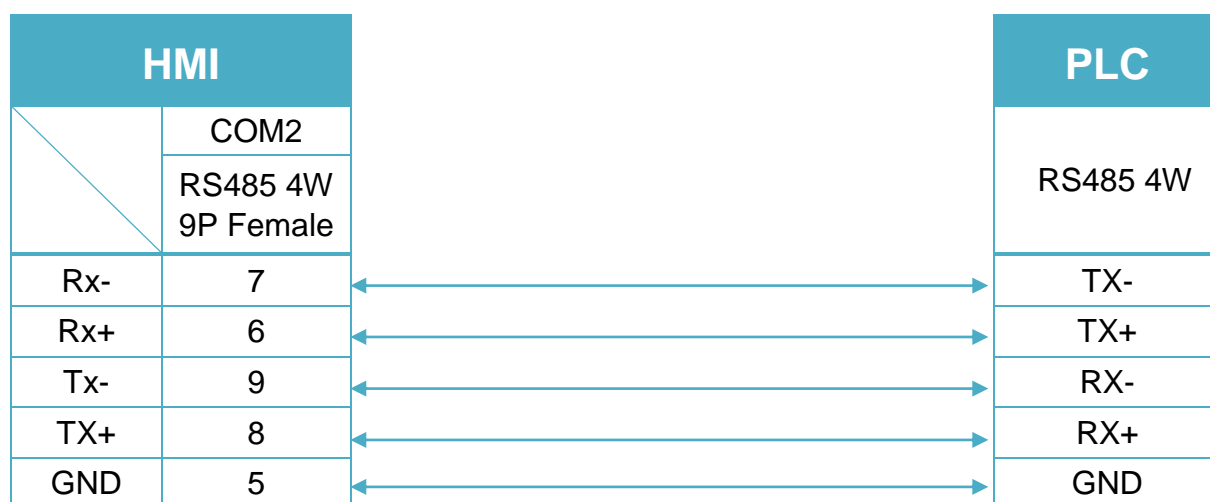


Diagram 6

MT-iE	<i>MT8071iE / MT6071iE / MT8072iE / MT6072iE / MT8073iE / MT8101iE / MT8102iE / MT8103iE</i>
MT-XE	<i>MT8090XE / MT8092XE</i>
MT-iP	<i>MT6071iP / MT8071iP / MT6103iP</i>

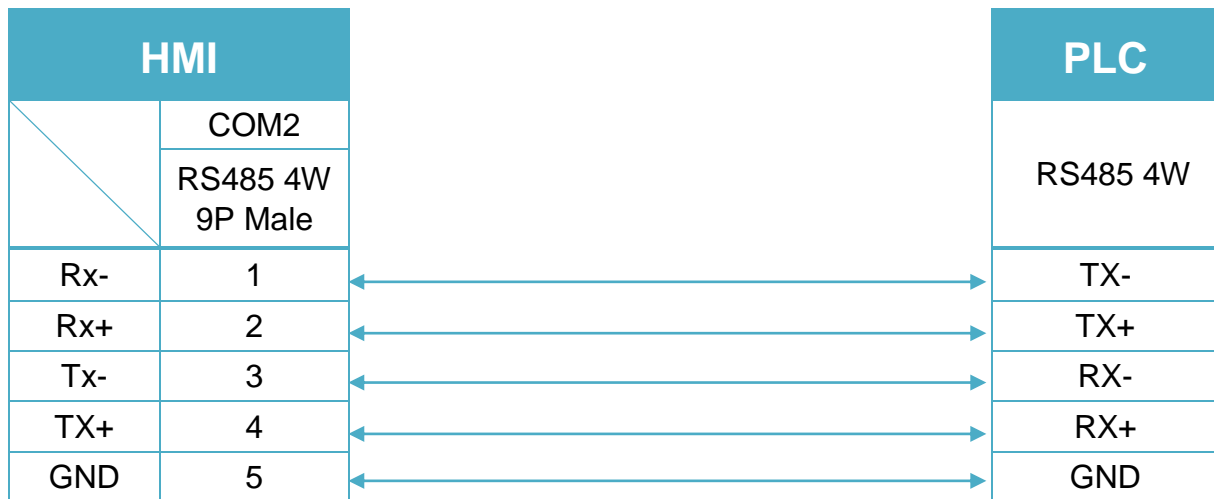
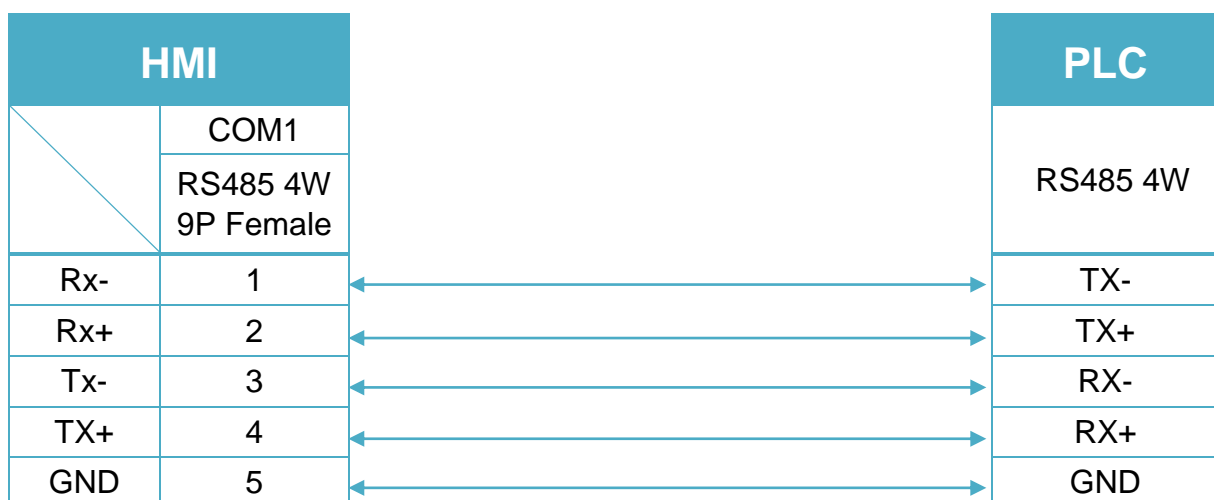


Diagram 7

MT-iE	<i>MT8050iE</i>
MT-iP	<i>MT6051iP</i>



RS485 2W (Diagram 8 ~ Diagram 13)

Diagram 8

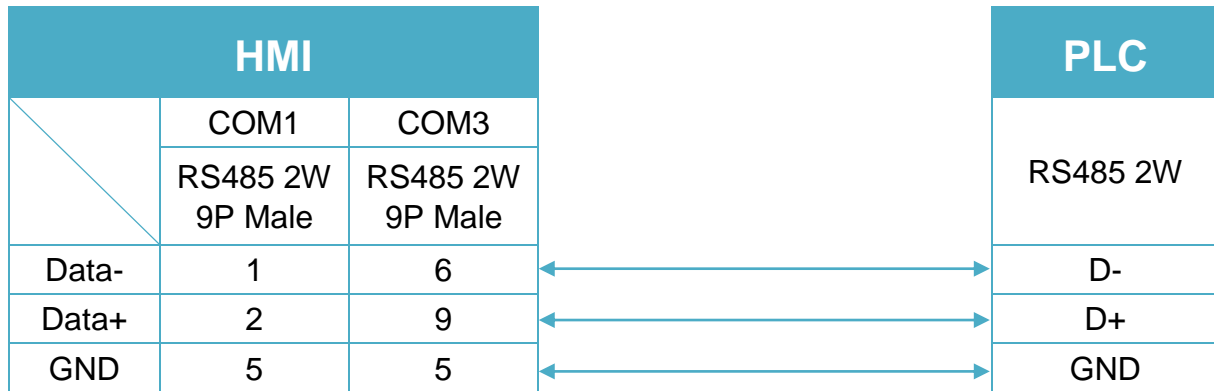
cMT Series
cMT3151
eMT Series
eMT3070 / eMT3105 / eMT3120 / eMT3150


Diagram 9

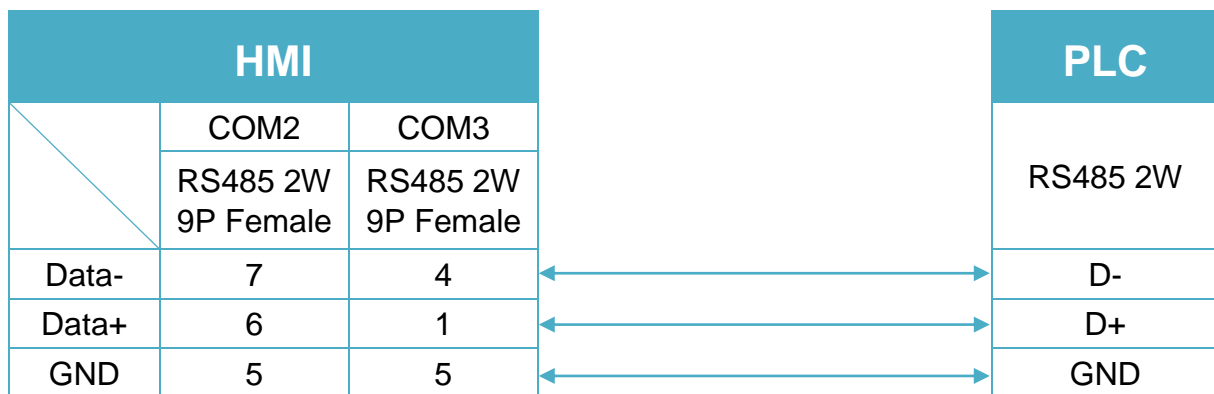
cMT Series
cMT-SVR
mTV
mTV


Diagram 10

MT-iE *MT8070iE / MT6070iE / MT8100iE / MT8121iE / MT8150iE*

MT-XE *MT8121XE / MT8150XE*

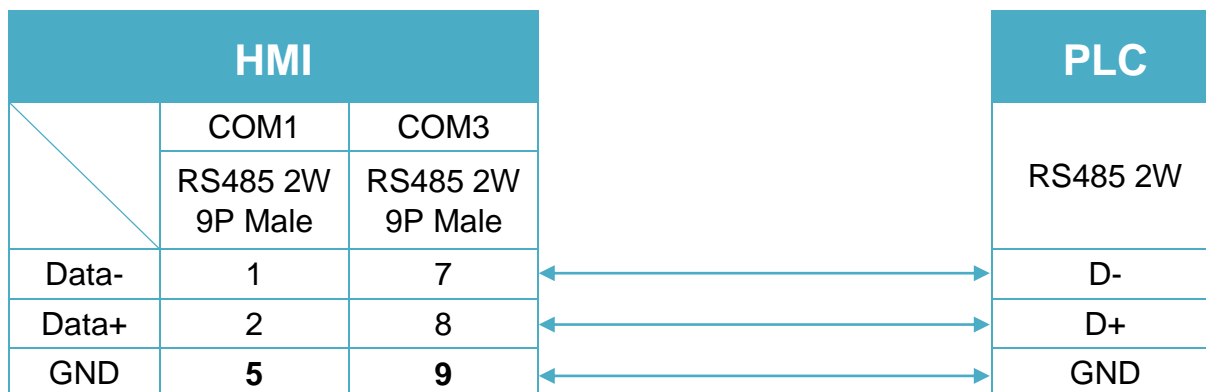


Diagram 11

MT-iE *MT8071iE / MT6071iE / MT8072iE / MT6072iE / MT8073iE /
MT8101iE / MT8102iE / MT8103iE*

MT-XE *MT8090XE / MT8092XE*

MT-iP *MT6103iP*

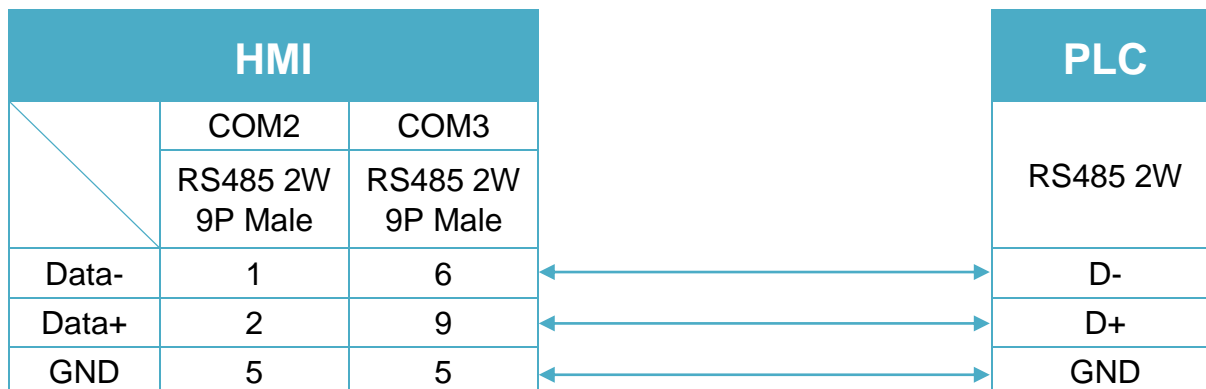


Diagram 12

MT-iE ***MT8050iE***

MT-iP ***MT6051iP***

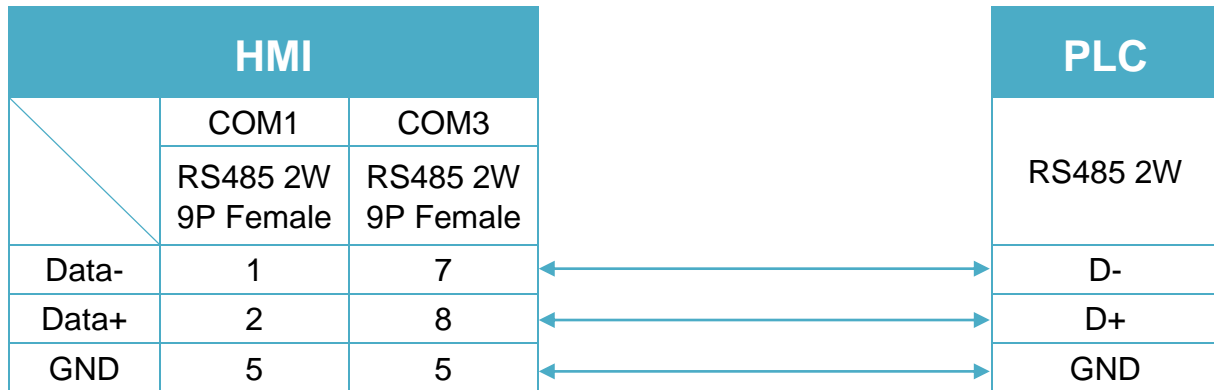


Diagram 13

MT-iP ***MT6071iP / MT8071iP***



MODBUS RTU (Adjustable)

Supported Series : MODBUS RTU CONTROLLER

Website : <http://www.modbus.org>

HMI Setting:

Parameters	Recommended	Options	Notes
PLC type	MODBUS RTU (Adjustable)		
PLC I/F	RS485	RS232/RS485	
Baud rate	9600	9600/19200/38400/57600/115200	
Data bits	8	7,8	
Parity	Even	Even, Odd, None	
Stop bits	1	1,2	
PLC sta. no.	1	0-255	

Online simulator	YES
Extend address mode	YES

PLC Setting:

Communication mode	Modbus RTU protocol
--------------------	---------------------

Device Address:

Bit/Word	Device type	Format	Range	Memo
B	0x	DDDDD	1 ~ 65535	Output bit
B	1x	DDDDD	1 ~ 65535	Input bit (read only)
B	3x_Bit	DDDDDdd	100 ~ 6553515	Input Register bit (read only)
B	4x_Bit	DDDDDdd	100 ~ 6553515	Output Register bit
B	0x_multi_coils	DDDDD	1 ~ 65535	Write multiple coils
W	3x	DDDDD	1 ~ 65535	Input Register (read only)
W	4x	DDDDD	1 ~ 65535	Output Register
W	5x	DDDDD	1 ~ 65535	4x double word swap *Note1
DW	5x (32-bit)	DDDDD	1 ~ 65535	4x double word
W	6x	DDDDD	1 ~ 65535	4x single word write

*Note1: Please assign all the addresses to Even addresses, or all to Odd addresses, in order to prevent communication failure.

NOTE:

Address type “5x” is mapping to Hold Reg. The communication protocol of “5x” is almost the same as “4x” except that “5x” swaps double words.

If 4x contains the following information:

Address	1	2	3	4	5	6	...
Data in word	0x1	0x2	0x3	0x4	0x5	0x6	
Data	0x0201		0x0403		0x0605		

For 5x, it will be:

Address	1	2	3	4	5	6	...
Data in word	0x1	0x2	0x3	0x4	0x5	0x6	
Data	0x0102		0x0304		0x0506		

Modbus RTU function code:

0x	0x01	Read coil	0x05	Write single coil
0x_multi_coils	0x01	Read coil	0x0f	Write multiple coils
1x	0x02	Read discrete input		N/A for writing operation
3x	0x04	Read input register		N/A for writing operation
4x	0x03	Read holding register	0x10	Write multiple registers
5x	0x03	Read holding register	0x10	Write multiple registers

(Note: reverse word order in double words format)


3xbit is equivalent to 3x

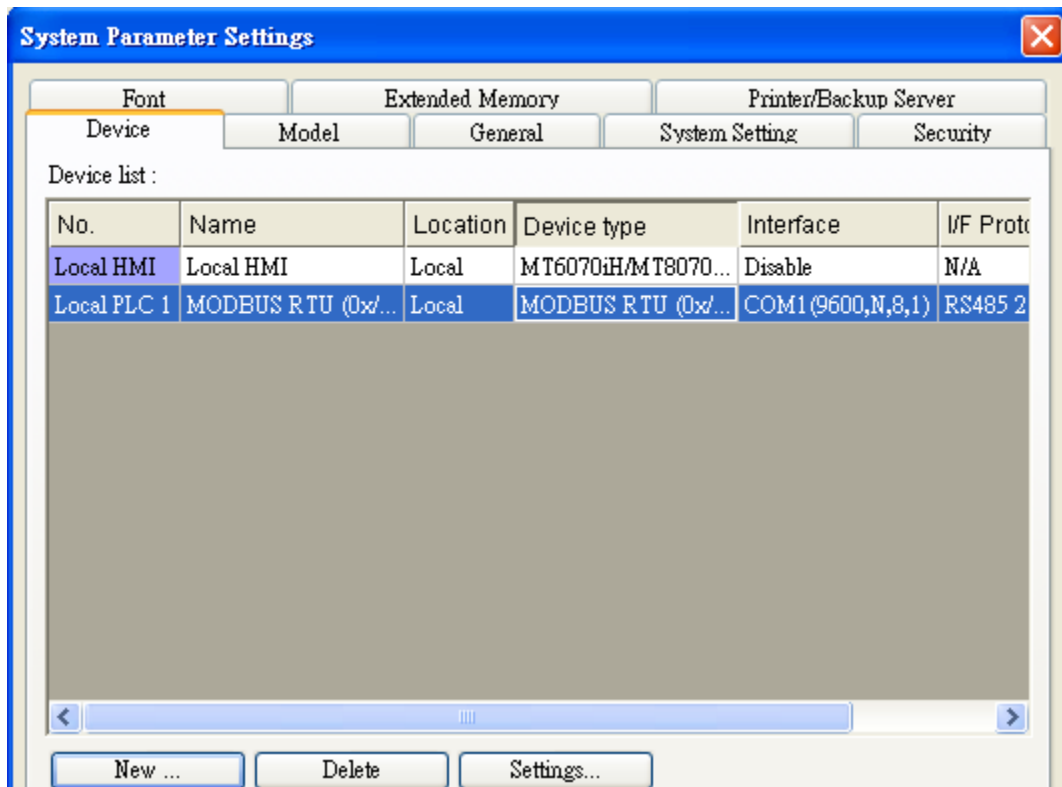
4xbit is equivalent to 4x

6x	0x03	Read holding register	0x06	Write single register
----	------	-----------------------	------	-----------------------

(Note: 6x is limited to device of one word only)

Setting Instructions:

- Go to [System Parameter Settings]  , click [New] to add a new device - MODBUS RTU (Adjustable) , as shown below:



- After adding MODBUS RTU (Adjustable) driver, [Add Address Range Limit] button will be enabled as below. Users can set maximum read/write command size here.

- Max.read-command size (words): Pull down to select PLC reading range.

Max. read-command size (words) :

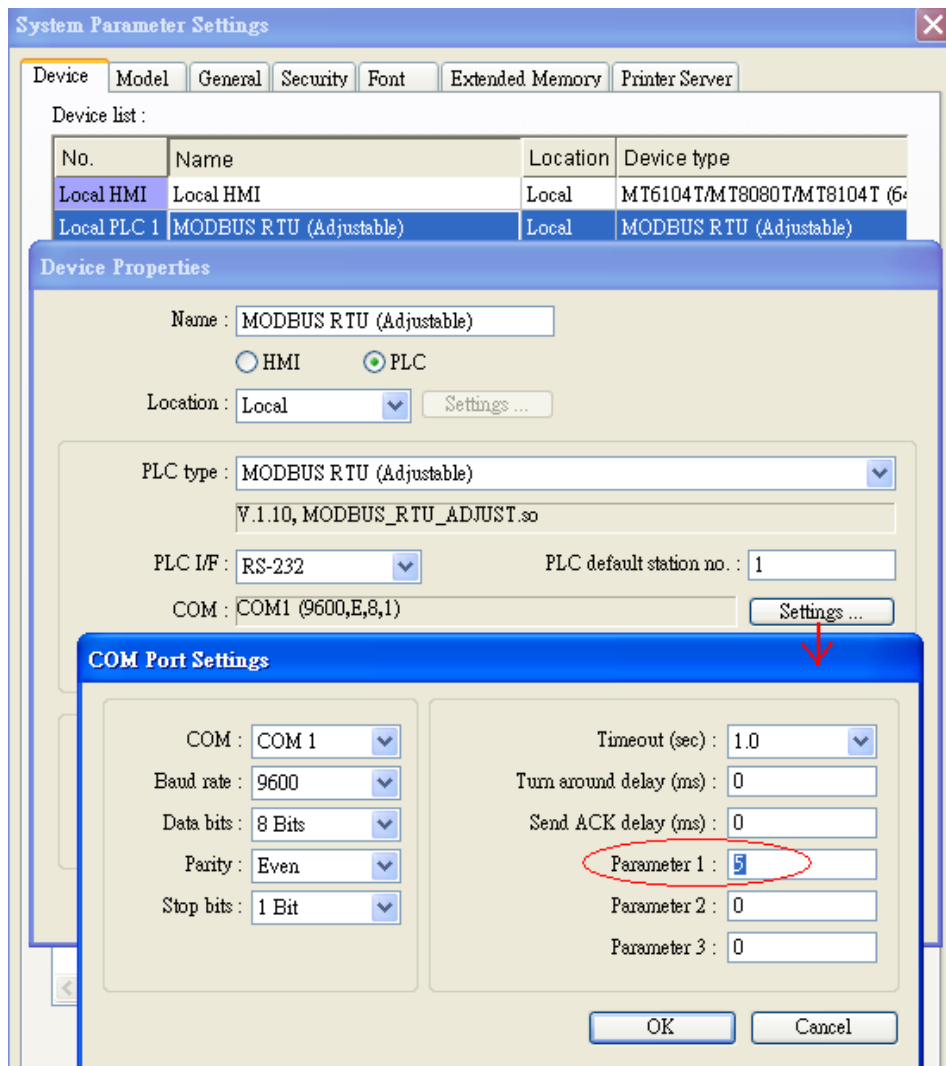
- Max.write-command size (words): Pull down to select PLC writing range.

Max. write-command size (words) :

Note:

MODBUS RTU (adjustable) usage

Users can decide the address range via setting value on Parameter 1. For example, when users set 5 to Parameter 1, the address range will be 5 ~ 65535.



Wiring Diagram:

RS232 (Diagram 1 ~ Diagram 3)

Diagram 1

cMT Series	<i>cMT3151</i>
eMT Series	<i>eMT3070 / eMT3105 / eMT3120 / eMT3150</i>
MT-iE	<i>MT8073iE / MT8102iE</i>
MT-XE	<i>MT8092XE</i>
MT-iP	<i>MT6103iP</i>

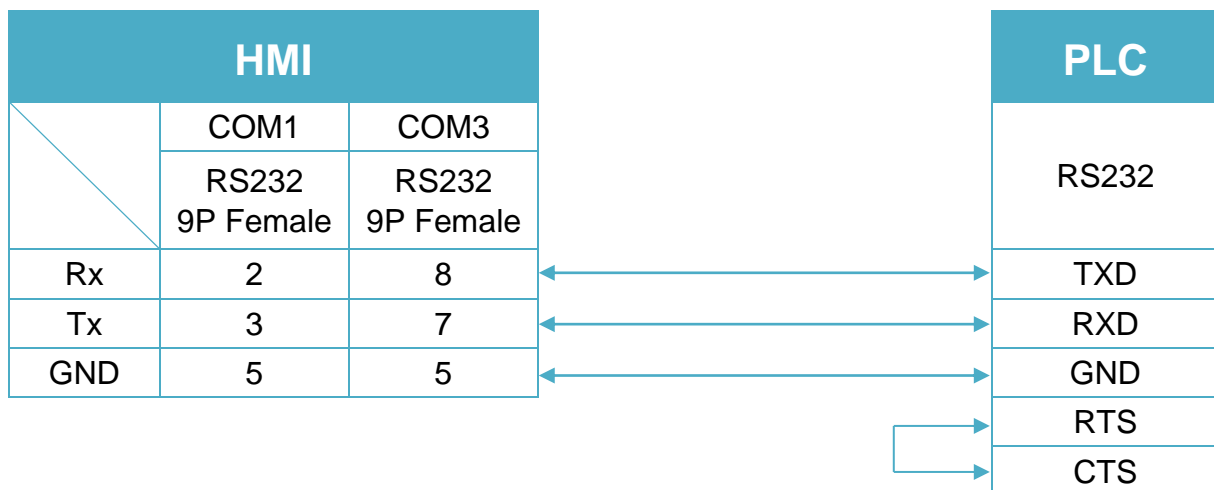


Diagram 2

cMT Series	cMT-SVR
mTV	mTV
MT-iE	MT8070iE / MT6070iE / MT8100iE / MT8121iE / MT8150iE / MT8071iE / MT6071iE / MT8072iE / MT6072iE / MT8073iE / MT8101iE / MT8102iE / MT8103iE
MT-XE	MT8121XE / MT8150XE / MT8090XE /

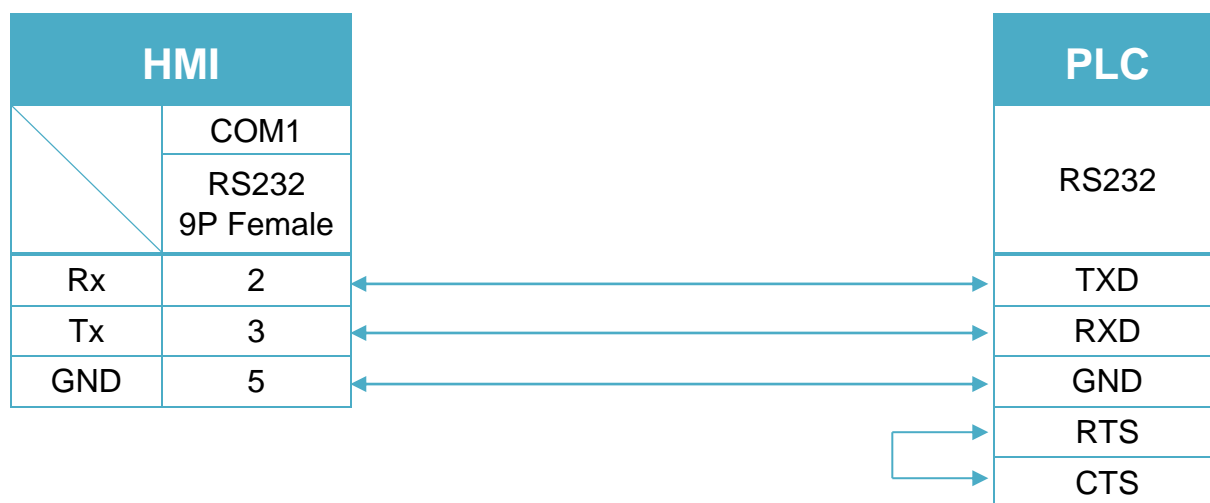
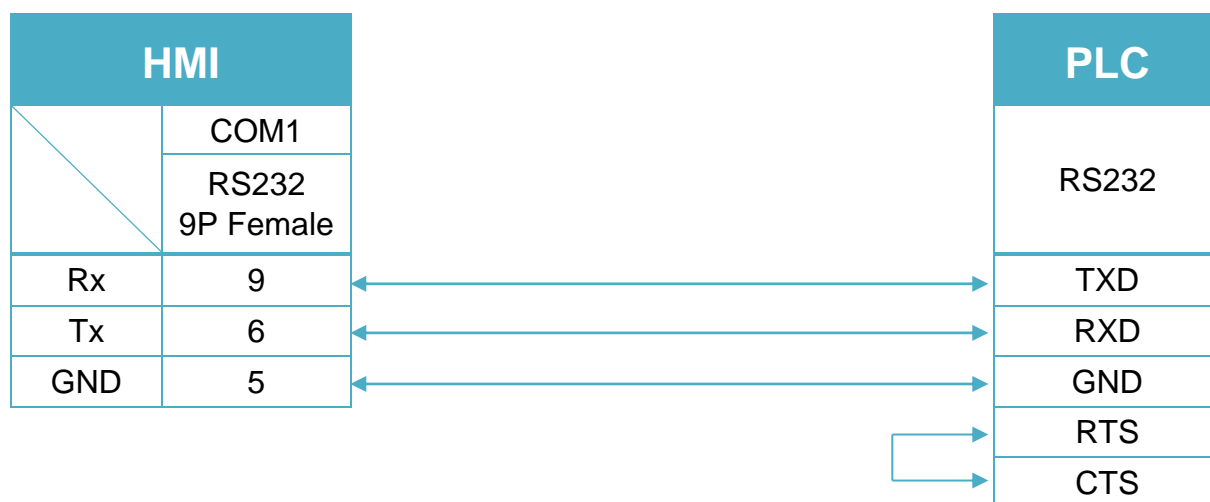


Diagram 3

MT-iE	MT8050iE
MT-iP	MT6051iP / MT6071iP / MT8071iP



RS485 4W (Diagram 4 ~ Diagram 7)

Diagram 4

cMT Series	<i>cMT3151</i>
eMT Series	<i>eMT3070 / eMT3105 / eMT3120 / eMT3150</i>
MT-iE	<i>MT8070iE / MT6070iE / MT8100iE / MT8121iE / MT8150iE</i>
MT-XE	<i>MT8121XE / MT8150XE</i>

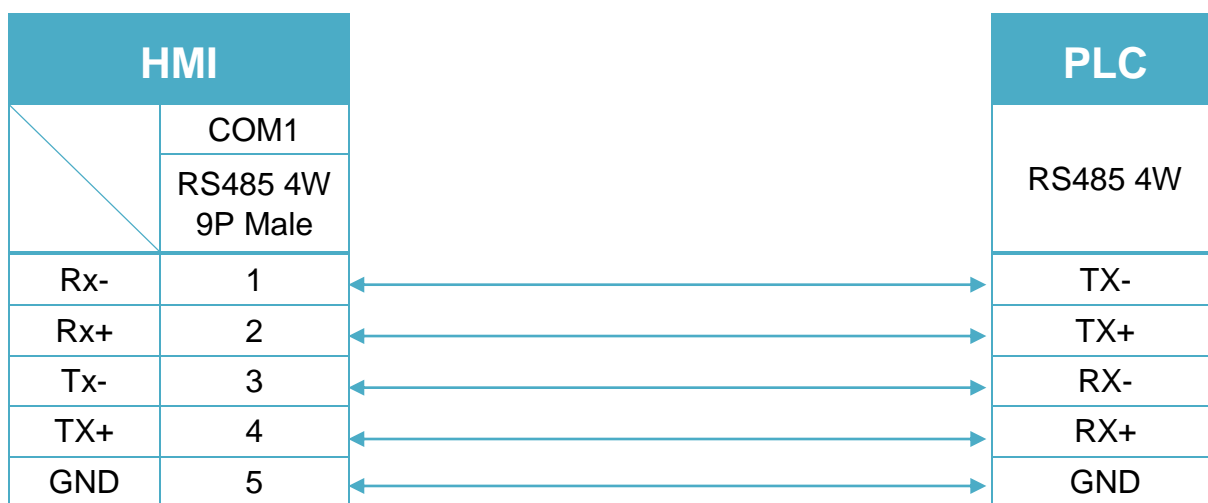


Diagram 5

cMT Series	<i>cMT-SVR</i>
mTV	<i>mTV</i>

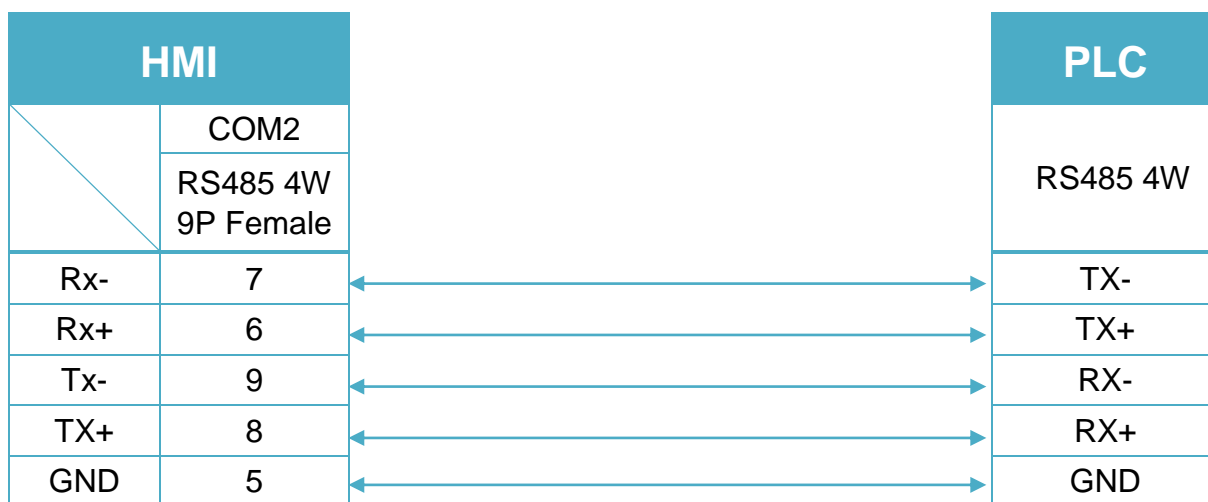


Diagram 6

MT-iE	<i>MT8071iE / MT6071iE / MT8072iE / MT6072iE / MT8073iE / MT8101iE / MT8102iE / MT8103iE</i>
MT-XE	<i>MT8090XE / MT8092XE</i>
MT-iP	<i>MT6071iP / MT8071iP / MT6103iP</i>

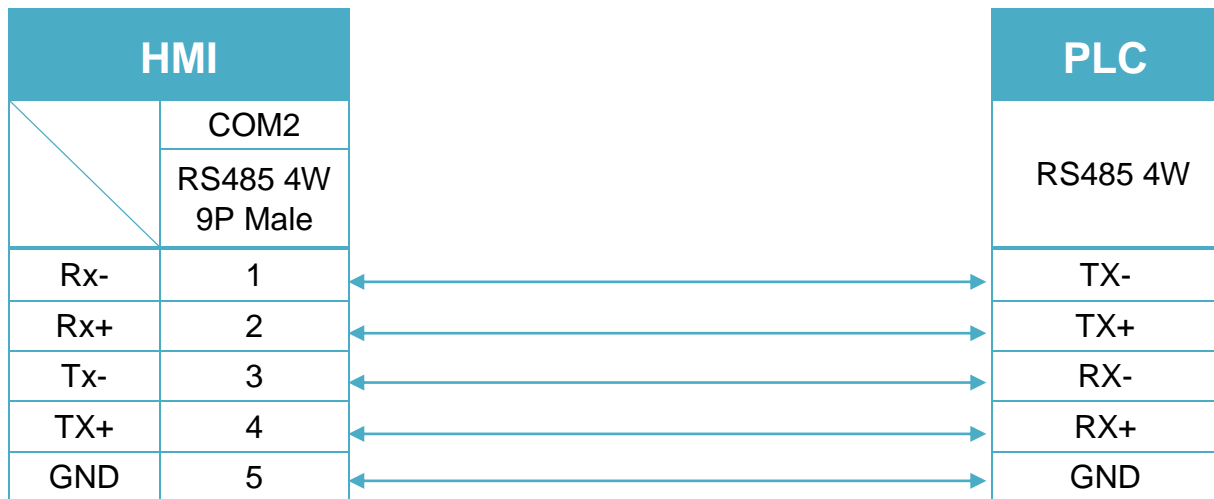
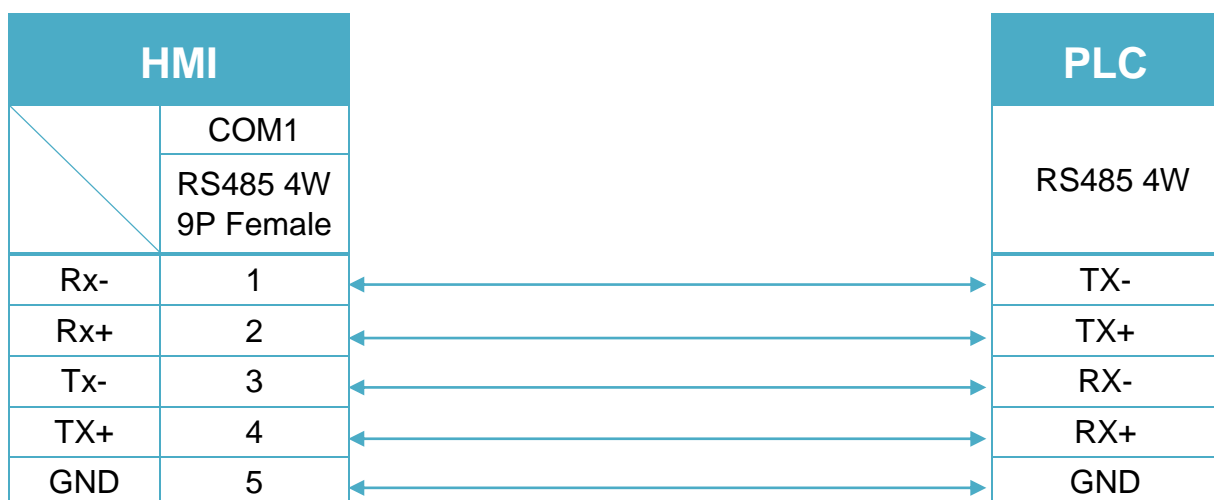


Diagram 7

MT-iE	<i>MT8050iE</i>
MT-iP	<i>MT6051iP</i>



RS485 2W (Diagram 8 ~ Diagram 13)

Diagram 8

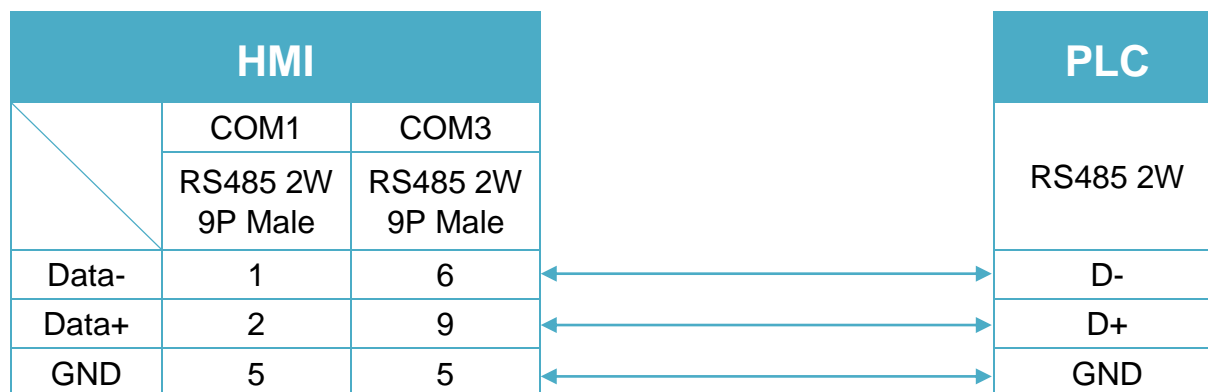
cMT Series
cMT3151
eMT Series
eMT3070 / eMT3105 / eMT3120 / eMT3150


Diagram 9

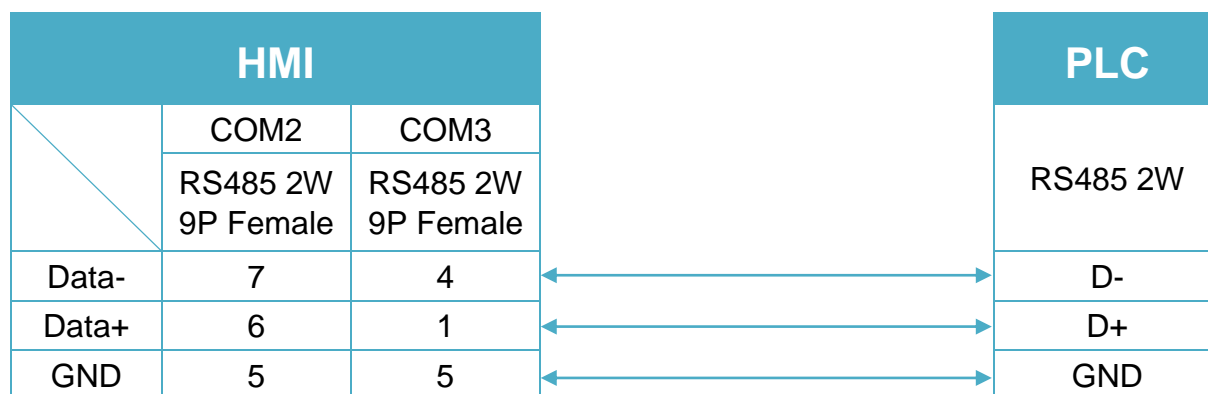
cMT Series
cMT-SVR
mTV
mTV


Diagram 10

MT-iE *MT8070iE / MT6070iE / MT8100iE / MT8121iE / MT8150iE*

MT-XE *MT8121XE / MT8150XE*

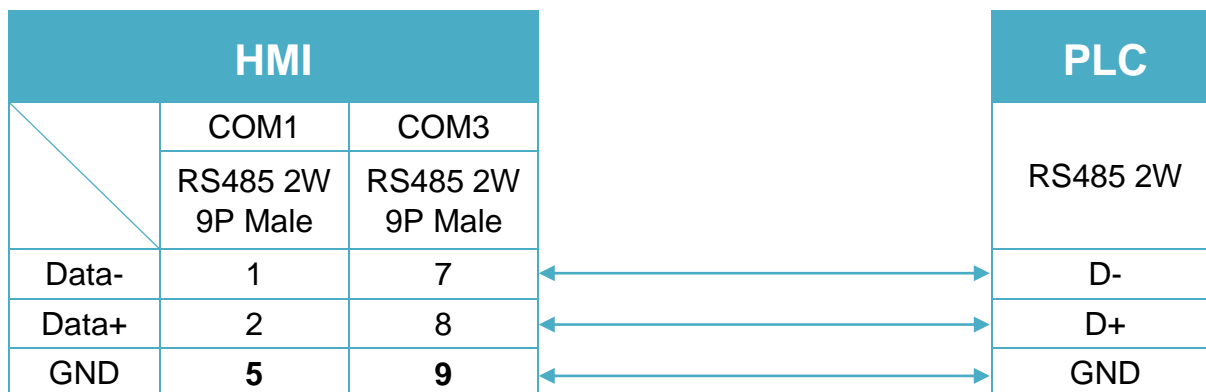


Diagram 11

MT-iE *MT8071iE / MT6071iE / MT8072iE / MT6072iE / MT8073iE /
MT8101iE / MT8102iE / MT8103iE*

MT-XE *MT8090XE / MT8092XE*

MT-iP *MT6103iP*

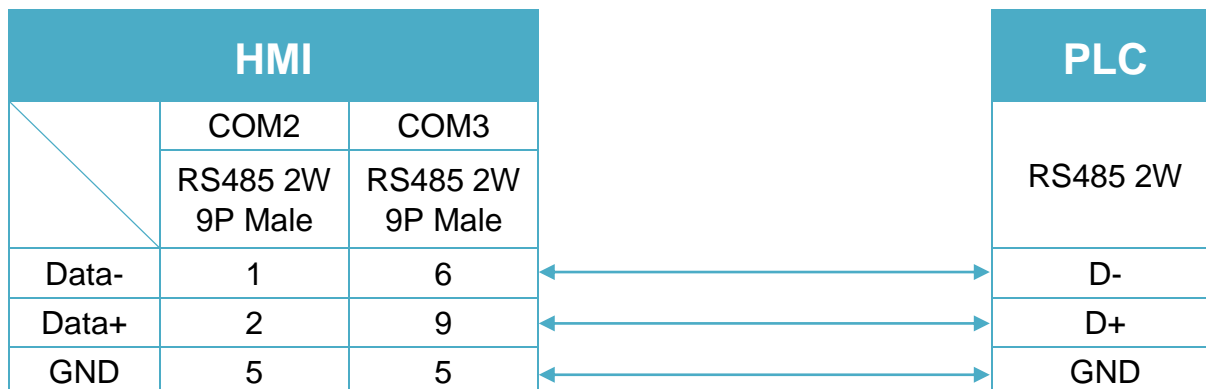


Diagram 12

MT-iE ***MT8050iE***

MT-iP ***MT6051iP***

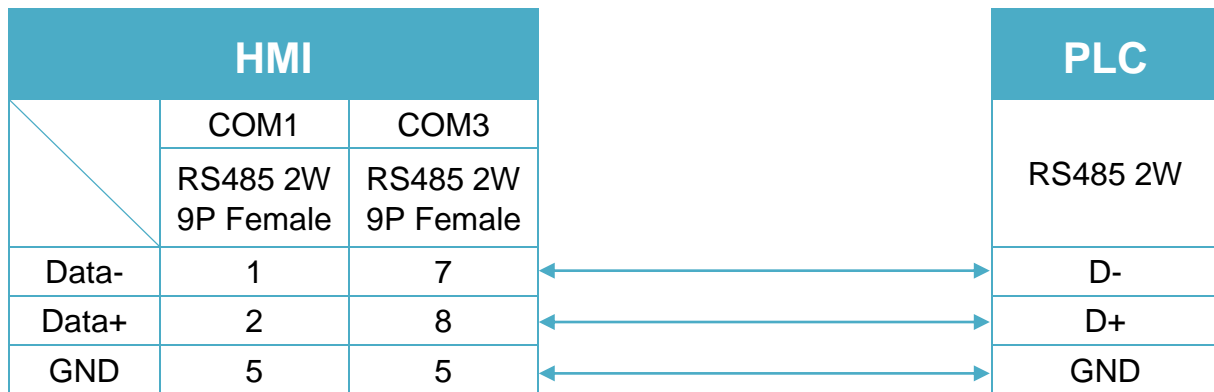


Diagram 13

MT-iP ***MT6071iP / MT8071iP***



MODBUS Server (COM/Ethernet)

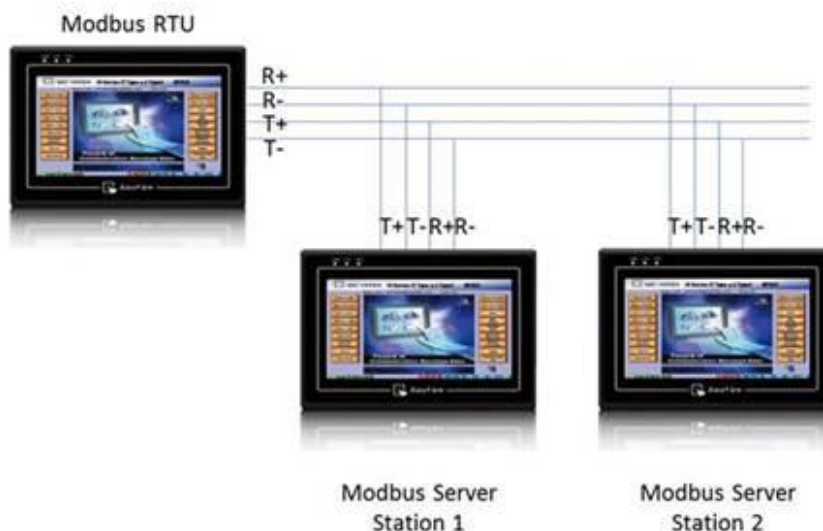
HMI Setting:

Parameters	Recommended	Options	Notes
PLC type	MODBUS Server (COM/Ethernet)		
PLC I/F	RS232	RS232, RS485	
Baud rate	9600	9600~115200 Ethernet	Ethernet supports UDP or TCP/IP protocol
Data bits	8	8	
Parity	Even	Even, Odd,	
Stop bits	1	1	
PLC sta. no.	1	1-31	HMI Modbus Station No.
Port no.		502	

Online simulator	YES	Extend address mode	NO
Broadcast command	NO		



If HMI is Modbus Server, connecting two or more Modbus Servers with one Modbus RTU via RS485 4W is not supported. To do so, use RS485 2W instead.



PLC Setting:

Communication mode	Modbus RTU protocol
---------------------------	---------------------

Modbus Server UDP Protocol Setting:

MODBUS Server (Ethernet) supports UDP communication protocol. To use UDP mode, go to [System Parameter Settings] in editing software, in [Device list] click [New], for [PLC type] select “Modbus Server”, [PLC I/F] set to [Ethernet], and select [Use UDP (User Datagram Protocol)] to finish setting.

Device Properties

Name : MODBUS Server

HMI PLC

Location : Local

1. PLC type : MODBUS Server

2. V.1.00, MODBUS_SERVER.so

PLC I/F : Ethernet

IP : Port = 502

3. Use UDP (User Datagram Protocol)

Station no. : 1

Use broadcast command

Interval of block pack (words) : 5

Max. read-command size (words) : 120

Max. write-command size (words) : 120

Modbus Server Port No. can be changed by clicking [Settings].

Modbus Server Port No. can not be set identically to HMI Port No. When doing so, the warning message below will be shown requesting users to change setting.



Note:

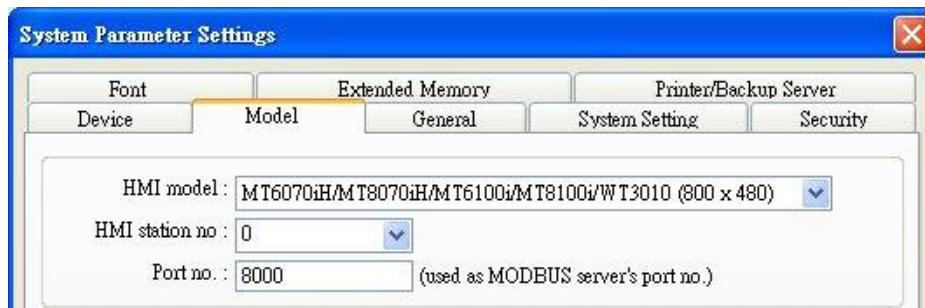
A maximum of 64 Clients can be connected simultaneously.

Modbus Server Port No. can't be identical to HMI Port No.

Modbus Server TCP/IP Protocol Setting:

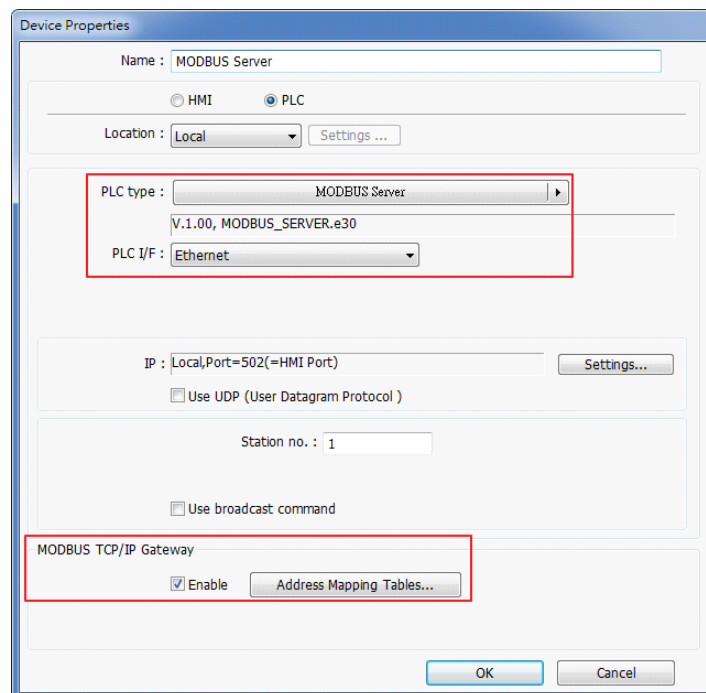
MODBUS Server (Ethernet) supports TCP/IP communication protocol. Go to [System Parameter Settings] in editing software, in [Device list] click [New], for [PLC type] select “Modbus Server”, [PLC I/F] set to [Ethernet] to finish setting.

For Modbus Server TCP/IP, HMI Port No. is the same as Modbus Server Port No. To change Port No. go to [System Parameter Settings] / [Model], the default Port No. is “8000”, and it is allowed to change Modbus Server Port No. here.



MODBUS TCP/IP Gateway:

By adding MODBUS Server with [Ethernet] interface, the [MODBUS TCP/IP Gateway] feature can be enabled by selecting the [Enable] check box.



Note the following two points when enabling the [MODBUS TCP/IP Gateway]:

- The original mapping between the MODBUS Server and the HMI address will be canceled.
- The SCADA cannot read from or write in the addresses defined in different Address Mapping Table at one time.

For more information about this, see “Chapter37 MODBUS TCP/IP Gateway”.

Table	Description	MODBUS Address		PLC Name	Mapped PLC Address	Table Size	Read/Write
1	0x <==> LB	0x-1	<==>	Local HMI	LB-0	12096 Bit(s)	Read/Write
2	1x <==> LB	1x-1	<==	Local HMI	LB-0	12096 Bit(s)	Read only
3	3x <==> LW	3x-1	<==	Local HMI	LW-0	9999 Word(s)	Read only
4	4x <==> LW	4x-1	<==>	Local HMI	LW-0	9999 Word(s)	Read/Write
5	3x <==> RW	3x-10000	<==	Local HMI	RW-0	55536 Word(s)	Read only
6	4x <==> RW	4x-10000	<==>	Local HMI	RW-0	55536 Word(s)	Read/Write

Device Address:

Bit/Word	Device type	Format	Range	Memo
B	LB	dddd	0 ~ 9998	Mapping to 0x/1x 1 ~ 9999
W	LW	dddd	0 ~ 9998	Mapping to 3x/4x 1 ~ 9999
W	RW	dddddd	0 ~ 55536	Mapping to 3x/4x 10000 ~ 65536

LB0 = 0x0001, LB1 = 0x0002, LW0 = 3x0001, LW1 = 3x0002

Modbus Server Function Code:

0x	0x01 Read coil	0x05 write single coil
0x_multi_coils	0x01 Read coil	0x0f write multiple coils
1x	0x02 Read discrete input	N/A for write operation
3x	0x04 Read input register	N/A for write operation
4x	0x03 Read holding register	0x10 write multiple registers

Modbus Server Error Code:

Error Code	Definition	Condition
01	Incorrect function code	The function code is not supported.
02	Incorrect read address	The read address is not within the range.
03	Incorrect data	The data read is incorrect, for example, the data length is 0.
251	Incorrect data	Read/Write exceeding number of words from/to the register of the Modbus device.
252	Incorrect data	Modbus device replies incorrect data format.
253	Incorrect data	Modbus device checksum error.

Wiring Diagram:

RS232 (Diagram 1 ~ Diagram 3)

Diagram 1

cMT Series	<i>cMT3151</i>
eMT Series	<i>eMT3070 / eMT3105 / eMT3120 / eMT3150</i>
MT-iE	<i>MT8073iE / MT8102iE</i>
MT-XE	<i>MT8092XE</i>
MT-iP	<i>MT6103iP</i>

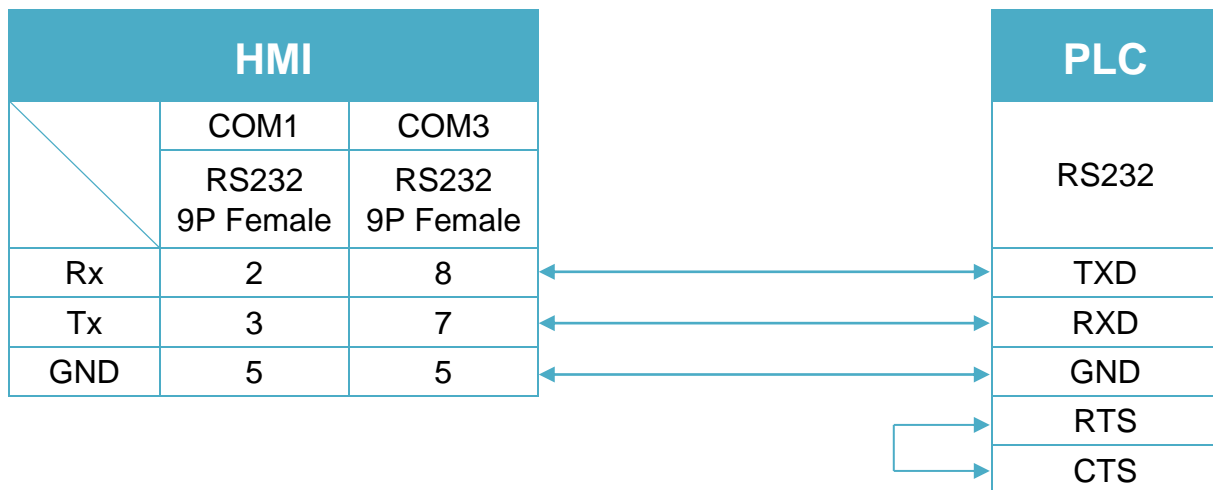


Diagram 2

cMT Series	cMT-SVR
mTV	mTV
MT-iE	MT8070iE / MT6070iE / MT8100iE / MT8121iE / MT8150iE / MT8071iE / MT6071iE / MT8072iE / MT6072iE / MT8073iE / MT8101iE / MT8102iE / MT8103iE
MT-XE	MT8121XE / MT8150XE / MT8090XE /

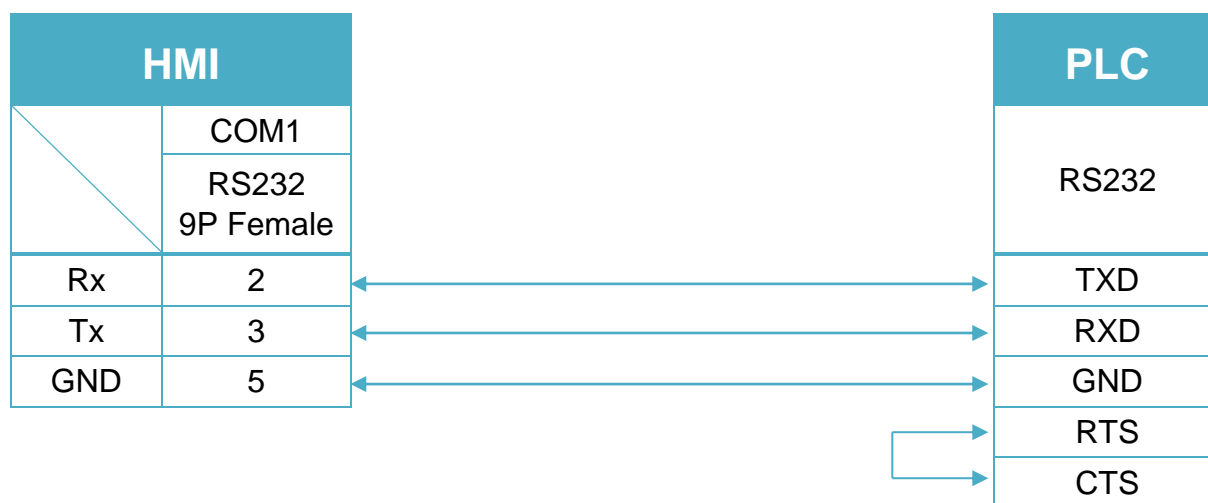
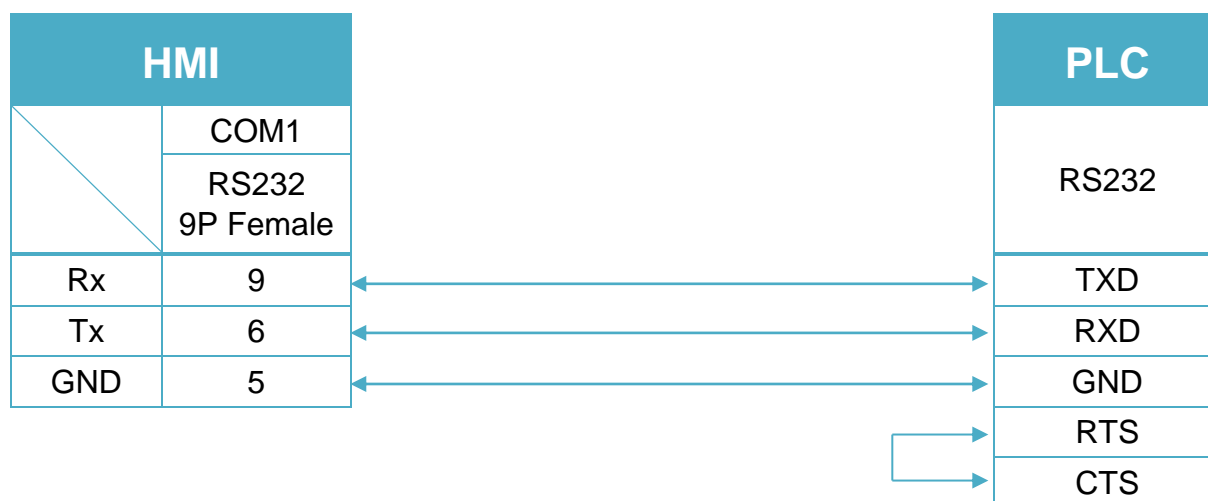


Diagram 3

MT-iE	MT8050iE
MT-iP	MT6051iP / MT6071iP / MT8071iP



RS485 4W (Diagram 4 ~ Diagram 7)

Diagram 4

cMT Series	<i>cMT3151</i>
eMT Series	<i>eMT3070 / eMT3105 / eMT3120 / eMT3150</i>
MT-iE	<i>MT8070iE / MT6070iE / MT8100iE / MT8121iE / MT8150iE</i>
MT-XE	<i>MT8121XE / MT8150XE</i>

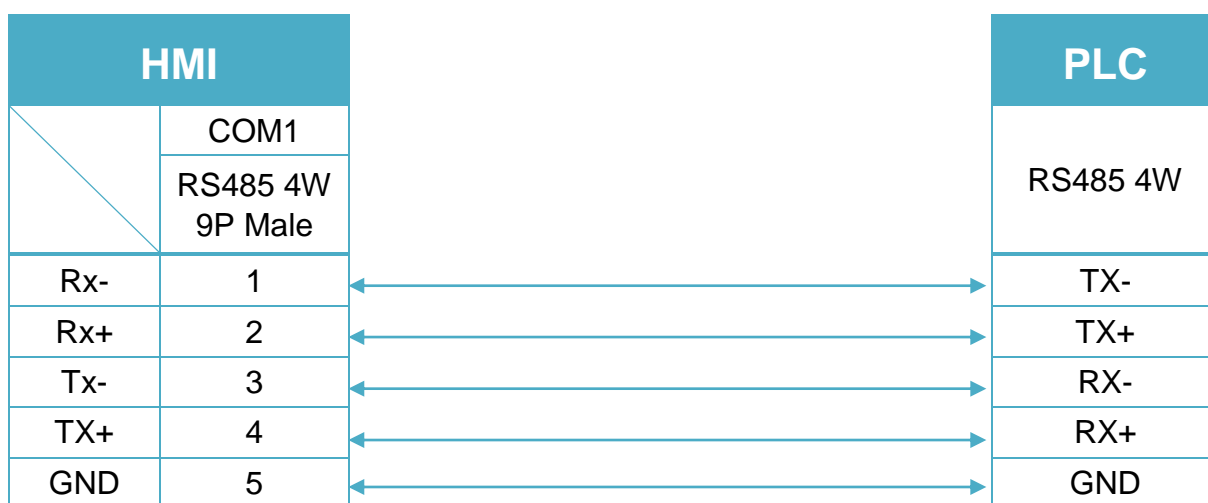


Diagram 5

cMT Series	<i>cMT-SVR</i>
mTV	<i>mTV</i>

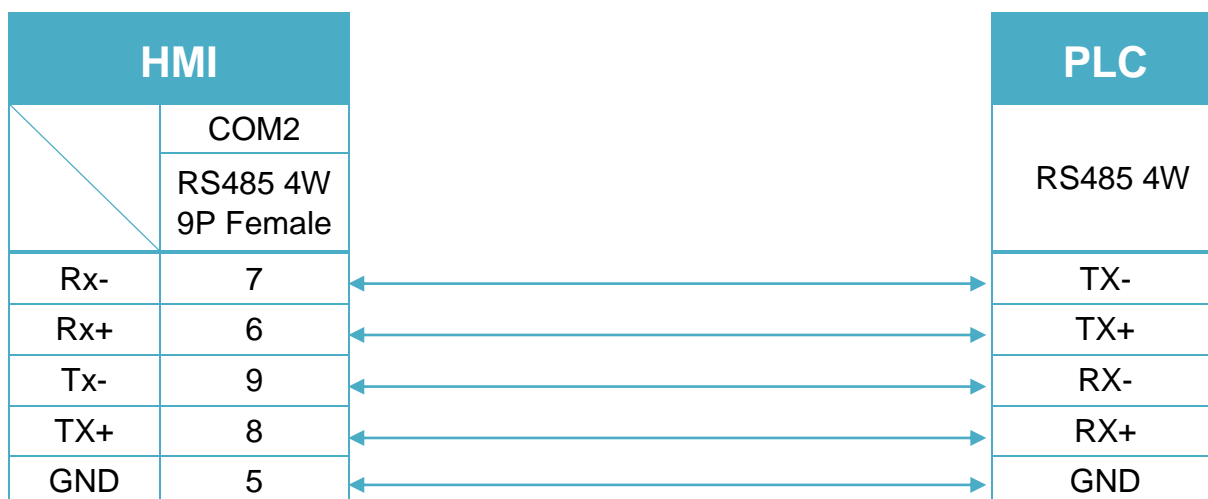


Diagram 6

MT-iE	<i>MT8071iE / MT6071iE / MT8072iE / MT6072iE / MT8073iE / MT8101iE / MT8102iE / MT8103iE</i>
MT-XE	<i>MT8090XE / MT8092XE</i>
MT-iP	<i>MT6071iP / MT8071iP / MT6103iP</i>

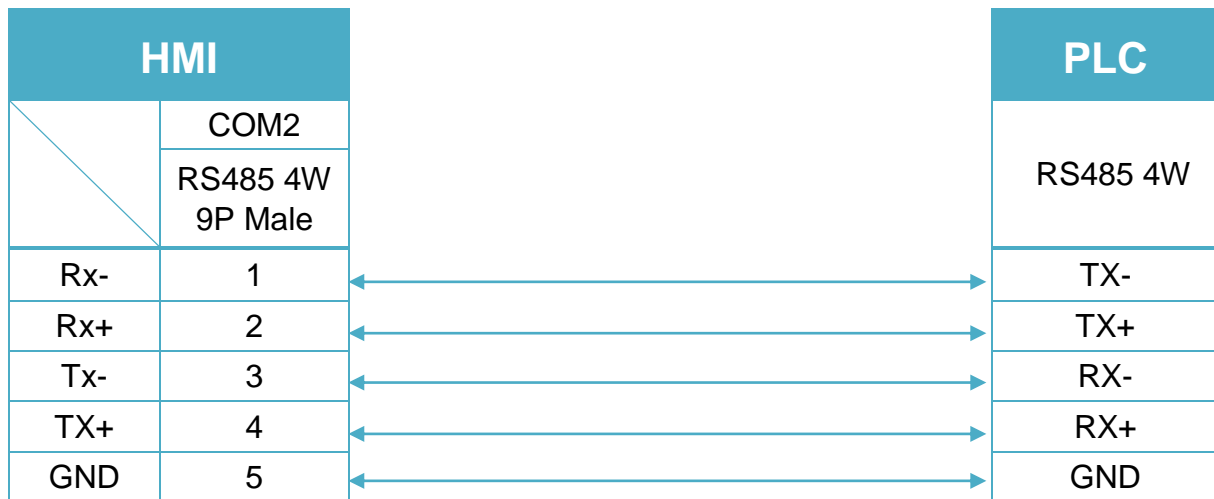
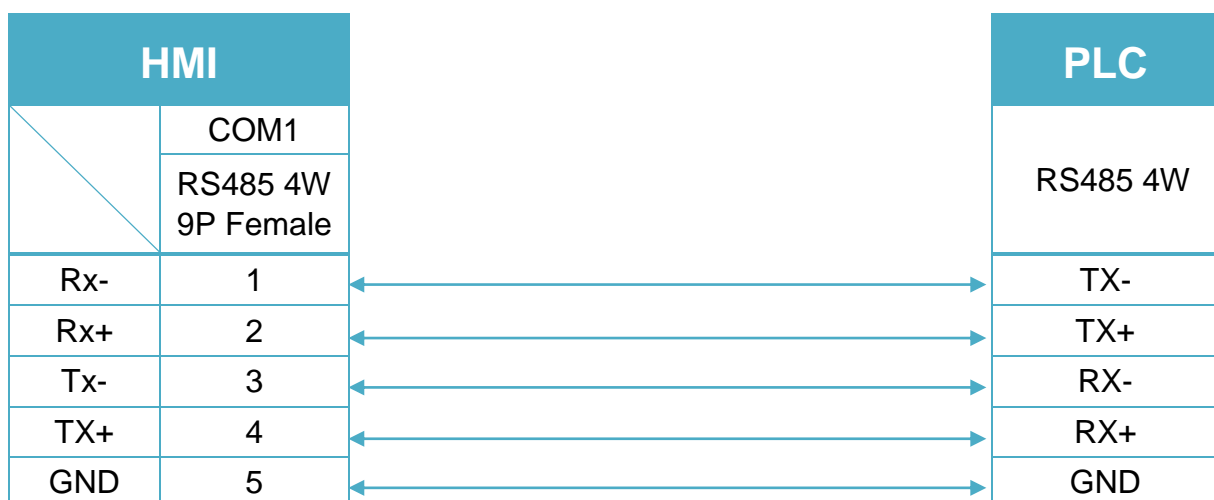


Diagram 7

MT-iE	<i>MT8050iE</i>
MT-iP	<i>MT6051iP</i>



RS485 2W (Diagram 8 ~ Diagram 13)

Diagram 8

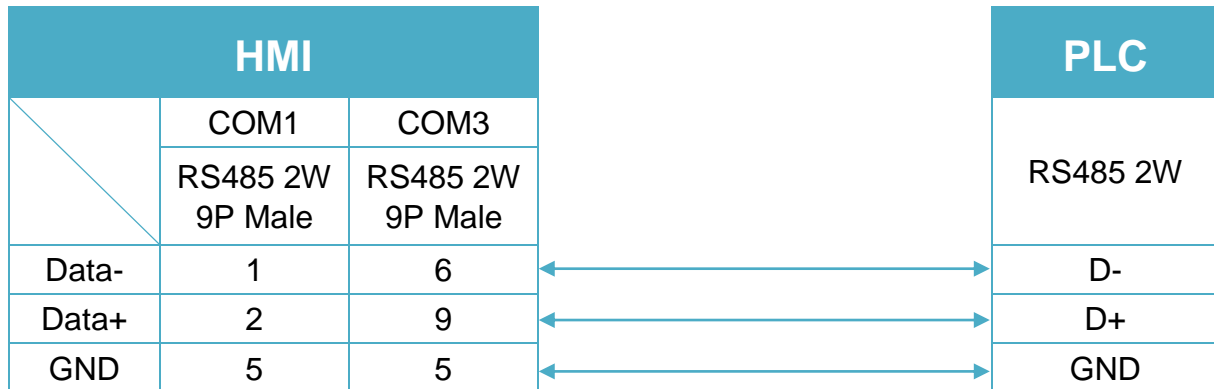
cMT Series
cMT3151
eMT Series
eMT3070 / eMT3105 / eMT3120 / eMT3150


Diagram 9

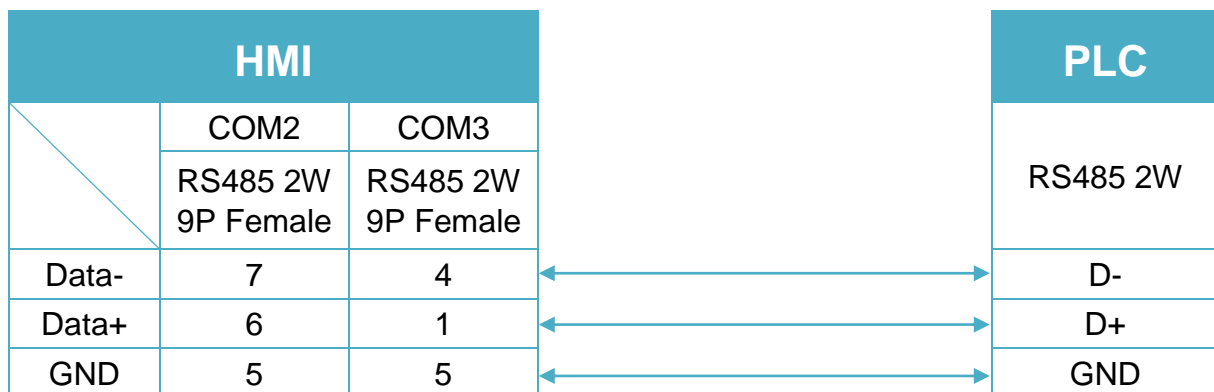
cMT Series
cMT-SVR
mTV
mTV


Diagram 10

MT-iE *MT8070iE / MT6070iE / MT8100iE / MT8121iE / MT8150iE*

MT-XE *MT8121XE / MT8150XE*

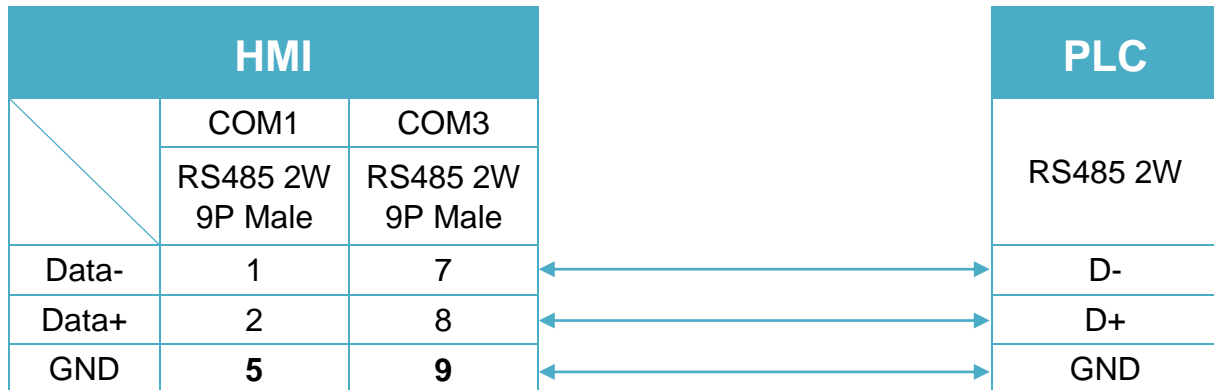


Diagram 11

MT-iE *MT8071iE / MT6071iE / MT8072iE / MT6072iE / MT8073iE /
MT8101iE / MT8102iE / MT8103iE*

MT-XE *MT8090XE / MT8092XE*

MT-iP *MT6103iP*

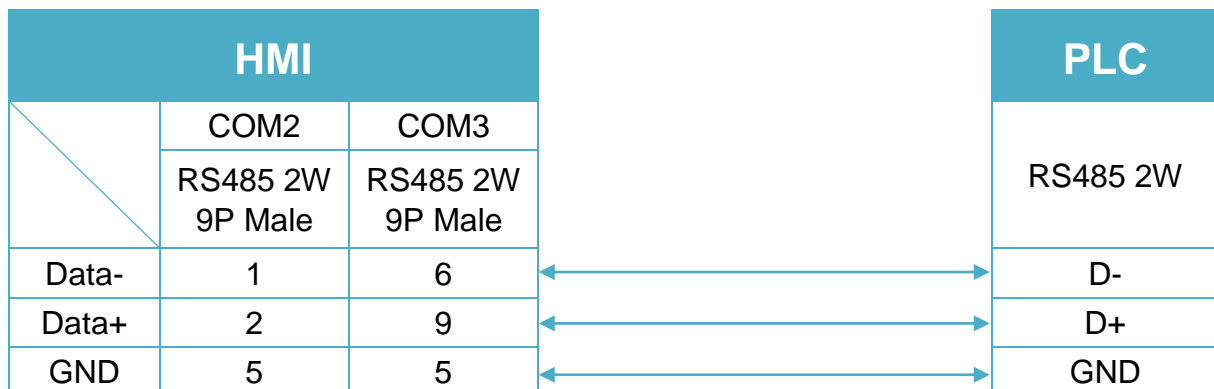


Diagram 12

MT-iE *MT8050iE*

MT-iP *MT6051iP*

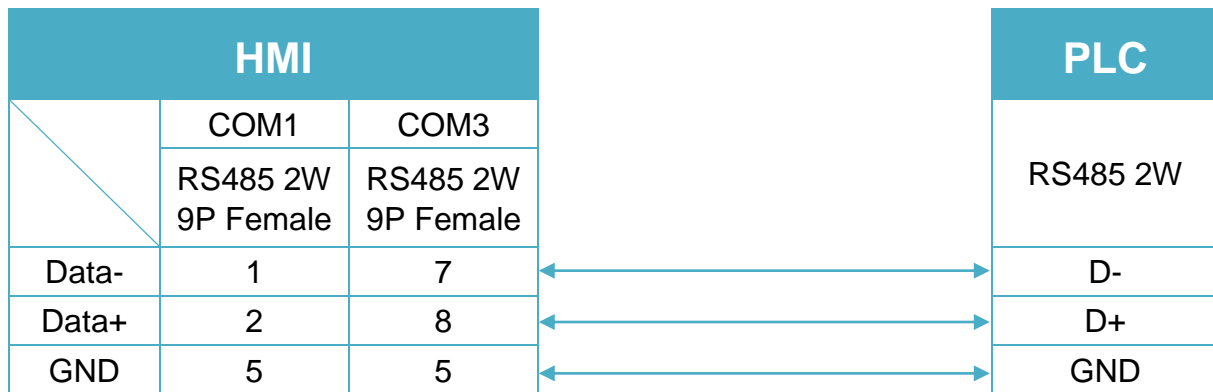
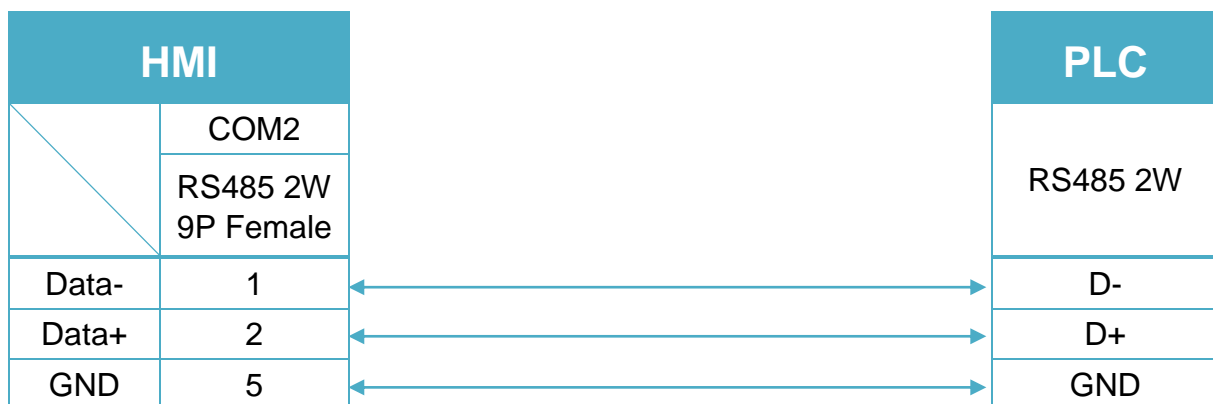


Diagram 13

MT-iP *MT6071iP / MT8071iP*



Note: Setting more than one Modbus Server in HMI Device List is of no effect.

Diagram 14

Ethernet cable:



MODBUS TCP/IP

Supported Series: Modbus RTU TCP/IP device.

Website: <http://www.modbus.org>

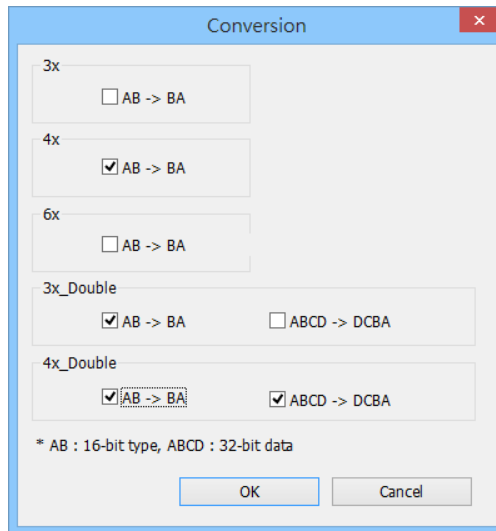
HMI Setting:

Parameters	Recommended	Options	Notes
PLC type	MODBUS TCP/IP		
PLC I/F	Ethernet		
Port no.	502		
PLC sta. no.	1	0~255	

Device Address:

Bit/Word	Device type	Format	Range	Memo
B	0x	DDDDD	1 ~ 65535	Output bit
B	1x	DDDDD	1 ~ 65535	Input bit (read only)
B	0x_single_Bit	DDDDD	1 ~ 65535	
B	1x_single_Bit	DDDDD	1 ~ 65535	
B	3x_bit	DDDDDdd	100 ~ 6553515	Input Register bit(read
B	4x_bit	DDDDDdd	100 ~ 6553515	Output Register bit
B	6x_bit	DDDDDdd	100 ~ 6553515	Output Register bit
B	0x_multi_coils	DDDDD	1 ~ 65535	Write multiple coils
W	3x	DDDDD	1 ~ 65535	Input Register
W	4x	DDDDD	1 ~ 65535	Output Register
DW	5x	DDDDD	1 ~ 65535	4x double word swap
W	6x	DDDDD	1 ~ 65535	4x single word write
DW	3x_Double	DDDDD	1 ~ 65535	*Note1
DW	4X_Double	DDDDD	1 ~ 65535	*Note1
W	4x string central europe	DDDDD	1 ~ 65535	Convert the Central Europe ASCII to Unicode.
W	4x string central europe (rev)	DDDDD	1 ~ 65535	

Note1: Go the [System Parameter Settings] -> [Device Properties] and click [Conversion] to set the data format of device types 3x, 4x, 6x, 3x_double, 4x double.



Wiring Diagram:

Diagram 1

Ethernet cable:



MODBUS TCP/IP (0x/1x Range Adjustable)

Supported Series : Modbus RTU TCP/IP device.

Website : <http://www.modbus.org>

HMI Setting:

Parameters	Recommended	Options	Notes
PLC type	MODBUS TCP/IP (0x/1x Range Adjustable)		
PLC I/F	Ethernet		
Port no.	502		
PLC sta. no.	1	0~255	

Online simulator	YES
Extend address mode	YES

Device Address:

Bit/Word	Device type	Format	Range	Memo
B	0x	DDDDD	1 ~ 65535	Output bit
B	1x	DDDDD	1 ~ 65535	Input bit (read only)
B	3x_Bit	DDDDDdd	100 ~ 6553515	Input Register bit (read only)
B	4x_Bit	DDDDDdd	100 ~ 6553515	Output Register bit
B	6x_Bit	DDDDDdd	100 ~ 6553515	Output Register bit
B	0x_multi_coils	DDDDD	1 ~ 65535	Write multiple coils
W	3x	DDDDD	1 ~ 65535	Input Register (read only)
W	4x	DDDDD	1 ~ 65535	Output Register
DW	5x	DDDDD	1 ~ 65535	4x double word swap
W	6x	DDDDD	1 ~ 65535	4x single word write
W	4x string central europe rev	DDDDD	1 ~ 65535	

NOTE:

Address type “5x” is mapping to Hold Reg. The communication protocol of “5x” is almost the same as “4x” except that “5x” swaps double words.

If 4x contains the following information:

Address	1	2	3	4	5	6	...
Data in word	0x1	0x2	0x3	0x4	0x5	0x6	
Data	0x0201		0x0403		0x0605		

For 5x, it will be:

Address	1	2	3	4	5	6	...
Data in word	0x1	0x2	0x3	0x4	0x5	0x6	
Data	0x0102		0x0304		0x0506		

Modbus RTU function code:

0x	0x01	Read coil	0x05	Write single coil
0x_multi_coils	0x01	Read coil	0x0f	Write multiple coils
1x	0x02	Read discrete input		N/A for writing operation
3x	0x04	Read input register		N/A for writing operation
4x	0x03	Read holding register	0x10	Write multiple registers
5x	0x03	Read holding register	0x10	Write multiple registers

(Note: reverse word order in double words format)


3xbit is equivalent to 3x

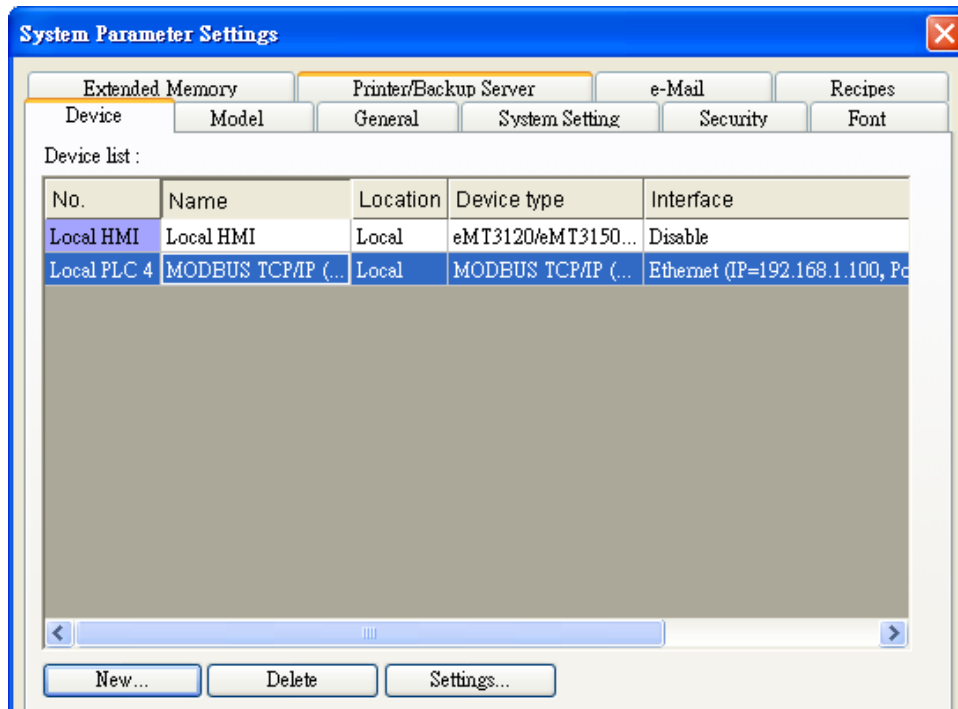
4xbit is equivalent to 4x

6x	0x03	Read holding register	0x06	Write single register
----	------	-----------------------	------	-----------------------

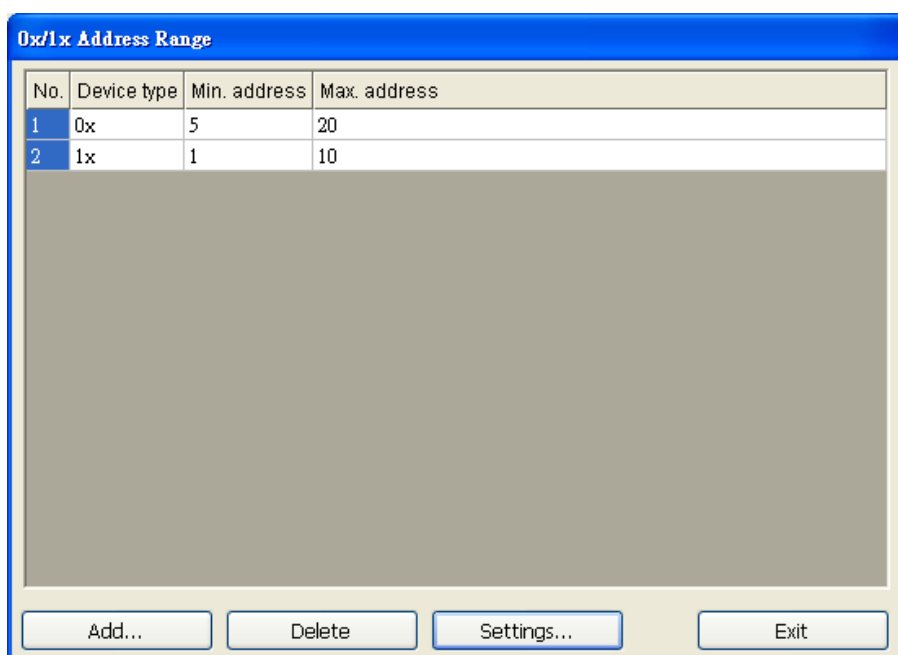
(Note: 6x is limited to device of one word only)

Setting Instructions:

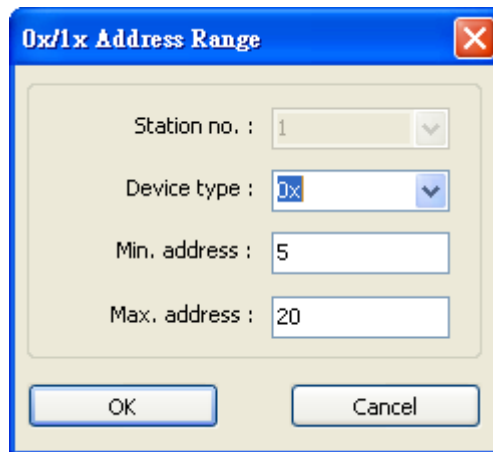
- Go to [System Parameter Settings]  , click [New] to add a new device -MODBUS TCP/IP (0x/1x Range Adjustable) , as shown below:



- Click [Add Address Range Limit] button, Users can define 0x and 1x address range in [0x 1x Address Range] dialog box, referring to bit range of the device used.



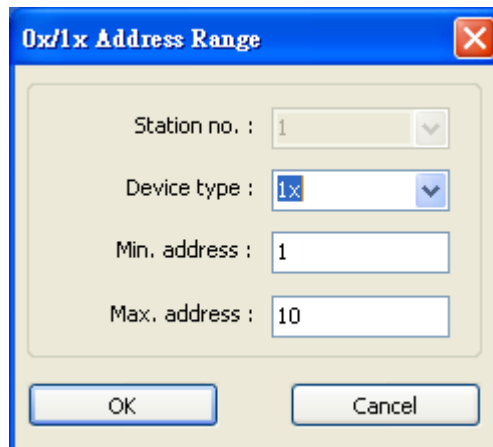
Add : Set [Station No.], [Device Type], [Max. Address] then click [OK] to finish adding as below:



The screenshot shows a dialog box titled "0x/1x Address Range" with a close button (X) in the top right corner. The dialog contains four input fields and two buttons at the bottom. The "Station no." field is a dropdown menu set to "1". The "Device type" field is a dropdown menu set to "0x". The "Min. address" field is a text box containing "5". The "Max. address" field is a text box containing "20". At the bottom, there are "OK" and "Cancel" buttons.

Delete : The selected items will be deleted.

Settings : Set [Station No.], [Device Type], [Max. Address] then click [OK] to finish adding as below:



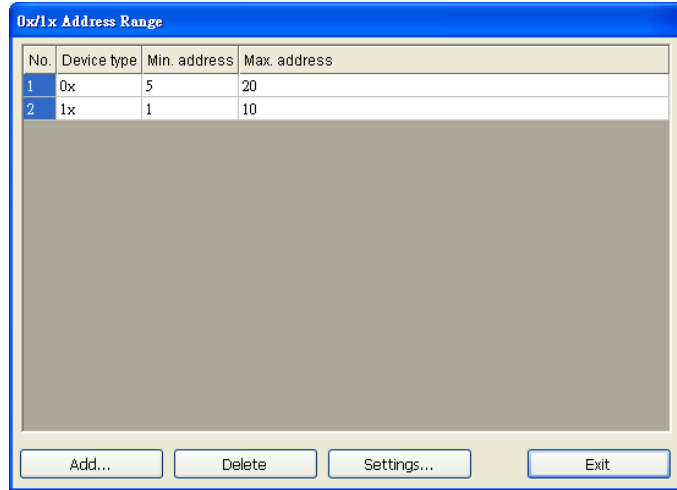
The screenshot shows a dialog box titled "0x/1x Address Range" with a close button (X) in the top right corner. The dialog contains four input fields and two buttons at the bottom. The "Station no." field is a dropdown menu set to "1". The "Device type" field is a dropdown menu set to "1x". The "Min. address" field is a text box containing "1". The "Max. address" field is a text box containing "10". At the bottom, there are "OK" and "Cancel" buttons.

Example :

Take 0x and 1x as example, the settings depend on bit range of different PLC types.

For 0x, [Device Type] **0x**, [Min. Address]**5**,[Max. Address] **20**.

For 1x, [Device Type] **0x**, [Min. Address]**1**,[Max. Address] **10**.



After completing all settings above, the communication is enabled.

Wiring Diagram:

Diagram 1

Ethernet cable:



MODBUS TCP/IP 32Bit

Supported Series: Modbus RTU TCP/IP device.

Website: <http://www.modbus.org>

HMI Setting:

Parameters	Recommended	Options	Notes
PLC type	MODBUS TCP/IP 32Bit		
PLC I/F	Ethernet		
Port no.	502		
PLC sta. no.	1	0~255	

Device Address:

Bit/Word	Device type	Format	Range	Memo
B	0x	DDDDD	1 ~ 65535	Output bit
B	1x	DDDDD	1 ~ 65535	Input bit (read only)
B	3x_Bit	DDDDDdd	100 ~ 6553515	Input Register bit (read only)
B	4x_Bit	DDDDDdd	100 ~ 6553515	Output Register bit
B	6x_Bit	DDDDDdd	100 ~ 6553515	Output Register bit
B	0x_multi_coils	DDDDD	1 ~ 65535	Write multiple coils
W	3x	DDDDD	1 ~ 65535	Input Register
W	4x	DDDDD	1 ~ 65535	Output Register
DW	5x	DDDDD	1 ~ 65535	4x double word swap
W	6x	DDDDD	1 ~ 65535	4x single word write
W	4x_32Bit*	DDDDD	1 ~ 65535	

4x_32Bit will only read / write 2 words for each package, for continuous addresses, it will be divided into several packages.

Wiring Diagram:

Ethernet cable:



Moeller XC-CPU101

Supported Series: MOELLER XC100/200 series

Website: <http://www.moeller.net>

HMI Setting:

Parameters	Recommended	Options	Notes
PLC type	Moeller XC-CPU101		
PLC I/F	RS232		
Baud rate	38400	4800 ~ 57600	
Data bits	8		
Parity	None		
Stop bits	1		
PLC sta. no.	1		

Device Address:

Bit/Word	Device type	Format	Range	Note
B	IX	DDo	0 ~ 157	
B	QX	DDo	0 ~ 157	
B	MX	DDDDo	0 ~ 40957	
W	IW	DD	0 ~ 15	
W	QW	DD	0 ~ 15	
W	MW	DDDD	0 ~ 4095	

Wiring Diagram:

Diagram 1

cMT Series	<i>cMT3151</i>
eMT Series	<i>eMT3070 / eMT3105 / eMT3120 / eMT3150</i>
MT-iE	<i>MT8073iE / MT8102iE</i>
MT-XE	<i>MT8092XE</i>
MT-iP	<i>MT6103iP</i>

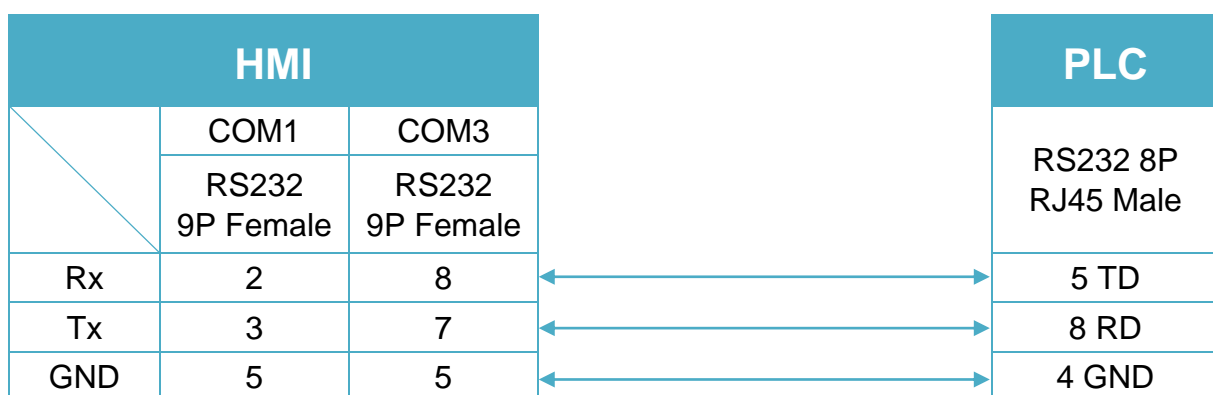


Diagram 2

cMT Series	<i>cMT-SVR</i>
mTV	<i>mTV</i>
MT-iE	<i>MT8070iE / MT6070iE / MT8100iE / MT8121iE / MT8150iE / MT8071iE / MT6071iE / MT8072iE / MT6072iE / MT8073iE / MT8101iE / MT8102iE / MT8103iE</i>
MT-XE	<i>MT8121XE / MT8150XE / MT8090XE /</i>

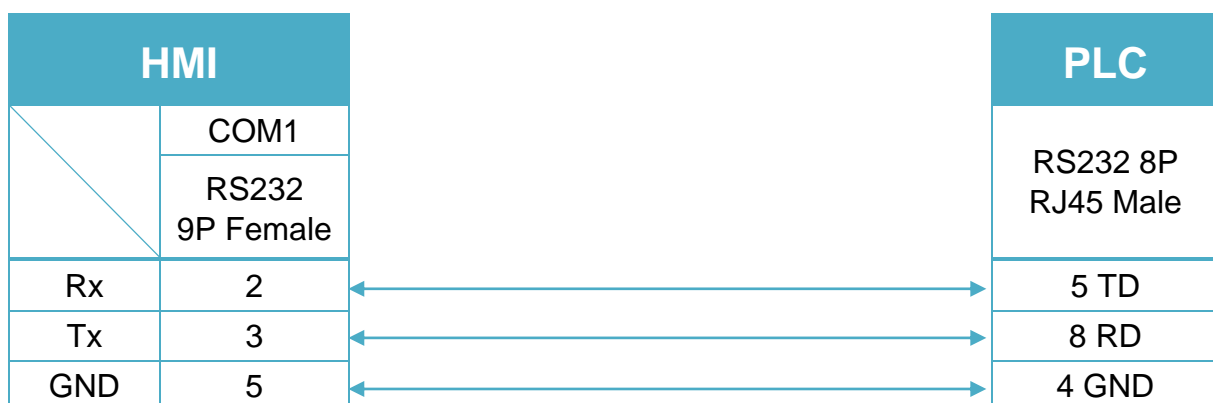


Diagram 3

MT-iE
MT8050iE
MT-iP
MT6051iP / MT6071iP / MT8071iP


motrona BY-340

Supported Series: motrona BY-340

Website: <http://motrona.net/index.html>

HMI Setting:

Parameters	Recommended	Options	Notes
PLC type	motrona BY-340		
PLC I/F	RS232		
Baud rate	9600	1200 ~ 38400	
Data bits	7	7,8	
Parity	Even	Even, Odd, None	
Stop bits	1	1,2	
PLC sta. no.	11	11 ~ 99	

Device Address:

Bit/Word	Device type	Format	Range	Note
B	Reset	D	0	
B	Trim-	D	0	
B	Trim+	D	0	
B	Activate Data	D	0	
B	Integrator off	D	0	
B	Store EEPROM	D	0	
B	Scroll Display	D	0	
B	Keyboard Disable	D	0	
B	Clear Min. & Max.	D	0	
B	Read front F1	D	0	
B	Stop Slave	D	0	
B	Index Slave	D	0	
B	Index Master	D	0	
B	Reset Ex	D	0	
B	Trim- Ex	D	0	
B	Trim+ Ex	D	0	
B	Integrator off Ex	D	0	
B	Store EEPROM Ex	D	0	
B	Scroll Display Ex	D	0	

Bit/Word	Device type	Format	Range	Note
B	Keyboard Disable Ex	D	0	
B	Clear Min. & Max. Ex	D	0	
B	Read front F1 Ex	D	0	
B	Stop Slave Ex	D	0	
B	Index Slave Ex	D	0	
B	Index Master Ex	D	0	
B	Output Unit ready	D	0	
B	Output Led 1	D	0	
B	Output Led 2	D	0	
B	Output Status 4	D	0	
B	Output max. Frequency	D	0	
B	Output max. Correction	D	0	
B	Output Alert 2	D	0	
B	Output Alert 1	D	0	
DW	Factor 1	D	0	
DW	Factor 2	D	0	
W	Operational Mode	D	0	
W	Trim Time	D	0	
W	Integration Time	D	0	
W	Correction Divider	D	0	
DW	Factor 1 Scaling	D	0	
DW	Factor 1 Minimum	D	0	
DW	Factor 1 Maximum	D	0	
W	Sampling Time	D	0	
W	Wait Time	D	0	
DW	Max.Master Frequency	D	0	
W	Ramp Time	D	0	
W	Stop-Ramp Time	D	0	
W	Alert 1	D	0	
W	Alert 2	D	0	
DW	Phase Offset	D	0	
DW	Slave Pulses Index	D	0	
W	Phase Adjust	D	0	
W	Master Index Divider	D	0	
W	Index Window	D	0	
W	Max. Index Correction	D	0	
W	M Encoder Properties	D	0	

Bit/Word	Device type	Format	Range	Note
W	M Edge Counting	D	0	
W	M Counting Direction	D	0	
W	M Speed Display Factor	D	0	
W	M Speed Display Divider	D	0	
W	M Speed Display Dec.Point	D	0	
W	S Encoder Properties	D	0	
W	S Edge Counting	D	0	
W	S Counting Direction	D	0	
W	Analogue Format	D	0	
W	Offset Correction	D	0	
W	Gain Correction	D	0	
W	Max. Correction	D	0	
W	Offset Total	D	0	
W	Gain Total	D	0	
W	Key Up Function	D	0	
W	Key Down Function	D	0	
W	Key Enter Function	D	0	
W	Input 1 Configuration	D	0	
W	Input 1 Function	D	0	
W	Input 2 Configuration	D	0	
W	Input 2 Function	D	0	
W	Input 3 Configuration	D	0	
W	Input 3 Function	D	0	
W	Input 4 Configuration	D	0	
W	Input 4 Function	D	0	
W	Unit Number	D	0	
W	Serial Baud Rate	D	0	
W	Serial Format	D	0	
W	Input Filter	D	0	
W	Trigger Threshold 1	D	0	
W	Trigger Threshold 2	D	0	
W	Brightness	D	0	
W	Frequency Control	D	0	
W	Factor Store Config	D	0	
W	Display Time	D	0	
W	Default Display	D	0	
DW	Protect Group F01	D	0	

Bit/Word	Device type	Format	Range	Note
DW	Protect Group F02	D	0	
DW	Protect Group F03	D	0	
DW	Protect Group F04	D	0	
DW	Protect Group F05	D	0	
DW	Protect Group F06	D	0	
DW	Protect Group F07	D	0	
DW	Protect Group F08	D	0	
DW	Protect Group F09	D	0	
DW	test value	D	0	
DW	Differential_Counter	D	0	
DW	Diff_Counter_nodiv	D	0	
DW	ana_voltate	D	0	
DW	new_Counter_Master	D	0	
DW	new_Counter_Slave	D	0	
DW	frequency_a/10	D	0	
DW	scal_F1	D	0	
DW	Index_Buffer_Master	D	0	
DW	Index_Buffer_Slave	D	0	
DW	Index_Status	D	0	
DW	Counter_Master	D	0	
DW	Counter_Slave	D	0	
DW	Master_Index_Counter	D	0	
DW	Phase_Counter_Slave	D	0	
DW	Phase_Corr_Buffer	D	0	
DW	Trim_Phase	D	0	
DW	Index_Pulses_Master	D	0	
DW	Index_Pulses_Slave	D	0	
DW	Loop_time	D	0	
DW	Test_Variable	D	0	
DW	Base_Ram	D	0	

Wiring Diagram:

Diagram 1

cMT Series	<i>cMT3151</i>
eMT Series	<i>eMT3070 / eMT3105 / eMT3120 / eMT3150</i>
MT-iE	<i>MT8073iE / MT8102iE</i>
MT-XE	<i>MT8092XE</i>
MT-iP	<i>MT6103iP</i>

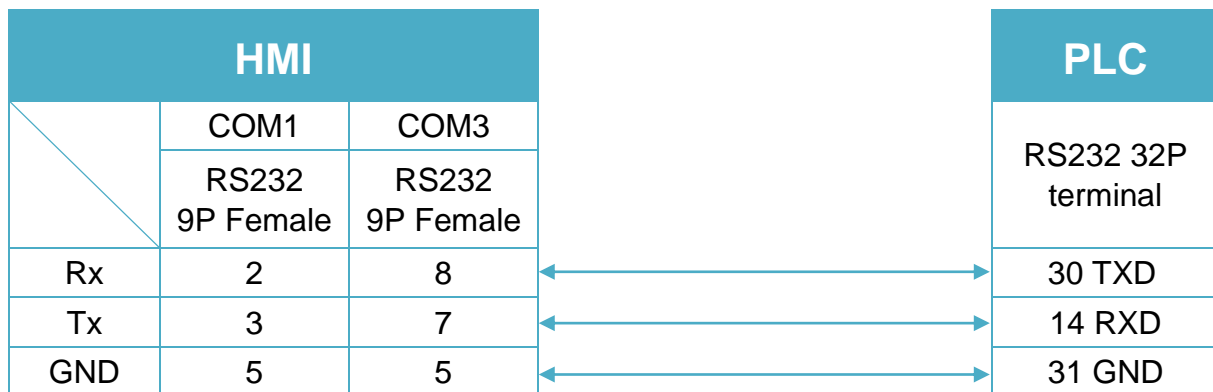


Diagram 2

cMT Series	<i>cMT-SVR</i>
mTV	<i>mTV</i>
MT-iE	<i>MT8070iE / MT6070iE / MT8100iE / MT8121iE / MT8150iE / MT8071iE / MT6071iE / MT8072iE / MT6072iE / MT8073iE / MT8101iE / MT8102iE / MT8103iE</i>
MT-XE	<i>MT8121XE / MT8150XE / MT8090XE /</i>

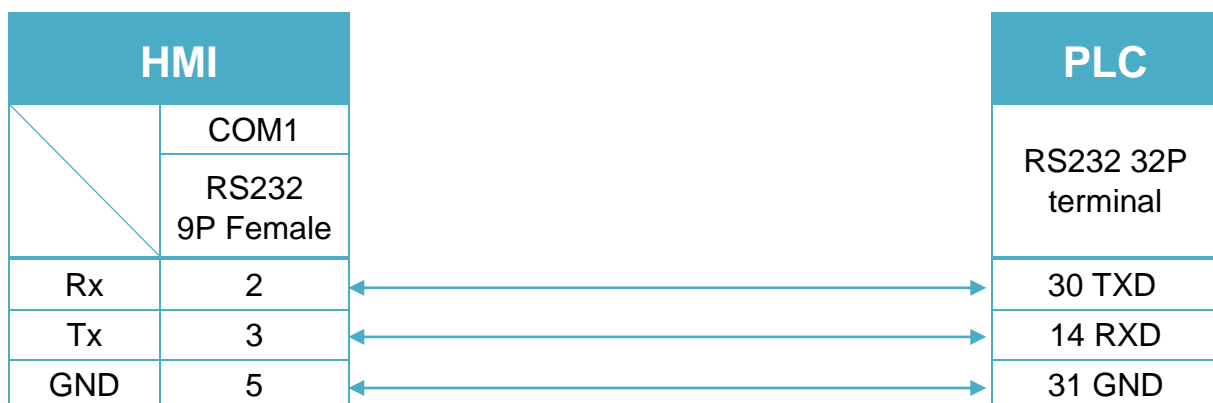


Diagram 3

MT-iE
MT8050iE
MT-iP
MT6051iP / MT6071iP / MT8071iP


motrona CT-150

Supported Series: motrona CT-150

Website: <http://motrona.net/index.html>

HMI Setting:

Parameters	Recommended	Options	Notes
PLC type	motrona CT-150		
PLC I/F	RS232	RS232/RS485	
Baud rate	9600	1200 ~ 38400	
Data bits	7	7,8	
Parity	Even	Even,Odd,None	
Stop bits	1	1,2	
PLC sta. no.	11	11 ~ 99	The station number must not contain 0.

Device Address:

Bit/Word	Device type	Format	Range	Note
W	An	D	4 ~ 8	
W	Bn	D	1 ~ 9	
W	Cn	DD	0 ~ 99	
W	An_32Bit	D	4 ~ 8	
W	Bn_32Bit	D	1 ~ 9	
W	Cn_32Bit	DD	0 ~ 99	
W	ERR_CNT	D	0	
W	LV_VAL	D	0	
W	PRTMARK_ERR	D	0	
W	BAT_CNT	D	0	
W	WASTE_CNT	D	0	
W	LINE_SPD	D	0	
W	ACT_CUT_LEN	D	0	
W	ACT_CUT_ERR_M	D	0	
W	ACT_CUT_ERR_L	D	0	

Wiring Diagram:

Diagram 1

cMT Series	<i>cMT3151</i>
eMT Series	<i>eMT3070 / eMT3105 / eMT3120 / eMT3150</i>
MT-iE	<i>MT8073iE / MT8102iE</i>
MT-XE	<i>MT8092XE</i>
MT-iP	<i>MT6103iP</i>

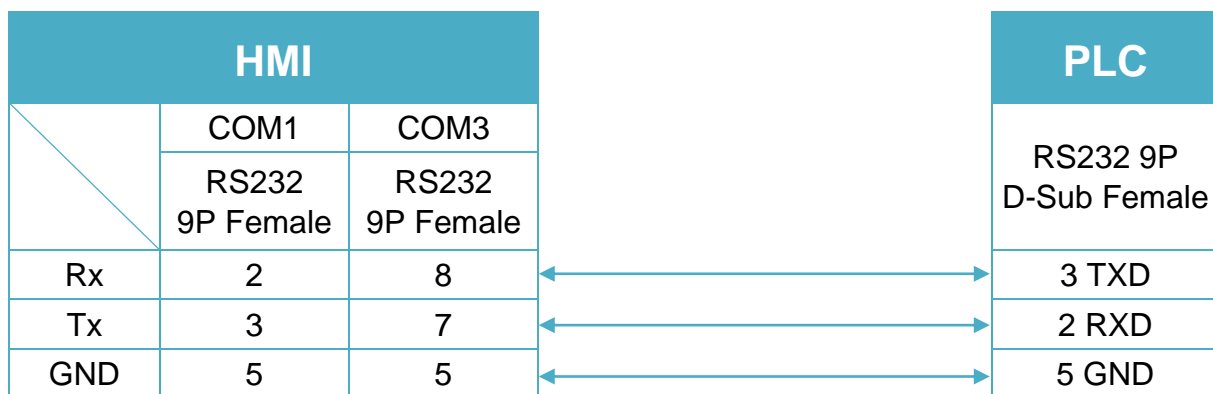


Diagram 2

cMT Series	<i>cMT-SVR</i>
mTV	<i>mTV</i>
MT-iE	<i>MT8070iE / MT6070iE / MT8100iE / MT8121iE / MT8150iE / MT8071iE / MT6071iE / MT8072iE / MT6072iE / MT8073iE / MT8101iE / MT8102iE / MT8103iE</i>
MT-XE	<i>MT8121XE / MT8150XE / MT8090XE /</i>

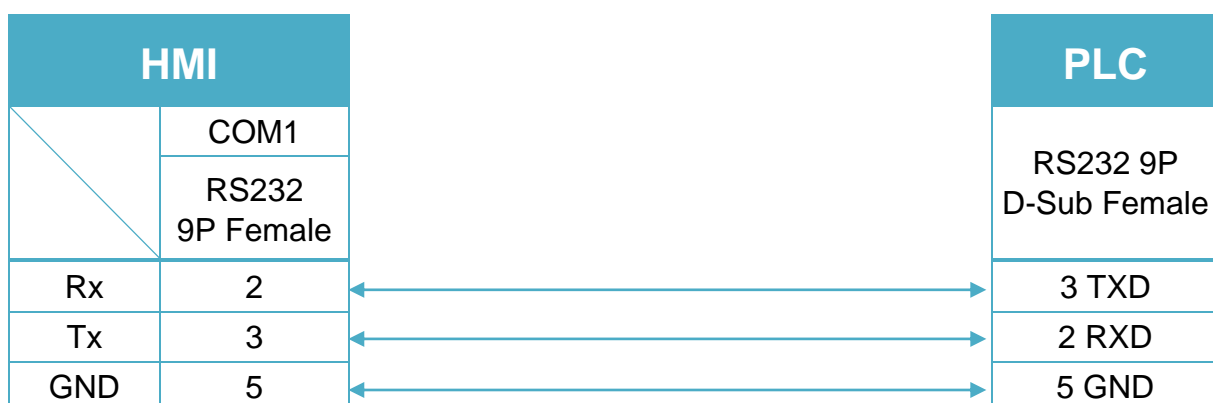


Diagram 3

MT-iE
MT8050iE
MT-iP
MT6051iP / MT6071iP / MT8071iP


motrona CT15012B

Supported Series: motrona CT15012B

Website: <http://motrona.net/index.html>

HMI Setting:

Parameters	Recommended	Options	Notes
PLC type	motrona CT15012B		
PLC I/F	RS232		
Baud rate	9600		
Data bits	7		
Parity	Even		
Stop bits	1		
PLC sta. no.	11		

Device Address:

Bit/Word	Device type	Format	Range	Note
W	Cn	DD	0 ~ 99	

Wiring Diagram:

Diagram 1

cMT Series	<i>cMT3151</i>
eMT Series	<i>eMT3070 / eMT3105 / eMT3120 / eMT3150</i>
MT-iE	<i>MT8073iE / MT8102iE</i>
MT-XE	<i>MT8092XE</i>
MT-iP	<i>MT6103iP</i>

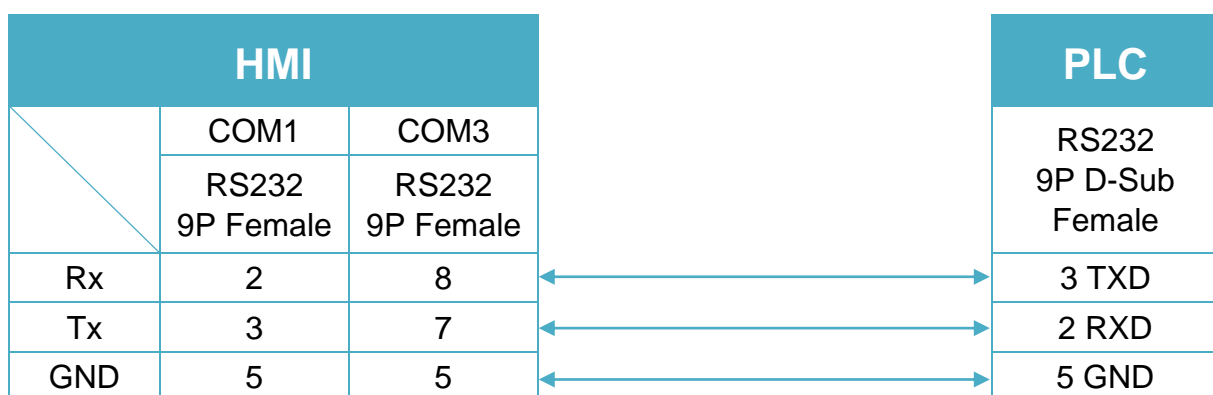


Diagram 2

cMT Series	<i>cMT-SVR</i>
mTV	<i>mTV</i>
MT-iE	<i>MT8070iE / MT6070iE / MT8100iE / MT8121iE / MT8150iE / MT8071iE / MT6071iE / MT8072iE / MT6072iE / MT8073iE / MT8101iE / MT8102iE / MT8103iE</i>
MT-XE	<i>MT8121XE / MT8150XE / MT8090XE /</i>

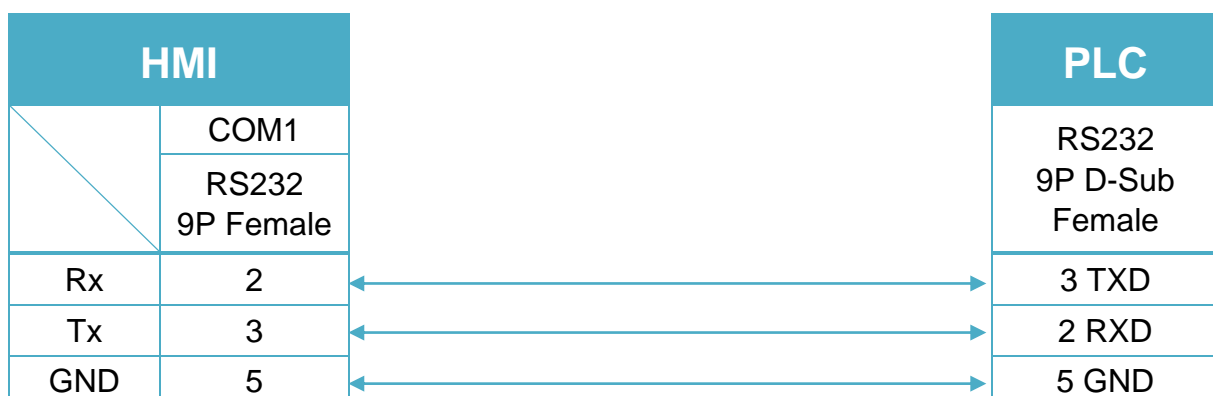
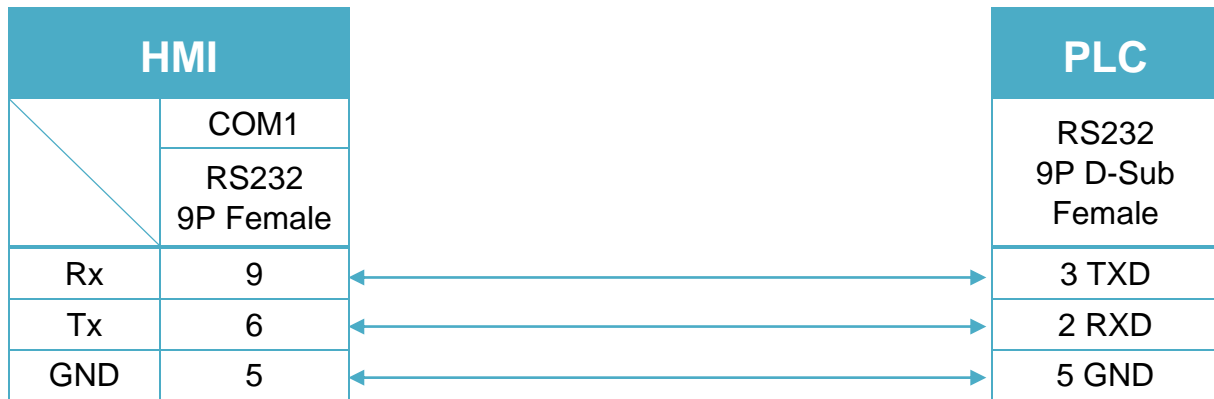


Diagram 3

MT-iE
MT8050iE
MT-iP
MT6051iP / MT6071iP / MT8071iP


motrona MC700

Supported Series: motrona MC700

Website: <http://motrona.net/index.html>

HMI Setting:

Parameters	Recommended	Options	Notes
PLC type	motrona MC700		
PLC I/F	RS232		
Baud rate	9600	9600 ~ 38400	
Data bits	7	7, 8	
Parity	Even	Even, Odd, None	
Stop bits	1	1, 2	
PLC sta. no.	11	11 ~ 99	

Device Address:

Bit/Word	Device type	Format	Range	Note
B	ERCD_Bit	HHHH	0 ~ FFFF	
W	ERCD	HHHH	0 ~ FFFF	

Wiring Diagram:

Diagram 1

cMT Series	<i>cMT3151</i>
eMT Series	<i>eMT3070 / eMT3105 / eMT3120 / eMT3150</i>
MT-iE	<i>MT8073iE / MT8102iE</i>
MT-XE	<i>MT8092XE</i>
MT-iP	<i>MT6103iP</i>

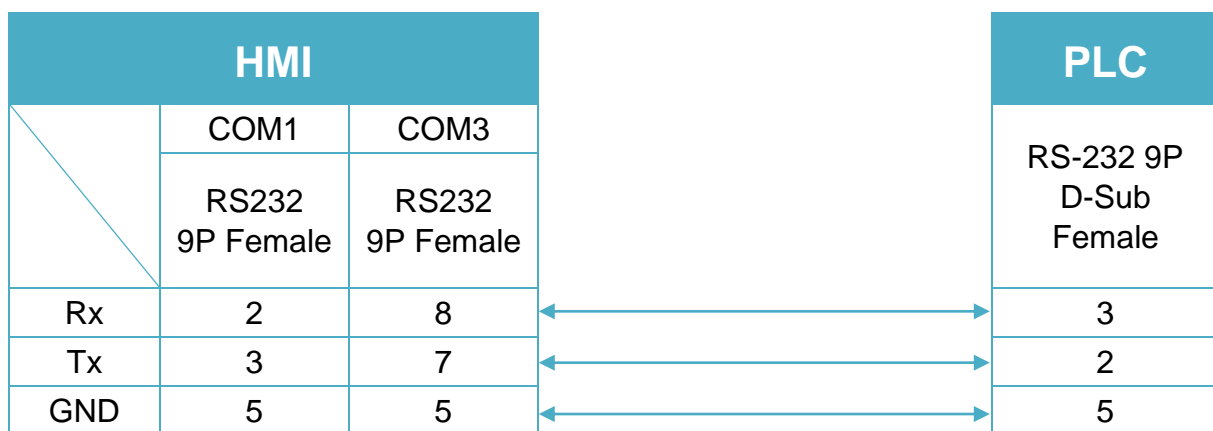


Diagram 2

cMT Series	cMT-SVR
mTV	mTV
MT-iE	MT8070iE / MT6070iE / MT8100iE / MT8121iE / MT8150iE / MT8071iE / MT6071iE / MT8072iE / MT6072iE / MT8073iE / MT8101iE / MT8102iE / MT8103iE
MT-XE	MT8121XE / MT8150XE / MT8090XE /

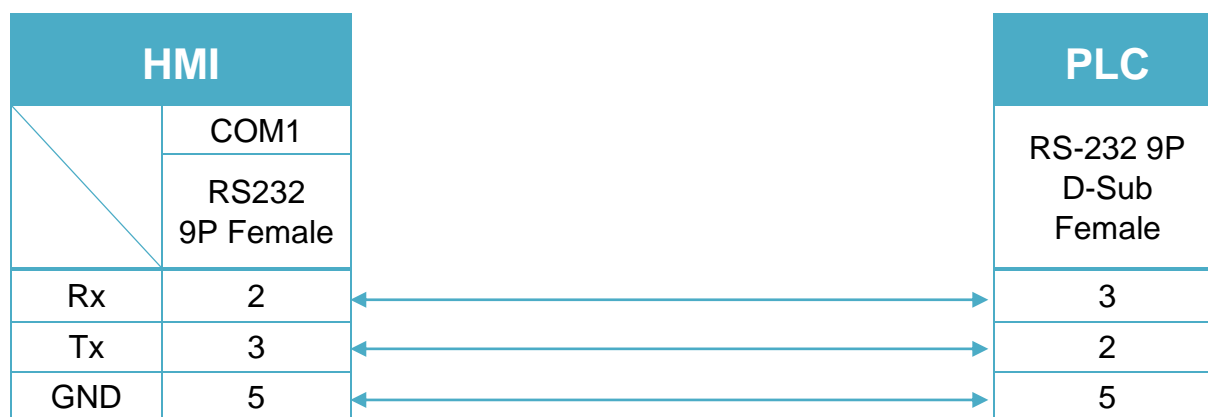
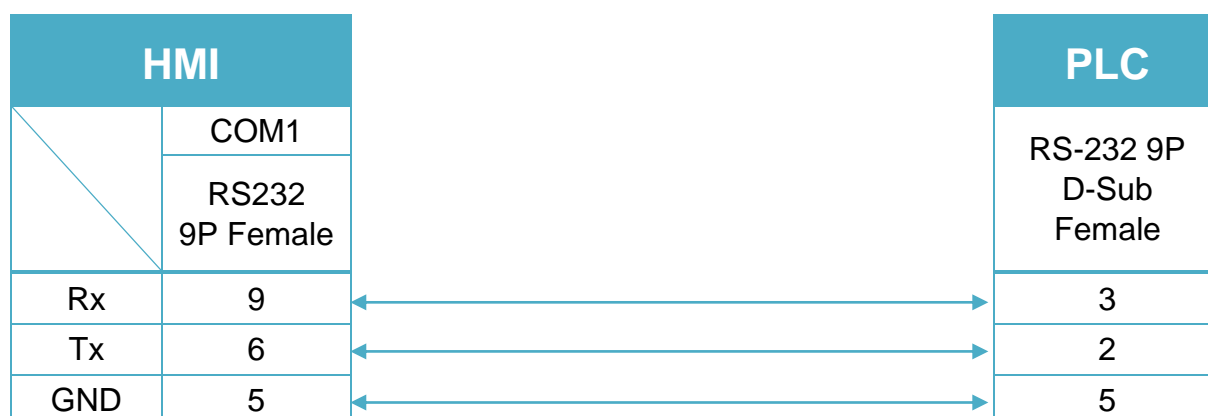


Diagram 3

MT-iE	MT8050iE
MT-iP	MT6051iP / MT6071iP / MT8071iP



MTConnect (Ethernet)

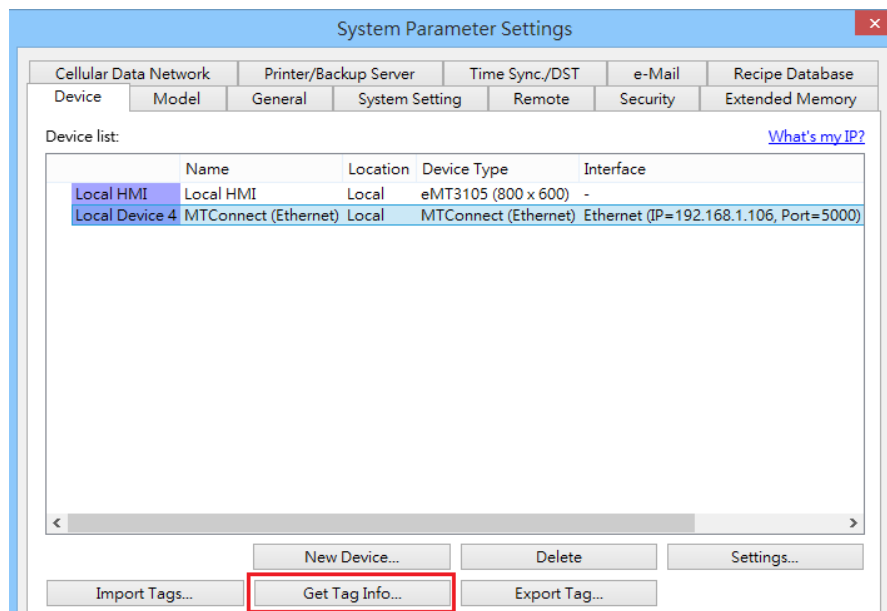
Supported Series: MTConnect protocol device

HMI Setting:

Parameters	Recommended	Options	Notes
PLC type	MTConnect (Ethernet)		
PLC I/F	Ethernet		
Port no.	5000		
Device name	Must match the PLC setting		

Online simulator	Yes
-------------------------	-----

*Click **Get Tag Info**



Support Device Type:

Data type	EasyBuilder data format	Memo
CHAR	ASCII input and display	
STRING	ASCII input and display	
DWord	32-bit BCD, Hex, Binary, Unsigned	

Wiring Diagram:

Ethernet cable:



Nanjing CIGU Controller (for i-Series only)

Website: <http://www.cigu.org.cn/>

HMI Setting:

Parameters	Recommended	Options	Notes
PLC type	Nanjing CIGU Controller		
PLC I/F	RS485 2W		
Baud rate	9600		
Data bits	8		
Parity	None		
Stop bits	1		
PLC sta. no.	1		

Device Address:

Bit/Word	Device type	Format	Range	Memo
W	4x	DDD	1 ~ 107	

Wiring Diagram:

Diagram 1

cMT Series

cMT3151

eMT Series

eMT3070/ eMT3105 / eMT3120 / eMT3150

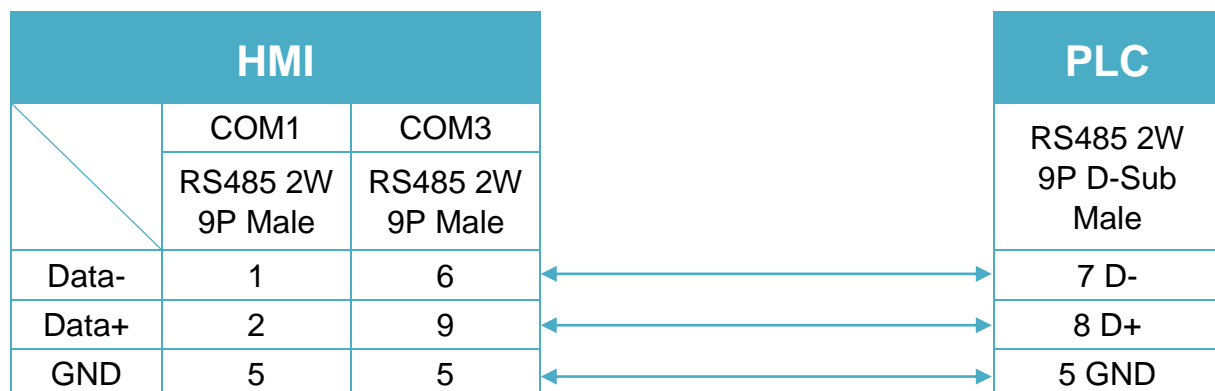


Diagram 2

cMT Series *cMT-SVR*

mTV *mTV*

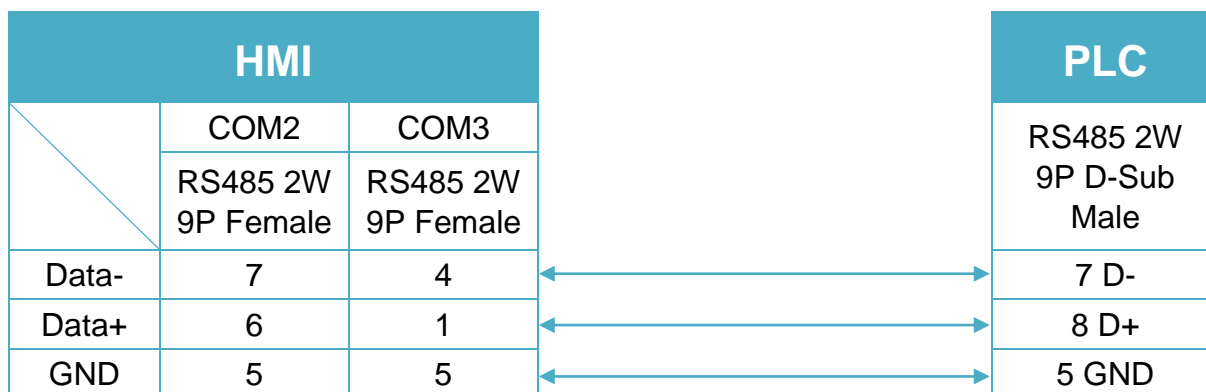


Diagram 3

MT-iE *MT8070iE / MT6070iE / MT8100iE / MT8121iE / MT8150iE*

MT-XE *MT8121XE / MT8150XE*

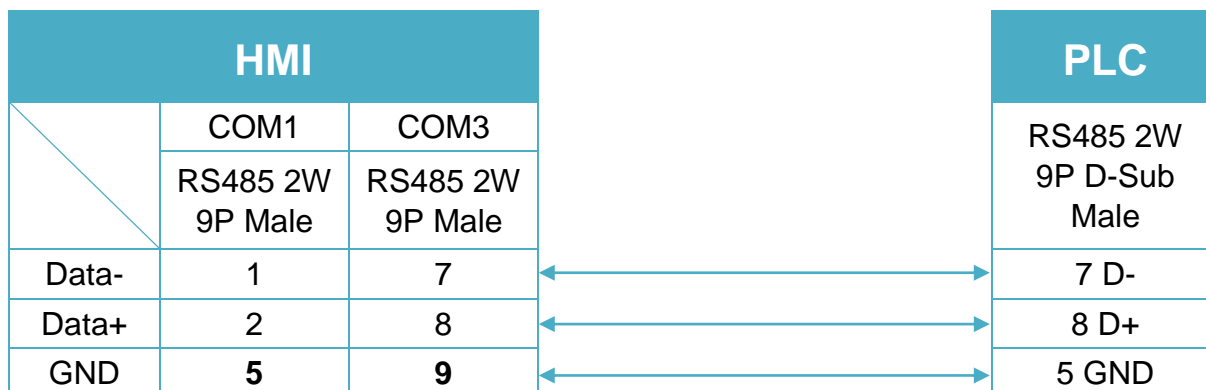
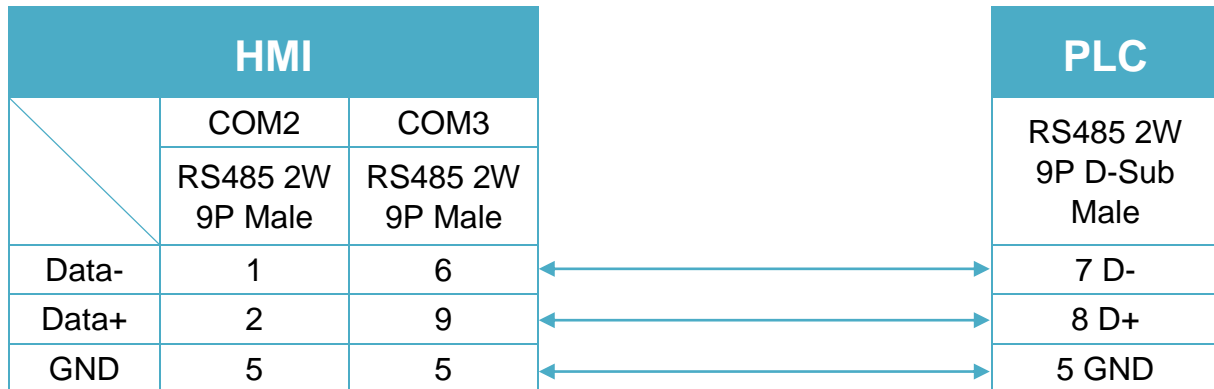
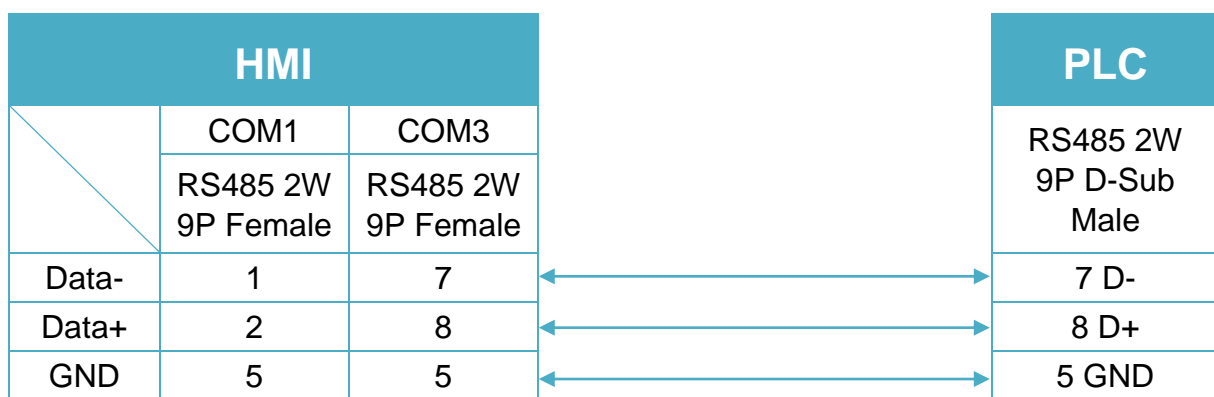
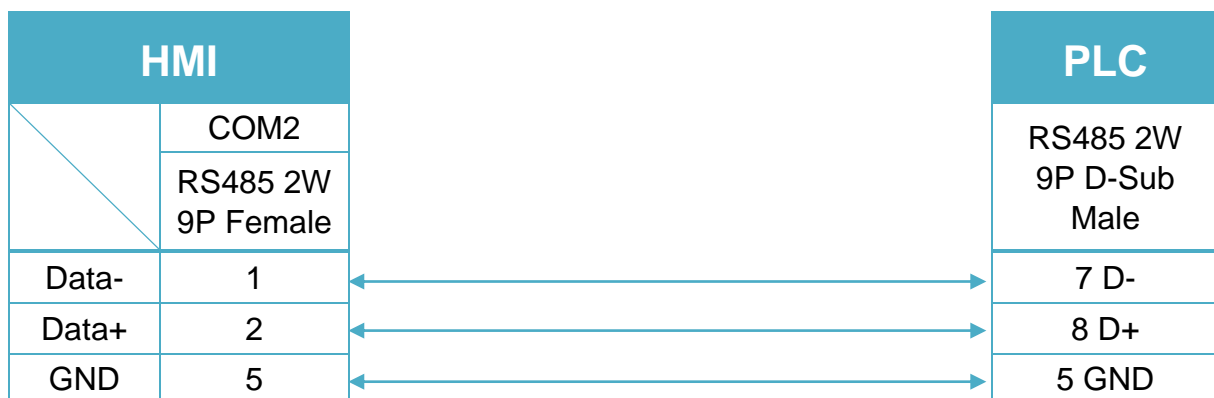


Diagram 4

MT-iE *MT8071iE / MT6071iE / MT8072iE / MT6072iE / MT8073iE /
MT8101iE / MT8102iE / MT8103iE*

MT-XE *MT8090XE / MT8092XE*

MT-iP *MT6103iP*


Diagram 5
MT-iE *MT8050iE*
MT-iP *MT6051iP*

Diagram 6
MT-iP *MT6071iP / MT8071iP*


Nanotec Stepper Motor

Supported Series: Nanotec Stepper Motor

Website: <http://en.nanotec.com/start.html>

HMI Setting:

Parameters	Recommended	Options	Notes
PLC type	Nanotec Stepper Motor		
PLC I/F	RS485 2W		
Baud rate	115200		
Data bits	8		
Parity	None		
Stop bits	1		
PLC sta. no.	1		

Device Address:

Bit/Word	Device type	Format	Range	Memo
W	A1 ~ A14	DD	1 ~ 32	
W	B1 ~ B17	D	1	
W	B18	DD	1 ~ 32	
W	B19 ~ B24	D	1	
W	B25 ~ B26	DD	1 ~ 8	
W	B27 ~ B46	D	1	
W	C1 ~ C6	D	1	
W	D1 ~ D13	D	1	
W	E1 ~ E6	D	1	
W	F1 ~ F41	D	1	
W	G1	D	1	
W	G2	DD	1 ~ 10	
W	G3 ~ G5	DD	1 ~ 7	
W	H1 ~ H10	D	1	
W	J1 ~ J6	D	1	

Wiring Diagram:

Diagram 1

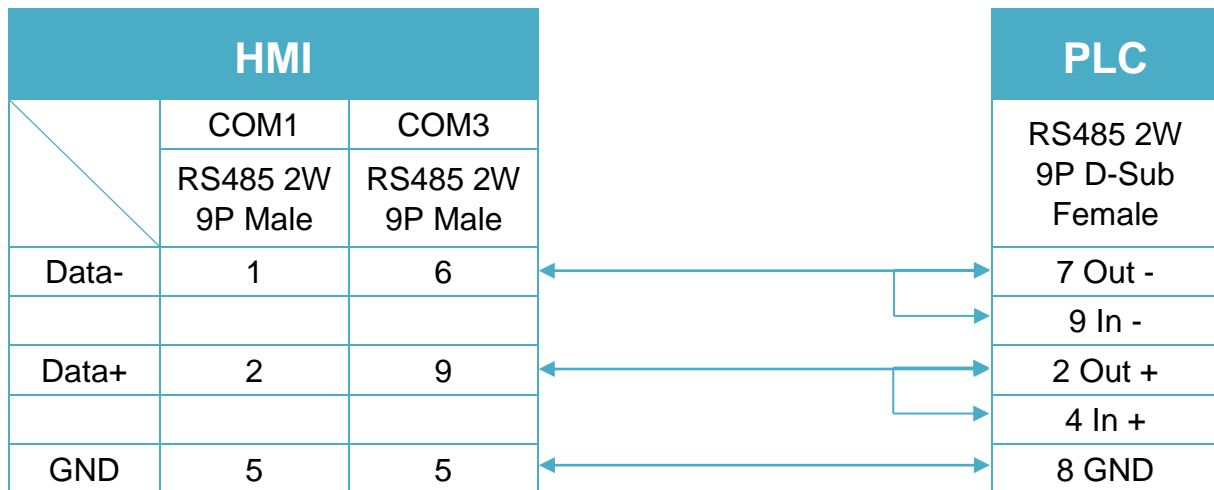
cMT Series
cMT3151
eMT Series
eMT3070 / eMT3105 / eMT3120 / eMT3150


Diagram 2

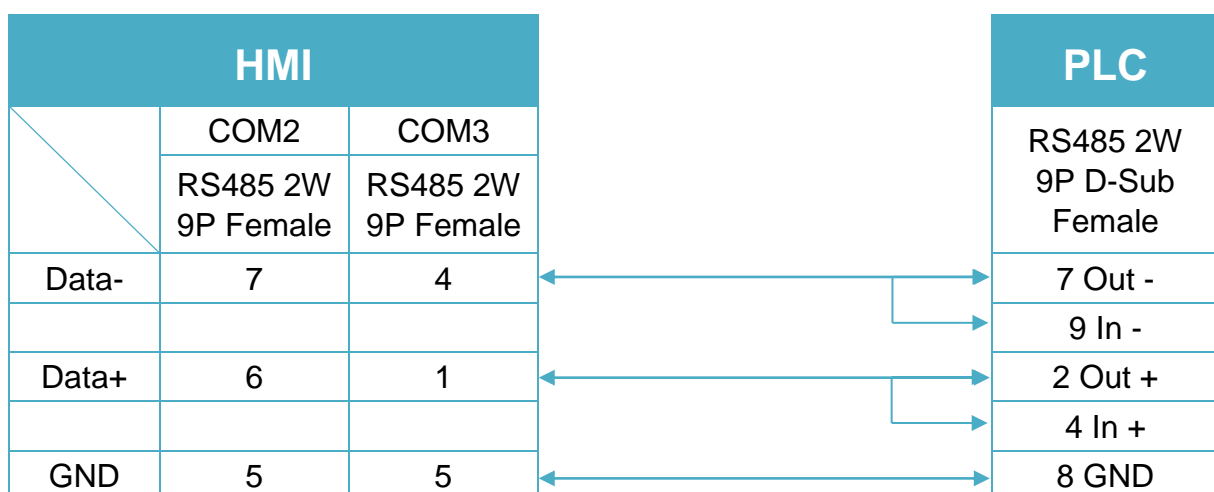
cMT Series
cMT-SVR
mTV
mTV


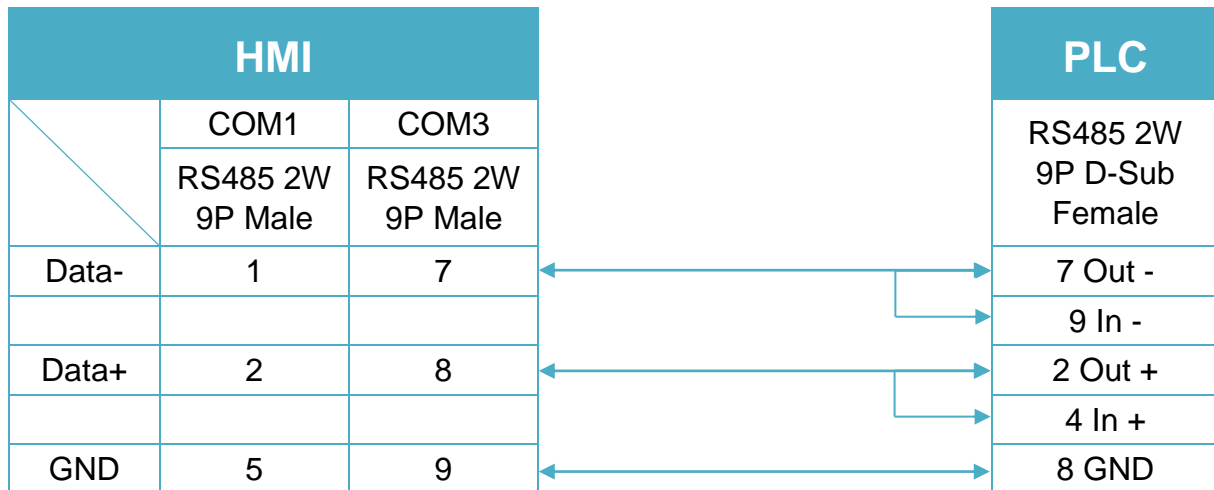
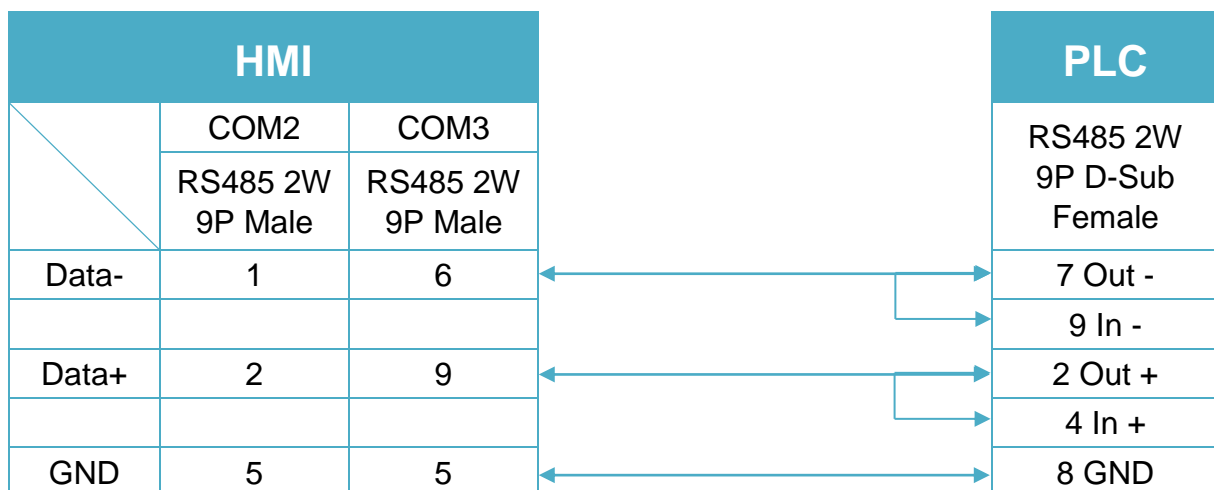
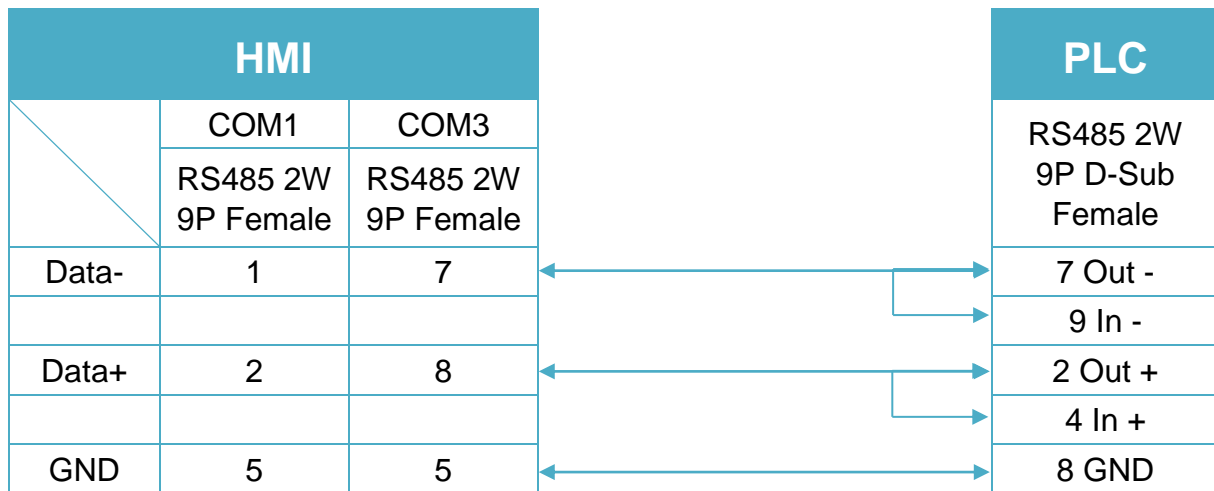
Diagram 3
MT-iE *MT8070iE / MT6070iE / MT8100iE / MT8121iE / MT8150iE*
MT-XE *MT8121XE / MT8150XE*

Diagram 4
MT-iE *MT8071iE / MT6071iE / MT8072iE / MT6072iE / MT8073iE /
MT8101iE / MT8102iE / MT8103iE*
MT-XE *MT8090XE / MT8092XE*
MT-iP *MT6103iP*


Diagram 5
MT-iE *MT8050iE*
MT-iP *MT6051iP*

Diagram 6
MT-iP *MT6071iP / MT8071iP*


NMEA 0183

Supported Series: NMEA 0183 Interface Standard.

HMI Setting:

Parameters	Recommended	Options	Notes
PLC type	NMEA 0183		
PLC I/F	RS232		
Baud rate	4800	4800 ~ 115200	
Data bits	8	7,8	
Parity	None	None,Even,Odd	
Stop bits	1	1,2	

NMEA Sentences:

Support sentences				
AAM	ACK	ADS	AKD	ALA
ALM	ALR	APB	BEC	BOD
BWC	BWR	BWW	COP	CUR
DBT	DCR	DDC	DOR	DPT
DSC	DTM	ETL	EVE	FIR
FSI	GBS	GGA	GLC	GLL
GMP	GNS	GRS	GSA	GST
GSV	HDG	HMR	HMS	HSC
HSS	HTC	HTD	LCD	MLA
MSK	MSS	MTW	MWD	MWV
NAK	NRM	OSD	PRC	RMA
RMB	RMC	ROR	ROT	RPM
RSA	RSD	RST	SFI	SID
STN	THS	TLL	TRD	TTM
TUT	TXT	UID	VBW	VDR
VER	VHW	VLW	VPW	VTG
WAT	WCV	WNC	WPL	XTE
XTR	ZDA	ZDL	ZFO	ZTG

Wiring Diagram:

Diagram 1

cMT Series	<i>cMT3151</i>
eMT Series	<i>eMT3070 / eMT3105 / eMT3120 / eMT3150</i>
MT-iE	<i>MT8073iE / MT8102iE</i>
MT-XE	<i>MT8092XE</i>
MT-iP	<i>MT6103iP</i>



Diagram 2

cMT Series	<i>cMT-SVR</i>
mTV	<i>mTV</i>
MT-iE	<i>MT8070iE / MT6070iE / MT8100iE / MT8121iE / MT8150iE / MT8071iE / MT6071iE / MT8072iE / MT6072iE / MT8073iE / MT8101iE / MT8102iE / MT8103iE</i>
MT-XE	<i>MT8121XE / MT8150XE / MT8090XE</i>

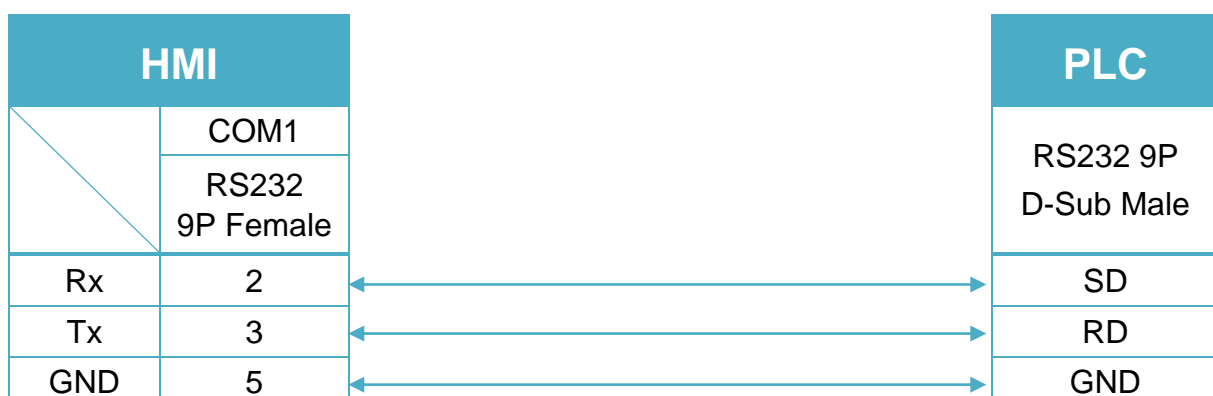
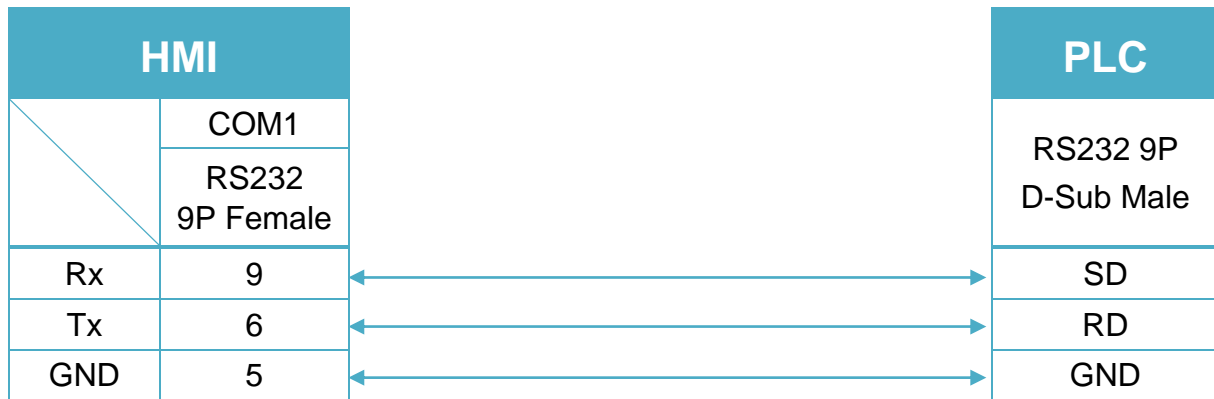


Diagram 3

MT-iE
MT8050iE
MT-iP
MT6051iP / MT6071iP / MT8071iP


ODVA EtherNet/IP Explicit Messaging

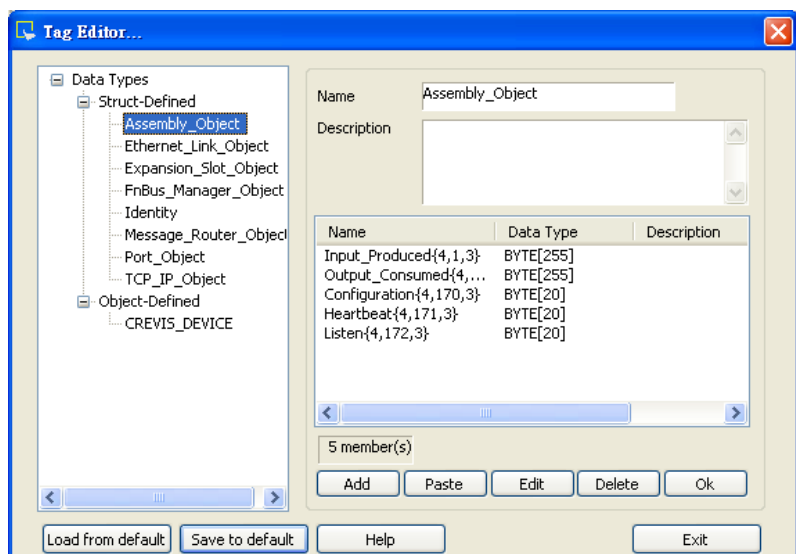
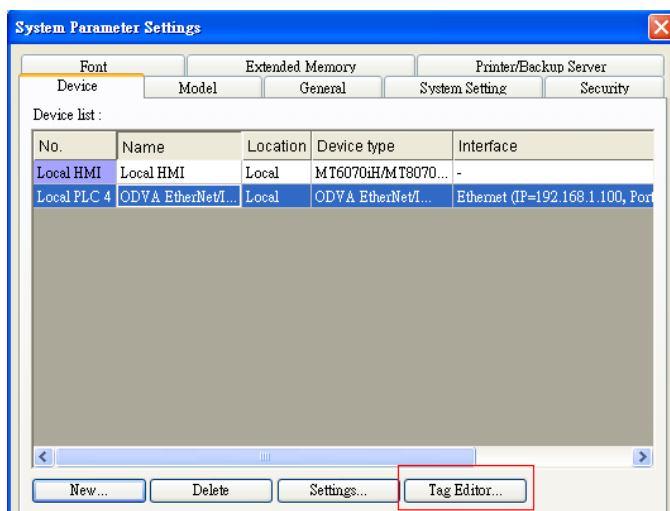
Supported Series: Crevis EtherNet/IP NA-9188

Website: <http://www.crevis.co.kr/>

HMI Setting:

Parameters	Recommended	Options	Notes
PLC type	ODVA EtherNet/IP Explicit Messaging		
PLC I/F	Ethernet		
Port no.	44818		
PLC sta. no.	0		

Please click [Tag Editor] when adding this driver to initiate tag information. To edit address tag, please see the factory manual.



The following is an example of how to add Vendor ID in Tag Editor. See **3.2.3 Identity Object** in factory manual for the detail of this ID.

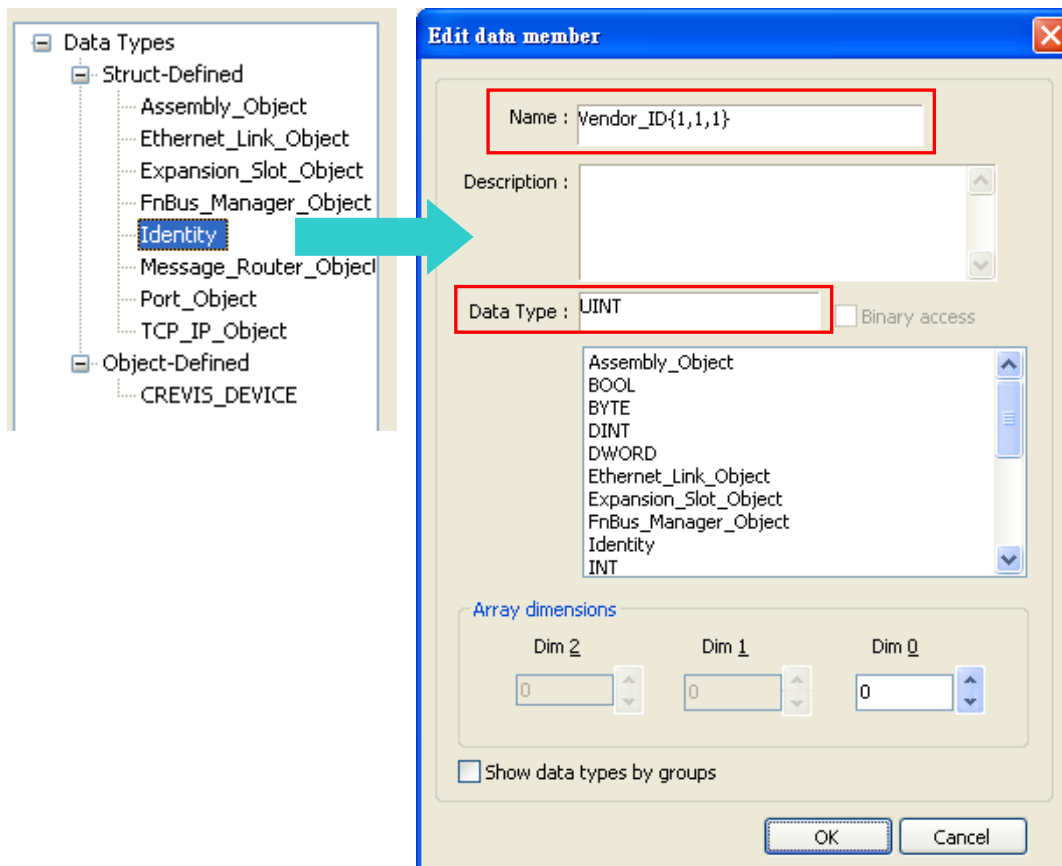
3.2. Identity Object

Class Code: 01_{HEX}

3.2.3. Instance Attributes

Instance ID	Attribute ID	Access Rule	Name	Data Type	Value
1	1	Get	Vendor ID	UINT	741 _{DEC} (Crevis Co. Ltd)
	2	Get	Device Type	UINT	0C _{HEX} (Communications Adapter)
	3	Get	Product Code	UINT	512 _{DEC} (NA-9188)
	4	Get	Revision	Structure of:	
			- Major	USINT	1 ~ 9
			- Minor	USINT	1 ~ 255

Under Struct-Defined select Identity to add Vendor_ID. {1,1,1} represents {**Class code** , **Instance ID** , **Attribute ID**}. Enter “UINT” in Data Type field according to the factory manual. When finished, this data member can be found in Identity Object.



Support Device Type:

Data type	EasyBuilder data format	Memo
Bool	bit	
Byte	16-bit BCD, Hex, Binary, Unsigned	8-bit
SInt	16-bit BCD, Hex, Binary, Signed	8-bit
USInt	16-bit BCD, Hex, Binary, Unsigned	8-bit
Word	16-bit BCD, Hex, Binary, Unsigned	16-bit
Int	16-bit BCD, Hex, Binary, Signed	16-bit
UInt	16-bit BCD, Hex, Binary, Unsigned	16-bit
DWord	32-bit BCD, Hex, Binary, Unsigned	32-bit
DInt	32-bit BCD, Hex, Binary, Signed	32-bit
Real	32-bit Float	32-bit
UDInt	32-bit BCD, Hex, Binary, Unsigned	32-bit
Array	Word array for ASCII input and display	Length=word

Wiring Diagram:

Ethernet cable:



OMRON C/CQM1 Series

Supported Series: OMRON C, CPM, CPL, CQM Series (Host Link Protocol)

Website: <http://www.omron.com/>

HMI Setting:

Parameters	Recommended	Options	Notes
PLC type	OMRON C/CQM1 Series		
PLC I/F	RS232	RS232, RS422, RS485	
Baud rate	9600	9600, 19200	
Data bits	7	7 or 8	
Parity	Even	Even, Odd, None	
Stop bits	2	1 or 2	
PLC sta. no.	0	0-31	Host Link Station No.

Online simulator	YES	Broadcast command	YES
Extend address mode	YES		

*Support communications between HMI and PLC in pass-through mode

*Set LW-9903 to 2 to enhance the speed of download/upload PLC program in pass-through mode

PLC Setting:

Communication mode	Host Link Protocol / PLC must be set to monitor mode
--------------------	--

Device Address:

Bit/Word	Device type	Format	Range	Memo
B	IR	DDDDddd	0 ~ 409515	I/O and Internal Relay
B	HR	DDDDddd	0 ~ 409515	Hold Relay
B	LR	DDDDddd	0 ~ 409515	Link Relay
B	IR (Force Set/Reset)	DDDDddd	0 ~ 409515	
B	HR (Force Set/Reset)	DDDDddd	0 ~ 409515	
B	LR (Force Set/Reset)	DDDDddd	0 ~ 409515	
B	AR	DDDDddd	0 ~ 409515	Auxiliary Relay
W	AR_W	DDDD	0 ~ 4095	
W	IR_W	DDDD	0 ~ 4095	

Bit/Word	Device type	Format	Range	Memo
W	HR_W	DDDD	0 ~ 4095	
W	LR_W	DDDD	0 ~ 4095	
W	TC	DDD	0 ~ 255	
W	DM	DDDD	0 ~ 9999	Data Register

Wiring Diagram:

CPU Port (CPM2A,CQM1/1H,C200H/HS/ALPHA series)

Communication Module:

CPM1-CIF01 adapter (for CPM1/CPM1A/CPM2A series, CQM1/CQM1H series)

CPM1H-SCB41 communication module (for CQM1H-CPU51/61)

(Diagram 1 ~ Diagram 3)

Diagram 1

cMT Series	<i>cMT3151</i>
eMT Series	<i>eMT3070 / eMT3105 / eMT3120 / eMT3150</i>
MT-iE	<i>MT8073iE / MT8102iE</i>
MT-XE	<i>MT8092XE</i>
MT-iP	<i>MT6103iP</i>

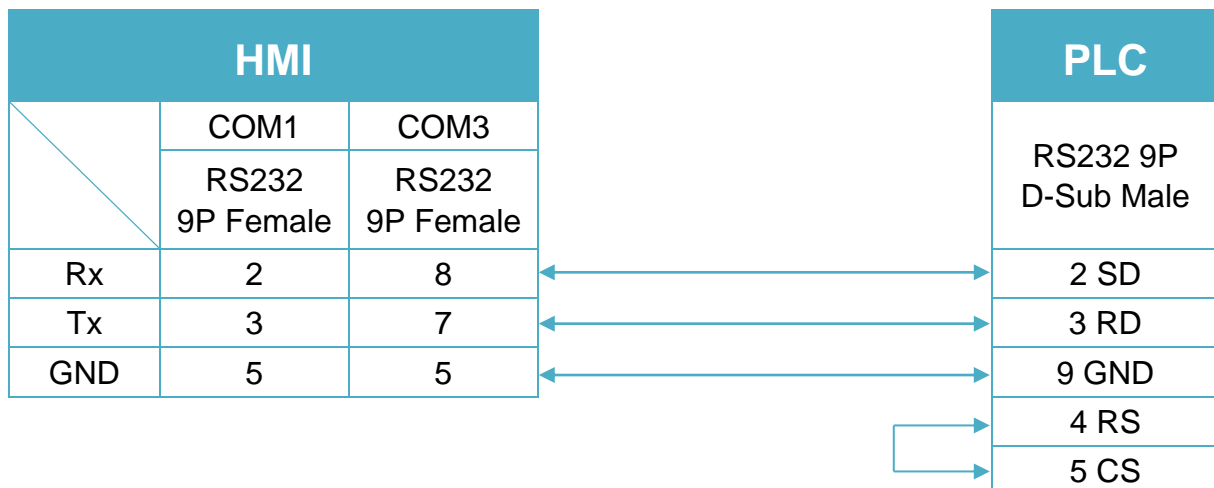


Diagram 2

cMT Series	cMT-SVR
mTV	mTV
MT-iE	MT8070iE / MT6070iE / MT8100iE / MT8121iE / MT8150iE / MT8071iE / MT6071iE / MT8072iE / MT6072iE / MT8073iE / MT8101iE / MT8102iE / MT8103iE
MT-XE	MT8121XE / MT8150XE / MT8090XE

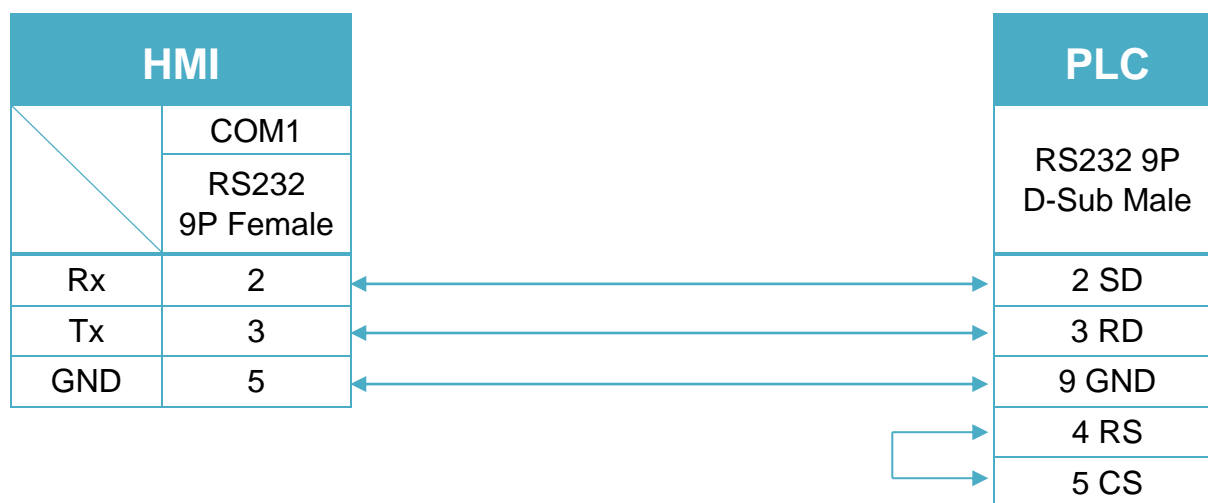
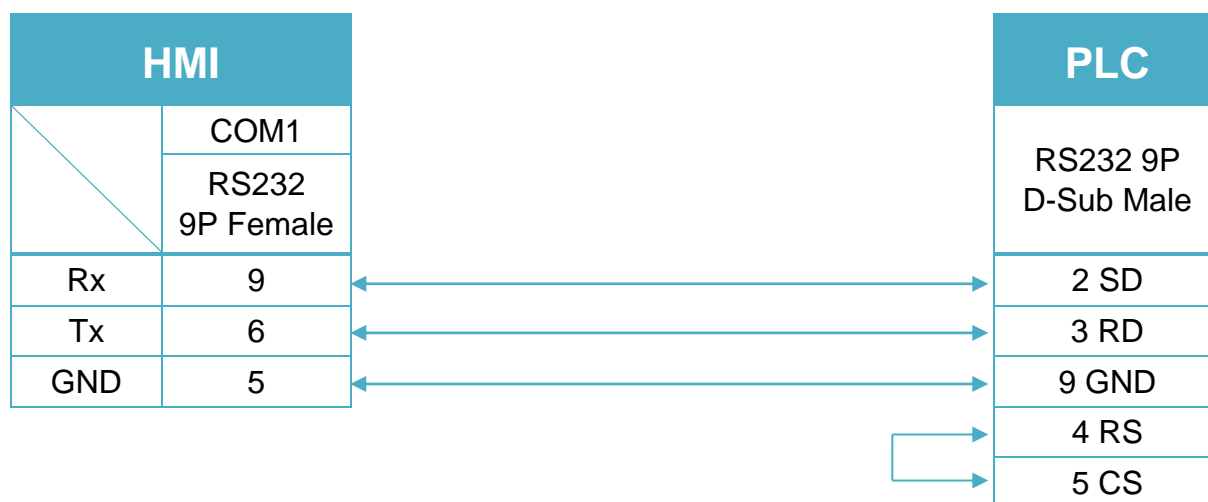


Diagram 3

MT-iE	MT8050iE
MT-iP	MT6051iP / MT6071iP / MT8071iP



C200h-LK201,3G2A6-LK201 communication module
 C200HW-COM02/03/04/05/06 communication module
 (Diagram 4 ~ Diagram 6)

Diagram 4

cMT Series	<i>cMT3151</i>
eMT Series	<i>eMT3070 / eMT3105 / eMT3120 / eMT3150</i>
MT-iE	<i>MT8073iE / MT8102iE</i>
MT-XE	<i>MT8092XE</i>
MT-iP	<i>MT6103iP</i>

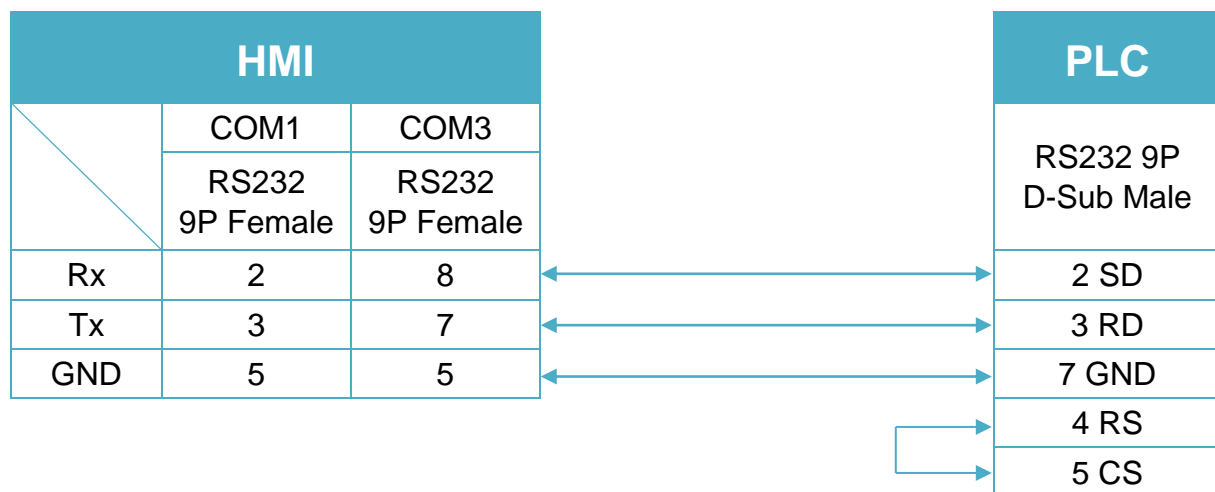


Diagram 5

cMT Series	cMT-SVR
mTV	mTV
MT-iE	MT8070iE / MT6070iE / MT8100iE / MT8121iE / MT8150iE / MT8071iE / MT6071iE / MT8072iE / MT6072iE / MT8073iE / MT8101iE / MT8102iE / MT8103iE
MT-XE	MT8121XE / MT8150XE / MT8090XE

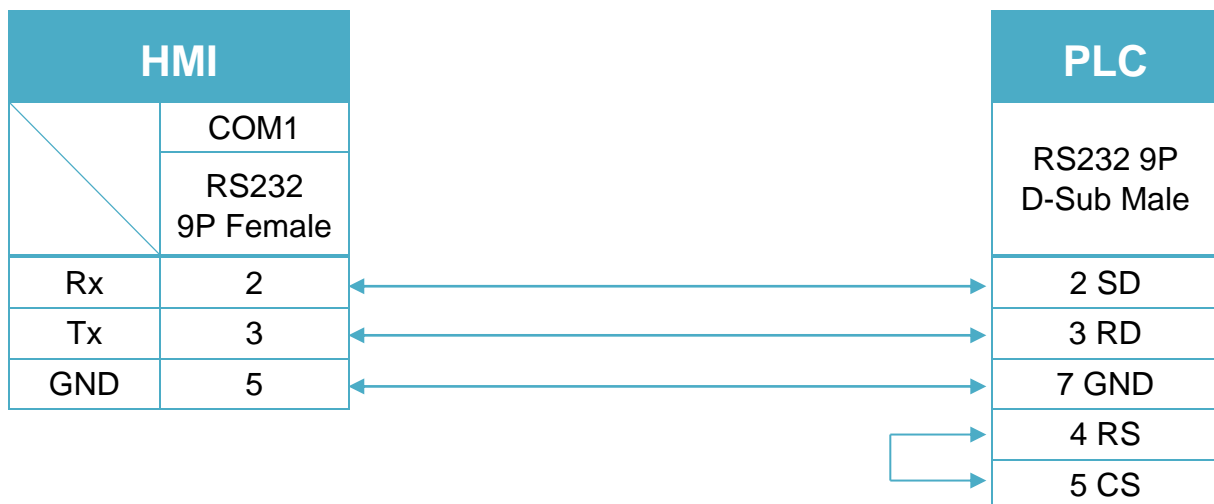
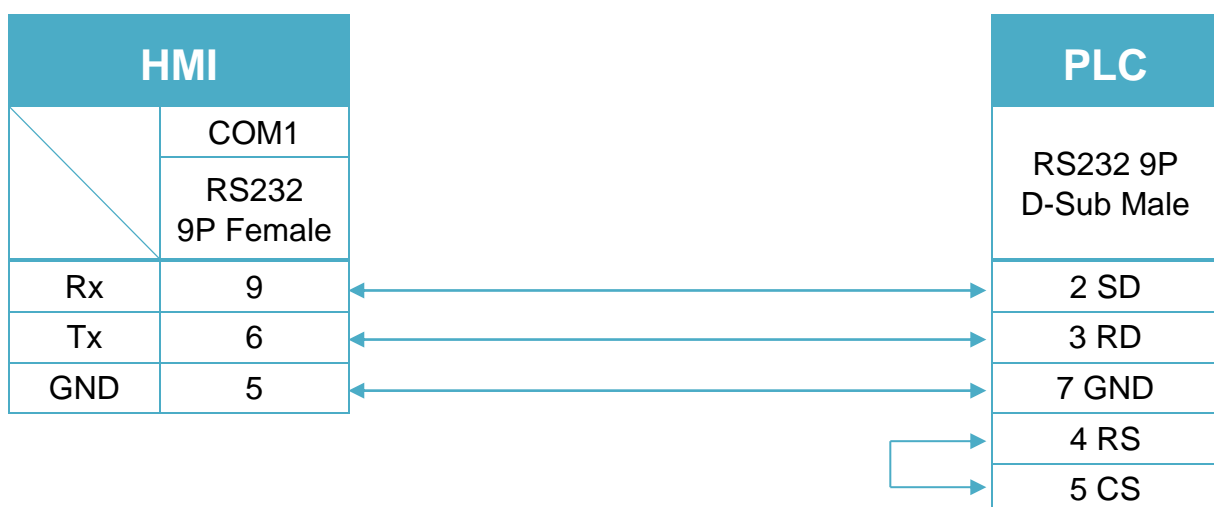


Diagram 6

MT-iE	MT8050iE
MT-iP	MT6051iP / MT6071iP / MT8071iP



OMRON CJ/CS/CP

Supported Series: OMRON CP1E, CP1L, CP1H, CJ1M, CJ2M, CJ1H, CJM1G, CS1H and CS1G. (Host Link Protocol FINS command), this driver supports Extend Addressing Mode.

Website: <http://www.omron.com/>

HMI Setting:

Parameters	Recommended	Options	Notes
PLC type	OMRON CJ/CS/CP		
PLC I/F	RS232	RS232, RS422, RS485	
Baud rate	9600	9600~115200	
Data bits	7	7 or 8	
Parity	Even	Even, Odd, None	
Stop bits	2	1 or 2	
PLC sta. no.	0	0-31	Host Link Station No.

Online simulator	YES	Extend address	YES
Broadcast	NO		

*Support communications between HMI and PLC in pass-through mode

*Set LW-9903 to 2 to enhance the speed of download/upload PLC program in pass-through mode

PLC Setting:

Communication	Host Link Protocol
----------------------	--------------------

Device Address:

Bit/Word	Device type	Format	Range	Memo
B	CIO_Bit	DDDDDDdd	0 ~ 3276715	Channel I/O (CIO)
B	W_Bit	DDDDDDdd	0 ~ 3276715	Work Area (WR)
B	H_Bit	DDDDDDdd	0 ~ 3276715	Holding Area (HR)
B	D_Bit	DDDDDDdd	0 ~ 3276715	Data Memory (DM)
B	A_Bit	DDDDDDdd	0 ~ 3276715	Auxiliary Relay (AR)
B	T_Bit	DDDDDDdd	0 ~ 3276715	Timer (TIM)
B	C_Bit	DDDDDDdd	0 ~ 3276715	Counter (CNT)
B	C_flag	DDDD	0 ~ 4095	

Bit/Word	Device type	Format	Range	Memo
B	T_flag	DDDD	0 ~ 4095	
B	LR_Bit	DDDdd	0 ~ 19915	
B	EM0_Bit ~ EM18_Bit	DDDDDDdd	0 ~3276715	Extend Memory
W	T	DDDDD	0 ~ 32767	Timer (TIM)
W	H	DDDDD	0 ~ 32767	Holding Area (HR)
W	D	DDDDD	0 ~ 32767	Data Memory (DM)
W	A	DDDDD	0 ~ 32767	Auxiliary Relay (AR)
W	W	DDDDD	0 ~ 32767	Work Area (WR)
W	C	DDDDD	0 ~ 32767	Counter (CNT)
W	CIO	DDDDD	0 ~ 32767	Channel I/O (CIO)
W	EM0 ~ EM18	DDDDD	0 ~ 32767	Extend Memory
W	LR	DDD	0 ~ 199	

Wiring Diagram:

RS-232 9P D-Sub (Diagram 1 ~ Diagram 3)

Diagram 1

cMT Series	<i>cMT3151</i>
eMT Series	<i>eMT3070 / eMT3105 / eMT3120 / eMT3150</i>
MT-iE	<i>MT8073iE / MT8102iE</i>
MT-XE	<i>MT8092XE</i>
MT-iP	<i>MT6103iP</i>

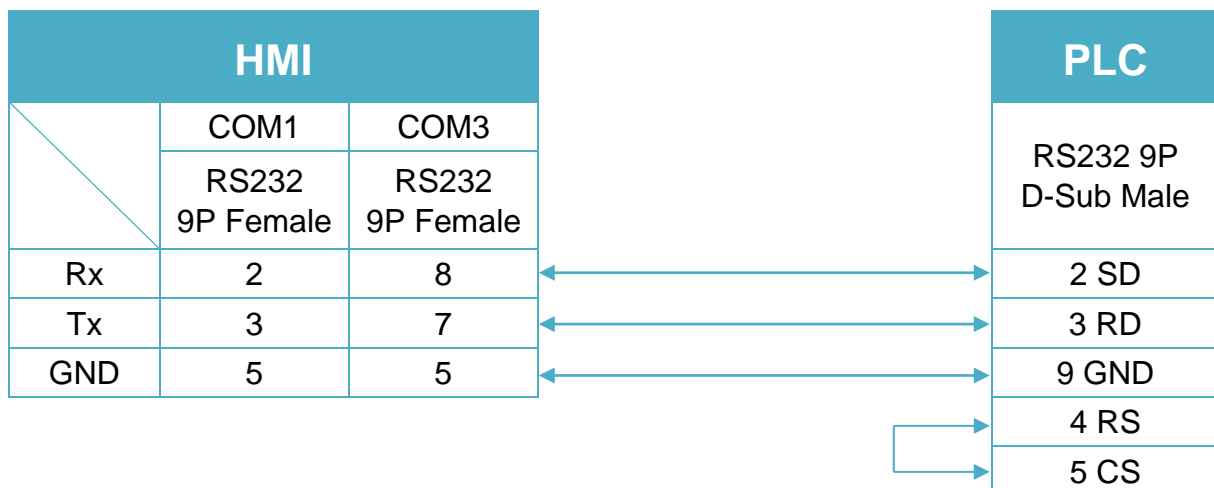


Diagram 2

cMT Series	cMT-SVR
mTV	mTV
MT-iE	MT8070iE / MT6070iE / MT8100iE / MT8121iE / MT8150iE / MT8071iE / MT6071iE / MT8072iE / MT6072iE / MT8073iE / MT8101iE / MT8102iE / MT8103iE
MT-XE	MT8121XE / MT8150XE / MT8090XE

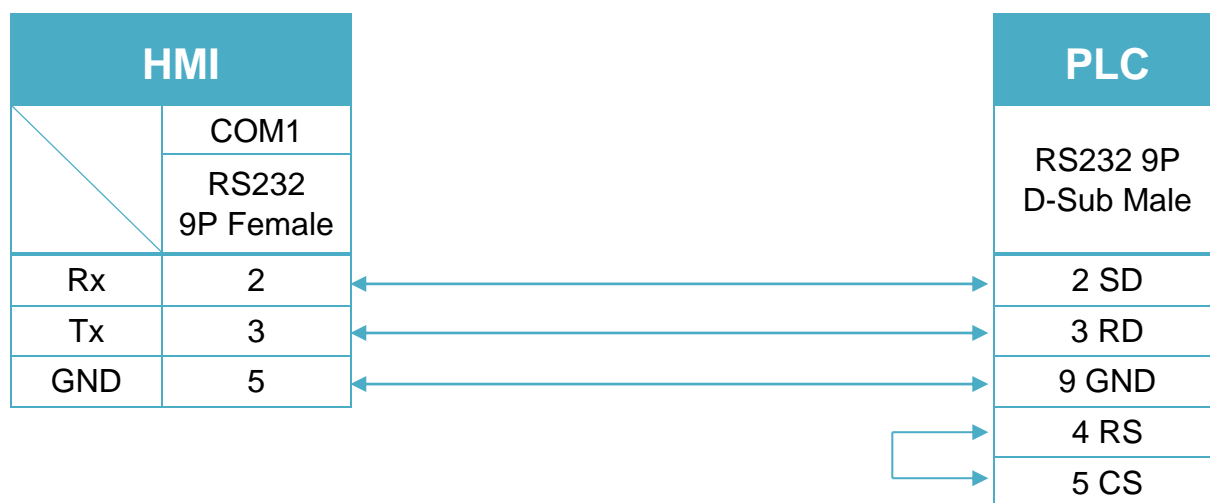
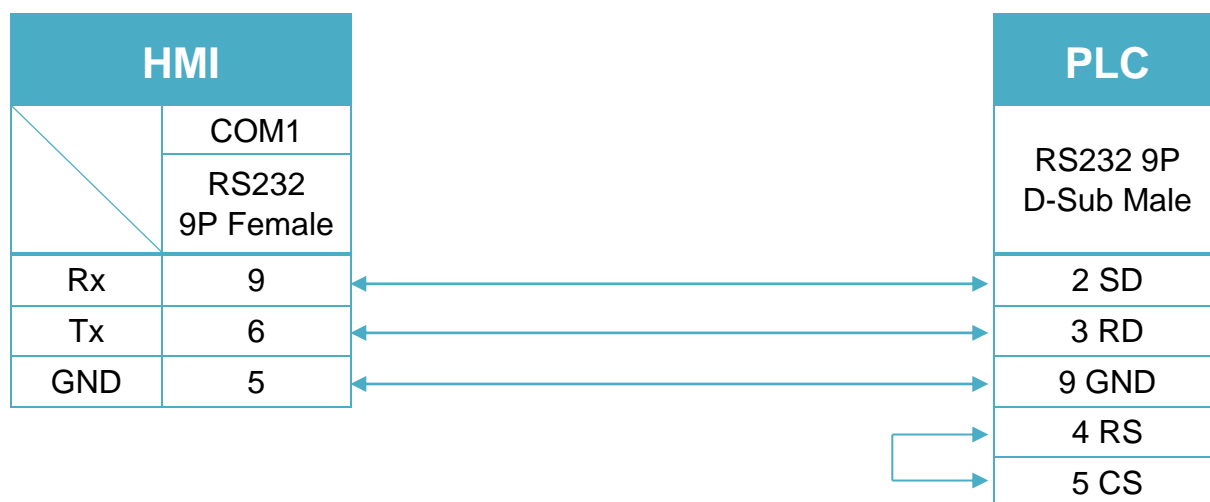


Diagram 3

MT-iE	MT8050iE
MT-iP	MT6051iP / MT6071iP / MT8071iP



RS-485 4W Terminal (Diagram 4 ~ Diagram 7)

CP1H/CP1L CP1W-CIF11 RS485 4W : 9P D-Sub to Terminals:

Diagram 4

cMT Series	<i>cMT3151</i>
eMT Series	<i>eMT3070 / eMT3105 / eMT3120 / eMT3150</i>
MT-iE	<i>MT8070iE / MT6070iE / MT8100iE / MT8121iE / MT8150iE</i>
MT-XE	<i>MT8121XE / MT8150XE</i>

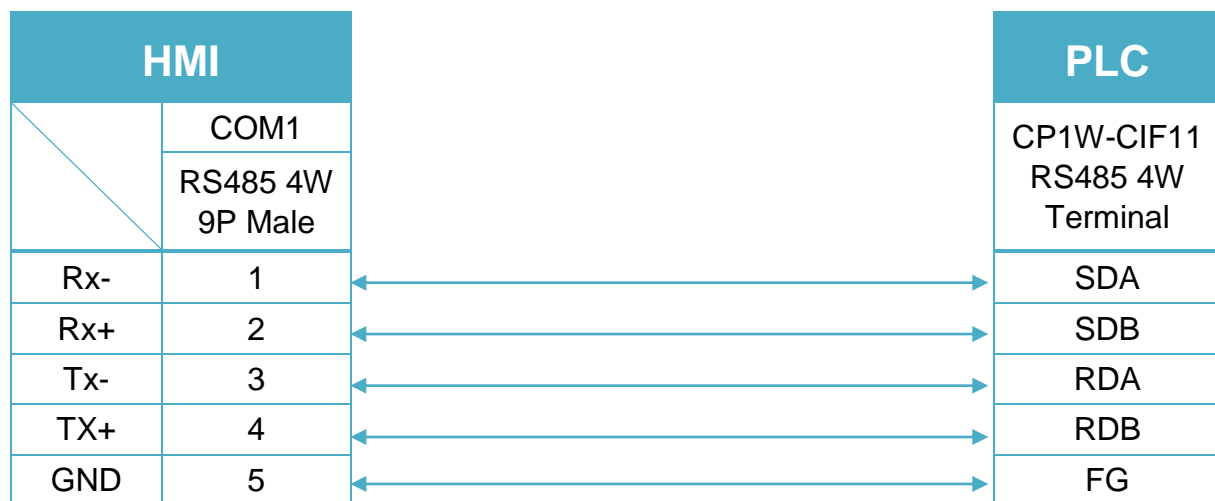


Diagram 5

cMT Series	<i>cMT-SVR</i>
mTV	<i>mTV</i>

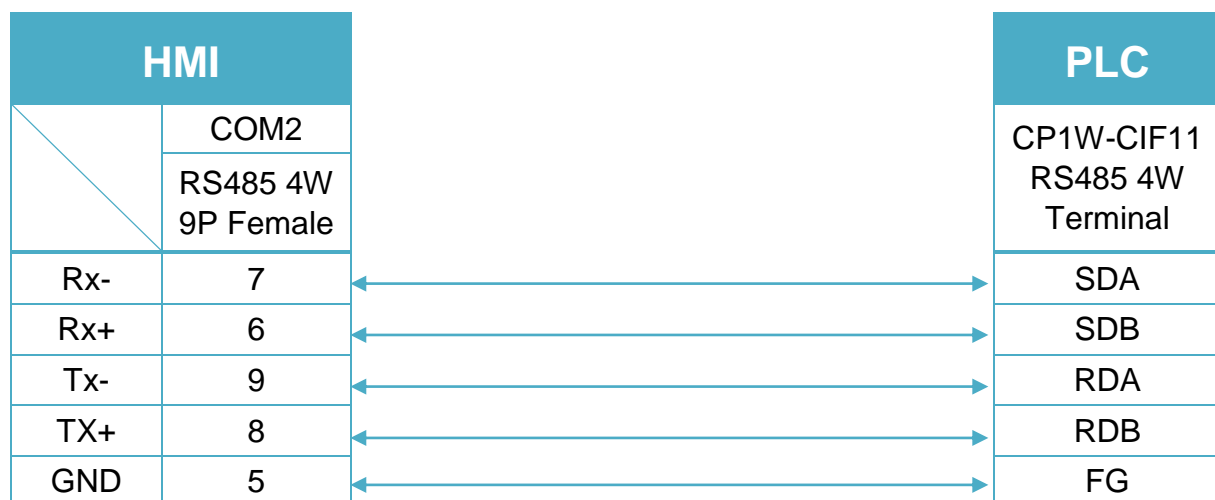


Diagram 6

MT-iE	<i>MT8071iE / MT6071iE / MT8072iE / MT6072iE / MT8073iE / MT8101iE / MT8102iE / MT8103iE</i>
MT-XE	<i>MT8090XE / MT8092XE</i>
MT-iP	<i>MT6071iP / MT8071iP / MT6103iP</i>

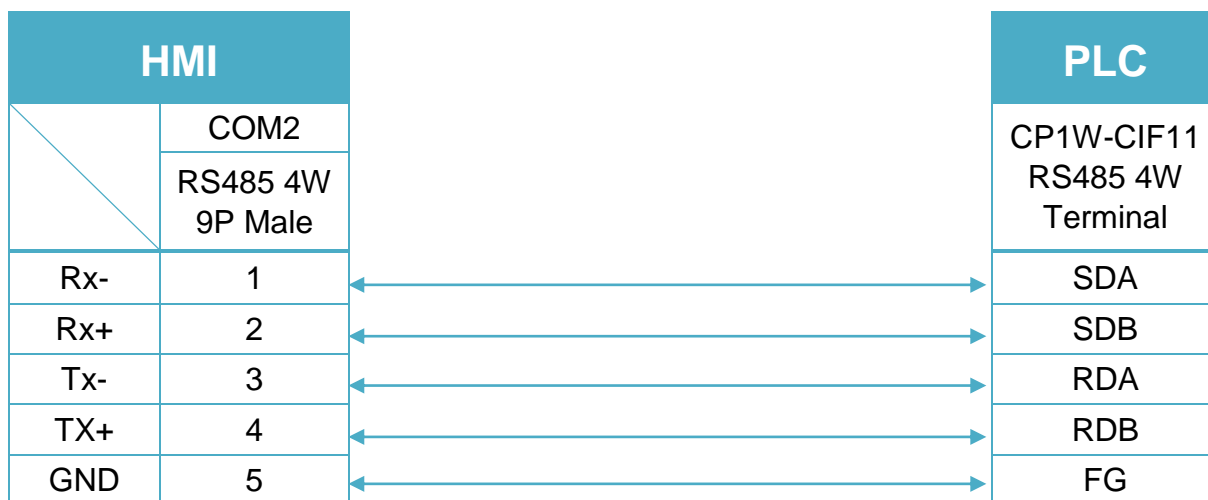


Diagram 7

MT-iE	<i>MT8050iE</i>
MT-iP	<i>MT6051iP</i>



CP1W-CIF11: SW1 ON, others OFF.

OMRON CJ/CS/CP (Ethernet - FINS/TCP)

Supported Series: OMRON CJ Series, CS Series, CP Series +Ethernet Module. (Ethernet FINS)

Website: <http://www.omron.com/>

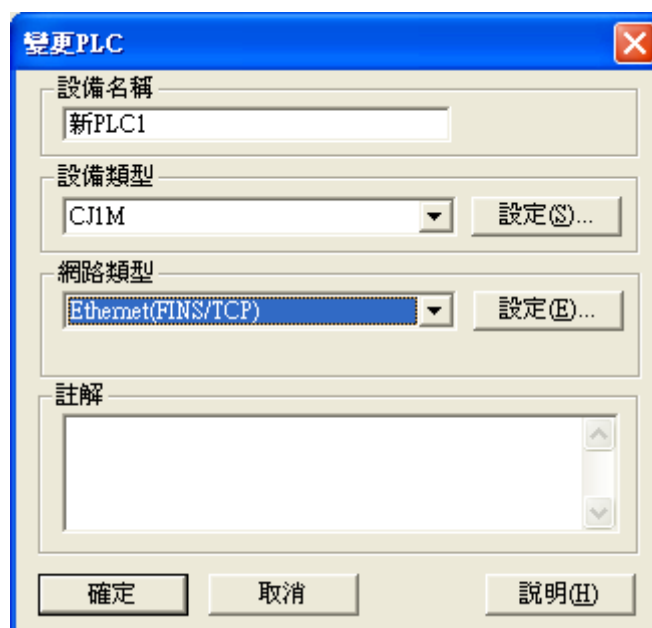
*On initialization, switch from RUN MODE to MONITOR MODE.

HMI Setting:

Parameters	Recommended	Options	Notes
PLC type	OMRON CJ/CS/CP (Ethernet - FINS/TCP)		
PLC I/F	Ethernet		
Port no.	9600		
PLC sta. no.	0		

PLC Setting:

Communication mode	Ethernet (FINS/TCP) protocol
---------------------------	------------------------------



Device Address:

Bit/Word	Device type	Format	Range	Memo
B	CIO_Bit	DDDDDDdd	0 ~ 3276715	Channel I/O (CIO)
B	W_Bit	DDDDDDdd	0 ~ 3276715	Work Area (WR)
B	H_Bit	DDDDDDdd	0 ~ 3276715	Holding Area (HR)
B	A_Bit	DDDDDDdd	0 ~ 3276715	Auxiliary Relay (AR) (Read
B	D_Bit	DDDDDDdd	0 ~ 3276715	Data Memory (DM)
B	T_Bit	DDDDDDdd	0 ~ 3276715	Timer (TIM)
B	C_Bit	DDDDDDdd	0 ~ 3276715	Counter (CNT)
B	C_Flag	DDDD	0 ~ 4095	
B	T_Flag	DDDD	0 ~ 4095	
B	EM0_Bit ~ EM18_Bit	DDDDDDdd	0 ~ 3276715	Extend Memory
W	CIO	DDDDDD	0 ~ 32767	Channel I/O (CIO)
W	W	DDDDDD	0 ~ 32767	Work Area (WR)
W	H	DDDDDD	0 ~ 32767	Holding Area (HR)
W	A	DDDDDD	0 ~ 32767	Auxiliary Relay (AR) (Read
W	C	DDDDDD	0 ~ 32767	Counter (CNT)
W	T	DDDDDD	0 ~ 32767	Timer (TIM)
W	D	DDDDDD	0 ~ 32767	Data Memory (DM)
W	EM0 ~ EM18	DDDDDD	0 ~ 32767	Extend Memory

Wiring Diagram:

Ethernet cable:



OMRON CP Series (USB)

Supported Series: OMRON CP1E CPU Module USB Port.

Website: <http://www.omron.com/>

HMI Setting:

Parameters	Recommended	Options	Notes
PLC type	OMRON CP Series (USB)		
PLC I/F	USB		USB Host

Online simulator	No
------------------	----

Device Address:

Bit/Word	Device type	Format	Range	Memo
B	CIO_Bit	DDDdd	0 ~ 28915	Channel I/O (CIO)
B	A_Bit	DDDdd	0 ~ 75315	Auxiliary Relay (AR)
B	T_Bit	DDDdd	0 ~ 25515	Timer (TIM)
B	C_Bit	DDDdd	0 ~ 25515	Counter (CNT)
B	D_Bit	DDDDdd	0 ~ 204715	Data Memory (DM)
B	H_Bit	DDdd	0 ~ 4915	Holding Area (HR)
B	W_Bit	DDdd	0 ~ 9915	Work Area (WR)
W	CIO	DDD	0 ~ 289	Channel I/O (CIO)
W	A	DDD	0 ~ 753	Auxiliary Relay (AR)
W	T	DDD	0 ~ 255	Timer (TIM)
W	C	DDD	0 ~ 255	Counter (CNT)
W	D	DDDD	0 ~ 2047	Data Memory (DM)
W	H	DD	0 ~ 49	Holding Area (HR)
W	W	DD	0 ~ 99	Work Area (WR)

OMRON E5CN/E5EZ/E5ZN

Supported Series: OMRON E5CN series temperature controller with communication options. E5EN/CN/GN/EZ/ZN series.

Website: <http://oeiweb.omron.com>

HMI Setting:

Parameters	Recommended	Options	Notes
PLC type	OMRON E5CN		
PLC I/F	RS485 2W		
Baud rate	9600	9600/19200/38400/ 57600/115200	
Data bits	7	7,8	
Parity	Even	Even, Odd, None	
Stop bits	2	1,2	
PLC sta. no.	0	0-99	

Online simulator	YES	Broadcast command	YES
Extend address mode	YES		

*Support communications between HMI and PLC in pass-through mode

*Set LW-9903 to 2 to enhance the speed of download/upload PLC program in pass-through mode

Device Address:

Bit/Word	Device	Format	Range	Memo
B	Status_CH1	DD	0 ~ 31	Page40
B	Status_CH2	DD	0 ~ 31	
DW	C0	HHHH	0 ~ 270f	Read only (Hex) Page34
DW	C1	HHHH	0 ~ 270f	Read/Write (Hex) Page35
DW	C2	HHHH	0 ~ 270f	Read/Write (Hex) Page35
DW	C3	HHHH	0 ~ 270f	Read/Write (Hex) Page36
W	Code00_00	H	0	Communications writing OFF (disabled)
W	Code00_01	H	0	Communications writing ON(enabled)
W	Code01_00	H	0	Run
W	Code01_01	H	0	Stop
W	Code02_00	H	0	Multi-SP Set point 0

Bit/Word	Device	Format	Range	Memo
W	Code02_01	H	0	Multi-SP Set point 1
W	Code02_02	H	0	Multi-SP Set point 2
W	Code02_03	H	0	Multi-SP Set point 3
W	Code03_00	H	0	AT cancel
W	Code03_01	H	0	AT execute
W	Code04_00	H	0	Write mode (Backup)
W	Code04_01	H	0	Write mode (Ram)
W	Code05_00	H	0	Save RAM data
W	Code06_00	H	0	Software reset
W	Code07_00	H	0	Move to setup area 1
W	Code08_00	H	0	Move to protect level
W	Code01_10	H	0	
W	Code01_11	H	0	
W	Code01_F0	H	0	
W	Code01_F1	H	0	
W	Code02_10	H	0	
W	Code02_11	H	0	
W	Code02_F0	H	0	
W	Code02_F1	H	0	
W	Code03_10	H	0	
W	Code03_11	H	0	
W	Code03_F0	H	0	
W	Code03_F1	H	0	
W	Code09_00	H	0	
W	Code09_01	H	0	
W	Code09_10	H	0	
W	Code09_11	H	0	
W	Code09_F0	H	0	
W	Code09_F1	H	0	
W	Code0A_00	H	0	
W	Code0B_00	H	0	
W	Code0C_00	H	0	
W	Code0C_01	H	0	
W	Code0C_02	H	0	
W	Code0C_0F	H	0	
W	Code0C_10	H	0	
W	Code0C_11	H	0	

Bit/Word	Device	Format	Range	Memo
W	Code0C_12	H	0	
W	Code0C_1F	H	0	
W	Code0C_F0	H	0	
W	Code0C_F1	H	0	
W	Code0C_F2	H	0	
W	Code0C_FF	H	0	

Wiring Diagram:

Diagram 1

cMT Series

cMT3151

eMT Series

eMT3070/ eMT3105 / eMT3120 / eMT3150

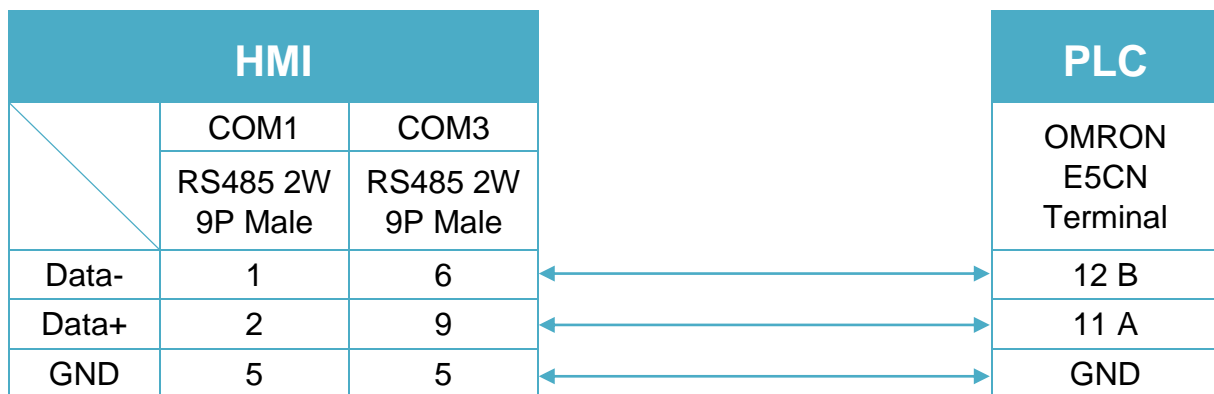


Diagram 2

cMT Series

cMT-SVR

mTV

mTV

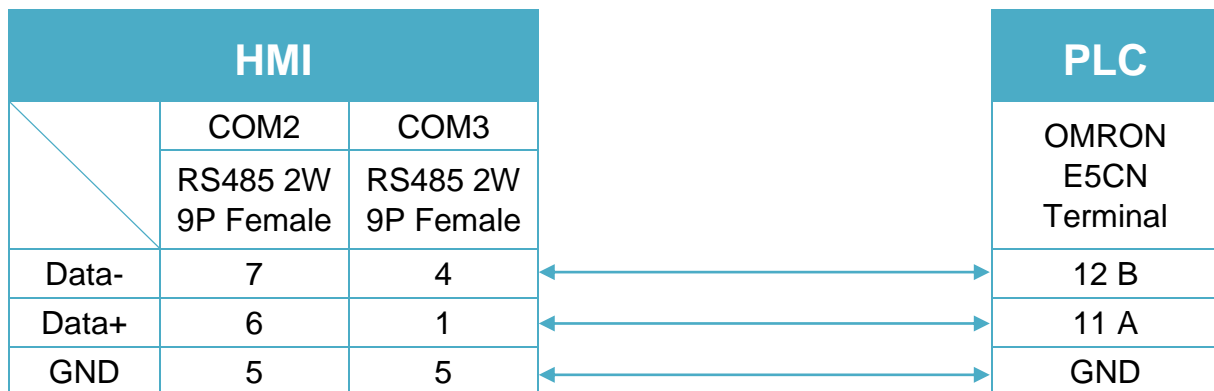


Diagram 3

MT-iE *MT8070iE / MT6070iE / MT8100iE / MT8121iE / MT8150iE*

MT-XE *MT8121XE / MT8150XE*

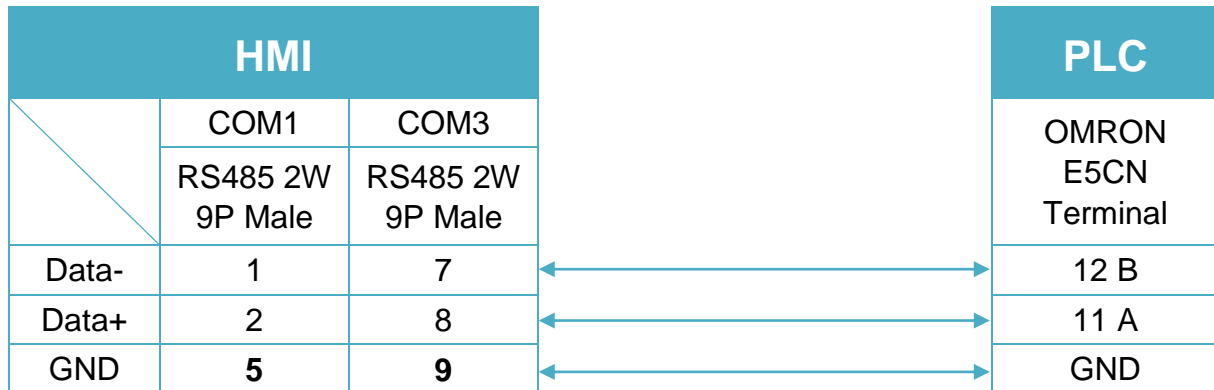


Diagram 4

MT-iE *MT8071iE / MT6071iE / MT8072iE / MT6072iE / MT8073iE /
MT8101iE / MT8102iE / MT8103iE*

MT-XE *MT8090XE / MT8092XE*

MT-iP *MT6103iP*

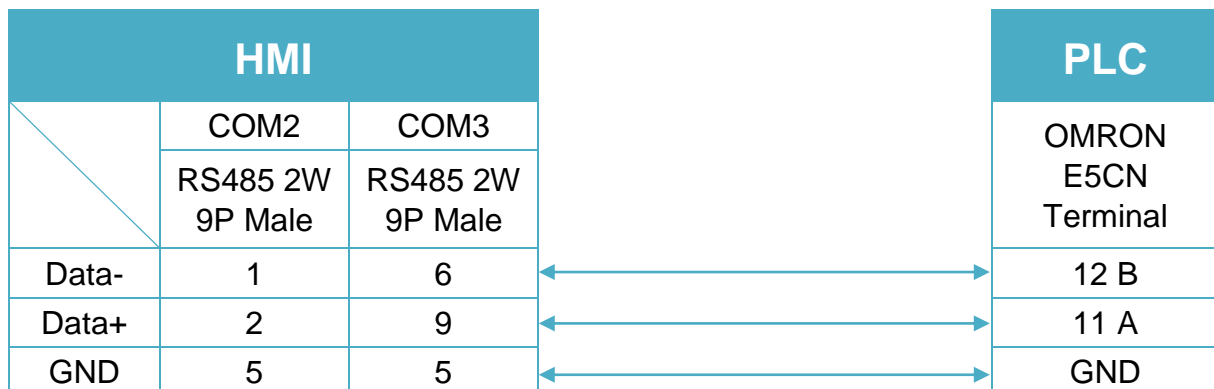


Diagram 5

MT-iE *MT8050iE*

MT-iP *MT6051iP*

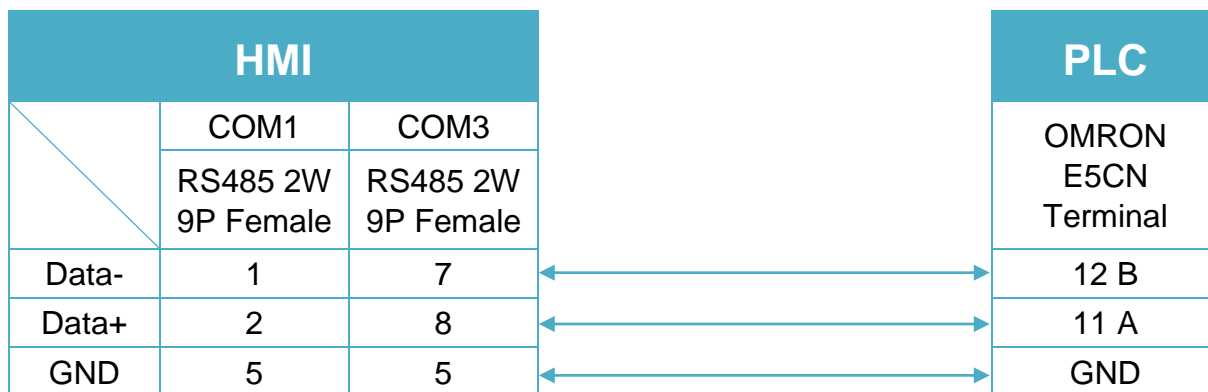


Diagram 6

MT-iP *MT6071iP / MT8071iP*



Note:

For communication with OMRON E5EZ, please set communication settings to 9600, E, 7, 2, station no. 1.

OMRON Ethernet

Supported Series: OMRON CJ Series, CS Series, CP Series +Ethernet Module. (Ethernet FINS)

Website: <http://www.omron.com/>

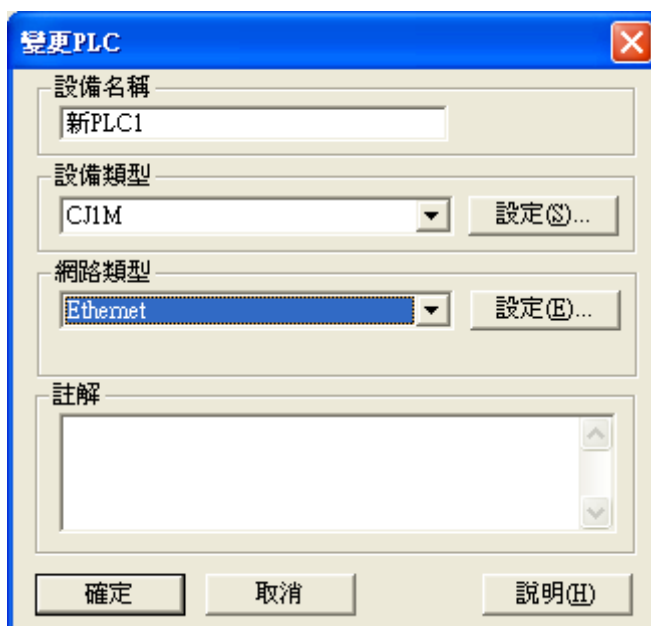
*On initialization, switch from RUN MODE to MONITOR MODE.

HMI Setting:

Parameters	Recommended	Options	Notes
PLC type	OMRON Ethernet		
PLC I/F	Ethernet (UDP)		
Port no.	9600		
PLC sta. no.	0		

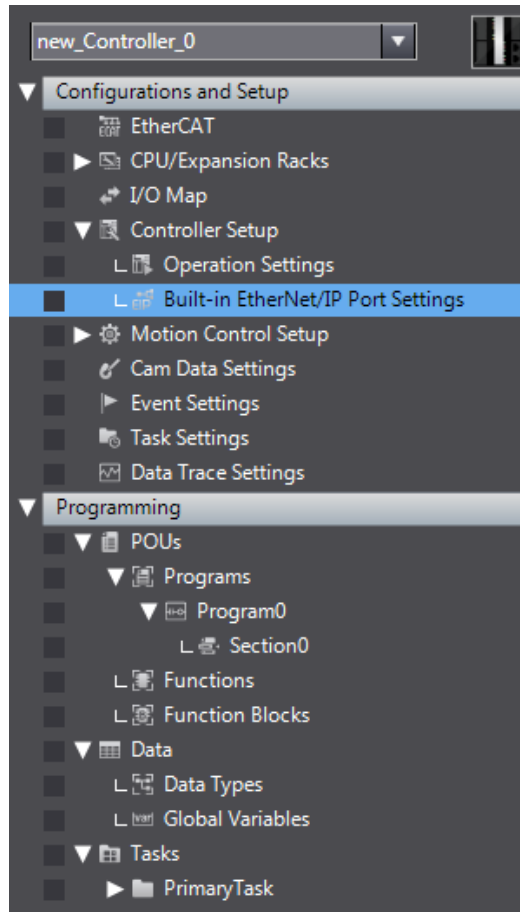
PLC Setting:

Communication mode	Ethernet (UDP) protocol
---------------------------	-------------------------

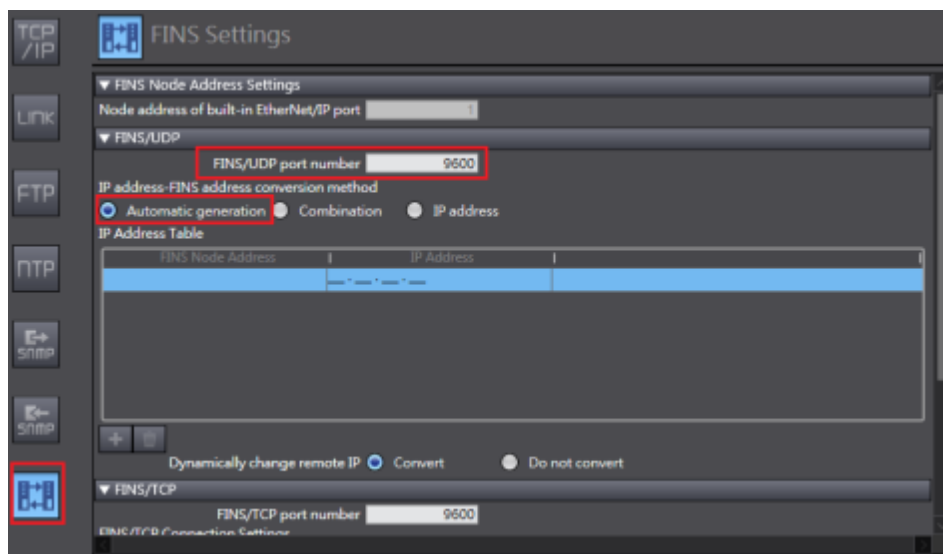


How to connect OMRON NJ and NX Series:

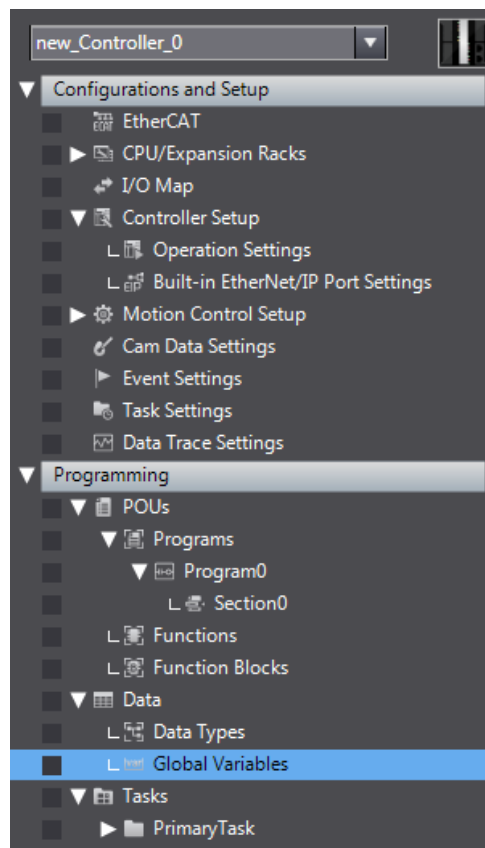
1. In the tree menu on the left hand side, select Controller Setup » Built-in EtherNet/IP Port Settings.



2. Click the button (FINS) marked in the red frame below, and enter 9600 as the FINS/UDP port number. Select Automatic Generation as conversion method.



3. Select Global Variables to set PLC address.



4. Please note that the setting marked in red frame below should be an absolute address mapping to Omron Etherne.

Name	Data Type	Initial Value	AT	Retain	Constant	Network Publish	Comment
TestW0	WORD		%W0	<input type="checkbox"/>	<input type="checkbox"/>	Do not publish	

Device Address:

Bit/Word	Device type	Format	Range	Memo
B	CIO_Bit	DDDDDDdd	0 ~ 3276715	Channel I/O (CIO)
B	W_Bit	DDDDDDdd	0 ~ 3276715	Work Area (WR)
B	H_Bit	DDDDDDdd	0 ~ 3276715	Holding Area (HR)
B	A_Bit	DDDDDDdd	0 ~ 3276715	Auxiliary Relay (AR) (Read only)
B	D_Bit	DDDDDDdd	0 ~ 3276715	Data Memory (DM)
B	T_Bit	DDDDDDdd	0 ~ 3276715	Timer (TIM)
B	C_Bit	DDDDDDdd	0 ~ 3276715	Counter (CNT)
B	C_Flag	DDDD	0 ~ 4095	
B	T_Flag	DDDD	0 ~ 4095	
B	EM0_Bit ~ EMC_Bit	DDDDDDdd	0 ~ 3276715	Extend Memory Bit
B	CIO_Bit_Force	DDDDDDdd	0 ~ 3276715	CIO Bit Force Command
W	CIO	DDDDD	0 ~ 32767	Channel I/O (CIO)
W	W	DDDDD	0 ~ 32767	Work Area (WR)
W	H	DDDDD	0 ~ 32767	Holding Area (HR)
W	A	DDDDD	0 ~ 32767	Auxiliary Relay (AR) (Read only)
W	C	DDDDD	0 ~ 32767	Counter (CNT)
W	T	DDDDD	0 ~ 32767	Timer (TIM)
W	D	DDDDD	0 ~ 32767	Data Memory (DM)
W	EM0 ~ EMC	DDDDD	0 ~ 32767	Extend Memory

Wiring Diagram:

Ethernet cable:



OMRON Ethernet (FINS/TCP)

Supported Series: Non OMRON PLC . (Ethernet FINS)

HMI Setting:

Parameters	Recommended	Options	Notes
PLC type	OMRON Ethernet (FINS/TCP)		
PLC I/F	Ethernet		
Port no.	9600		
PLC sta. no.	0		

PLC Setting:

Communication mode	Ethernet (FINS/TCP) protocol
--------------------	------------------------------

Device Address:

Bit/Word	Device type	Format	Range	Memo
B	CIO_Bit	DDDDdd	0 ~ 3276715	Channel I/O (CIO)
B	W_Bit	DDDDdd	0 ~ 3276715	Work Area (WR)
B	H_Bit	DDDDdd	0 ~ 3276715	Holding Area (HR)
B	A_Bit	DDDDdd	0 ~ 3276715	Auxiliary Relay (AR) (Read only)
B	D_Bit	DDDDdd	0 ~ 3276715	Data Memory (DM)
B	T_Bit	DDDDdd	0 ~ 3276715	Timer (TIM)
B	C_Bit	DDDDdd	0 ~ 3276715	Counter (CNT)
B	C_Flag	DDDD	0 ~ 4095	
B	T_Flag	DDDD	0 ~ 4095	
W	CIO	DDDD	0 ~ 32767	Channel I/O (CIO)
W	W	DDDD	0 ~ 32767	Work Area (WR)
W	H	DDDD	0 ~ 32767	Holding Area (HR)
W	A	DDDD	0 ~ 32767	Auxiliary Relay (AR) (Read only)
W	C	DDDD	0 ~ 32767	Counter (CNT)
W	T	DDDD	0 ~ 32767	Timer (TIM)
W	D	DDDD	0 ~ 32767	Data Memory (DM)
W	EM0 ~ EMC	DDDD	0 ~ 32767	Extend Memory

Wiring Diagram:

Ethernet cable:



OMRON EtherNet/IP (NJ/NX Series)

Supported Series: OMRON EtherNet/IP NJ / NX1P Series PLC

Website: <http://www.omron.com/>

HMI Setting:

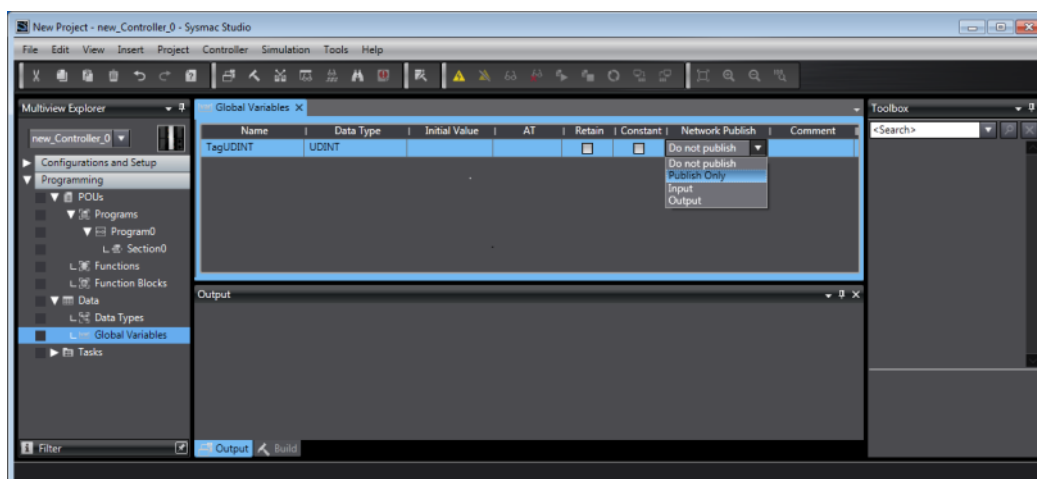
Parameters	Recommended	Options	Notes
PLC type	OMRON EtherNet/IP (NJ Series)		
PLC I/F	Ethernet		
Port no.	44818		
PLC sta. no.	1		

On-line simulator	Yes	Multi-HMI connect	Yes
--------------------------	-----	--------------------------	-----

Instructions:

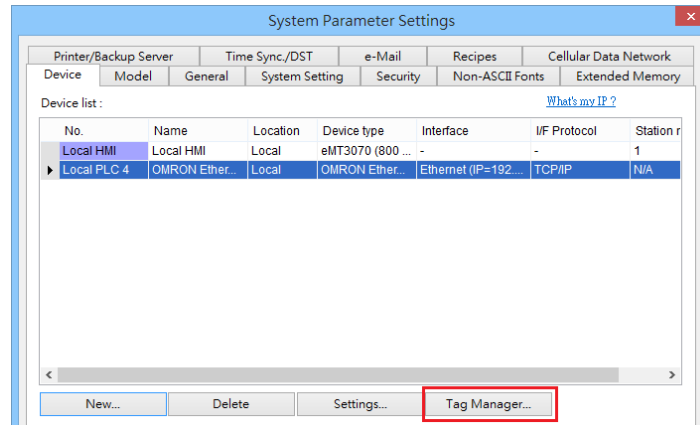
Note:

1. In Sysmac Studio, please select **[Publish Only]** for **[Network Publish]** when setting address tag.
2. When **[Do not publish]** is selected for a tag, different import methods may lead to different results. When import tags by **[Get Tags from Device]**, the tag will be eliminated. If **[Import tags]** is selected, the tags will be imported, but the communication will not succeed.

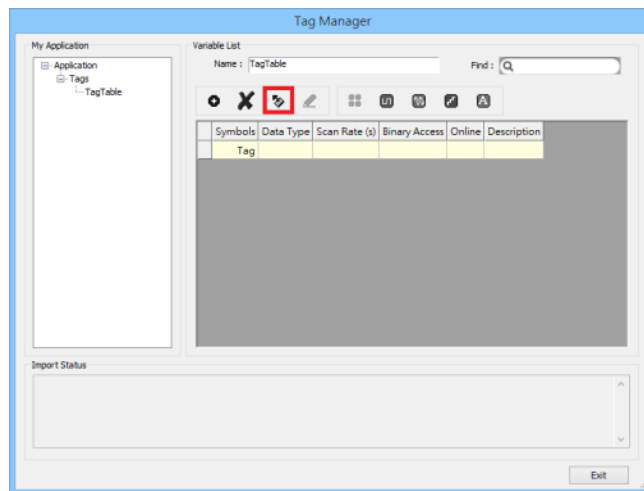


Get Tags from Network

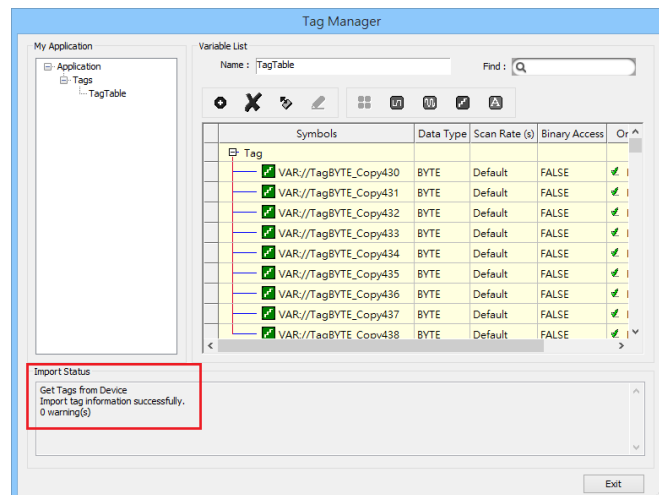
1. In EasyBuilder, open System Parameter Settings, and add **Omron EtherNet/IP (NJ series)**. Set communication parameters, and then click **[Tag Manager]**.



2. Click **[Get Tags]** » **[Get Tags from Device]**.

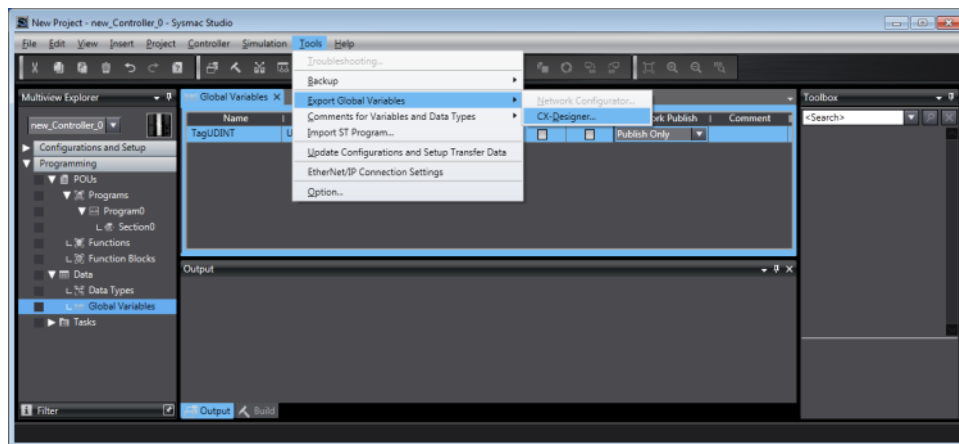


3. The **Import Status** field shows the result, click **[Exit]** to finish importing address tags.

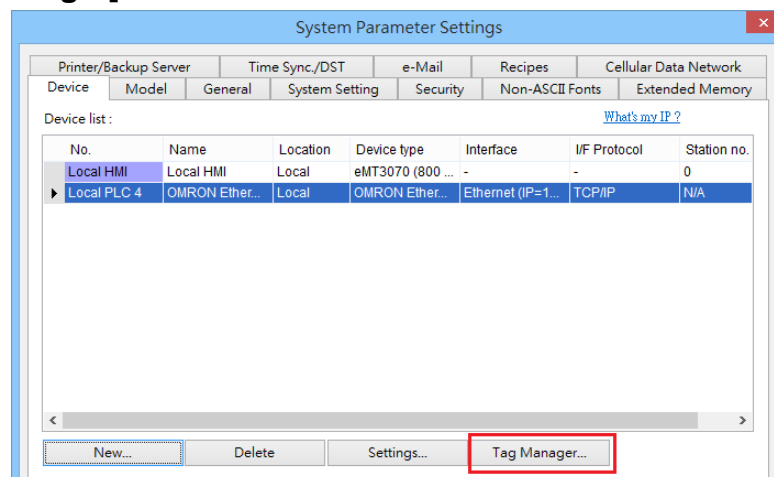


Export Tags from Sysmac Studio

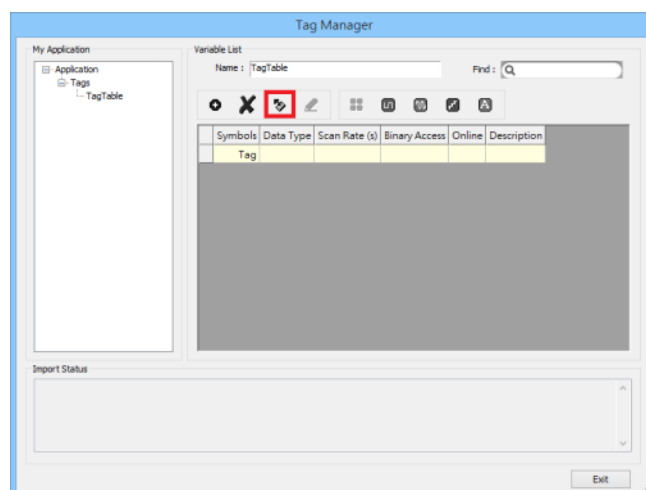
1. Launch Sysmac Studio, under Global Variables create the address tags, and then select **[Tools] » [Export Global Variables]**.



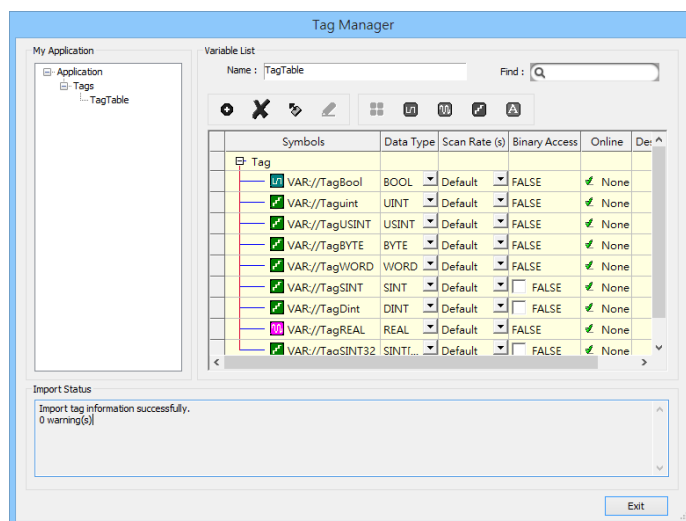
2. Launch EasyBuilder, in System Parameter Settings add **Omron EtherNet/IP (NJ series)**.
3. Click **[Tag Manager]**.



4. Click **[Get Tags] » [Import Tags]** and then select the file exported in step 1.



5. The **Import Status** field shows the result, click **[Exit]** to finish importing address tags.



- Supported data types include: BOOL, SINT, BYTE, USINT, INT, WORD, UINT, DINT, REAL, UDINT and DWORD. These data types support one-dimensional array.

Support Device Type:

Data type	EasyBuilder data format	Memo
Bool	bit	
Byte	16-bit BCD, Hex, Binary, Unsigned	8-bit
SInt	16-bit BCD, Hex, Binary, Signed	8-bit
USInt	16-bit BCD, Hex, Binary, Unsigned	8-bit
Word	16-bit BCD, Hex, Binary, Unsigned	16-bit
Int	16-bit BCD, Hex, Binary, Signed	16-bit
UInt	16-bit BCD, Hex, Binary, Unsigned	16-bit
DWord	32-bit BCD, Hex, Binary, Unsigned	32-bit
DInt	32-bit BCD, Hex, Binary, Signed	32-bit
Real	32-bit Float	32-bit
UDInt	32-bit BCD, Hex, Binary, Unsigned	32-bit
Array	Word array for ASCII input and ASCII display	Length=word

Wiring Diagram:

Ethernet cable:



OMRON Host Link

Supported Series: OMRON C, CPM, CPL, CQM Series (Host Link Protocol)

Website: <http://www.omron.com/>

HMI Setting:

Parameters	Recommended	Options	Notes
PLC type	OMRON Host Link		
PLC I/F	RS232	RS232, RS422, RS485	
Baud rate	9600	9600, 19200	
Data bits	7	7 or 8	
Parity	Even	Even, Odd, None	
Stop bits	2	1 or 2	
PLC sta. no.	0	0-31	Host Link Station No.

Online simulator	YES	Broadcast command	YES
Extend address mode	YES		

PLC Setting:

Communication mode	Host Link Protocol
--------------------	--------------------

Device Address:

Bit/Word	Device type	Format	Range	Memo
B	IR	DDDDdd	0 ~ 409515	I/O and Internal Relay
B	HR	DDDDdd	0 ~ 409515	Hold Relay
B	LR	DDDDdd	0 ~ 409515	Link Relay
B	IR (Force Set/Reset)	DDDDdd	0 ~ 409515	
B	HR (Force Set/Reset)	DDDDdd	0 ~ 409515	
B	LR (Force Set/Reset)	DDDDdd	0 ~ 409515	
B	AR	DDDDdd	0 ~ 409515	Auxiliary Relay
W	AR_W	DDDD	0 ~ 4095	
W	IR_W	DDDD	0 ~ 4095	
W	HR_W	DDDD	0 ~ 4095	
W	LR_W	DDDD	0 ~ 4095	
W	TC	DDD	0 ~ 255	

Bit/Word	Device type	Format	Range	Memo
W	DM	DDDD	0 ~ 9999	Data Register

Wiring Diagram:

CPU Port (CPM2A,CQM1/1H,C200H/HS/ALPHA series)

Communication Module:

CPM1-CIF01 adapter (for CPM1/CPM1A/CPM2A series, CQM1/CQM1H series)

CPM1H-SCB41 communication module (for CQM1H-CPU51/61)

RS-232 9P D-Sub (Diagram 1 ~ Diagram 3)

Diagram 1

cMT Series	<i>cMT3151</i>
eMT Series	<i>eMT3070 / eMT3105 / eMT3120 / eMT3150</i>
MT-iE	<i>MT8073iE / MT8102iE</i>
MT-XE	<i>MT8092XE</i>
MT-iP	<i>MT6103iP</i>

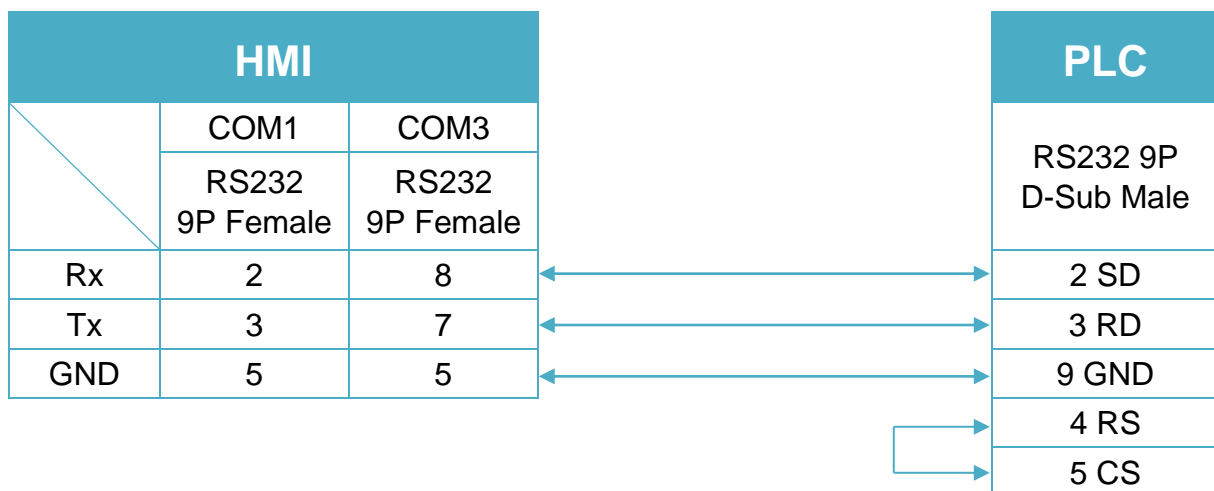


Diagram 2

cMT Series	cMT-SVR
mTV	mTV
MT-iE	MT8070iE / MT6070iE / MT8100iE / MT8121iE / MT8150iE / MT8071iE / MT6071iE / MT8072iE / MT6072iE / MT8073iE / MT8101iE / MT8102iE / MT8103iE
MT-XE	MT8121XE / MT8150XE / MT8090XE

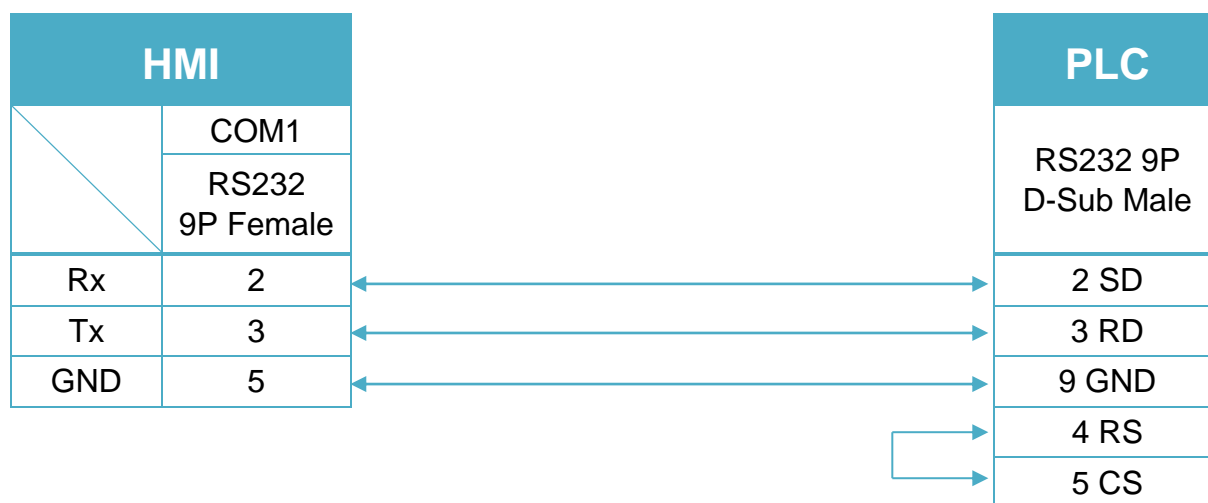
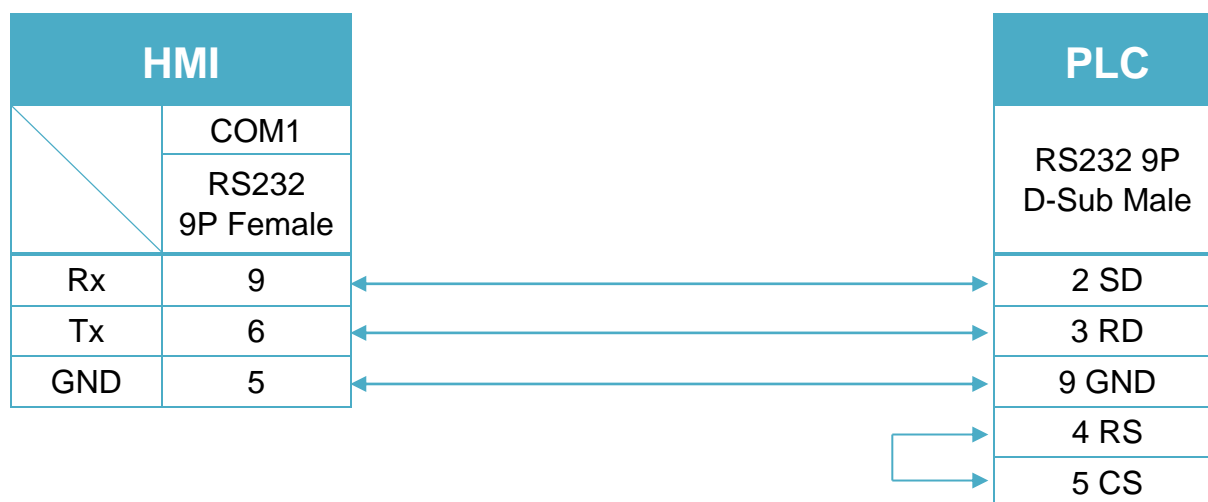


Diagram 3

MT-iE	MT8050iE
MT-iP	MT6051iP / MT6071iP / MT8071iP



C200h-LK201,3G2A6-LK201 communication module
 C200HW-COM02/03/04/05/06 communication module

RS-232 9P D-Sub (Diagram 4 ~ Diagram 6)

Diagram 4

cMT Series	<i>cMT3151</i>
eMT Series	<i>eMT3070 / eMT3105 / eMT3120 / eMT3150</i>
MT-iE	<i>MT8073iE / MT8102iE</i>
MT-XE	<i>MT8092XE</i>
MT-iP	<i>MT6103iP</i>

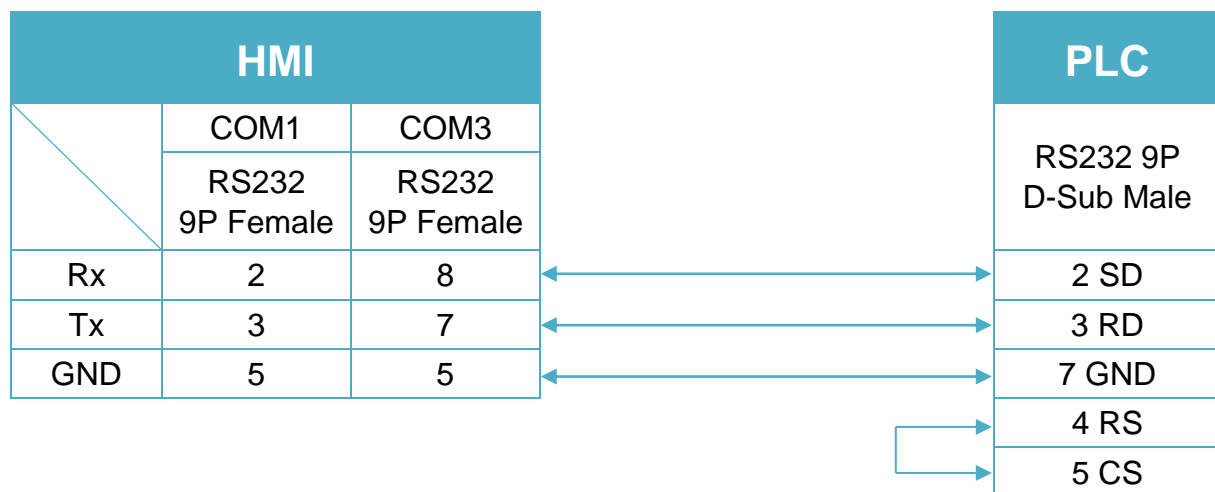


Diagram 5

cMT Series	cMT-SVR
mTV	mTV
MT-iE	MT8070iE / MT6070iE / MT8100iE / MT8121iE / MT8150iE / MT8071iE / MT6071iE / MT8072iE / MT6072iE / MT8073iE / MT8101iE / MT8102iE / MT8103iE
MT-XE	MT8121XE / MT8150XE / MT8090XE

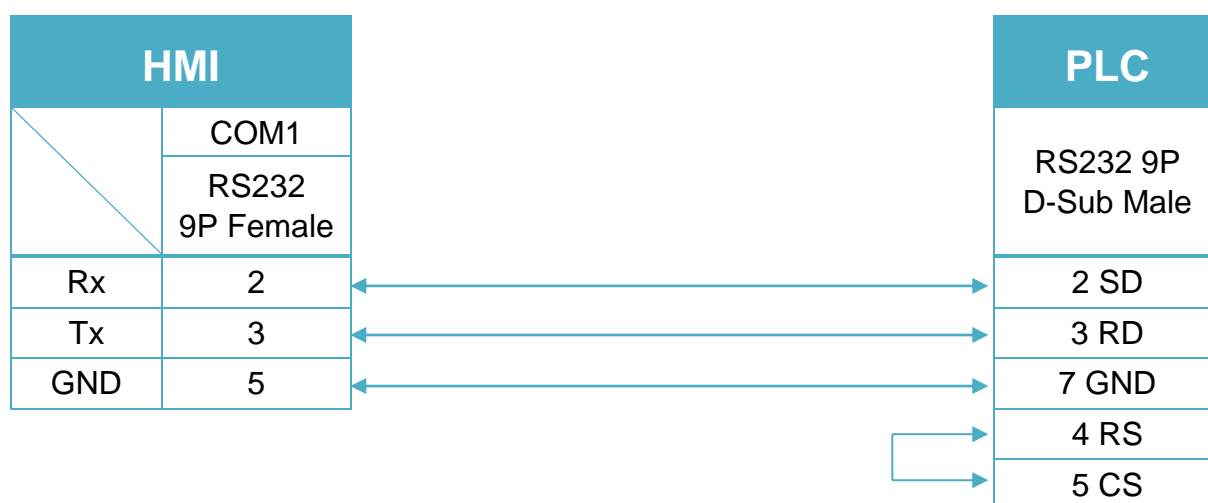
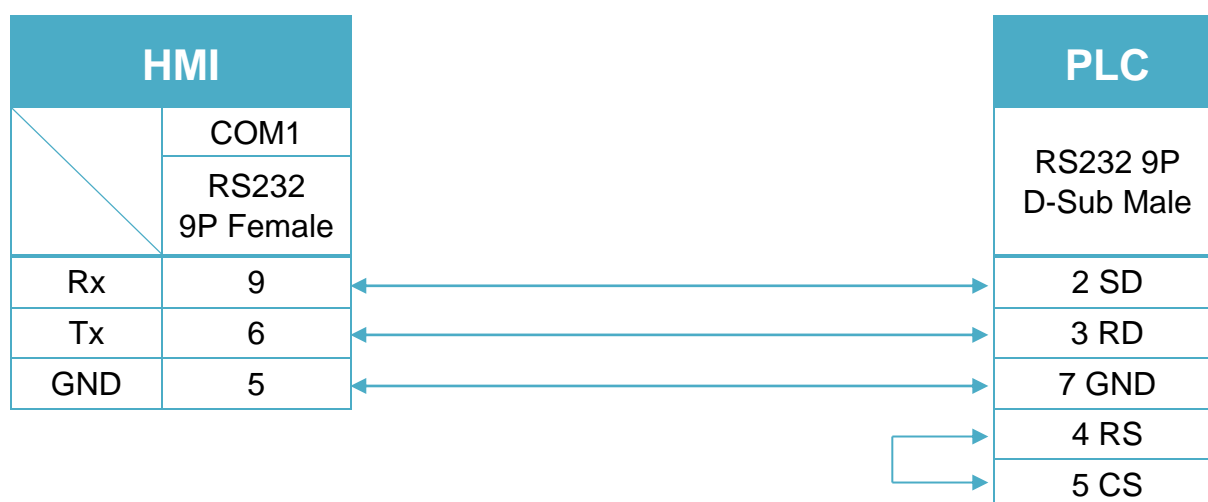


Diagram 6

MT-iE	MT8050iE
MT-iP	MT6051iP / MT6071iP / MT8071iP



OPC UA Client

Supported Series: Weinete OPC UA Server, Unified Automation, Prosys, Kepware

HMI Setting:

Parameters	Recommended	Options	Notes
PLC type	OPC UA Client		
PLC I/F	Ethernet		
Port no.	4840		
Security policy	None	None / Basic128Rsa15 / Basic256 /	
Message security mode	None	None / Sign/ SignAndEncrypt	

On-line simulator	Yes	Multi-HMI connect	Yes
--------------------------	-----	--------------------------	-----

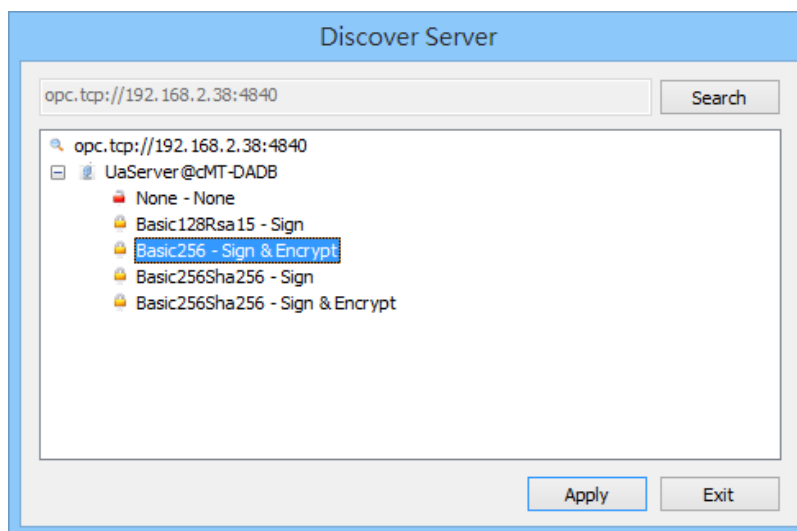
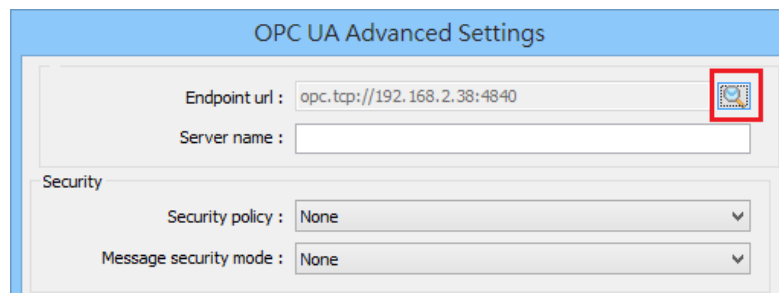
Support Device Type:

Data type	EasyBuilder data format	Memo
Bool	bit	
Int	16-bit BCD, Hex, Binary, Signed	16-bit
UInt	16-bit BCD, Hex, Binary, Unsigned	16-bit
DInt	32-bit BCD, Hex, Binary, Signed	32-bit
Real	32-bit Float	32-bit
UDInt	32-bit BCD, Hex, Binary, Unsigned	32-bit

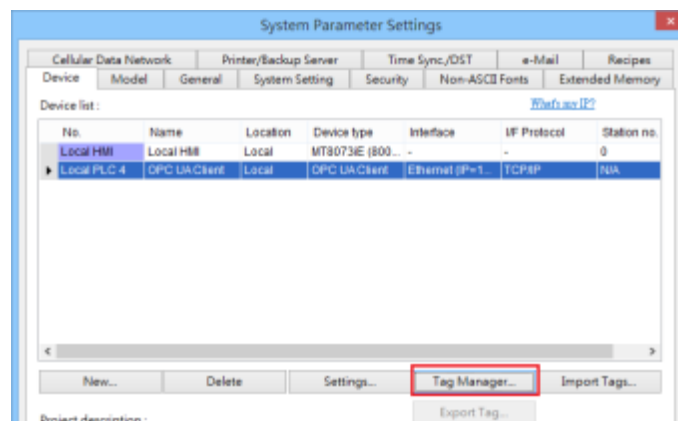
Get Tags:

1. In EasyBuilder Pro, add OPC UA Client into the device list, set **[IP address]**, **[Port no.]**, and then open **[Security, Authentication]**.

2. Click the magnifier icon near the **[Endpoint url]** field to open Discover Server window. In the window the security parameters of OPC UA Server can be found. Click **[Apply]**, the parameters will be automatically filled into the fields in Security group box in OPC UA Settings window. Finish the rest of the settings and then click **[OK]** to leave.



3. Click Tag Manager. If **“Connection failed.”** message appears, please check the communication parameters.

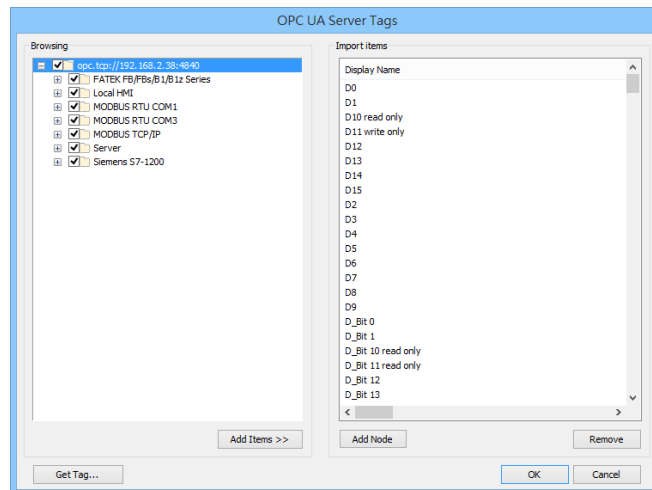


4. In the Browsing list select the tags to be imported, click **[Add Items]** to add the selected ones into **[Import items]** list. Click **OK** to save and leave, and “**Get tag information successfully.**” message will show.

Get tag: Get tag information again.

Remove: Remove tag information.

Add Node: Add tag manually.



Wiring Diagram:

Ethernet cable:



OPTO22 CONT Protocol (Ethernet)

Supported Series: OPTO22 SNAP PAC System

Website: <http://www.opto22.com/>

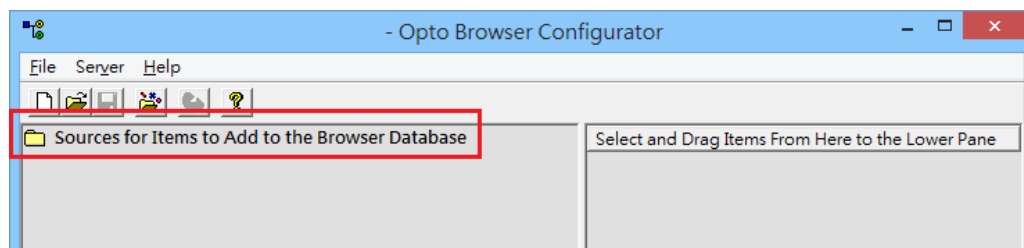
HMI Setting:

Parameters	Recommended	Options	Notes
PLC type	OPTO22 CONT Protocol (Ethernet)		
PLC I/F	Ethernet		
Port no.	22001		

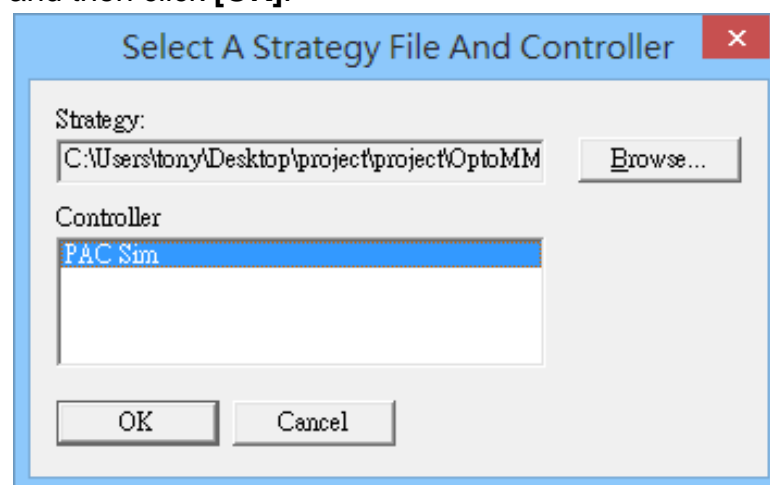
On-line simulator	Yes	Multi-HMI connect	Yes
--------------------------	-----	--------------------------	-----

Import Tags:

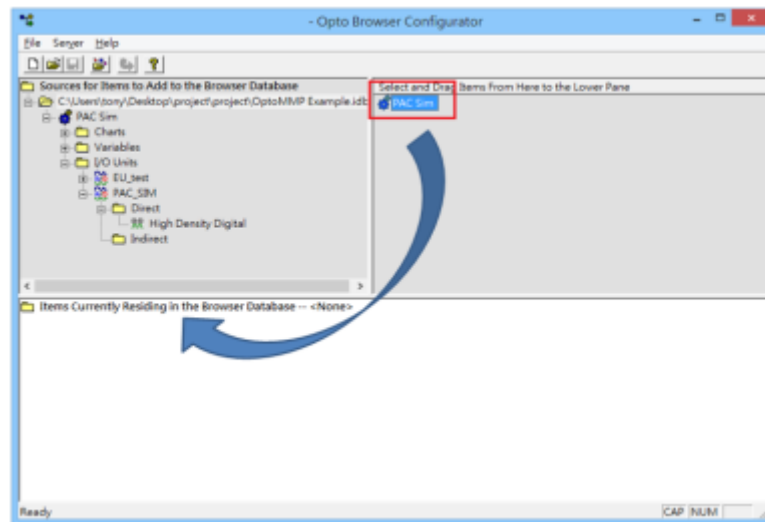
1. Open Browser Configurator, double click on **[Source for Items to Add to the Browser Database]**, and then select the PLC project containing the tags for export.



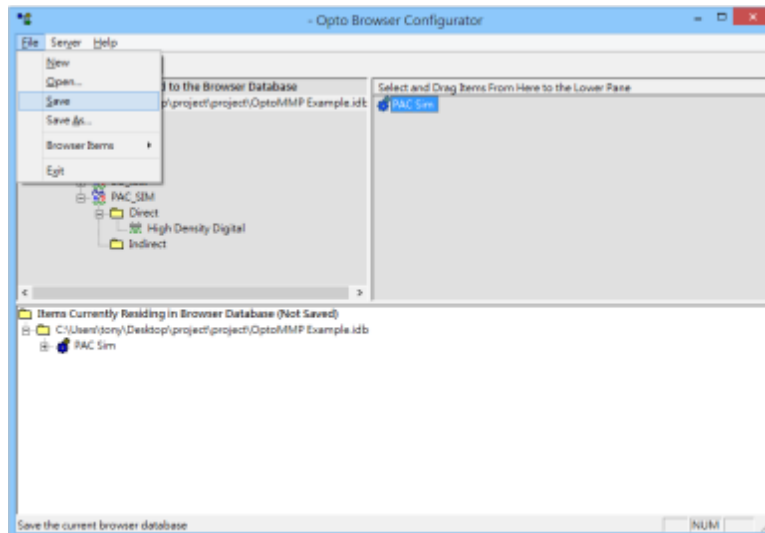
2. Select a controller and then click **[OK]**.



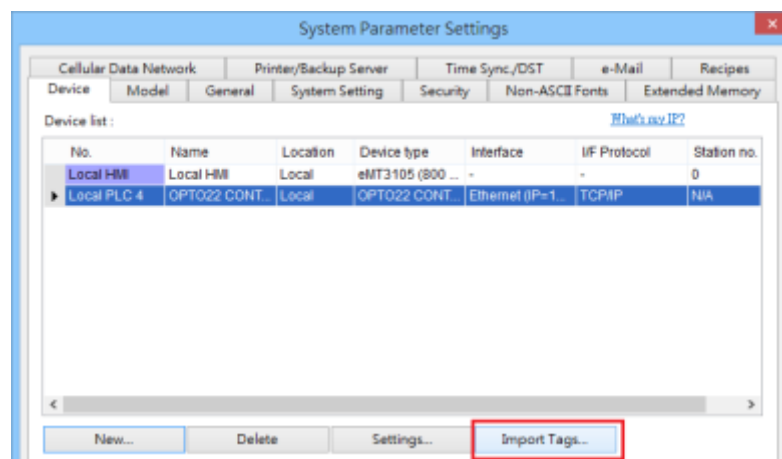
3. Drag the items from the right pane to the lower pane.



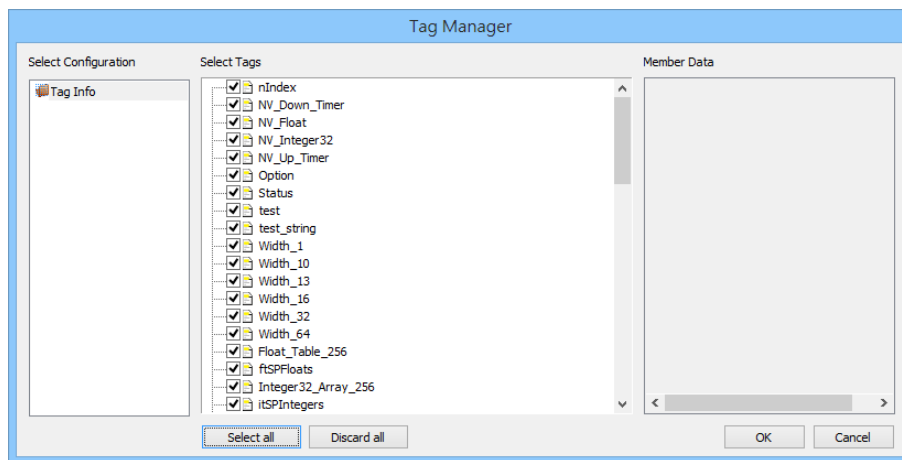
4. Name the tag file and then click **[File] » [Save]**.



5. Launch EasyBuilder Pro, add “**OPTO22 CONT Protocol (Ethernet)**” driver into the device list, set the communication parameters, and then click **[Import Tags]**.



6.Tag Manager opens after selecting a tag file. Click **[Select all]** to select all tags or select certain tags by clicking their checkboxes. Click **[OK]** to import the selected tags. **“Import tag information successfully.”** message shows when the tags are imported successfully.



Support Device Type:

Data type	EasyBuilder data format	Memo
Bool	bit	
DInt	32-bit BCD, Hex, Binary, Signed	32-bit
Real	32-bit Float	32-bit
String	ASCII input and ASCII display	Length=word

Wiring Diagram:

Ethernet cable:



OPTO22 MMIO Protocol (Ethernet)

Supported Series: OPTO22 SNAP PAC System

Website: <http://www.opto22.com/>

HMI Setting:

Parameters	Recommended	Options	Notes
PLC type	OPTO22 MMIO Protocol (Ethernet)		
PLC I/F	Ethernet		
Port no.	2001		

On-line simulator	Yes	Multi-HMI connect	Yes
-------------------	-----	-------------------	-----

Device Address:

Bit/Word	Device type	Format	Range	Memo
B	STATE	DD	0 ~ 63	Read / Write
B	ONLATCH	DD	0 ~ 63	Read
B	OFFLATCH	DD	0 ~ 63	Read
B	ACTIVECOUNTER	DD	0 ~ 63	Read / Write
B	ONLATCH_READCLEAR	DD	0 ~ 63	Read
B	OFFLATCH_READCLEAR	DD	0 ~ 63	Read
B	HDD_STATE	DDdd	0 ~ 1531	Read / Write
B	HDD_ONLATCH	DDdd	0 ~ 1531	Read
B	HDD_OFFLATCH	DDdd	0 ~ 1531	Read
B	HDD_ONLATCH_CLEAR	DDdd	0 ~ 1531	Write
B	HDD_OFFLATCH_CLEAR	DDdd	0 ~ 1531	Write
B	ALARM_HI_STATE	DD	0 ~ 63	Read
B	ALARM_HI_ENABLE	DD	0 ~ 63	Read / Write
B	ALARM_LO_STATE	DD	0 ~ 63	Read
B	ALARM_LO_ENABLE	DD	0 ~ 63	Read / Write
B	SP_BIT	DD	0 ~ 63	Read / Write
DW	EU	DD	0 ~ 63	Read / Write
DW	COUNTS	DD	0 ~ 63	Read / Write
DW	MIN	DD	0 ~ 63	Read
DW	MAX	DD	0 ~ 63	Read
DW	MIN_READCLEAR	DD	0 ~ 63	Read

Bit/Word	Device type	Format	Range	Memo
DW	MAX_READCLEAR	DD	0 ~ 63	Read
DW	EU_4096	DDDD	0 ~ 4095	Read / Write
DW	COUNTS_4096	DDDD	0 ~ 4095	Read / Write
DW	MIN_4096	DDDD	0 ~ 4095	Read
DW	MAX_4096	DDDD	0 ~ 4095	Read
DW	MIN_READCLEAR_4096	DDDD	0 ~ 4095	Read
DW	MAX_READCLEAR_4096	DDDD	0 ~ 4095	Read
DW	COUNTERDATA	DD	0 ~ 63	Read
DW	COUNTERDATA_READCLEAR	DD	0 ~ 63	Read
DW	HDD_COUNTER	DDdd	0 ~ 1531	Read
DW	HDD_COUNTER_READCLEAR	DDdd	0 ~ 1531	Read
DW	HDD_BANK_STATE	DD	0 ~ 15	Read / Write
DW	HDD_BANK_ONLATCH	DD	0 ~ 15	Read
DW	HDD_BANK_OFFLATCH	DD	0 ~ 15	Read
DW	HDD_BANK_ONLATCH_CLEAR	DD	0 ~ 15	Write
DW	HDD_BANK_OFFLATCH_CLEAR	DD	0 ~ 15	Write
DW	MODULETYPE	DD	0 ~ 63	Read
DW	POINTTYPE	DD	0 ~ 63	Read / Write
DW	FEATURE	DD	0 ~ 63	Read / Write
DW	OFFSET	DD	0 ~ 63	Read / Write
DW	GAIN	DD	0 ~ 63	Read / Write
DW	HISCALE	DD	0 ~ 63	Read / Write
DW	LOSCALE	DD	0 ~ 63	Read / Write
DW	MODULETYPE_4096	DDDD	0 ~ 4095	Read
DW	POINTTYPE_4096	DDDD	0 ~ 4095	Read / Write
DW	FEATURE_4096	DDDD	0 ~ 4095	Read / Write
DW	OFFSET_4096	DDDD	0 ~ 4095	Read / Write
DW	GAIN_4096	DDDD	0 ~ 4095	Read / Write
DW	HISCALE_4096	DDDD	0 ~ 4095	Read / Write
DW	LOSCALE_4096	DDDD	0 ~ 4095	Read / Write
DW	ALARM_HI_SETPOINT	DD	0 ~ 63	Read / Write
DW	ALARM_HI_DEADBAND	DD	0 ~ 63	Read / Write
DW	ALARM_LO_SETPOINT	DD	0 ~ 63	Read / Write
DW	ALARM_LO_DEADBAND	DD	0 ~ 63	Read / Write
DW	SP_INTEGER	DDDDD	0 ~ 10239	Read / Write
DW	SP_FLOAT	DDDDD	0 ~ 10239	Read / Write
W	SP_STRING	DDDD	0 ~ 6300	Read / Write

Bit/Word	Device type	Format	Range	Memo
DW	PID_CV_IN	DDD	0 ~ 127	Read
DW	PID_CV_SP	DDD	0 ~ 127	Read
DW	PID_CV_OUT	DDD	0 ~ 127	Read / Write
DW	PID_CV_FF	DDD	0 ~ 127	Read / Write
DW	PID_CV_ERROR	DDD	0 ~ 127	Read
DW	PID_CV_P	DDD	0 ~ 127	Read
DW	PID_CV_I	DDD	0 ~ 127	Read
DW	PID_CV_D	DDD	0 ~ 127	Read
DW	PID_CV_INTEGRAL	DDD	0 ~ 127	Read
DW	PID_LSV_IN	DDD	0 ~ 127	Read / Write
DW	PID_LSV_SP	DDD	0 ~ 127	Read / Write
DW	PID_STATUS	DDD	0 ~ 127	Read / Write
DW	PID_STATUS_ON	DDD	0 ~ 127	Read / Write
DW	PID_STATUS_OFF	DDD	0 ~ 127	Read / Write
DW	PID_TUNE_P	DDD	0 ~ 127	Read / Write
DW	PID_TUNE_I	DDD	0 ~ 127	Read / Write
DW	PID_TUNE_D	DDD	0 ~ 127	Read / Write
DW	PID_TUNE_FF	DDD	0 ~ 127	Read / Write
DW	PID_CFG_MAX_OUT	DDD	0 ~ 127	Read / Write
DW	PID_CFG_MIN_OUT	DDD	0 ~ 127	Read / Write
DW	PID_CFG_SCAN_TIME	DDD	0 ~ 127	Read / Write
DW	PID_CFG_LOW_RANGE	DDD	0 ~ 127	Read / Write
DW	PID_CFG_HI_RANGE	DDD	0 ~ 127	Read / Write
DW	PID_CFG_ALG	DDD	0 ~ 127	Read / Write
DW	PID_CFG_MAN_MODE	DDD	0 ~ 127	Read / Write
DW	PID_CFG_FLAGS	DDD	0 ~ 127	Read / Write
DW	PID_CFG_FLAGS_ON	DDD	0 ~ 127	Read / Write
DW	PID_CFG_FLAGS_OFF	DDD	0 ~ 127	Read / Write
DW	PID_CFG_MM_IN	DDD	0 ~ 127	Read / Write
DW	PID_CFG_MM_SP	DDD	0 ~ 127	Read / Write
DW	PID_CFG_MM_OUT	DDD	0 ~ 127	Read / Write
DW	PID_SCALE_IN_LOW	DDD	0 ~ 127	Read / Write
DW	PID_SCALE_IN_HI	DDD	0 ~ 127	Read / Write
DW	PID_SCALE_OUT_LOW	DDD	0 ~ 127	Read / Write
DW	PID_SCALE_OUT_HI	DDD	0 ~ 127	Read / Write
DW	PID_SCAN_COUNTER	DDD	0 ~ 127	Read / Write

Wiring Diagram:

Ethernet cable:



OuHua OHJX

Website: <http://www.ohjx.com/>

HMI Setting:

Parameters	Recommended	Options	Notes
PLC type	OuHua OHJX		
PLC I/F	RS-232		
Baud rate	9600	9600,19200	
Data bits	8		
Parity	Odd		
Stop bits	1		
PLC sta. no.	1		

Device Address:

Bit/Word	Device type	Format	Range	Memo
B	R100	Dh	0 ~ 1f	
B	R101	Dh	0 ~ 1f	
B	R102	Dh	0 ~ 1f	
B	R103	Dh	0 ~ 1f	
B	R104	Dh	0 ~ 1f	
B	R105	Dh	0 ~ 1f	
B	R106	Dh	0 ~ 1f	
B	R107	Dh	0 ~ 1f	
B	R108	Dh	0 ~ 1f	
B	R109	Dh	0 ~ 1f	
B	R110	Dh	0 ~ 1f	
B	R210	Dh	0 ~ 1f	
B	R310	Dh	0 ~ 1f	
W	SV	DDDD	0 ~ 9999	
W	EV	DDDDD	0 ~ 65535	
W	DT	DDDDD	0 ~ 9999	
W	LD	DDDD	0 ~ 8447	
W	WX	DDDD	0 ~ 9999	
W	WY	DDDD	0 ~ 9999	
W	WR	DDDD	0 ~ 9999	

Bit/Word	Device type	Format	Range	Memo
W	WL	DDDD	0 ~ 9999	
W	FL	DDDDD	0 ~ 99999	

Wiring Diagram:

The following is the view from the soldering point of a cable.



RS-232 9P D-Sub (Diagram 1 ~ Diagram 3)

Diagram 1

cMT Series	<i>cMT3151</i>
eMT Series	<i>eMT3070 / eMT3105 / eMT3120 / eMT3150</i>
MT-iE	<i>MT8073iE / MT8102iE</i>
MT-XE	<i>MT8092XE</i>
MT-iP	<i>MT6103iP</i>

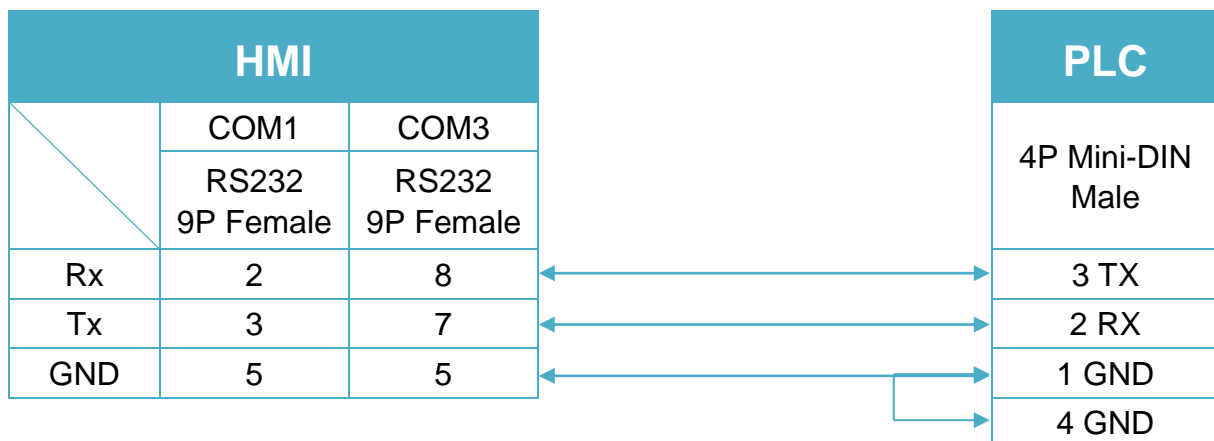


Diagram 2

cMT Series	cMT-SVR
mTV	mTV
MT-iE	MT8070iE / MT6070iE / MT8100iE / MT8121iE / MT8150iE / MT8071iE / MT6071iE / MT8072iE / MT6072iE / MT8073iE / MT8101iE / MT8102iE / MT8103iE
MT-XE	MT8121XE / MT8150XE / MT8090XE

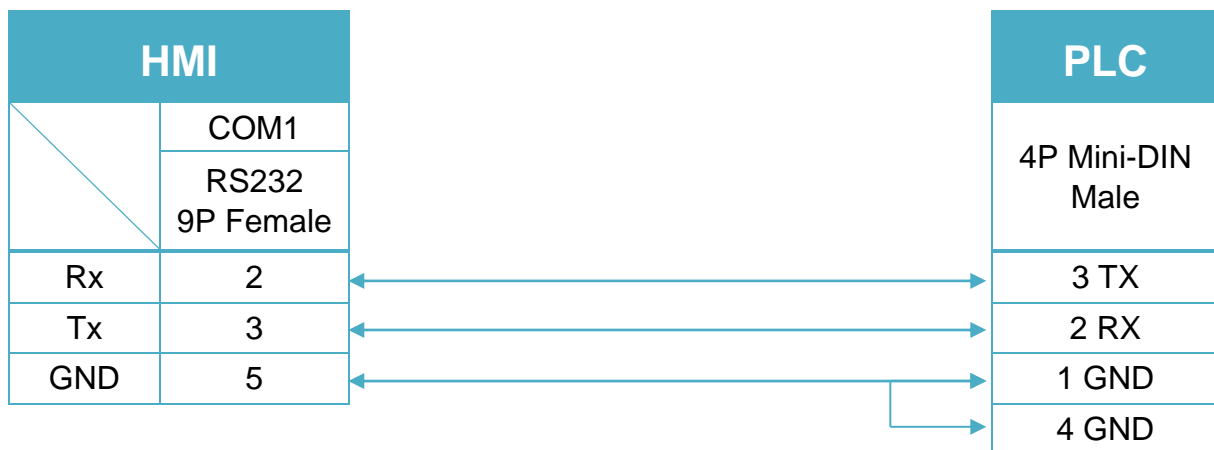
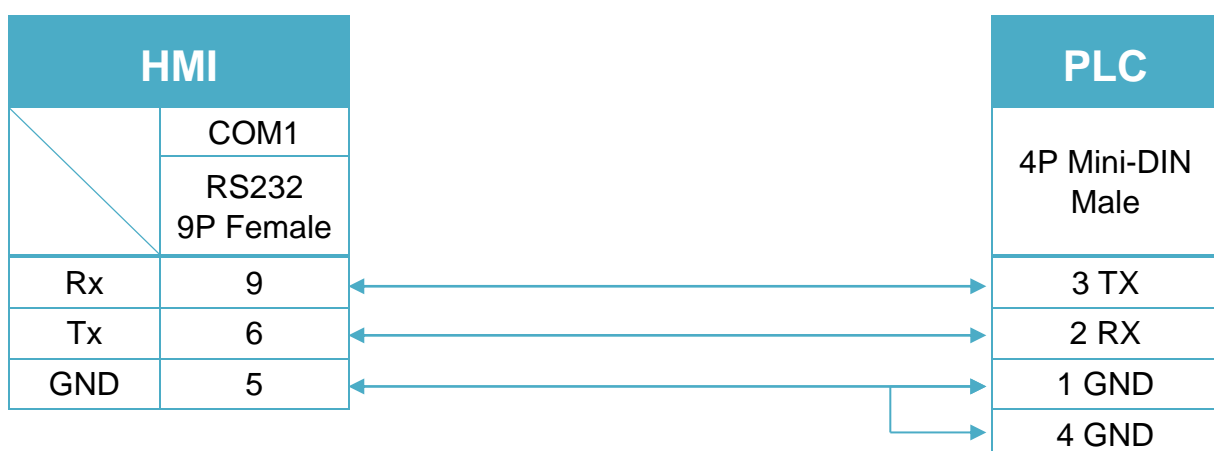


Diagram 3

MT-iE	MT8050iE
MT-iP	MT6051iP / MT6071iP / MT8071iP



Panasonic Eco-Power Meters

Supported Series: KW1M , KW1M-A , KW9M , KW9M-A

Website: <https://www.panasonic-electric-works.com/eu/>

HMI Setting:

Parameters	Recommended	Options	Notes
PLC type	Panasonic Eco-Power Meters		
PLC I/F	RS485 2W		
Baud rate	9600	9600 ~ 115200	
Data bits	8		
Parity	Odd		
Stop bits	1		
PLC sta. no.	1		

Support Device Type:

Data type	EasyBuilder data format	Memo
Bool	bit	
Byte	16-bit BCD, Hex, Binary, Unsigned	8-bit
SInt	16-bit BCD, Hex, Binary, Signed	8-bit
USInt	16-bit BCD, Hex, Binary, Unsigned	8-bit
Word	16-bit BCD, Hex, Binary, Unsigned	16-bit
Int	16-bit BCD, Hex, Binary, Signed	16-bit
UInt	16-bit BCD, Hex, Binary, Unsigned	16-bit
DWord	32-bit BCD, Hex, Binary, Unsigned	32-bit
DInt	32-bit BCD, Hex, Binary, Signed	32-bit
Real	32-bit Float	32-bit
UDInt	32-bit BCD, Hex, Binary, Unsigned	32-bit

Import Tags:

- The file for import must be built in **Easy Build Pro\Data Type\PanasonicPowerMeter** folder. The user can build the file according to the device types in advance, as shown below.

★ **Name** : User-defined tag name.

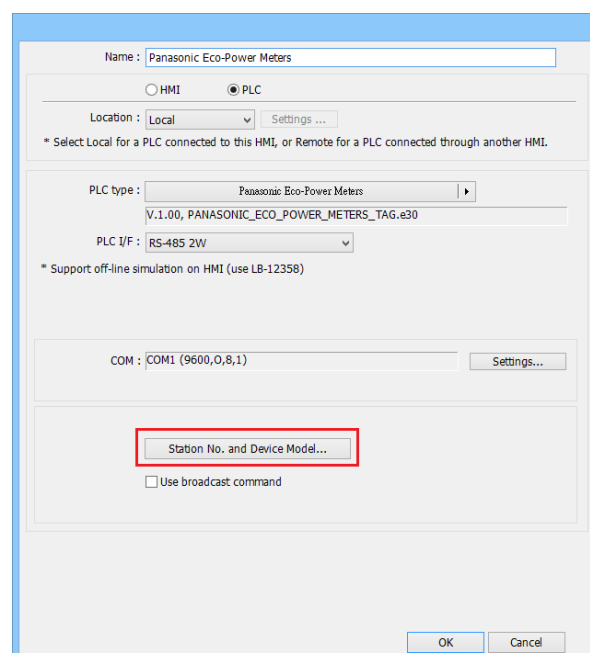
★ **Data** :Type: Define according to the data length and range.

★ **Address** : The address of the device.

★ **Description** : The description about the address.

Data type	Data length and range
BOOL	Bit
BYTE	8-bits Unsigned
WORD	16-bits Unsigned
DWORD	32-bits Unsigned
UDINT	32-bits Unsigned
UINT	16-bits Unsigned
USINT	8-bits Unsigned
SINT	8-bits Signed
INT	16-bits Signed
DINT	32-bits Signed
REAL	32-bits Float

- In EasyBuilder select [**Panasonic Eco-Power Meters**] driver, and then click [**Station No. and Device Model**].



- [Station no.]**: Set the station number according to the device, the range is 1~99.

[Name]: The name of the device.

[Model]: The models with their address tag files saved in **Easy Build Pro\Data Type\PanasonicPowerMeter** can be found in the drop down list.

[Add]: Add a new model.

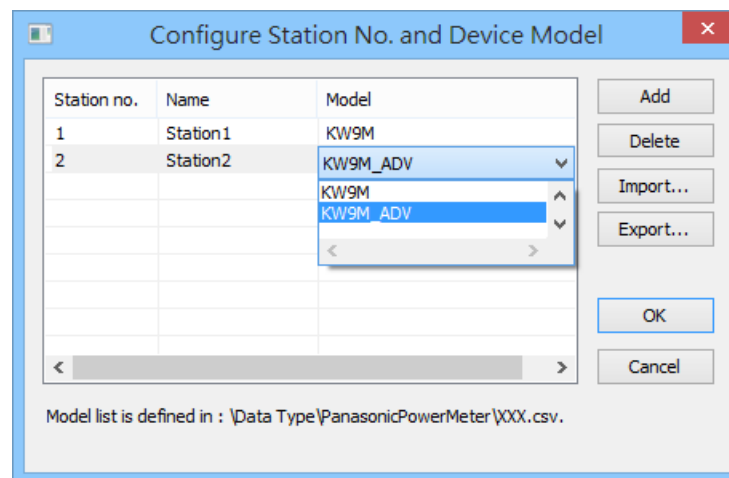
[Delete]: Delete a model. (At least one model should exist in the list.)

[Import]: Import the .dat file of the model.

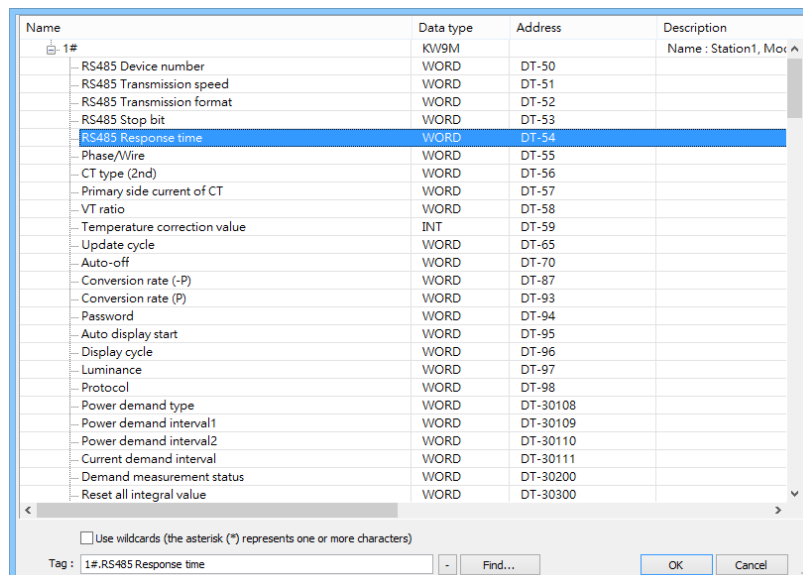
[Export]: Export the .dat file of the model.

[OK]: Save and leave.

[Cancel]: Don't save and leave.



- The imported address tags can be selected in object settings window.



Wiring Diagram:

Diagram 1

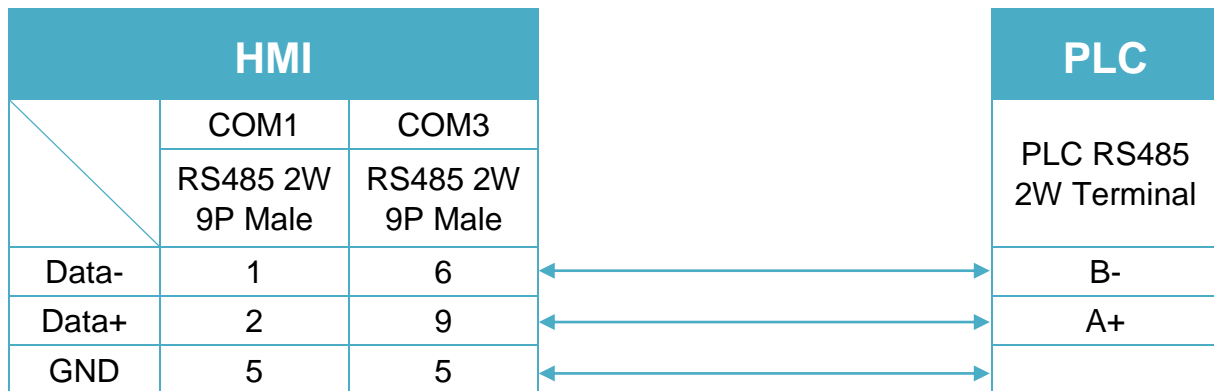
cMT Series
cMT3151
eMT Series
eMT3070 / eMT3105 / eMT3120 / eMT3150


Diagram 2

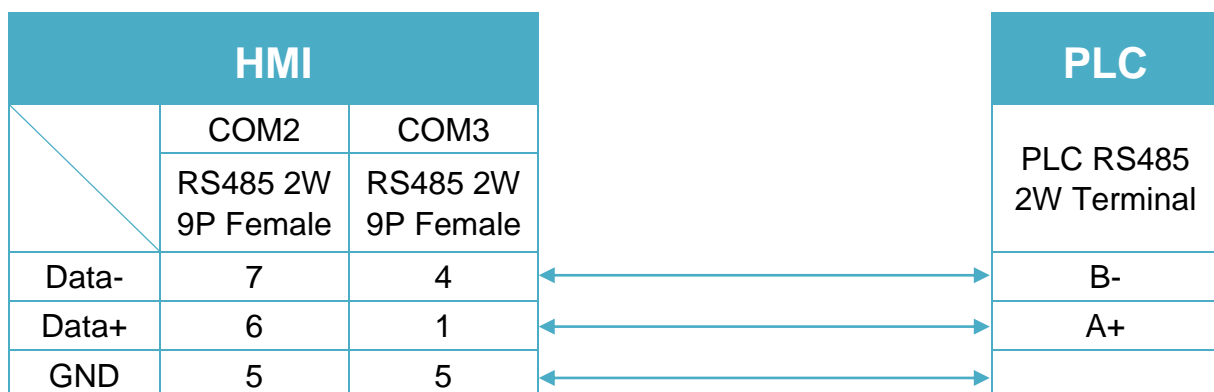
cMT Series
cMT-SVR
mTV
mTV


Diagram 3

MT-iE *MT8070iE / MT6070iE / MT8100iE / MT8121iE / MT8150iE*

MT-XE *MT8121XE / MT8150XE*

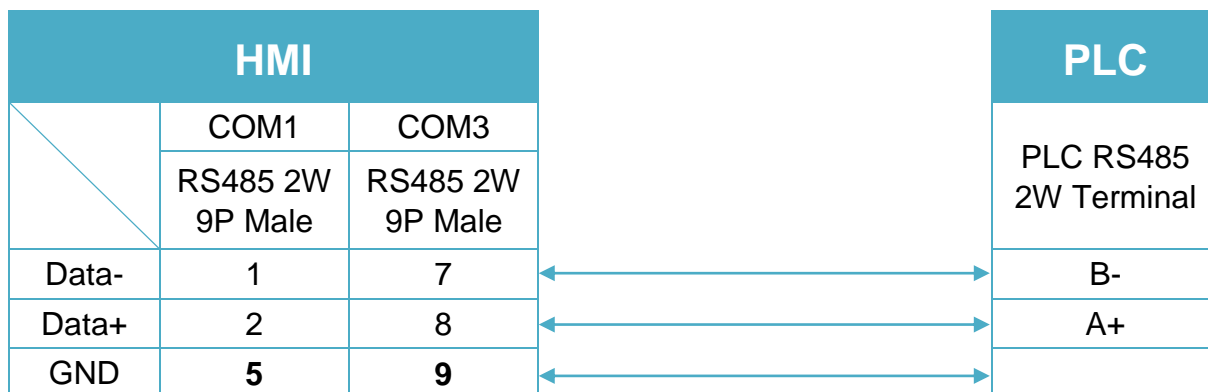


Diagram 4

MT-iE *MT8071iE / MT6071iE / MT8072iE / MT6072iE / MT8073iE / MT8101iE / MT8102iE / MT8103iE*

MT-XE *MT8090XE / MT8092XE*

MT-iP *MT6103iP*

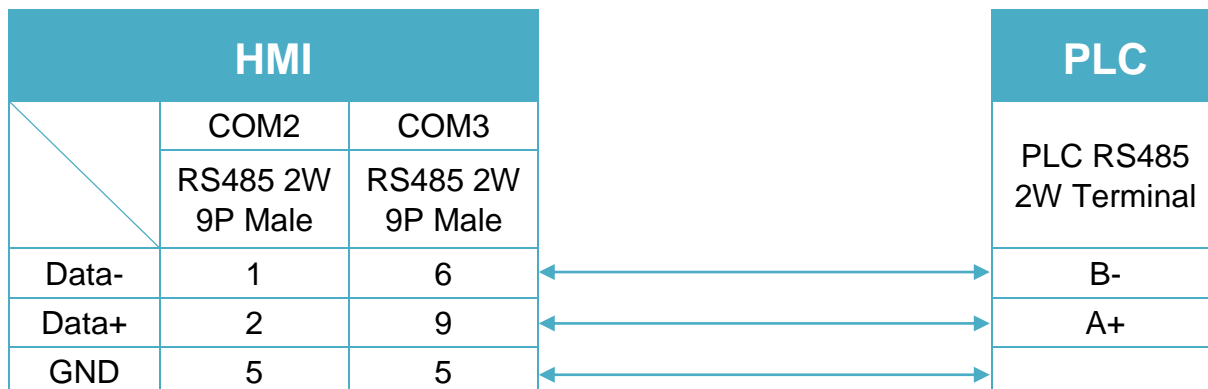


Diagram 5

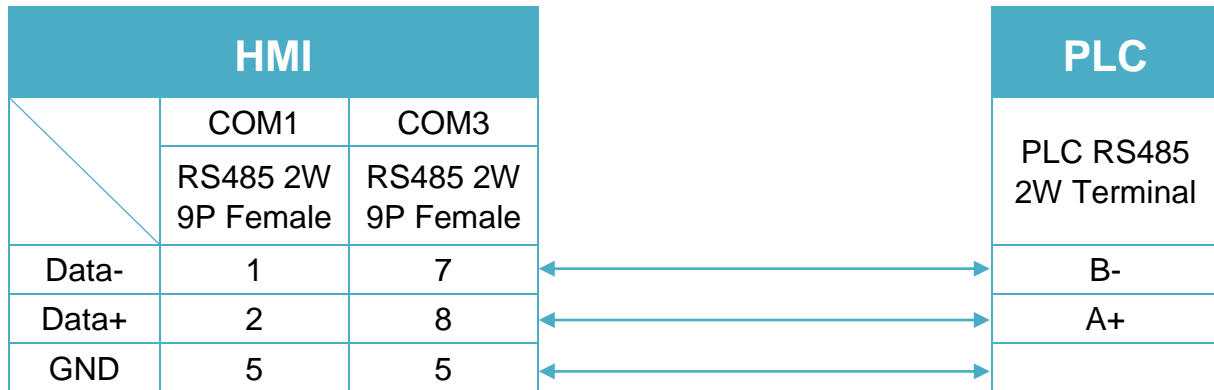
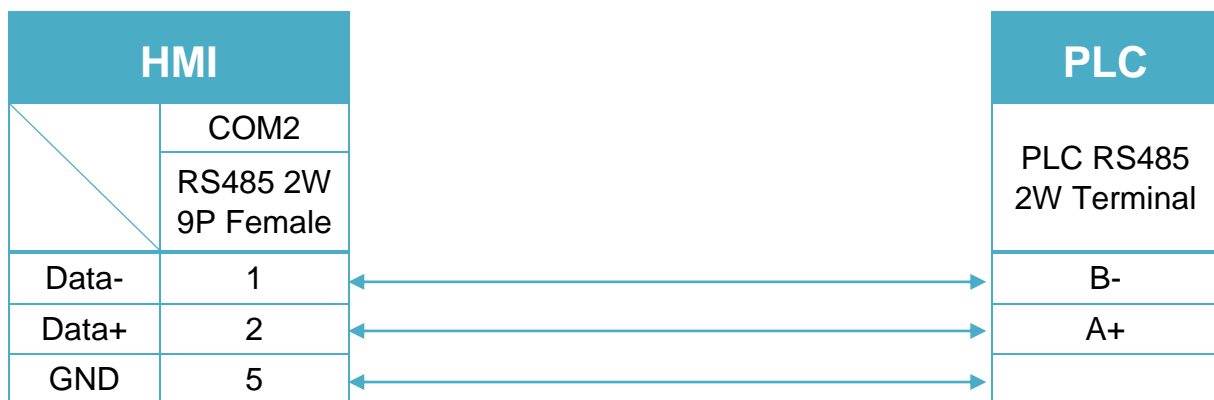
MT-iE *MT8050iE*
MT-iP *MT6051iP*


Diagram 6

MT-iP *MT6071iP / MT8071iP*


Panasonic FP/KW

Supported Series: NAIS (Matsushita) FP/KW series include FP-X, FP-XH, FP-Σ, FP0, FP1, FP2, FP2SH, FP10SH

Website: <http://pewa.panasonic.com/>

HMI Setting:

Parameters	Recommended	Options	Notes
PLC type	Panasonic FP/KW		
PLC I/F	RS232	RS232/RS485	
Baud rate	9600	9600, 19200, 38400,	
Data bits	8	7 or 8	
Parity	Odd	Even, Odd, None	
Stop bits	1	1 or 2	
PLC sta. no.	1	1-32	Must match the PLC port setting. FP3 must set to 0.

*Support communications between HMI and PLC in pass-through mode

*Set LW-9903 to 2 to enhance the speed of download/upload PLC program in pass-through mode

Device Address:

Bit/Word	Device type	Format	Range	Memo
B	X	DDDDh	0 ~ 9999f	Input (X)
B	Y	DDDDh	0 ~ 9999f	Output (Y)
B	R	DDDDh	0 ~ 9999f	Internal Relay (R)
B	L	DDDD	0 ~ 9999	Link Relay (L)
B	L_Bit	DDDDh	0 ~ 9999f	
B	T	DDDD	0 ~ 9999	Timer (T)
B	C	DDDD	0 ~ 9999	Counter (C)
W	SV	DDDD	0 ~ 9999	Timer/Counter Set Value (SV)
W	EV	DDDDD	0 ~ 65535	Timer/Counter Elapse Value (EV)
W	DT	DDDDDD	0 ~ 262143	Data Register (DT)
W	LD	DDDD	0 ~ 8447	Link Register (LD)
W	WX	DDDD	0 ~ 9999	Input (WX) (read only)
W	WY	DDDD	0 ~ 9999	Output (WY)
W	WR	DDDD	0 ~ 9999	Internal Relay (WR)

Bit/Word	Device type	Format	Range	Memo
W	WL	DDDD	0 ~ 9999	Link Relay (WL)
W	FL	DDDDD	0 ~ 99999	File Register (FL)

Wiring Diagram:

The following is the view from the soldering point of a cable.

FP0, FP2, FP2SH, FPM CPU : 9P D-Sub to 5P Mini-DIN (Diagram 1 ~ Diagram 3)

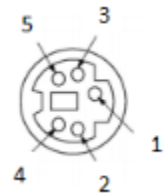


Diagram 1

cMT Series	<i>cMT3151</i>
eMT Series	<i>eMT3070 / eMT3105 / eMT3120 / eMT3150</i>
MT-iE	<i>MT8073iE / MT8102iE</i>
MT-XE	<i>MT8092XE</i>
MT-iP	<i>MT6103iP</i>

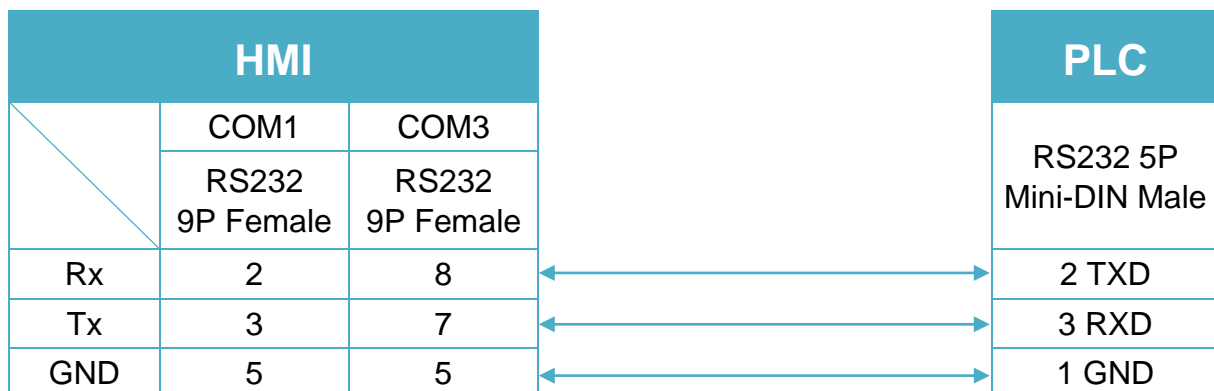


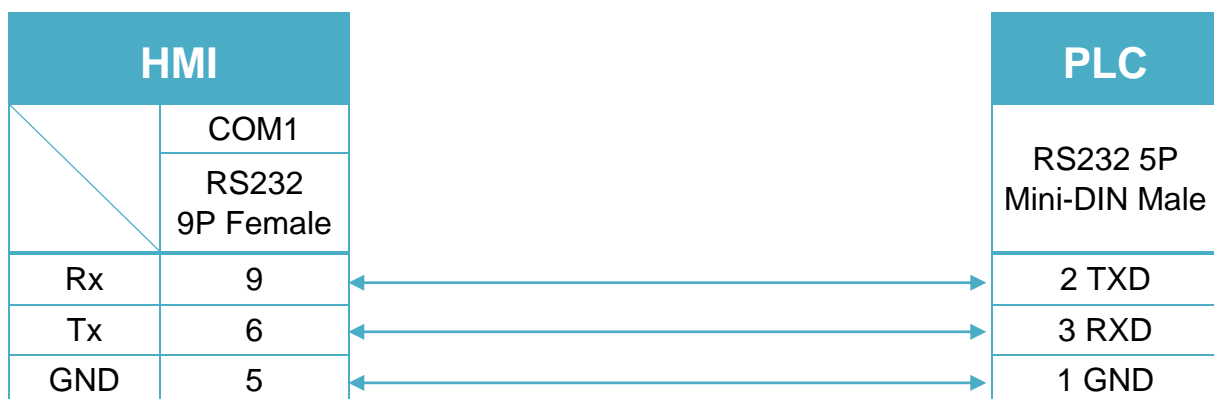
Diagram 2

cMT Series	cMT-SVR
mTV	mTV
MT-iE	MT8070iE / MT6070iE / MT8100iE / MT8121iE / MT8150iE / MT8071iE / MT6071iE / MT8072iE / MT6072iE / MT8073iE / MT8101iE / MT8102iE / MT8103iE
MT-XE	MT8121XE / MT8150XE / MT8090XE



Diagram 3

MT-iE	MT8050iE
MT-iP	MT6051iP / MT6071iP / MT8071iP



FP0 CPU : 9P D-Sub to 3P Terminal (Diagram 4 ~ Diagram 6)

Diagram 4

cMT Series	<i>cMT3151</i>
eMT Series	<i>eMT3070 / eMT3105 / eMT3120 / eMT3150</i>
MT-iE	<i>MT8073iE / MT8102iE</i>
MT-XE	<i>MT8092XE</i>
MT-iP	<i>MT6103iP</i>

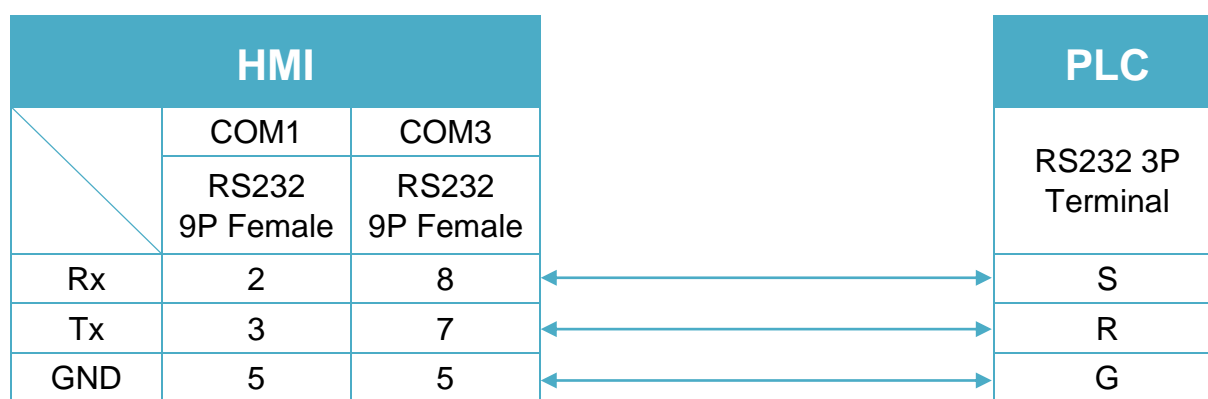


Diagram 5

cMT Series	<i>cMT-SVR</i>
mTV	<i>mTV</i>
MT-iE	<i>MT8070iE / MT6070iE / MT8100iE / MT8121iE / MT8150iE / MT8071iE / MT6071iE / MT8072iE / MT6072iE / MT8073iE / MT8101iE / MT8102iE / MT8103iE</i>
MT-XE	<i>MT8121XE / MT8150XE / MT8090XE</i>

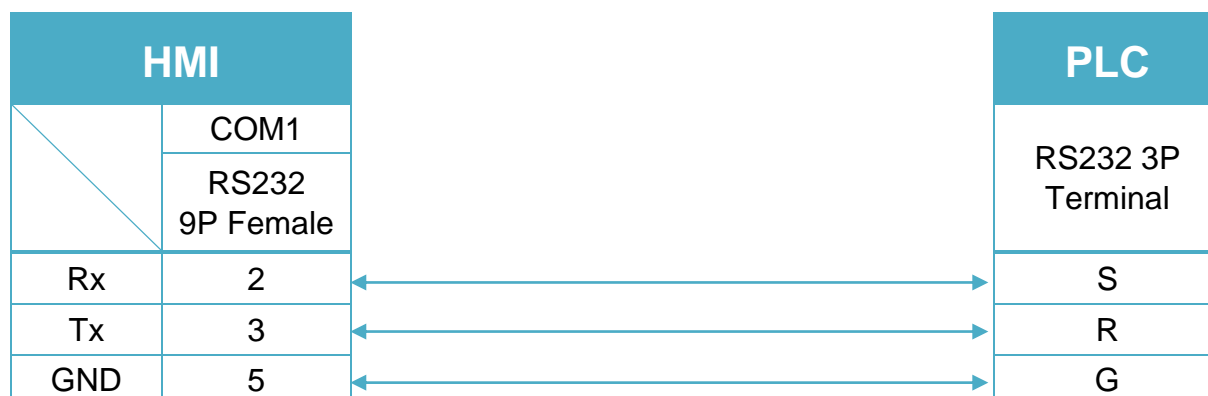
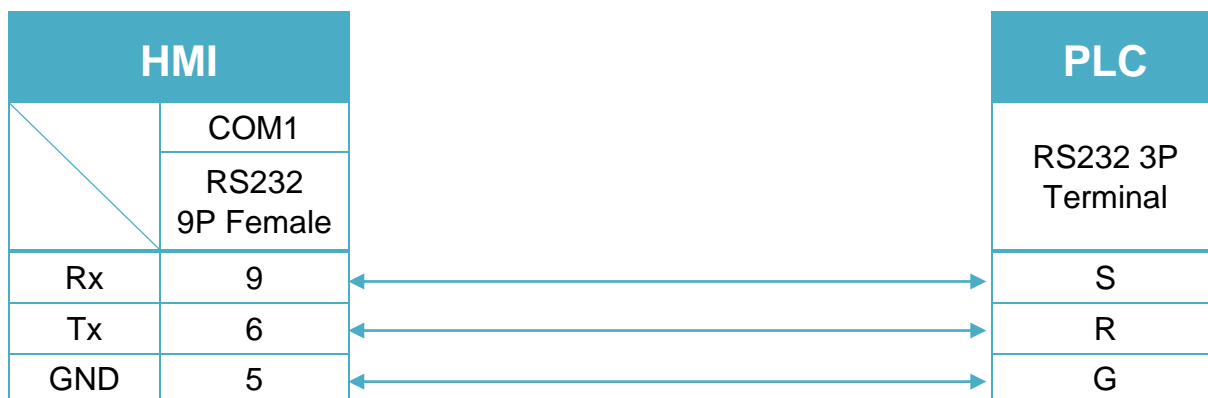


Diagram 6

MT-iE	<i>MT8050iE</i>
MT-iP	<i>MT6051iP / MT6071iP / MT8071iP</i>



RS232 9P D-Sub Male (Diagram 7 ~ Diagram 9)

Diagram 7

cMT Series	<i>cMT3151</i>
eMT Series	<i>eMT3070 / eMT3105 / eMT3120 / eMT3150</i>
MT-iE	<i>MT8073iE / MT8102iE</i>
MT-XE	<i>MT8092XE</i>
MT-iP	<i>MT6103iP</i>

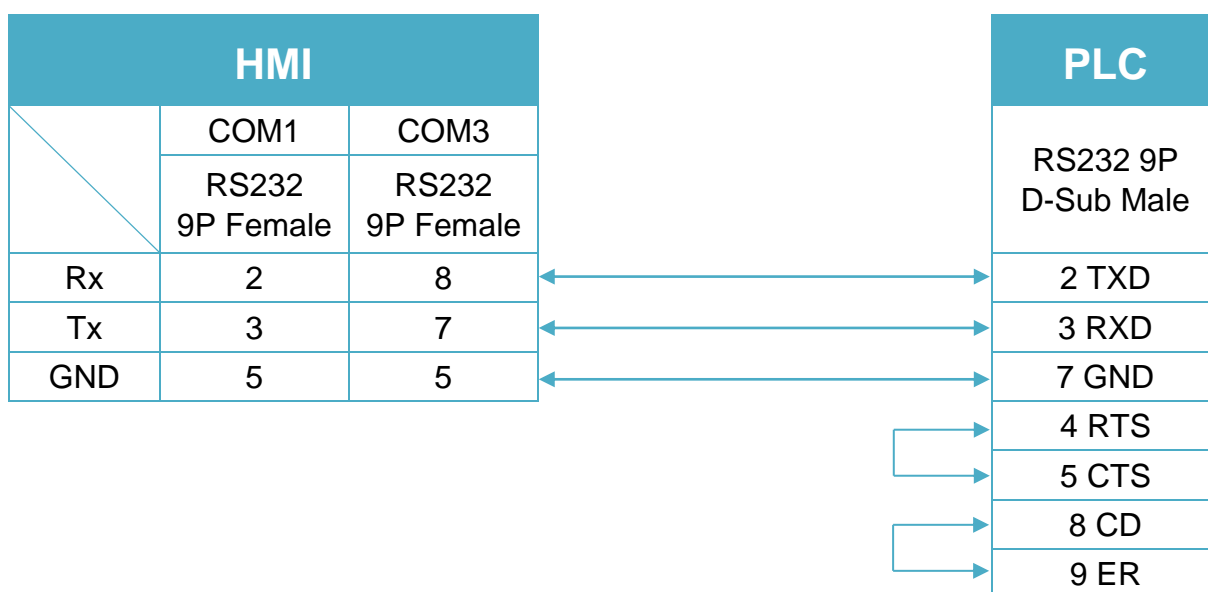


Diagram 8

cMT Series	cMT-SVR
mTV	mTV
MT-iE	MT8070iE / MT6070iE / MT8100iE / MT8121iE / MT8150iE / MT8071iE / MT6071iE / MT8072iE / MT6072iE / MT8073iE / MT8101iE / MT8102iE / MT8103iE
MT-XE	MT8121XE / MT8150XE / MT8090XE

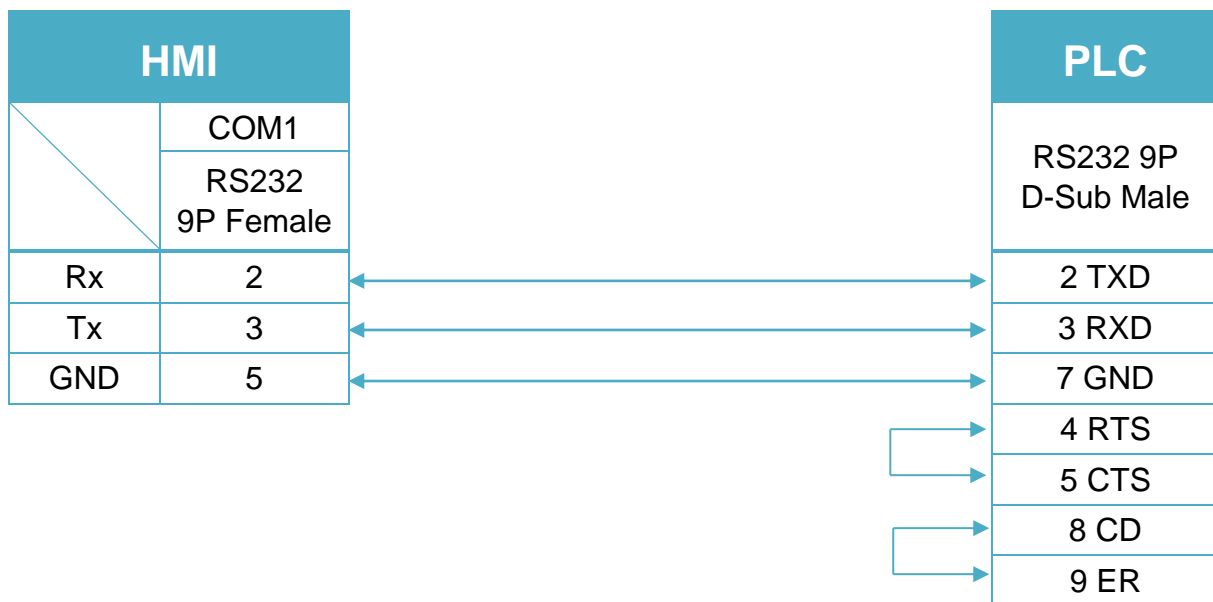
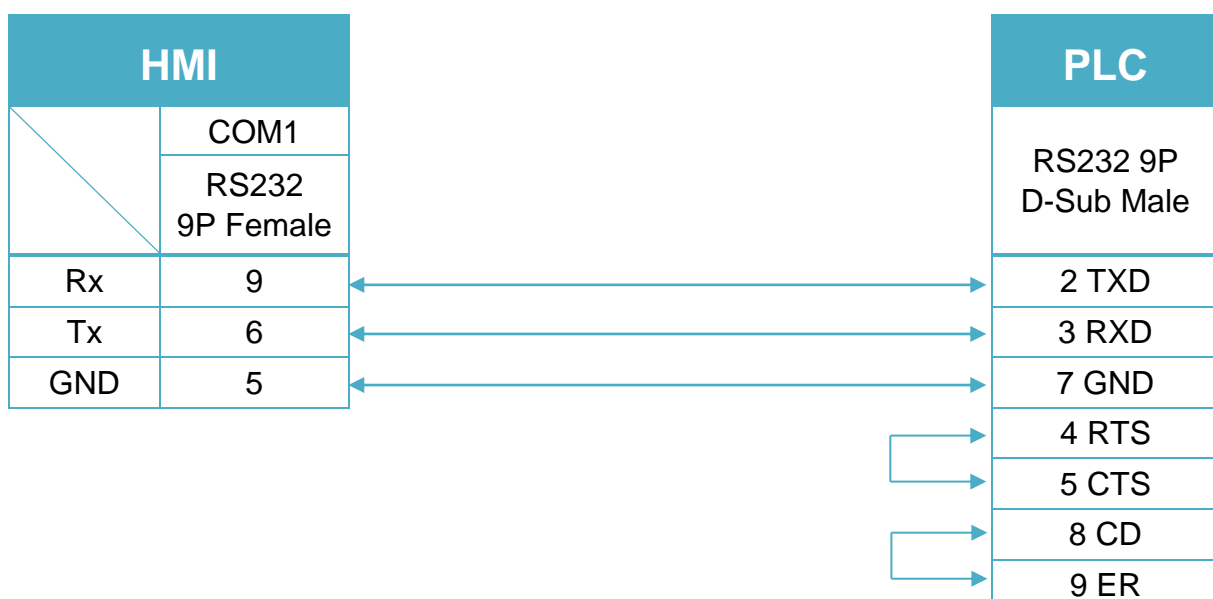


Diagram 9

MT-iE	MT8050iE
MT-iP	MT6051iP / MT6071iP / MT8071iP



The following is the view from the soldering point of a cable.

FP1 CPU : 9P D-Sub to 8P MiniDIN (Diagram 10 ~ Diagram 13)



Diagram 10

cMT Series	<i>cMT3151</i>
eMT Series	<i>eMT3070 / eMT3105 / eMT3120 / eMT3150</i>
MT-iE	<i>MT8070iE / MT6070iE / MT8100iE / MT8121iE / MT8150iE</i>
MT-XE	<i>MT8121XE / MT8150XE</i>

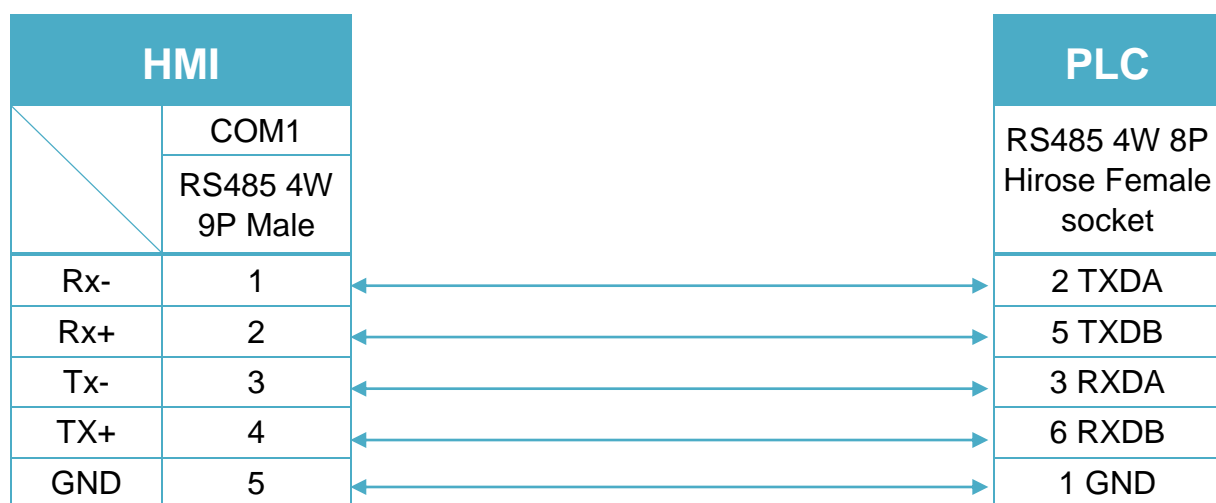


Diagram 11

cMT Series	<i>cMT-SVR</i>
mTV	<i>mTV</i>

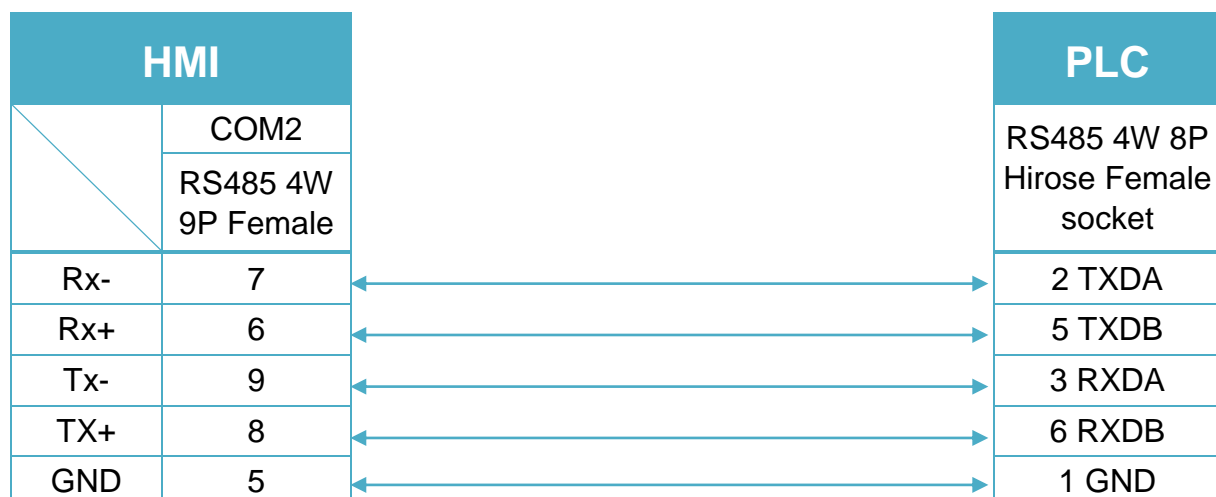


Diagram 12

MT-iE	<i>MT8071iE / MT6071iE / MT8072iE / MT6072iE / MT8073iE / MT8101iE / MT8102iE / MT8103iE</i>
MT-XE	<i>MT8090XE / MT8092XE</i>
MT-iP	<i>MT6071iP / MT8071iP / MT6103iP</i>

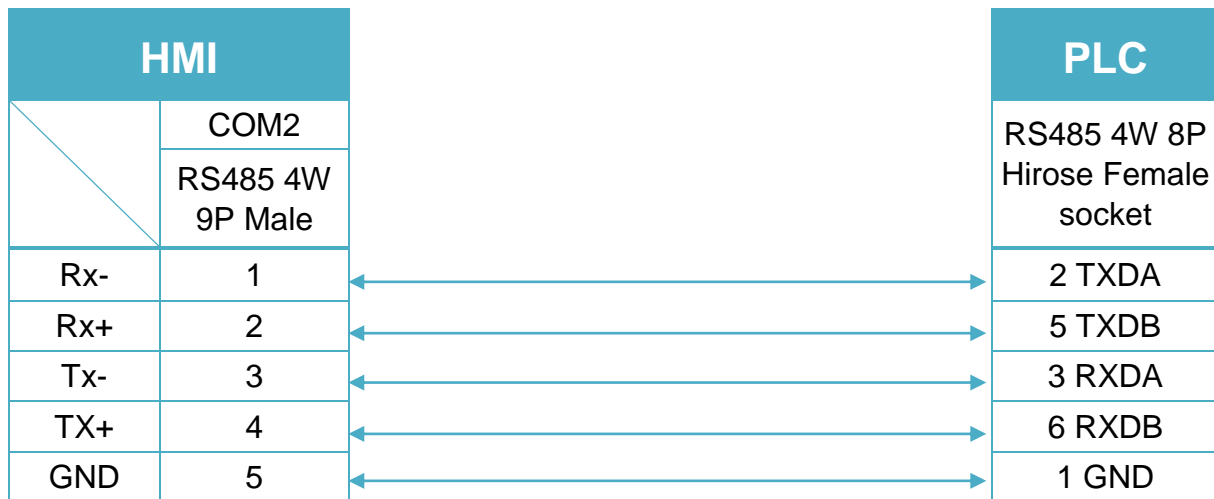
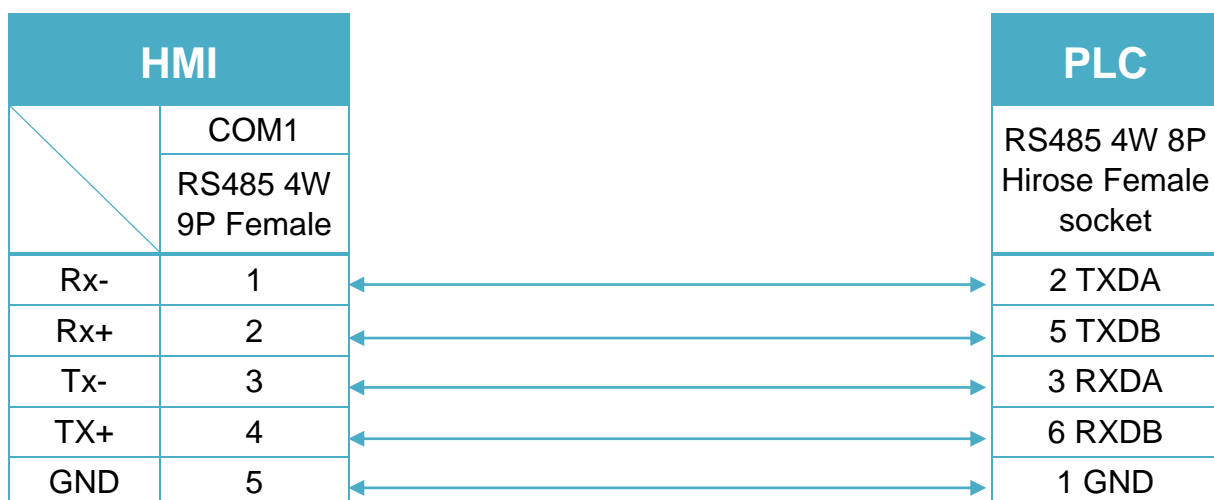


Diagram 13

MT-iE	<i>MT8050iE</i>
MT-iP	<i>MT6051iP</i>



FP3 CPU : 9P D-Sub to 15P D-Sub (Diagram 14 ~ Diagram 17)

Diagram 14

cMT Series	<i>cMT3151</i>
eMT Series	<i>eMT3070 / eMT3105 / eMT3120 / eMT3150</i>
MT-iE	<i>MT8070iE / MT6070iE / MT8100iE / MT8121iE / MT8150iE</i>
MT-XE	<i>MT8121XE / MT8150XE</i>

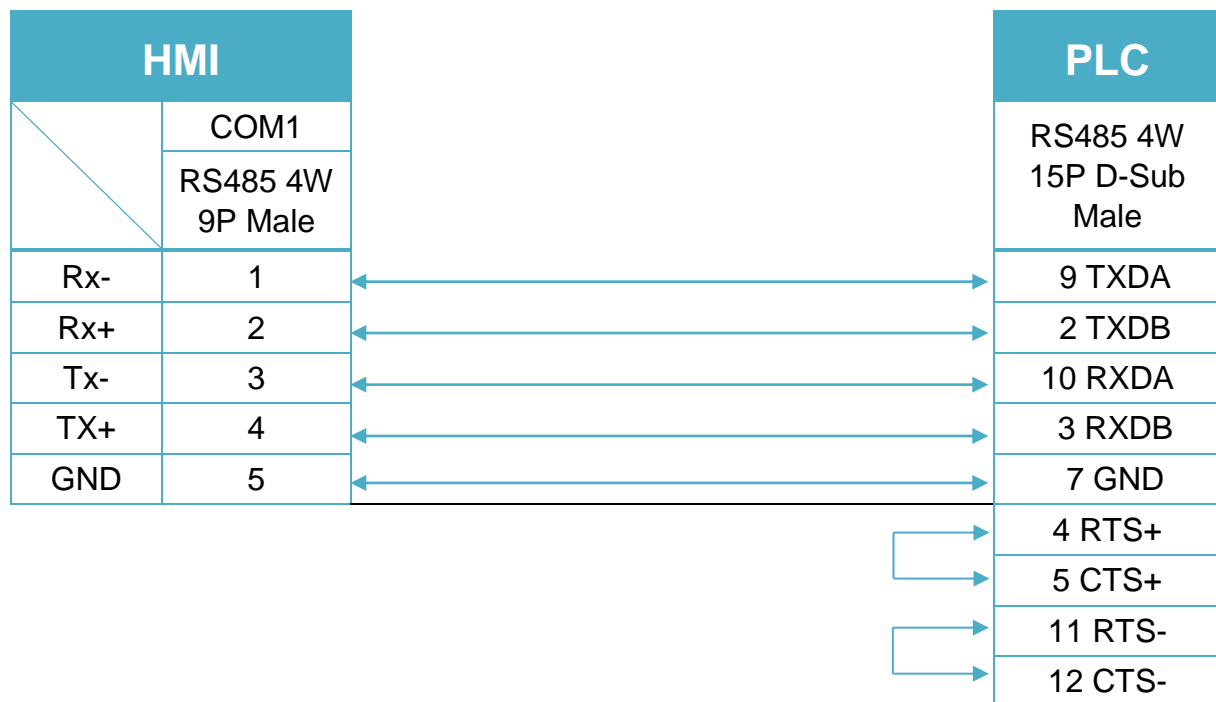
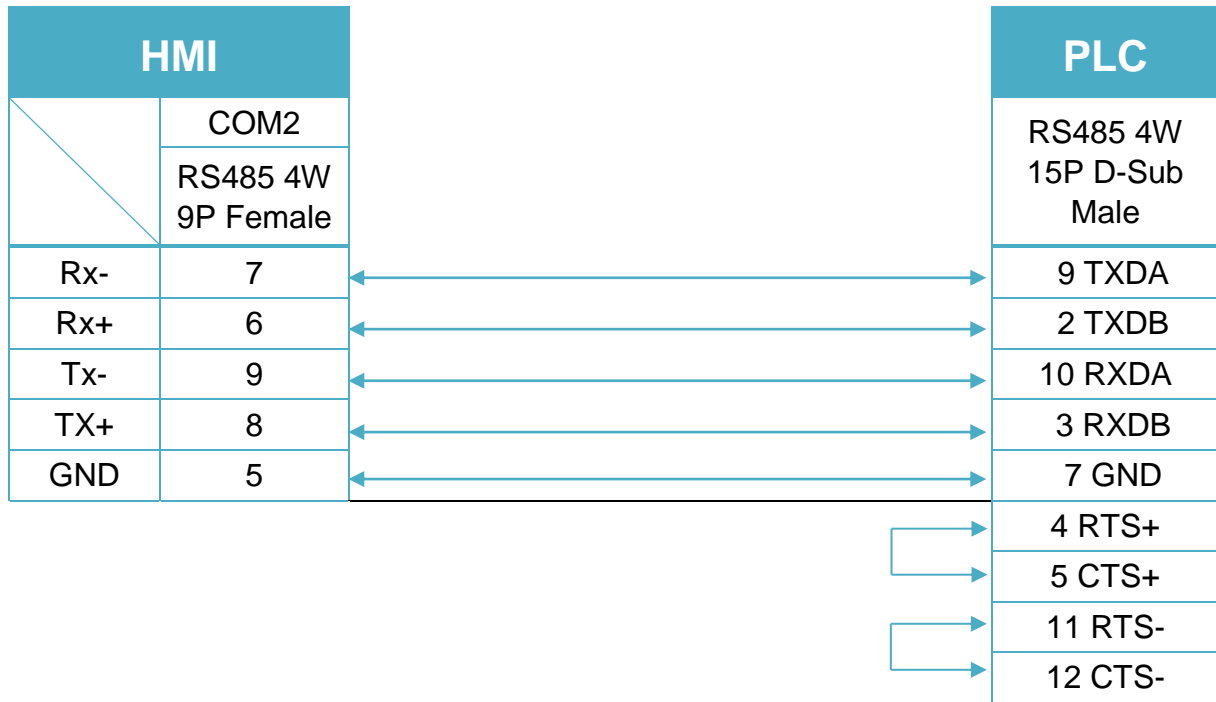


Diagram 15

cMT Series	<i>cMT-SVR</i>
mTV	<i>mTV</i>


Diagram 16

MT-iE	<i>MT8071iE / MT6071iE / MT8072iE / MT6072iE / MT8073iE / MT8101iE / MT8102iE / MT8103iE</i>
MT-XE	<i>MT8090XE / MT8092XE</i>
MT-iP	<i>MT6071iP / MT8071iP / MT6103iP</i>

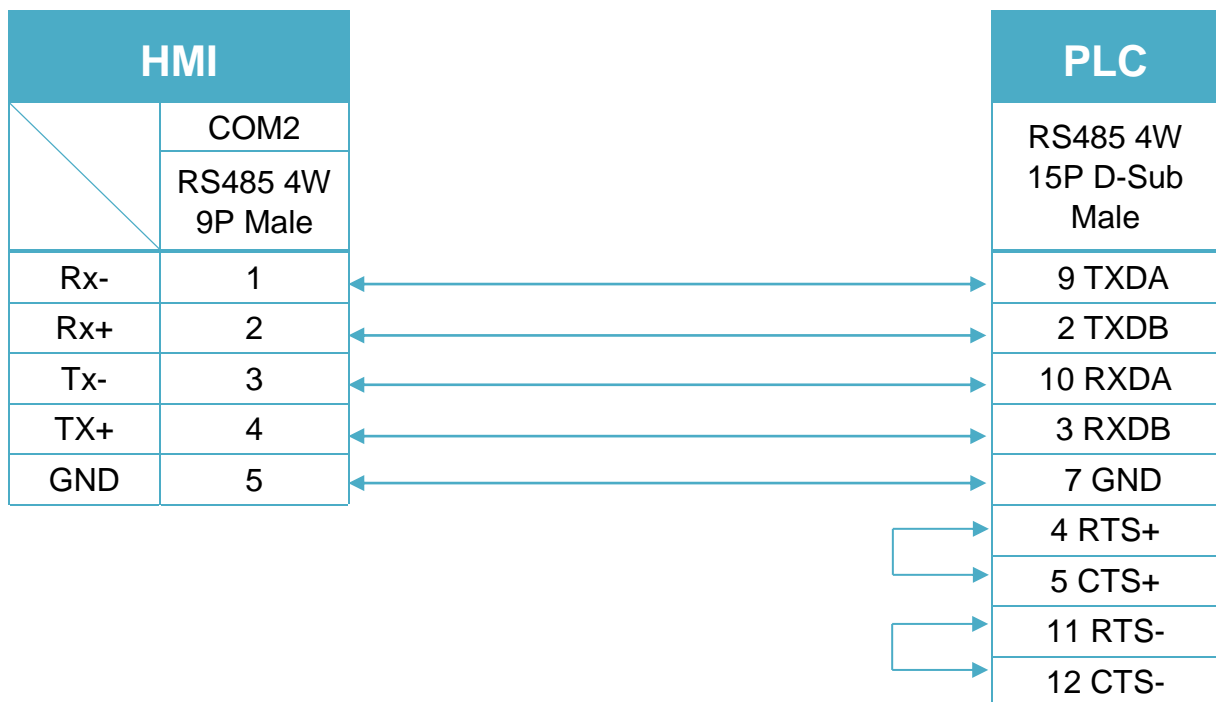
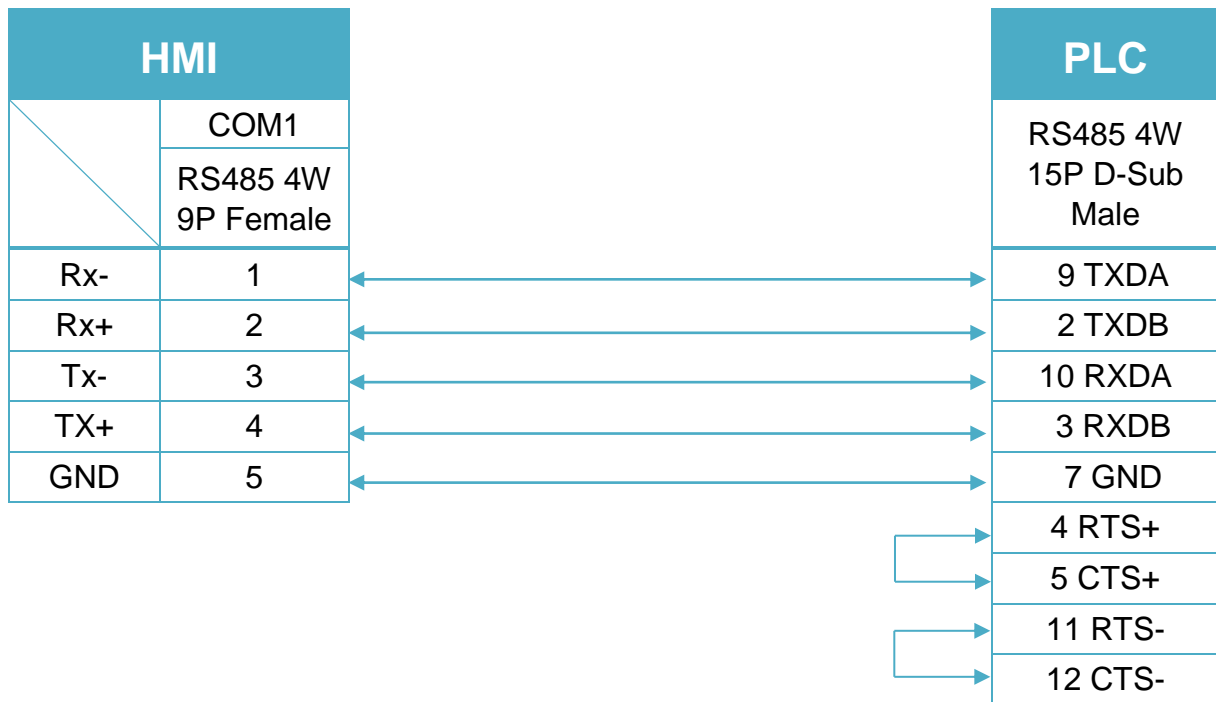


Diagram 17
MT-iE *MT8050iE*
MT-iP *MT6051iP*


Panasonic FP (Ethernet)

Supported Series: FP-X with AFPX-COM5.

Website: <http://pewa.panasonic.com/>

HMI Setting:

Parameters	Recommended	Options	Notes
PLC type	Panasonic FP (Ethernet)		
PLC I/F	Ethernet		
Port no.	9094		
PLC sta. no.	1	0~255	

Device Address:

Bit/Word	Device	Format	Range	Memo
B	X	DDDDh	0 ~ 9999f	Input (X)
B	Y	DDDDh	0 ~ 9999f	Output (Y)
B	R	DDDDh	0 ~ 9999f	Internal Relay (R)
B	L	DDDD	0 ~ 9999	Link Relay (L)
B	L_Bit	DDDDh	0 ~ 9999f	
B	T	DDDD	0 ~ 9999	Timer (T)
B	C	DDDD	0 ~ 9999	Counter (C)
W	SV	DDDD	0 ~ 9999	Timer/Counter Set Value (SV)
W	EV	DDDDD	0 ~ 65535	Timer/Counter Elapse Value (EV)
W	DT	DDDDDD	0 ~ 262143	Data Register (DT)
W	LD	DDDD	0 ~ 8447	Link Register (LD)
W	WX	DDDD	0 ~ 9999	Input (WX) (read only)
W	WY	DDDD	0 ~ 9999	Output (WY)
W	WR	DDDD	0 ~ 9999	Internal Relay (WR)
W	WL	DDDD	0 ~ 9999	Link Relay (WL)
W	FL	DDDDD	0 ~ 99999	File Register (FL)

Wiring Diagram:

Ethernet cable:



Ethernet Connection TCP Port: 9094



Panasonic FP2 (Ethernet)

Supported Series: NAIS (Matsushita) FP2 series include FP2, FP2SH, and FP10SH CPU.

Website: <http://pewa.panasonic.com/>

HMI Setting:

Parameters	Recommended	Options	Notes
PLC type	Panasonic FP2 (Ethernet)		
PLC I/F	Ethernet		
Port no.	8500		
PLC sta. no.	2	0~255	

Device Address:

Bit/Word	Device type	Format	Range	Memo
B	X	DDDDh	0 ~ 9999f	Input (X)
B	Y	DDDDh	0 ~ 9999f	Output (Y)
B	R	DDDDh	0 ~ 9999f	Internal Relay (R)
B	L	DDDD	0 ~ 9999	Link Relay (L)
B	L_Bit	DDDDh	0 ~ 9999f	
B	T	DDDD	0 ~ 9999	Timer (T)
B	C	DDDD	0 ~ 9999	Counter (C)
W	SV	DDDD	0 ~ 9999	Timer/Counter Set Value (SV)
W	EV	DDDDD	0 ~ 65535	Timer/Counter Elapse Value (EV)
W	DT	DDDDD	0 ~ 99999	Data Register (DT)
W	LD	DDDD	0 ~ 8447	Link Register (LD)
W	WX	DDDD	0 ~ 9999	Input (WX) (read only)
W	WY	DDDD	0 ~ 9999	Output (WY)
W	WR	DDDD	0 ~ 9999	Internal Relay (WR)
W	WL	DDDD	0 ~ 9999	Link Relay (WL)

Wiring Diagram:

Ethernet cable:



Panasonic MEWTOCOL7

Supported Series: Panasonic GT series FP7

Website: <http://pewa.panasonic.com/>

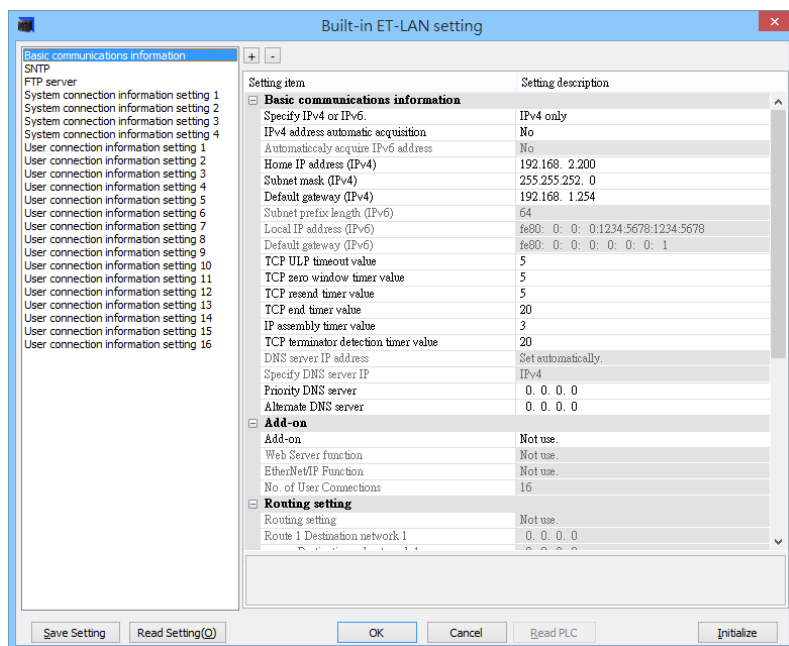
HMI Setting:

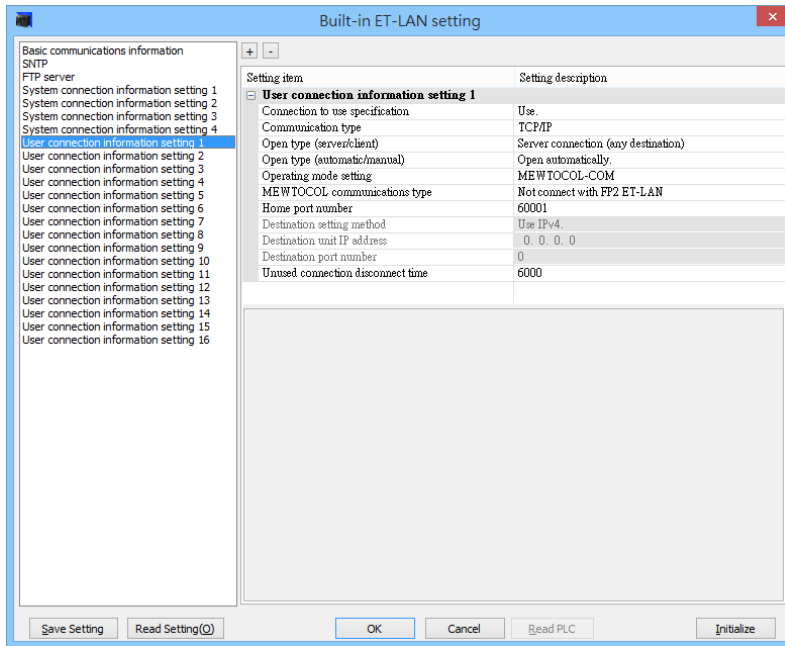
Parameters	Recommended	Options	Notes
PLC type	Panasonic MEWTOCOL7		
PLC I/F	RS232 / Ethernet		
Baud rate	9600	9600 ~ 115200	
Data bits	8	7,8	
Parity	Odd	Even, None, Odd	
Stop bits	1	1,2	
PLC sta. no.	1	1 ~ 256	
Port no.	60001	1 ~ 65535	

PLC Setting:

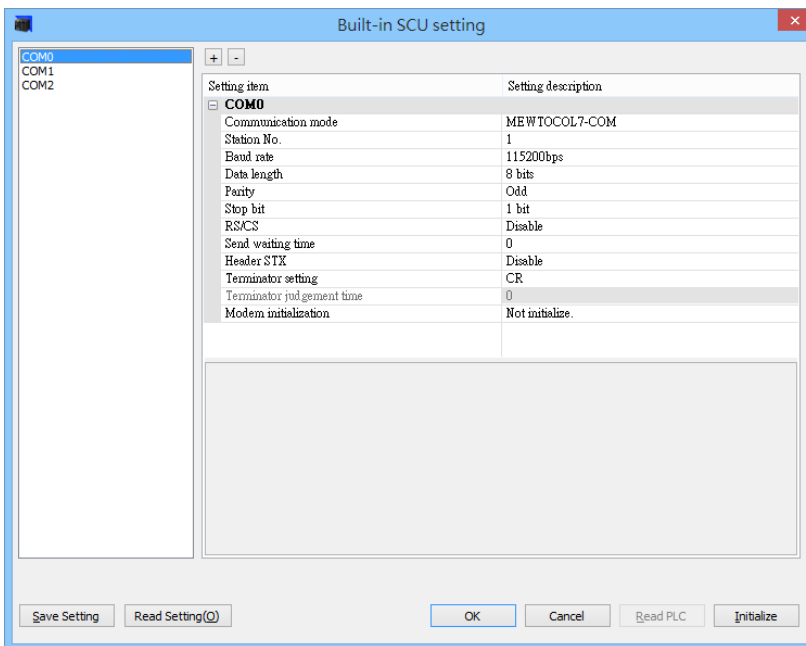
Communication type	TCP/IP
Open type	Server connection (any destination)
Communication mode	MEWTOCOL7-COM

Built-in ET-LAN setting





Built-in SCU setting



Device Address:

Bit/Word	Device type	Format	Range	Memo
B	X	DDDh	0 ~ 511f	External input
B	Y	DDDh	0 ~ 511f	External output
B	R	DDDDh	0 ~ 2047f	Internal relay
B	L	DDDDh	0 ~ 1023f	Link relay
B	T	DDDD	0 ~ 4095	Timer
B	C	DDDD	0 ~ 1023	Counter
B	P	DDDh	0 ~ 255f	Pulse relay
B	E	DDDD	0 ~ 4095	Error notification relay
B	SR	DDDh	0 ~ 223f	System relay
B	IN	SSDDh	1000 ~ 9962f	Direct input *note1
B	OT	SSDDh	1000 ~ 9962f	Direct output *note1
B	LD_Bit	DDDDD.h	0 ~ 16383.f	LD bit specification
B	DT_Bit	DDDDDD.h	0 ~ 999423.f	DT bit specification
B	UM_Bit	SSHHHHH.h	0 ~ 997FFFF.f	UM bit specification *note1
B	_X	LLLDDDDh	10000 ~ 999511f	External input *note2
B	_Y	LLLDDDDh	10000 ~ 999511f	External output *note2
B	_R	LLLDDDDh	100000 ~ 9992047f	Internal relay *note2
B	_L	LLLDDDDh	100000 ~ 9991023f	Link relay *note2
B	_T	LLLDDDD	10000 ~ 9994095	Timer *note2
B	_C	LLLDDDD	10000 ~ 9991023	Counter *note2
B	_P	LLLDDDDh	10000 ~ 999255f	Pulse relay *note2
B	_LD_Bit	LLLDDDDD.h	100000.0 ~ 9991633.f	LD bit specification *note2
B	_DT_Bit	LLLDDDDDD.h	1000000.0 ~ 999999423.f	DT bit specification *note2
W	WX	DDD	0 ~ 511	External input word
W	WY	DDD	0 ~ 511	External output word
W	WR	DDDD	0 ~ 2047	Internal relay word
W	WL	DDDD	0 ~ 1023	Link relay word
W	WS	DDD	0 ~ 223	System relay word
W	LD	DDDDD	0 ~ 16383	Link register
W	DT	DDDDDD	0 ~ 999423	Data register
W	SD	DDD	0 ~ 255	System register
W	WI	SSDD	100 ~ 9962	Input register *note1
W	WO	SSDD	100 ~ 9962	Output register *note1
W	UM	SSHHHHH	100000 ~ 997FFFF	Unit memory *note1
DW	TS	DDDD	0 ~ 4095	Timer setting value

Bit/Word	Device type	Format	Range	Memo
DW	TE	DDDD	0 ~ 4095	Timer elapsed value
DW	CS	DDDD	0 ~ 1023	Counter setting value
DW	CE	DDDD	0 ~ 1023	Counter elapsed value
DW	I	H	0 ~ E	Index register
W	_WX	LLLDDDD	1000 ~ 999511	External input word *note2
W	_WY	LLLDDDD	1000 ~ 999511	External output word *note2
W	_WR	LLLDDDD	10000 ~ 9992047	Internal relay word *note2
W	_WL	LLLDDDD	10000 ~ 9991023	Link relay word *note2
W	_LD	LLLDDDDDD	100000 ~ 99916383	Link register *note2
W	_DT	LLLDDDDDD	1000000 ~ 999999423	Data register *note2
DW	_TS	LLLDDDD	10000 ~ 9994095	Timer setting value *note2
DW	_TE	LLLDDDD	10000 ~ 9994095	Timer elapsed value *note2
DW	_CS	LLLDDDD	10000 ~ 9991023	Counter setting value *note2
DW	_CE	LLLDDDD	10000 ~ 9991023	Counter elapsed value *note2

*note1: SS = Slot address (1~99)

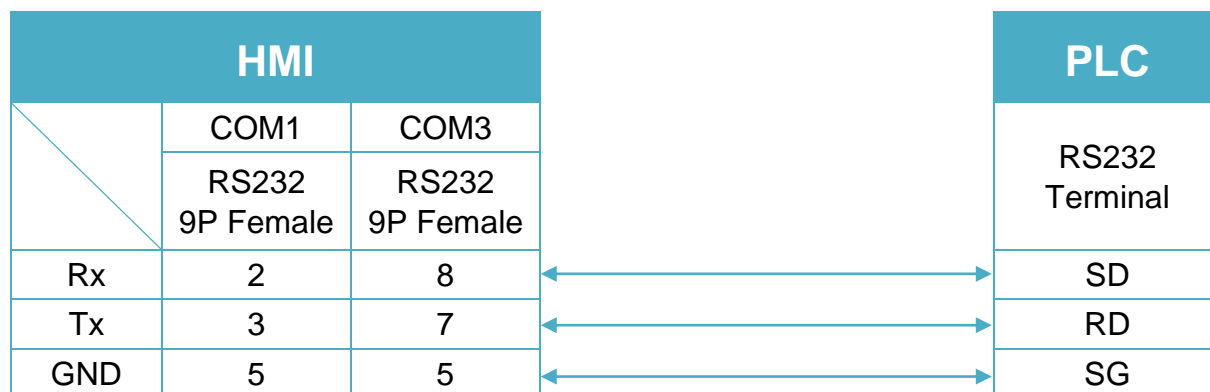
*note2: LLL= Local address (Program block)

Wiring Diagram:

RS-232 terminal (Diagram 1 ~ Diagram 3)

Diagram 1

cMT Series	<i>cMT3151</i>
eMT Series	<i>eMT3070 / eMT3105 / eMT3120 / eMT3150</i>
MT-iE	<i>MT8073iE / MT8102iE</i>
MT-XE	<i>MT8092XE</i>
MT-iP	<i>MT6103iP</i>


Diagram 2

cMT Series	<i>cMT-SVR</i>
mTV	<i>mTV</i>
MT-iE	<i>MT8070iE / MT6070iE / MT8100iE / MT8121iE / MT8150iE / MT8071iE / MT6071iE / MT8072iE / MT6072iE / MT8073iE / MT8101iE / MT8102iE / MT8103iE</i>
MT-XE	<i>MT8121XE / MT8150XE / MT8090XE</i>



Diagram 3

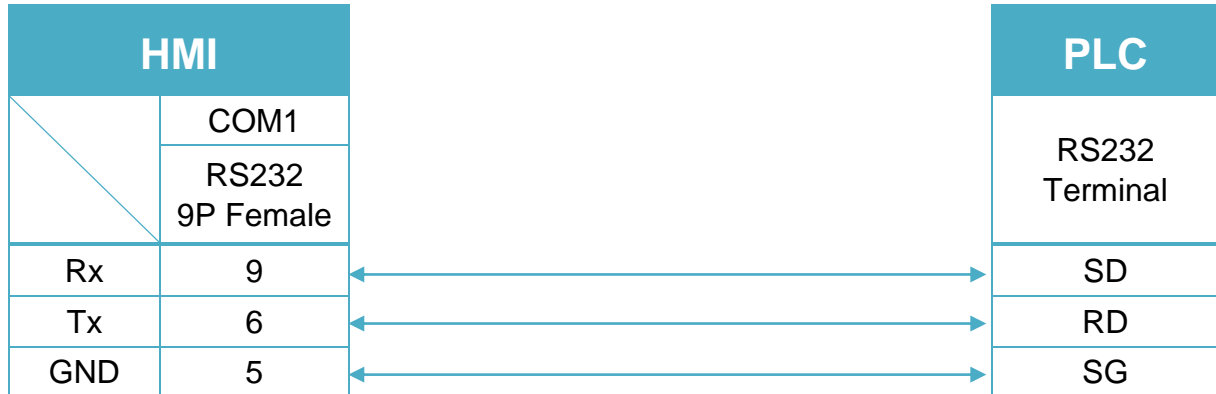
MT-iE
MT8050iE
MT-iP
MT6051iP / MT6071iP / MT8071iP


Diagram 4

Ethernet cable:


Panasonic MINAS A4

Supported Series: Panasonic MINAS A4 series Servo Drive.

HMI Setting:

Parameters	Recommended	Options	Notes
PLC type	Panasonic MINAS A4		
PLC I/F	RS232		
Baud rate	9600	2400 ~ 57600	
Data bits	8		
Parity	None		
Stop bits	1		
Axis no.	0 (master station only)	0 ~ F (slave)	

Device Address:

Bit/Word	Device type	Format	Range	Memo
B	Command 20	D	0 ~ 7	States (Note 3)
B	Command 27	DD	0 ~ 31	Input Signal (Note 3)
B	Command 28	DD	0 ~ 31	Output Signal (Note 3)
W	Command 01	D	0	CPU Version (Numeric format: 16-bit Hex)
W	Command 05	DD	0 ~ 11	Driver Version (ASCII / 12 words)
W	Command 06	DD	0 ~ 11	Motor Version (ASCII / 12 words)
W	Command 21	D	0 ~ 1	command pulse counter (Numeric format: 32-bit Signed)
W	Command 22	D	0 ~ 1	feedback pulse counter (Numeric format: 32-bit Signed)
W	Command 24	D	0	present speed (Numeric format: 16-bit Unsigned)
W	Command 25	D	0	present torque (Numeric format: 16-bit Unsigned)
W	Command 26	D	0 ~ 1	present deviation counter (Numeric format: 32-bit Signed)
W	Command 84	D	0	write parameter to EEPROM (Note 1)
W	Command 90	D	0	present Alarm Data

Bit/Word	Device type	Format	Range	Memo
				(Numeric format: 16-bit Unsigned)
W	Command 91	DD	1 ~ 14	Alarm History (Note 4) (Numeric format: 16-bit Unsigned)
W	Command 92	DD	1 ~ 14	Batch Alarm (Note 4) (Numeric format: 16-bit Unsigned)
W	Command 93	D	0	clear Alarm History (include EEPROM) (Note 1)
W	Command 94	D	0	Alarm Clear (Note 1)
W	Command 9B	D	0	Absolute Clear (Note 1)
W	Parameter	HH	0 ~ 7f	Individual Parameter (range: 0x00 ~ 0x7F) (Note 2)
W	Comm2D_S	D	0 ~ 1	Command 2D Single turn data (Numeric format: 32-bit Signed)
W	Comm2D_M	D	0 ~ 1	Command 2D Multi-turn data (Numeric format: 32-bit Signed)

Note:

- Command 84, Command 93, Command 94, and Command 9B are write only. (These commands are able to use Set Bit Object and execute the write command after triggering Set Bit Object.). Commands other than these four are read only.
- Parameter read/write: Use device type to define address control from 00~7F.
For example: "address_00" is mapping to "Parameter_00".
(Please refer to Panasonic MINAS A4 Series User Manual.)
- Device address type can define MINAS A4 Driver's command list.
Command 20, Command 27, and Command 28 are Bit type, use "Operating range" to map communication order status.
For example: "Command 20_3" means "Read state_CCW".
(Please refer to Panasonic MINAS A4 Series User Manual.)
- Command 91 and Command 92 are word type, use "Operating range" to map the record of 14 alarms.
For example: "Command 91_1" means "Read alarm data_First alarm".

Wiring Diagram:

The following is the view from the soldering point of a cable.

MINAS A4 Driver CNX4 Port



Diagram 1

cMT Series	<i>cMT3151</i>
eMT Series	<i>eMT3070 / eMT3105 / eMT3120 / eMT3150</i>
MT-iE	<i>MT8073iE / MT8102iE</i>
MT-XE	<i>MT8092XE</i>
MT-iP	<i>MT6103iP</i>

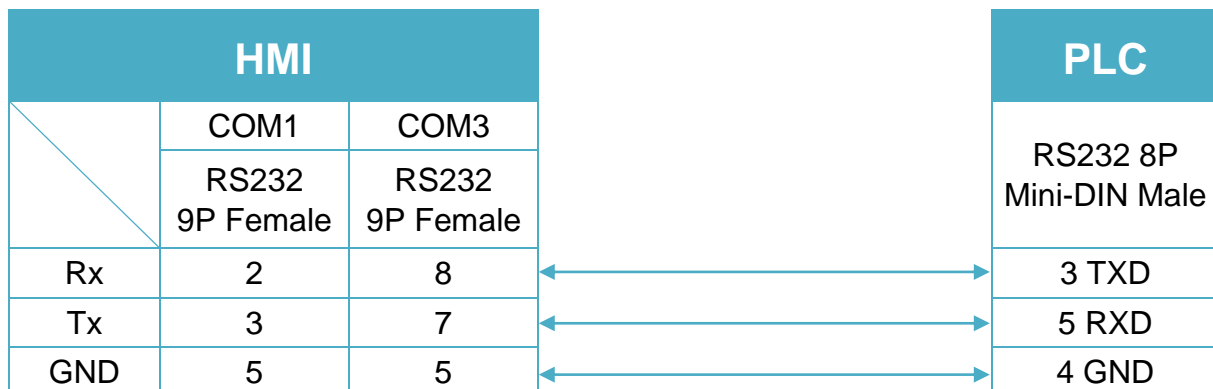


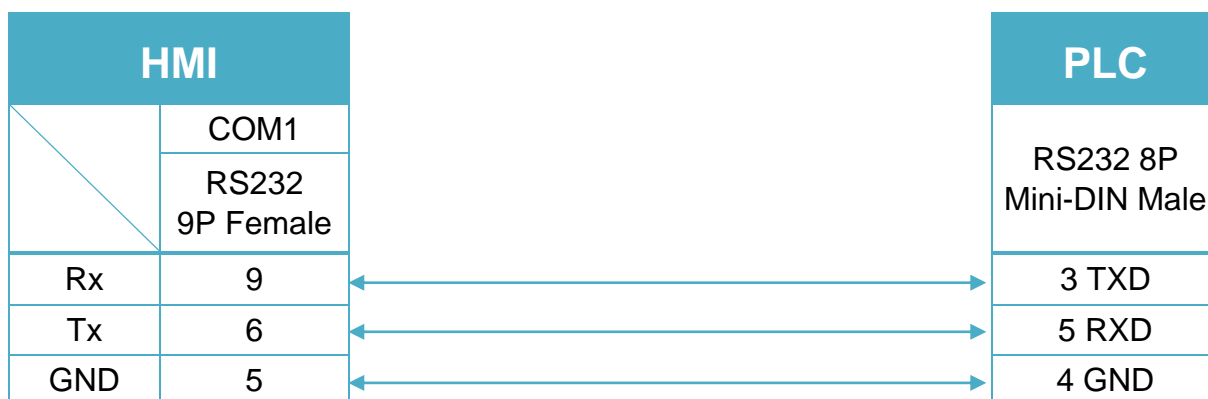
Diagram 2


cMT Series	cMT-SVR
mTV	mTV
MT-iE	MT8070iE / MT6070iE / MT8100iE / MT8121iE / MT8150iE / MT8071iE / MT6071iE / MT8072iE / MT6072iE / MT8073iE / MT8101iE / MT8102iE / MT8103iE
MT-XE	MT8121XE / MT8150XE / MT8090XE



Diagram 3

MT-iE	MT8050iE
MT-iP	MT6051iP / MT6071iP / MT8071iP



 <p>8P Mini-Din Male MINAS A4 Driver CNX3 / CNX4 Port</p>	MINAS A4 Driver CNX3 Port	MINAS A4 Driver CNX4 Port
		3 TX
		5 RX
	4 GND	4 GND
	7 D-	7 D-
	8 D+	8 D+

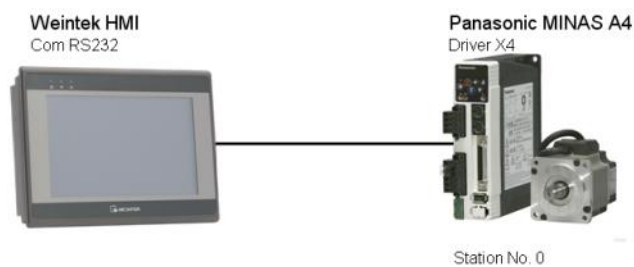
RS485 cable / DVOP1970-005

MINAS A4 Driver 8p Mini-DIN Male		MINAS A4 Driver 8p Mini-DIN Male
7 D-		7 D-
8 D+		8 D+
4 GND		4 GND

RS232 cable / DVOP1960

MINAS A4 Driver 9P D-SUB Female		MINAS A4 Driver 8p Mini-DIN Male
3 RXD		5 RXD
2 TXD		3 TXD
5 GND		4 GND

HMI connect with one Device



HMI connect with multi devices



Panasonic MINAS A5

Supported Series: Panasonic MINAS A5 series Servo Drive.

HMI Setting:

Parameters	Recommended	Options	Notes
PLC type	Panasonic MINAS A5		
PLC I/F	RS232	RS232/RS485 2W	
Baud rate	9600	2400~115200	
Data bits	8		
Parity	None		
Stop bits	1		
Axis no.	0 (master station only)	0 ~ 127 (slave)	

* When connecting with more than two devices, it is recommended to set timeout to more than 4 seconds. Set a longer timeout when connecting with more devices to maintain good communication.

Device Address:

Bit/Word	Device type	Format	Range	Memo
B	Command 20	D	0 ~ 7	States (Note 3)
B	Command 27	DD	0 ~ 31	Input Signal (Note 3)
B	Command 28	DD	0 ~ 31	Output Signal (Note 3)
W	Command 01	D	0	CPU Version (Numeric format:16-bit Hex)
W	Command 05	DD	0 ~ 11	Driver Version (ASCII / 12 words)
W	Command 06	DD	0 ~ 11	Motor Version (ASCII / 12 words)
W	Command 21	D	0 ~ 1	command pulse counter (Numeric format: 32-bit Signed)
W	Command 22	D	0 ~ 1	feedback pulse counter (Numeric format: 32-bit Signed)
W	Command 24	D	0	present speed (Numeric format: 16-bit Unsigned)
W	Command 25	D	0	present torque (Numeric format: 16-bit Unsigned)
W	Command 26	D	0 ~ 1	present deviation counter (Numeric format: 32-bit Signed)

Bit/Word	Device type	Format	Range	Memo
W	Command2D_S	D	0 ~ 1	Command 2D Single turn data (Numeric format: 32-bit Signed)
W	Command2D_M	D	0 ~ 1	Command 2D Multi-turn data (Numeric format: 32-bit Signed)
W	Parameter	HHH	0 ~ 639	Individual Parameter (range: 0x000 ~ 0x639) (Note 2)
W	Command 72	D	0	write parameter to EEPROM (Note 1)
W	Command 90	D	0	present Alarm Data (Numeric format: 16-bit Unsigned)
W	Command 92	DD	1 ~ 14	Batch Alarm (Note 4) (Numeric format: 16-bit Unsigned)
W	Command 93	D	0	clear Alarm History (include EEPROM) (Note 1)
W	Command 94	D	0	Alarm Clear (Note 1)
W	Command 9B	D	0	Absolute Clear (Note 1)

Note:

1. Command 72, Command 93, Command 94, and Command 9B are write only. (These commands are able to use Set Bit Object and execute the write command after triggering Set Bit Object.). Commands other than these four are read only.
2. Parameter read/write: Use device type to define address control from 000~639. For example: "address_000" is mapping to "Parameter_000". (Please refer to Panasonic MINAS A5 Series User Manual.)
3. Device address type can define MINAS A5 Driver's command list. Command 20, Command 27, and Command 28 are Bit type, use "Operating range" to map communication order status. For example: "Command 20_3" means "Read state_CCW". (Please refer to Panasonic MINAS A5 Series User Manual.)
4. Command 92 are word type, use "Operating range" to map the record of 14 alarms.

Wiring Diagram:

The following is the view from the soldering point of a cable.

MINAS A5 Driver X2 Port RS232 Signal (Diagram 1 ~ Diagram 3)

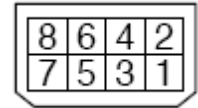


Diagram 1

cMT Series	cMT3151
eMT Series	eMT3070 / eMT3105 / eMT3120 / eMT3150
MT-iE	MT8073iE / MT8102iE
MT-XE	MT8092XE
MT-iP	MT6103iP

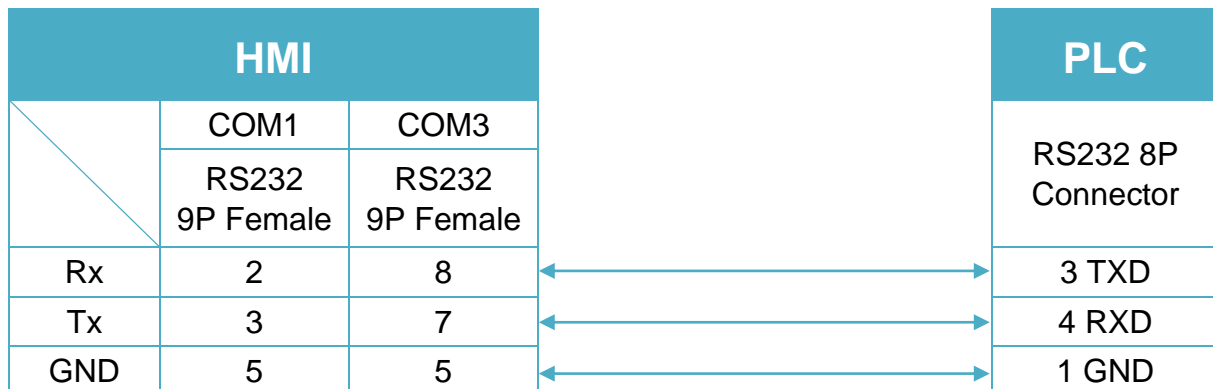


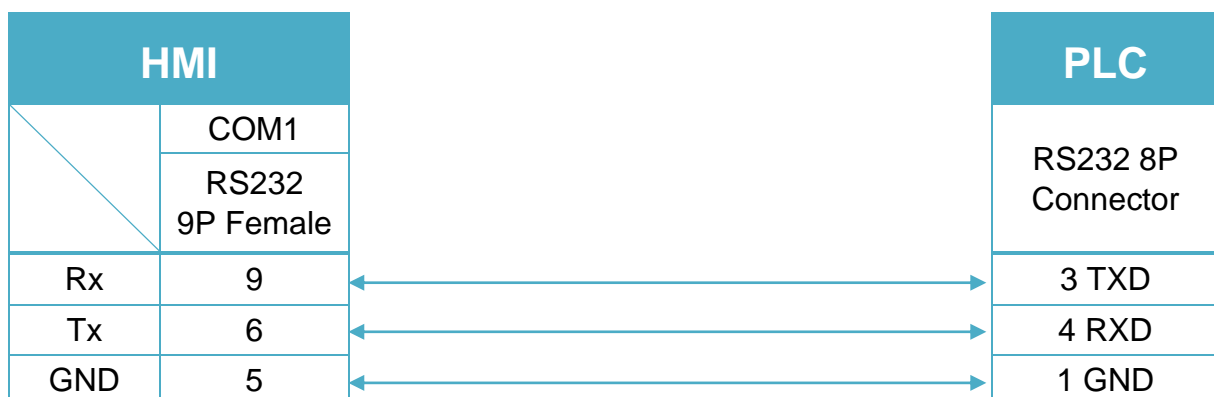
Diagram 2

cMT Series	cMT-SVR
mTV	mTV
MT-iE	MT8070iE / MT6070iE / MT8100iE / MT8121iE / MT8150iE / MT8071iE / MT6071iE / MT8072iE / MT6072iE / MT8073iE / MT8101iE / MT8102iE / MT8103iE
MT-XE	MT8121XE / MT8150XE / MT8090XE



Diagram 3

MT-iE	MT8050iE
MT-iP	MT6051iP / MT6071iP / MT8071iP



The following is the view from the soldering point of a cable.

MINAS A5 Driver X2 Port RS485 Signal (Diagram 4 ~ Diagram 9)

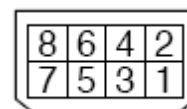


Diagram 4

cMT Series

cMT3151

eMT Series

eMT3070 / eMT3105 / eMT3120 / eMT3150

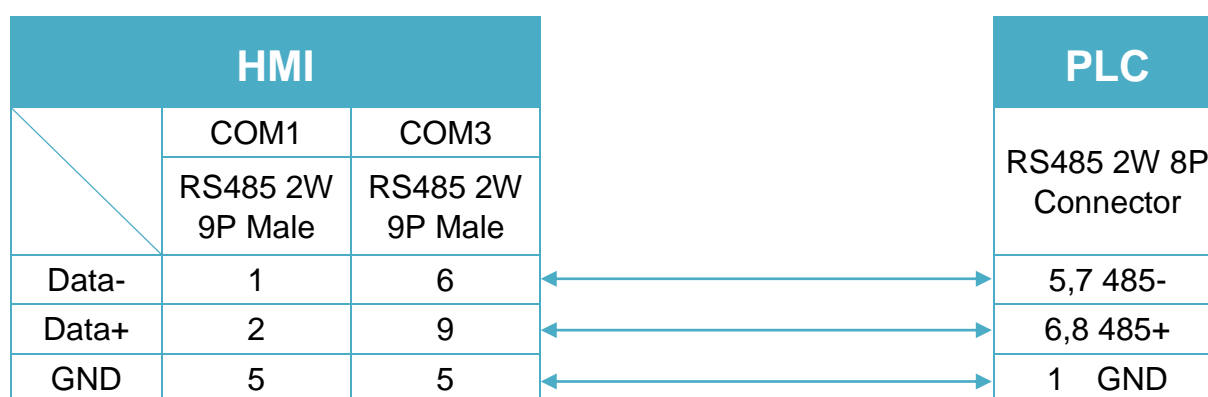


Diagram 5

cMT Series

cMT-SVR

mTV

mTV

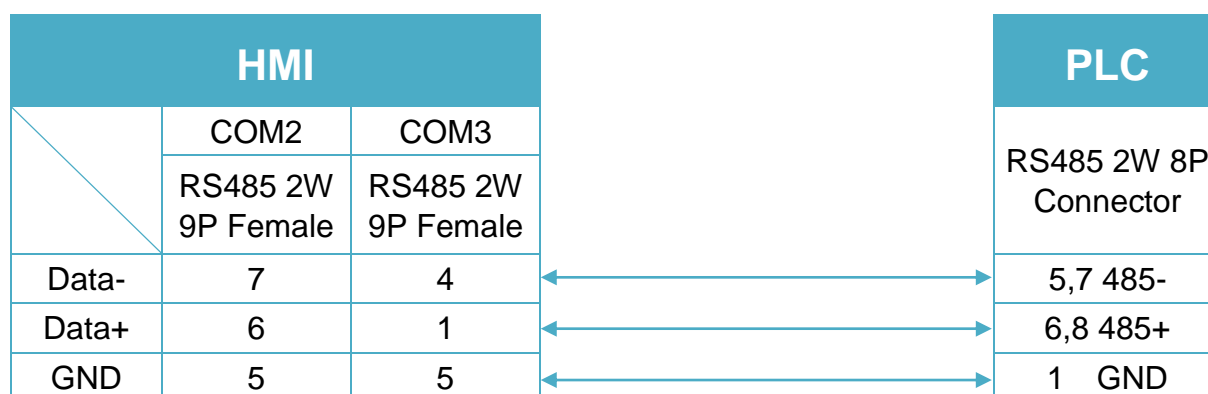


Diagram 6

MT-iE *MT8070iE / MT6070iE / MT8100iE / MT8121iE / MT8150iE*

MT-XE *MT8121XE / MT8150XE*

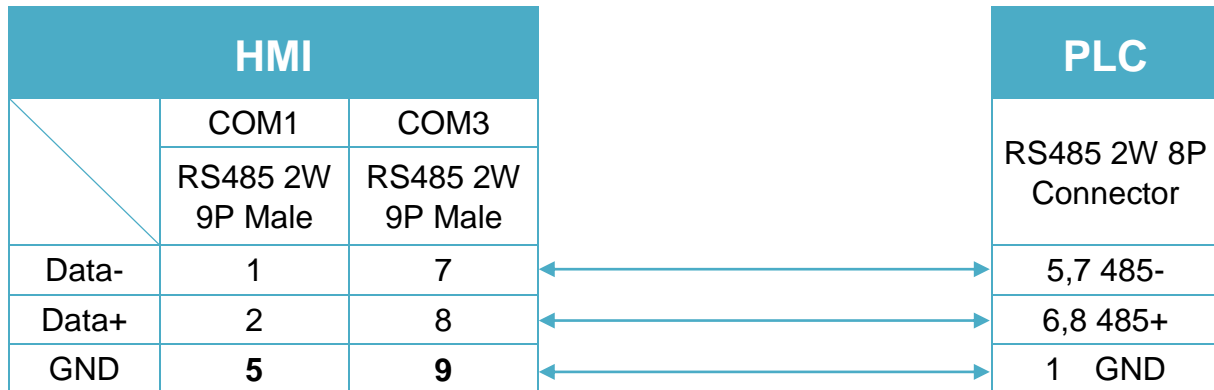


Diagram 7

MT-iE *MT8071iE / MT6071iE / MT8072iE / MT6072iE / MT8073iE / MT8101iE / MT8102iE / MT8103iE*

MT-XE *MT8090XE / MT8092XE*

MT-iP *MT6103iP*

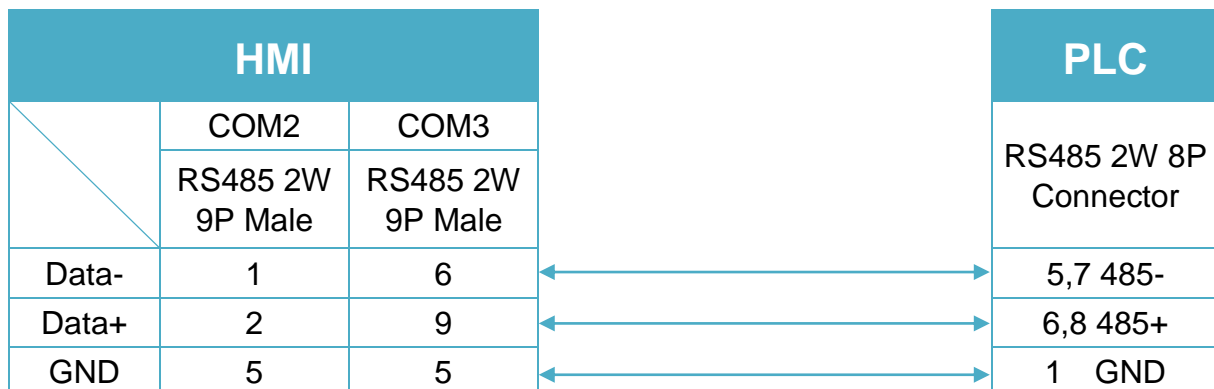
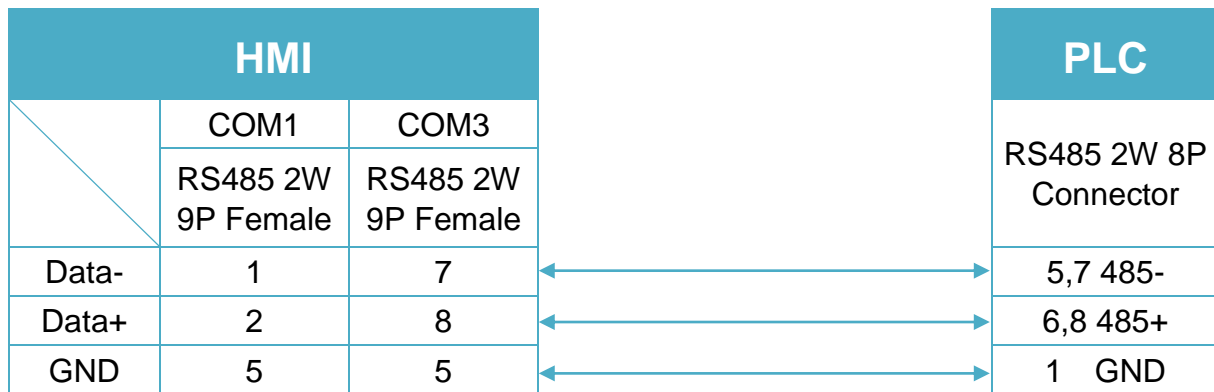


Diagram 8
MT-iE *MT8050iE*
MT-iP *MT6051iP*

Diagram 9
MT-iP *MT6071iP / MT8071iP*


Parker ACR9000

Supported Series: Parker ACR9000.

Website: <http://www.parkermotion.com>

HMI Setting:

Parameters	Recommended	Options	Notes
PLC type	Parker ACR9000		
PLC I/F	RS232	RS485 4W / RS232/Ethernet	
Baud rate	38400	1200 - 38400	
Data bits	8	7,8	
Parity	None	Even, Odd, None	
Stop bits	1	1,2	
Port no.	5006		
PLC sta. no.	0		

Online simulator	YES
------------------	-----

Device Address:

Bit/Word	Device type	Format	Range	Memo
B	P_Low16bit	DDDDDDdd	0 ~ 9999915	
B	P_High16bit	DDDDDDdd	0 ~ 9999915	
W	P_Int32	DDDDD	0 ~ 99999	
W	P_Float	DDDDD	0 ~ 99999	

Wiring Diagram:

RS-232 9P D-Sub (Diagram 1 ~ Diagram 3)

Diagram 1

cMT Series	<i>cMT3151</i>
eMT Series	<i>eMT3070 / eMT3105 / eMT3120 / eMT3150</i>
MT-iE	<i>MT8073iE / MT8102iE</i>
MT-XE	<i>MT8092XE</i>
MT-iP	<i>MT6103iP</i>

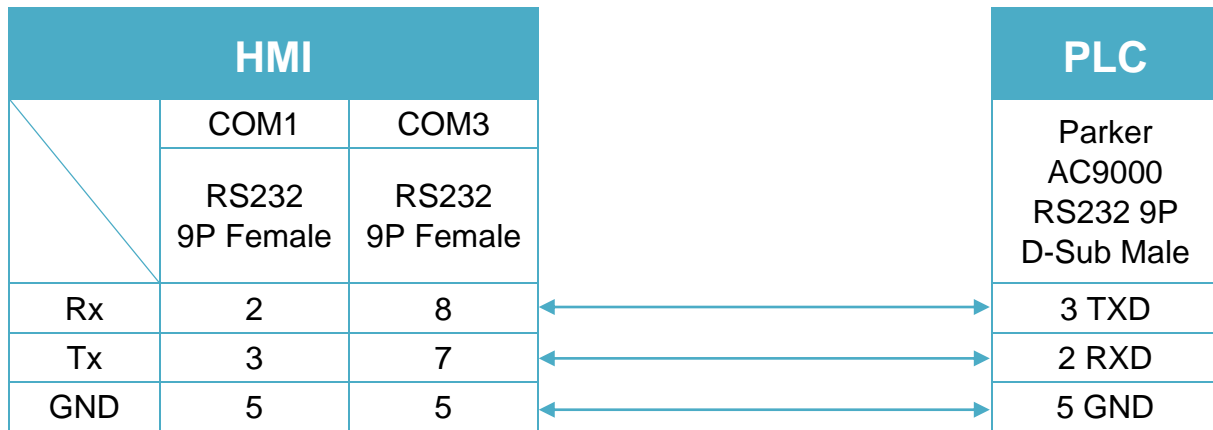
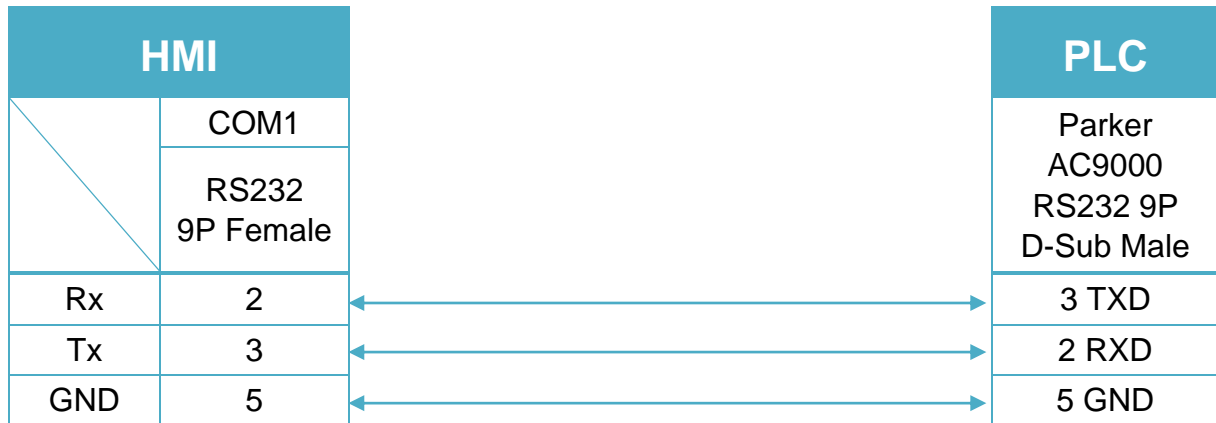
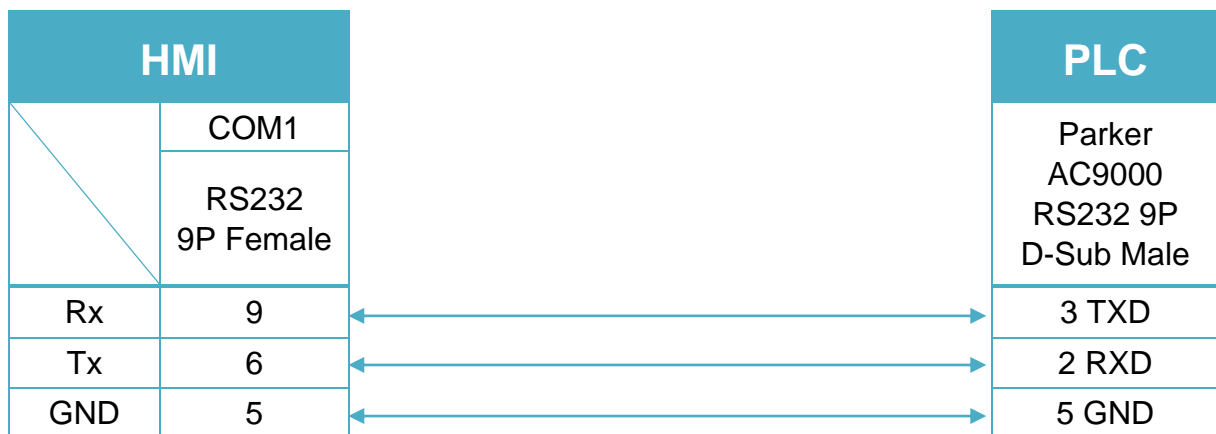
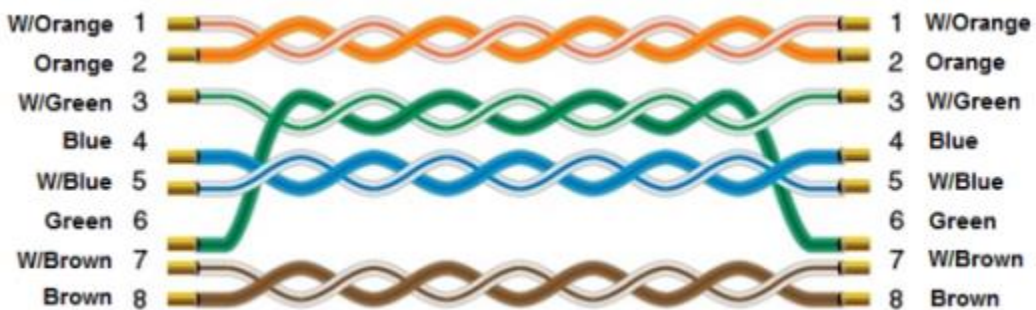


Diagram 2

cMT Series	<i>cMT-SVR</i>
mTV	<i>mTV</i>
MT-iE	<i>MT8070iE / MT6070iE / MT8100iE / MT8121iE / MT8150iE / MT8071iE / MT6071iE / MT8072iE / MT6072iE / MT8073iE / MT8101iE / MT8102iE / MT8103iE</i>
MT-XE	<i>MT8121XE / MT8150XE / MT8090XE</i>


Diagram 3
MT-iE
MT8050iE
MT-iP
MT6051iP / MT6071iP / MT8071iP

Diagram 4
Ethernet cable:


Parker Compax3

Supported Series: Parker Compax3 Servo Drive.

Website: <http://www.parker.com>

HMI Setting:

RS232

Parameters	Recommended	Options	Notes
PLC type	Parker Compax3		
PLC I/F	RS232		
Baud rate	115200		
Data bits	8	7 or 8	
Parity	None	Even, Odd, None	
Stop bits	1	1 or 2	
PLC sta. no.	0	0	Must be 0 for RS232

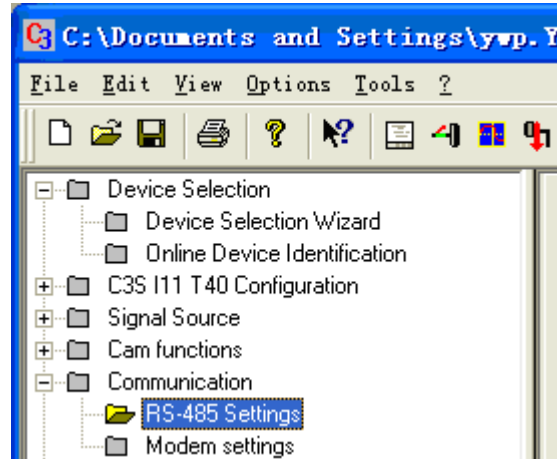
RS485

Parameters	Recommended	Options	Notes
PLC type	Parker Compax3		
PLC I/F	RS485 2W		
Baud rate	9600		
Data bits	8	7 or 8	
Parity	None	Even, Odd, None	
Stop bits	1	1 or 2	
PLC sta. no.	1	1-99	Range from 1 to 99 for RS485, according to the PLC setting.

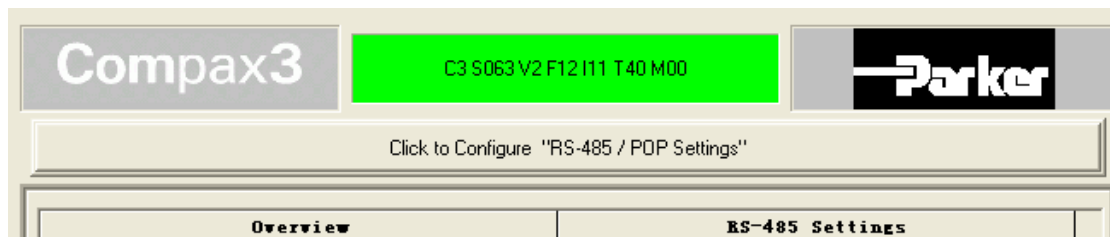
PLC Setting:

How to set Compax 3 servo to RS485 mode?

1. Open C3 ServoManager2, select "Communication" => "RS-485 Settings".



2. Click to Configure "RS-485/POP Settings".



3. Set parameters as below:

The diagram shows a servo motor's communication interface with TxD, RE, and RxD pins connected to an RS-485 bus. The bus is represented by a series of overlapping waveforms labeled A and B. The settings table below defines the communication parameters for the Master.

Master General	
Multicast Address	98
Device Address	11
Baud rate	9600
Connection Type	Two wire
Parity	No
Stop bits	1
Data bits	8

4. Download settings to Compax3 Servo.

5. Set EasyBuilder system parameter and connect with PLC for communication of HMI and Servo.

Device Address:

Bit/Wor	Device type	Format	Range	Memo
B	R_Low16bit	DDDDDDDDh	0 ~ 99999999f	
B	R_High16bit	DDDDDDDDh	0 ~ 99999999f	
DW	Register_Int	DDDDDD	0 ~ 999999	For Register INT32, U32
DW	Register_float	DDDDDD	0 ~ 999999	For Register INT32, U32
W	Register_Short	DDDDDD	0 ~ 999999	For Register INT16, U16

The range of the address that can be operated depends on the address type.

(For more information, please see PLC Connection Guide)

For example:

If the read / write address is: 1901.2, please enter 190102

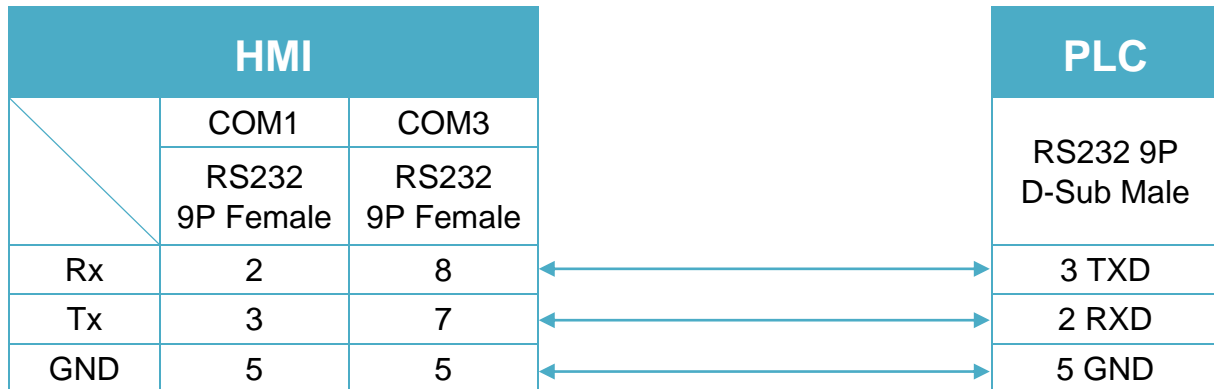
If the read / write address is: 400.1, please enter 40001

Wiring Diagram:

Parker Compax3 PLC X10 : RS232 (Diagram 1 ~ Diagram 3)

Diagram 1

cMT Series	<i>cMT3151</i>
eMT Series	<i>eMT3070 / eMT3105 / eMT3120 / eMT3150</i>
MT-iE	<i>MT8073iE / MT8102iE</i>
MT-XE	<i>MT8092XE</i>
MT-iP	<i>MT6103iP</i>


Diagram 2

cMT Series	<i>cMT-SVR</i>
mTV	<i>mTV</i>
MT-iE	<i>MT8070iE / MT6070iE / MT8100iE / MT8121iE / MT8150iE / MT8071iE / MT6071iE / MT8072iE / MT6072iE / MT8073iE / MT8101iE / MT8102iE / MT8103iE</i>
MT-XE	<i>MT8121XE / MT8150XE / MT8090XE</i>

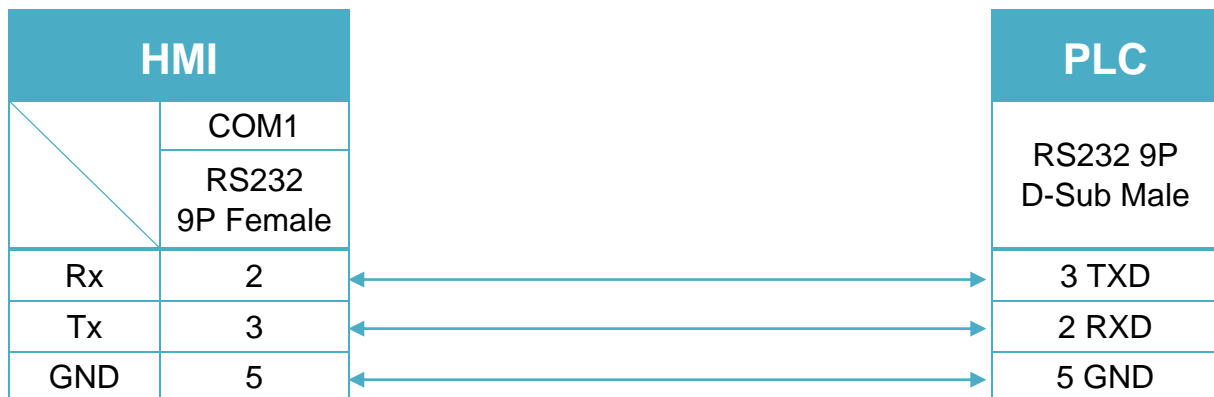


Diagram 3

MT-iE	MT8050iE
MT-iP	MT6051iP / MT6071iP / MT8071iP



Parker Compax3 PLC X10 : RS485 2W (Diagram 4 ~ Diagram 9)

Diagram 4

cMT Series	cMT3151
eMT Series	eMT3070/ eMT3105 / eMT3120 / eMT3150

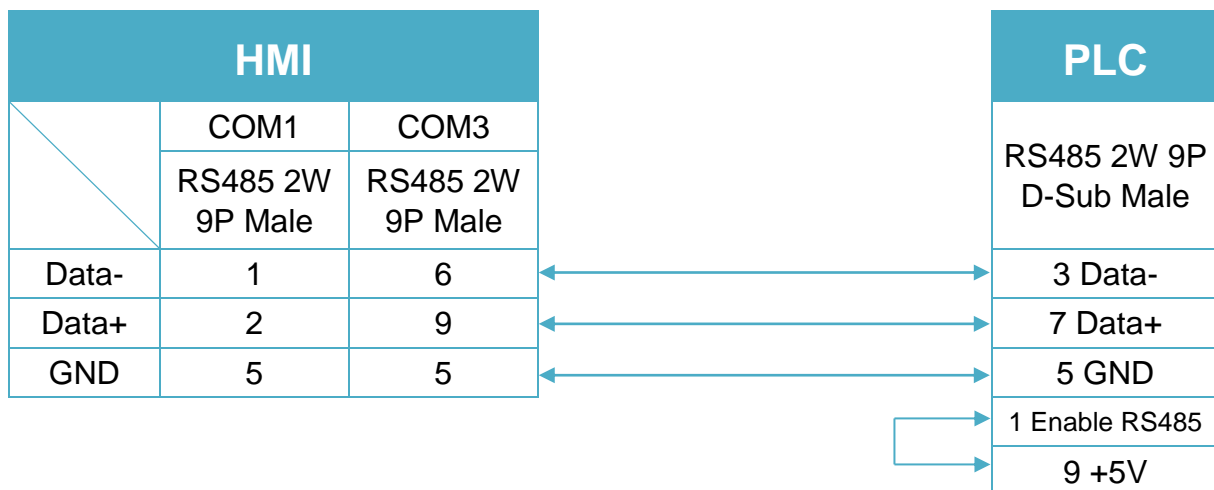


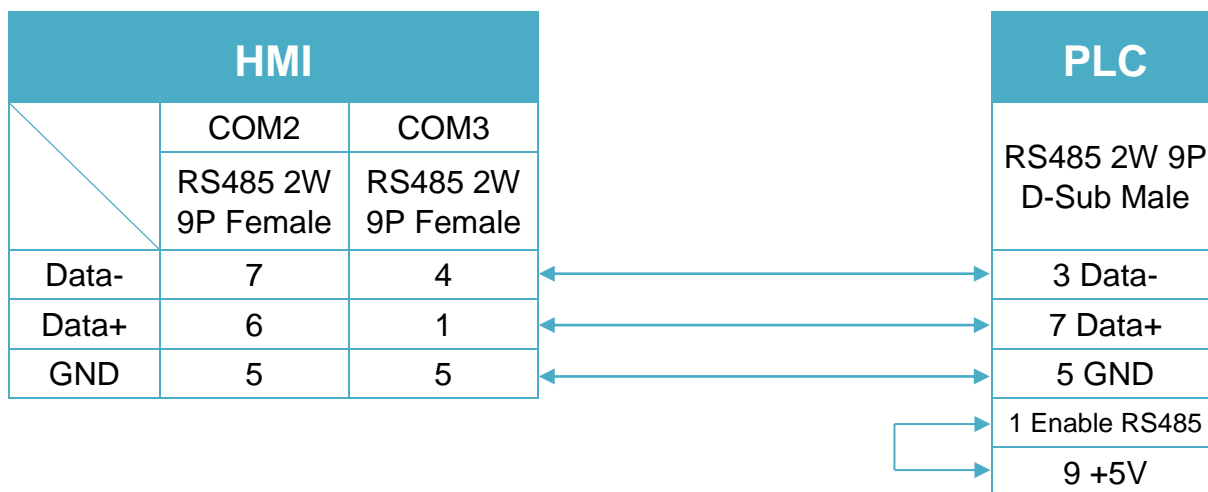
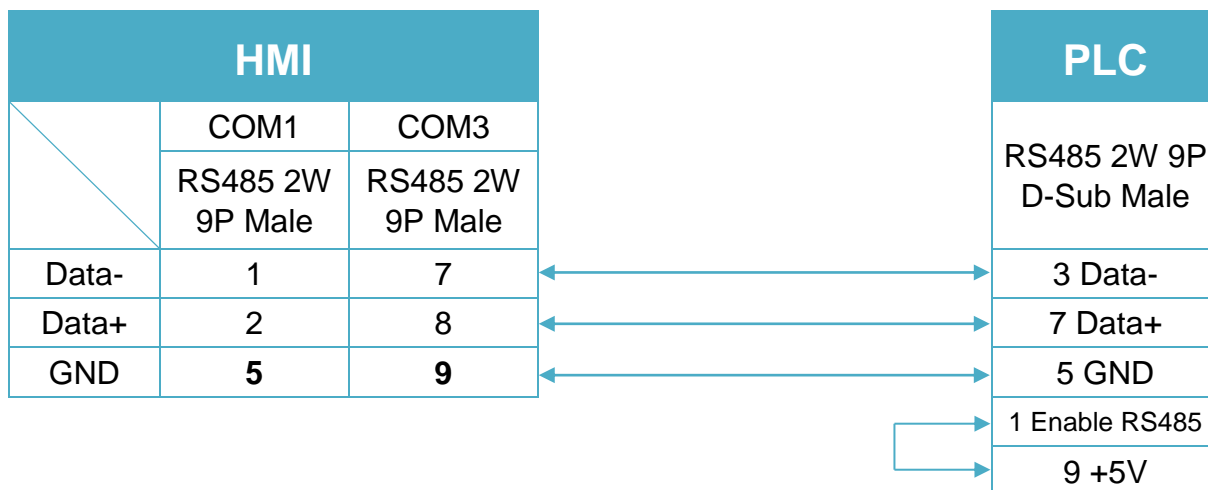
Diagram 5
cMT Series *cMT-SVR*
mTV *mTV*

Diagram 6
MT-iE *MT8070iE / MT6070iE / MT8100iE / MT8121iE / MT8150iE*
MT-XE *MT8121XE / MT8150XE*


Diagram 7

MT-iE	<i>MT8071iE / MT6071iE / MT8072iE / MT6072iE / MT8073iE / MT8101iE / MT8102iE / MT8103iE</i>
MT-XE	<i>MT8090XE / MT8092XE</i>
MT-iP	<i>MT6103iP</i>

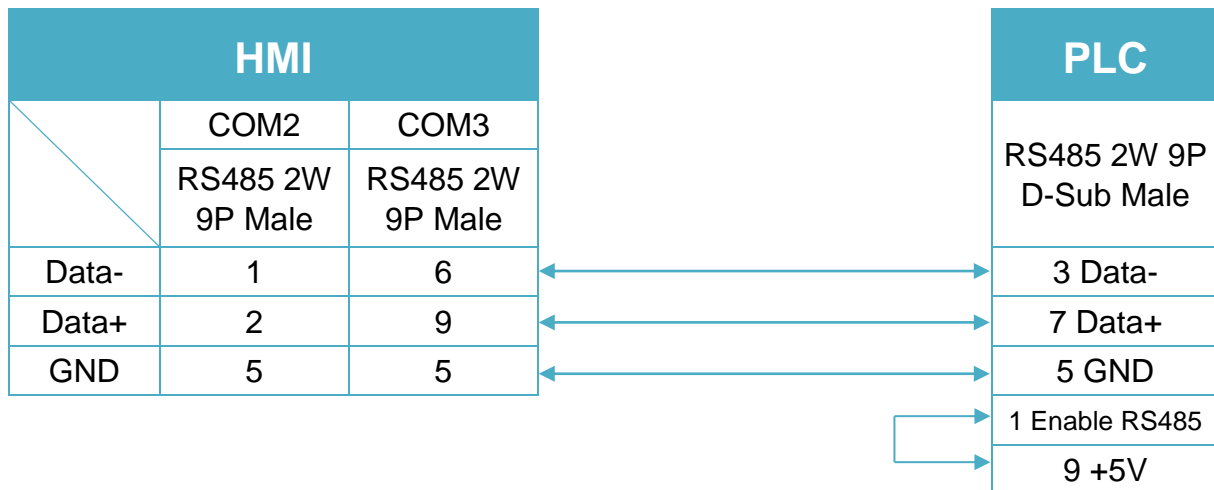


Diagram 8

MT-iE	<i>MT8050iE</i>
MT-iP	<i>MT6051iP</i>

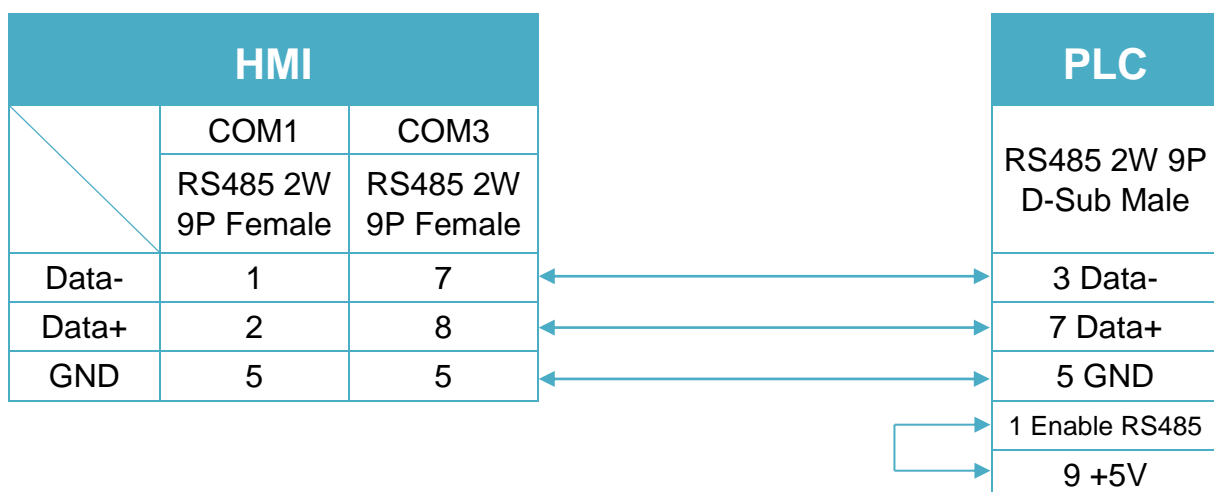
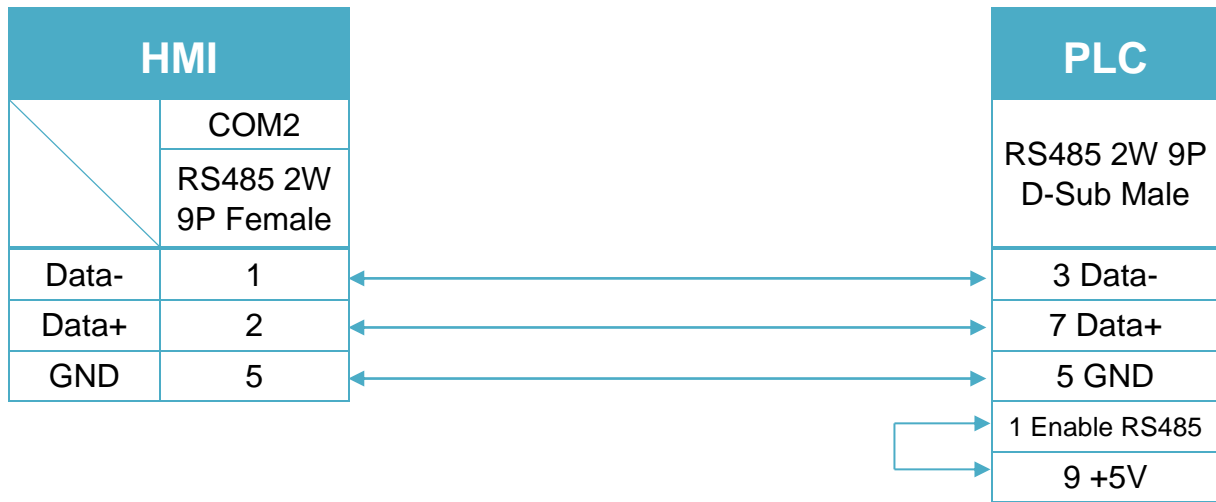


Diagram 9

MT-iP
MT6071iP / MT8071iP


Parker Compumotor 6K Series

HMI Setting:

Parameters	Recommended	Options	Notes
PLC type	Parker Compumotor 6K Series		
PLC I/F	RS232		
Baud rate	9600		
Data bits	8		
Parity	None		
Stop bits	1		
PLC sta. no.	0		

Device Address:

Bit/Word	Device type	Format	Range	Memo
B	VARB(L)	DDDdd	1 ~ 125	The lower 16 bits data of VARB
B	VARB(H)	DDDdd	1 ~ 125	The higher 16 bits data of VARB
D	RUN_PRG	D	0	
DW	VARI	DDD	1 ~ 125	
DW	VAR	DDD	1 ~ 125	Must select single float data mode.

Wiring Diagram:

Diagram 1

cMT Series	<i>cMT3151</i>
eMT Series	<i>eMT3070 / eMT3105 / eMT3120 / eMT3150</i>
MT-iE	<i>MT8073iE / MT8102iE</i>
MT-XE	<i>MT8092XE</i>
MT-iP	<i>MT6103iP</i>

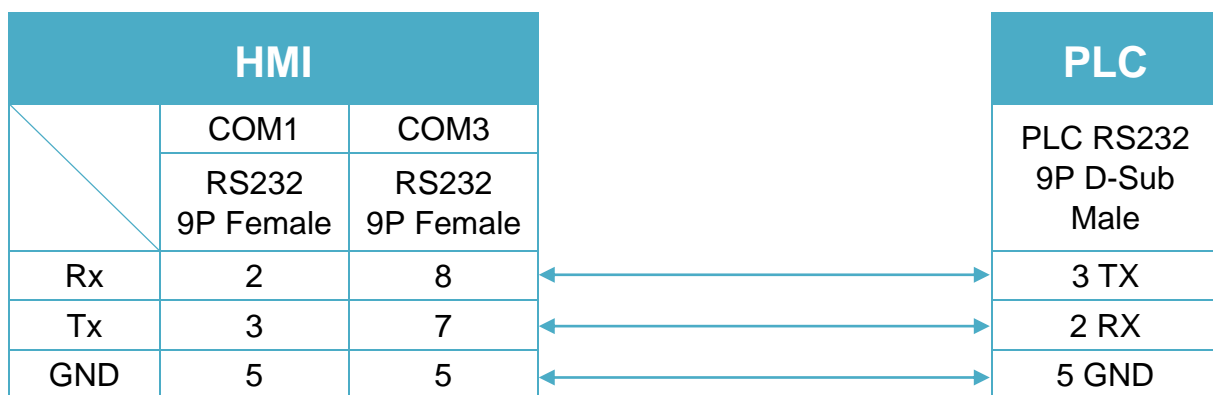


Diagram 2

cMT Series	<i>cMT-SVR</i>
mTV	<i>mTV</i>
MT-iE	<i>MT8070iE / MT6070iE / MT8100iE / MT8121iE / MT8150iE / MT8071iE / MT6071iE / MT8072iE / MT6072iE / MT8073iE / MT8101iE / MT8102iE / MT8103iE</i>
MT-XE	<i>MT8121XE / MT8150XE / MT8090XE</i>

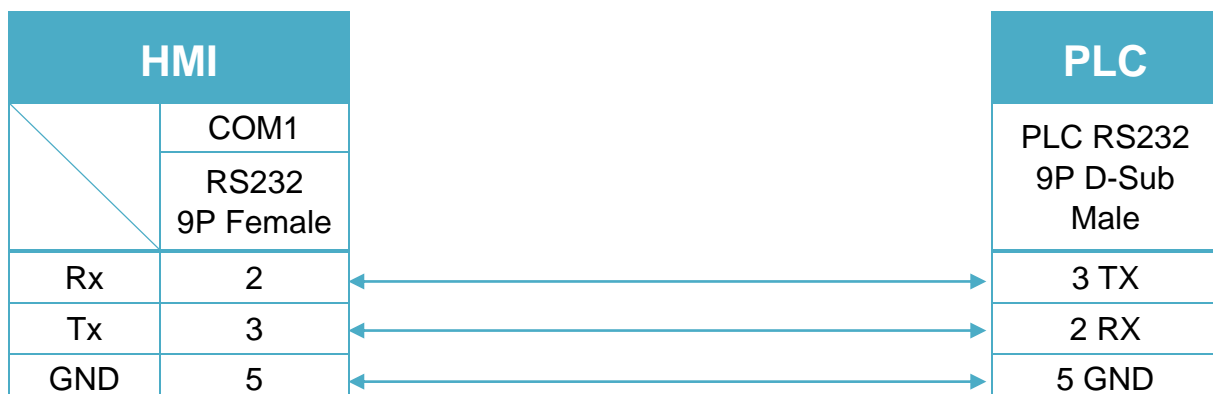
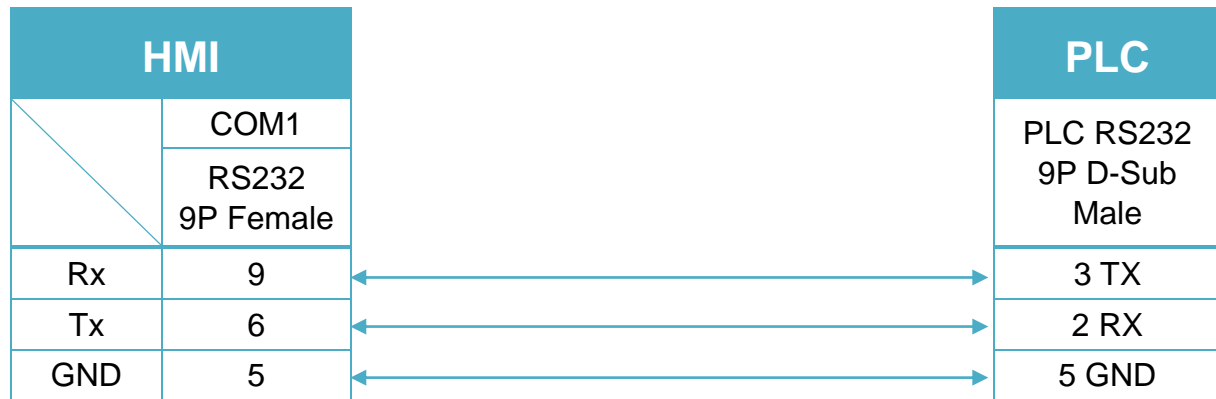


Diagram 3

MT-iE
MT8050iE
MT-iP
MT6051iP / MT6071iP / MT8071iP


Parker SLVD Series

Supported Series : Parker SLVD Servo, SLVD1N, SLVD2N, SLVD5N, SLVD7N, SLVD10N, SLVD15N, SLVD17N.

Website: <http://www.parker.com/portal/site/PARKER/>

HMI Setting:

Parameters	Recommended	Options	Notes
PLC type	Parker SLVD Series		
PLC I/F	RS485 4W		
Baud rate	9600	9600/19200	
Data bits	8	7,8	
Parity	Even	Even, Odd, None	
Stop bits	1	1,2	
PLC sta. no.	0		0-31

Online simulator	YES
-------------------------	-----

Device Address:

Bit/Wor	Device type	Format	Range	Memo
B	Par_Binary	DDDDdd	0 ~ 999915	Set bit parameter
W	Par_One_Word	DDDD	0 ~ 9999	Set 2 bytes parameter
DW	Par_Two_Word	DDDD	0 ~ 9999	Set 4 bytes parameter
W	Par_One_Byte	DDDD	0 ~ 9999	Set 1 byte parameter
W	RESET	D	0	
W	RUN	D	0	

Wiring Diagram:

Diagram 1

cMT Series	<i>cMT3151</i>
eMT Series	<i>eMT3070 / eMT3105 / eMT3120 / eMT3150</i>
MT-iE	<i>MT8070iE / MT6070iE / MT8100iE / MT8121iE / MT8150iE</i>
MT-XE	<i>MT8121XE / MT8150XE</i>

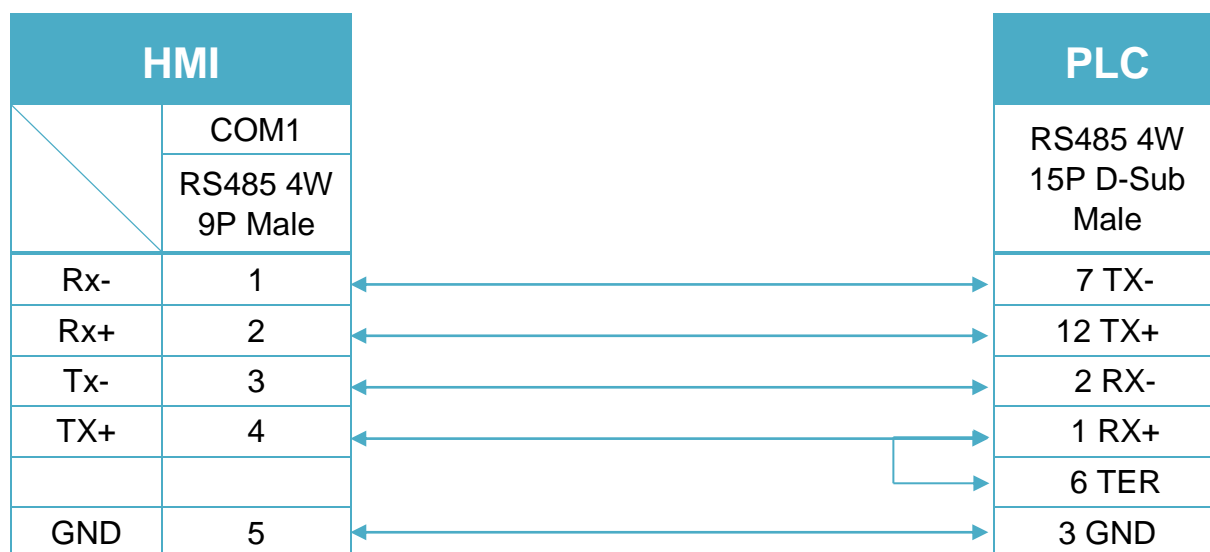


Diagram 2

cMT Series	<i>cMT-SVR</i>
mTV	<i>mTV</i>

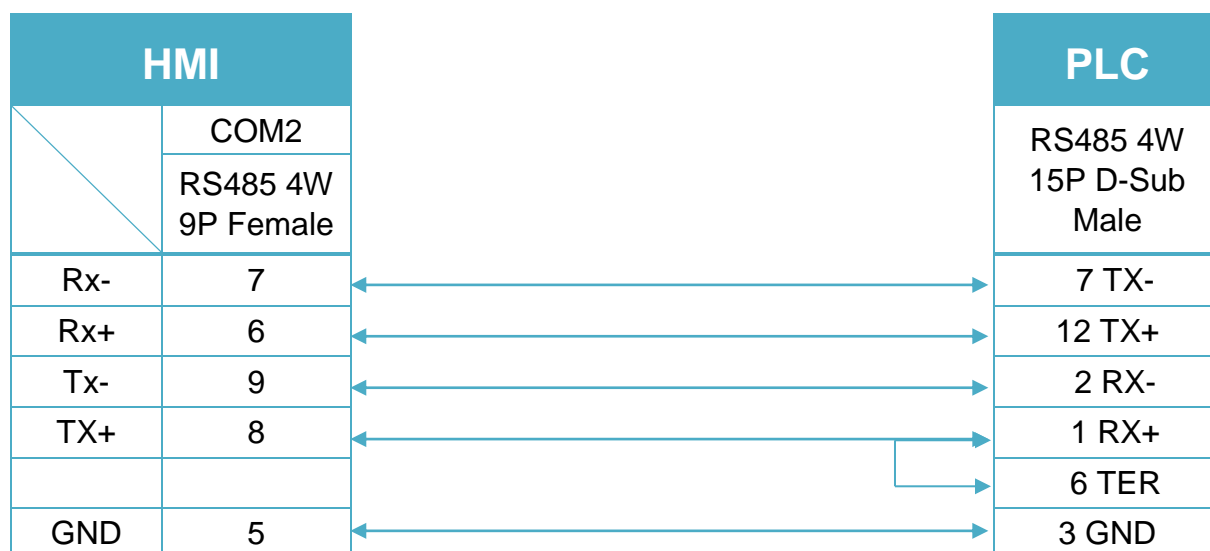


Diagram 3

MT-iE	<i>MT8071iE / MT6071iE / MT8072iE / MT6072iE / MT8073iE / MT8101iE / MT8102iE / MT8103iE</i>
MT-XE	<i>MT8090XE / MT8092XE</i>
MT-iP	<i>MT6071iP / MT8071iP / MT6103iP</i>

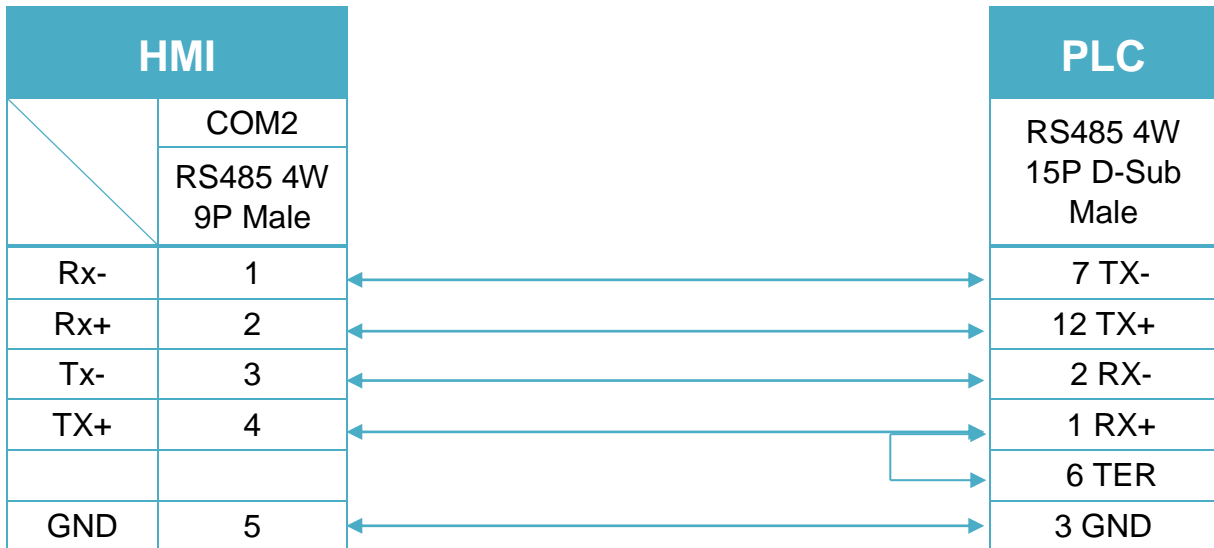
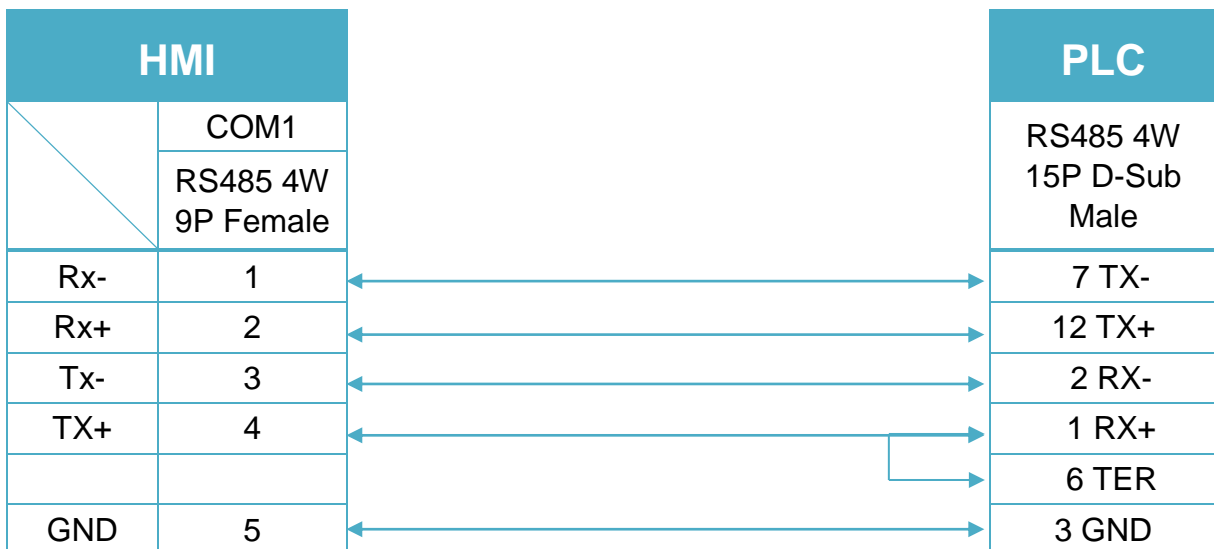


Diagram 4

MT-iE	<i>MT8050iE</i>
MT-iP	<i>MT6051iP</i>



PATLITE VM/VMS Series

Supported Series: PATLITE VM/VMS Series

Website: <http://www.patlite.co.jp>

HMI Setting:

Parameters	Recommended	Options	Notes
PLC type	PATLITE VM/VMS Series		
PLC I/F	RS232	RS232 / RS485 2W / RS485 4W/ Ethernet	
Baud rate	38400	9600 ~ 115200	
Data bits	8	7 , 8	
Parity	Even	Even , Odd , None	
Stop bits	1	1 , 2	
PLC sta. no.	0	0 ~ 31	
Port no.	10600		

Device Address:

Bit/Word	Device type	Format	Range	Memo
B	LAW_bit	HHHHh	1 ~ 7FFE	h : Bit no.(0 ~ f)
W	LAW	HHHH	1 ~ 7FFE	
W	LAW6Mode	H	6	
W	LAW6Style	H	6	
W	LAW6Scale	H	6	
W	LAW6BG_c	H	6	
W	LAW6Chr_c	H	6	
W	UNI2sJIS	HHHH	1 ~ 7FFE	LAW : Unicode to shift-JIS
W	UNI2BIG5	HHHH	1 ~ 7FFE	LAW : Unicode to BIG5

Wiring Diagram:

RS-232 9P D-Sub (Diagram 1 ~ Diagram 3)

Diagram 1

cMT Series	<i>cMT3151</i>
eMT Series	<i>eMT3070 / eMT3105 / eMT3120 / eMT3150</i>
MT-iE	<i>MT8073iE / MT8102iE</i>
MT-XE	<i>MT8092XE</i>
MT-iP	<i>MT6103iP</i>

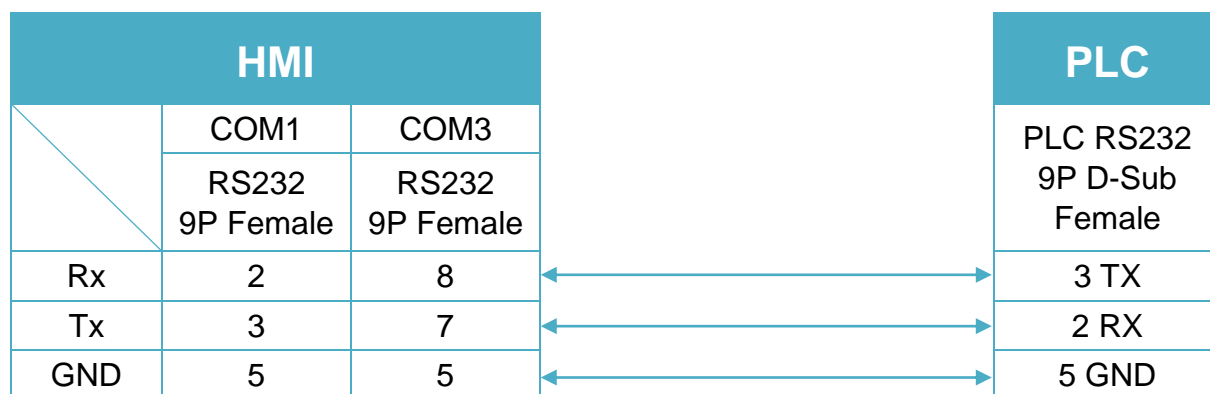


Diagram 2

cMT Series	cMT-SVR
mTV	mTV
MT-iE	MT8070iE / MT6070iE / MT8100iE / MT8121iE / MT8150iE / MT8071iE / MT6071iE / MT8072iE / MT6072iE / MT8073iE / MT8101iE / MT8102iE / MT8103iE
MT-XE	MT8121XE / MT8150XE / MT8090XE

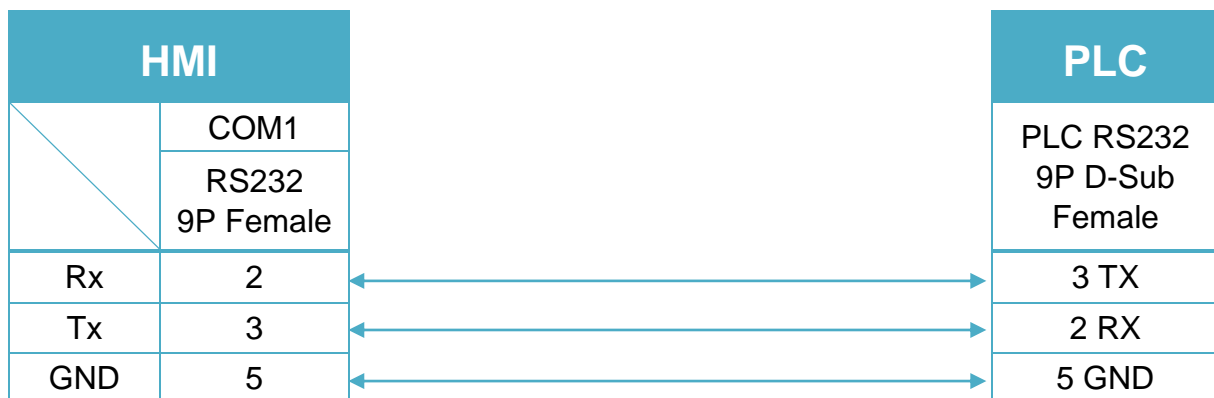


Diagram 3

MT-iE	MT8050iE
MT-iP	MT6051iP / MT6071iP / MT8071iP



RS-485 2W Terminal (Diagram 4 ~ Diagram9)

Diagram 4

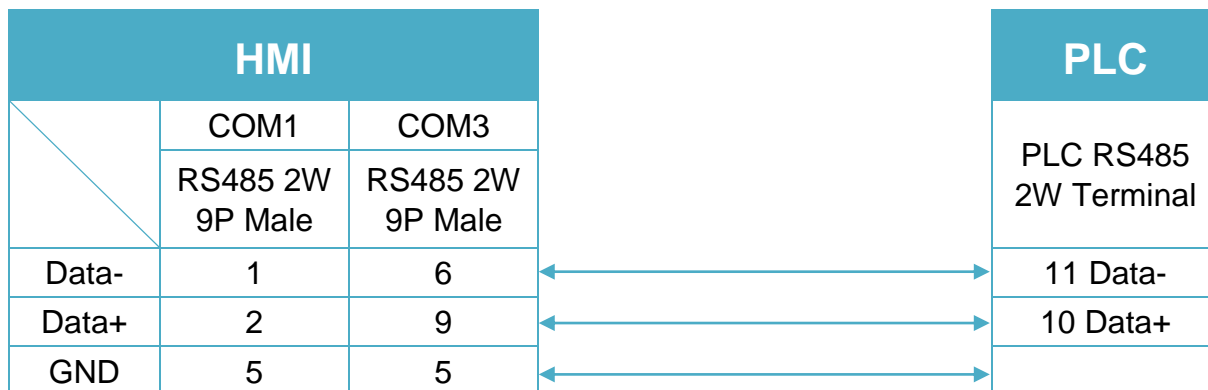
cMT Series
cMT3151
eMT Series
eMT3070/ eMT3105 / eMT3120 / eMT3150


Diagram 5

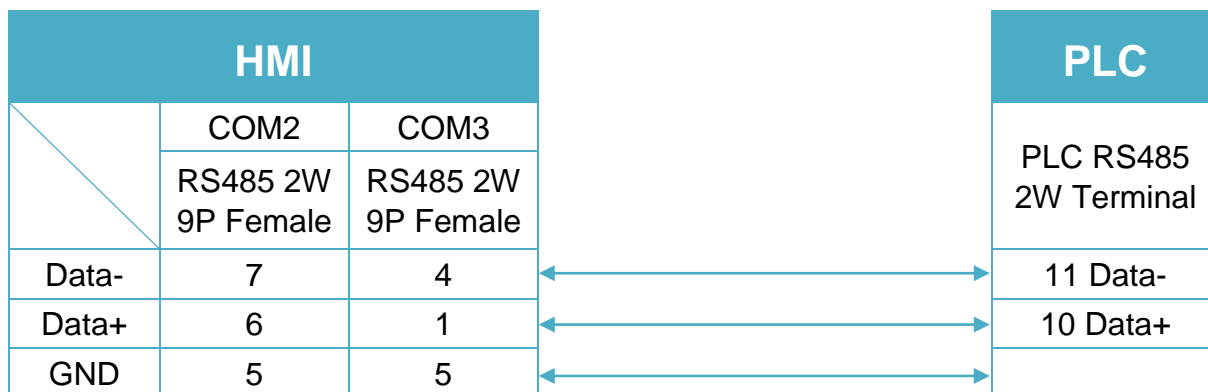
cMT Series
cMT-SVR
mTV
mTV


Diagram 6

MT-iE *MT8070iE / MT6070iE / MT8100iE / MT8121iE / MT8150iE*

MT-XE *MT8121XE / MT8150XE*

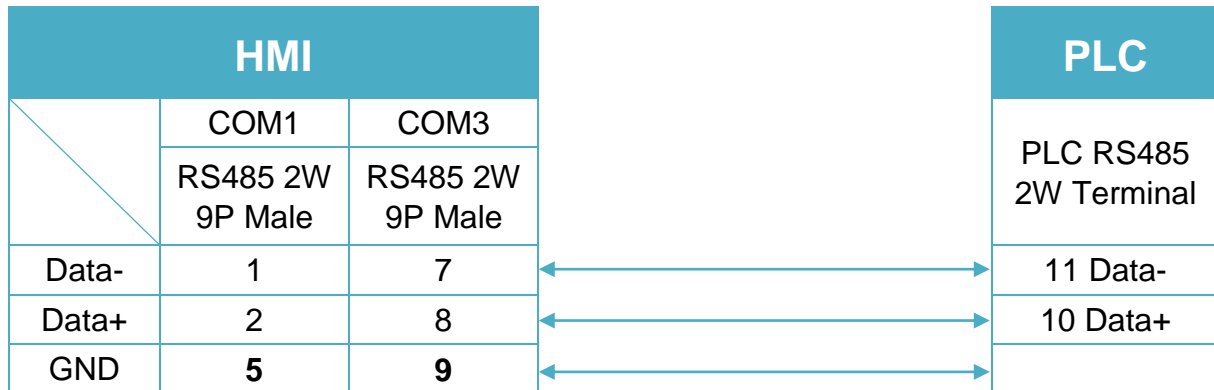


Diagram 7

MT-iE *MT8071iE / MT6071iE / MT8072iE / MT6072iE / MT8073iE / MT8101iE / MT8102iE / MT8103iE*

MT-XE *MT8090XE / MT8092XE*

MT-iP *MT6103iP*

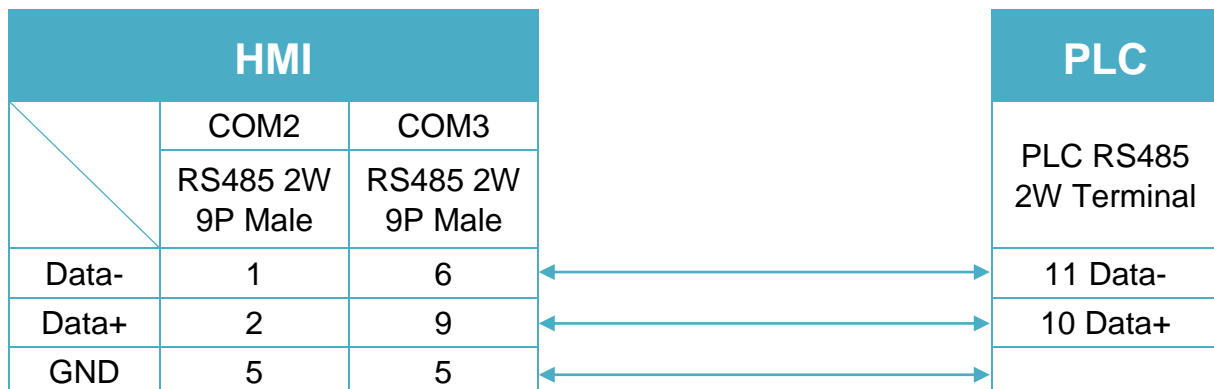
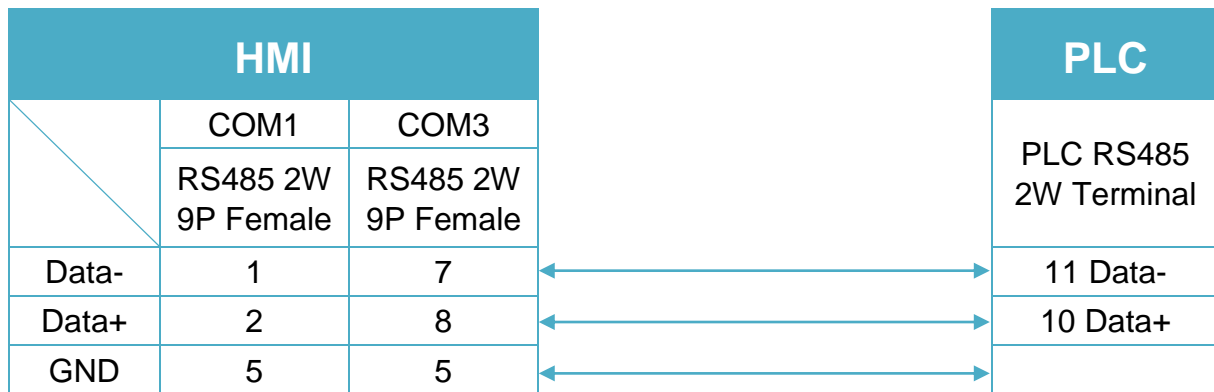
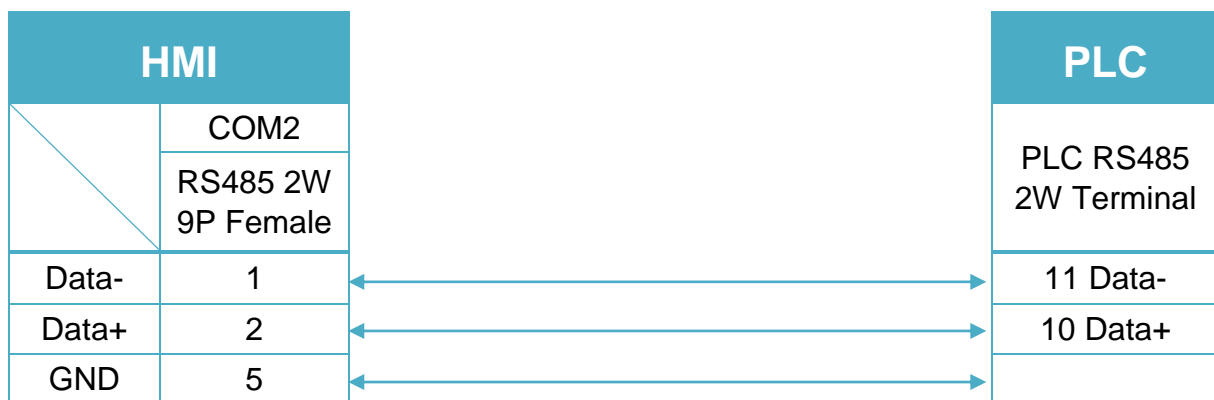


Diagram 8
MT-iE *MT8050iE*
MT-iP *MT6051iP*

Diagram 9
MT-iP *MT6071iP / MT8071iP*


RS-485 2W Terminal (Diagram 10 ~ Diagram 13)

Diagram 10

cMT Series	<i>cMT3151</i>
eMT Series	<i>eMT3070 / eMT3105 / eMT3120 / eMT3150</i>
MT-iE	<i>MT8070iE / MT6070iE / MT8100iE / MT8121iE / MT8150iE</i>
MT-XE	<i>MT8121XE / MT8150XE</i>

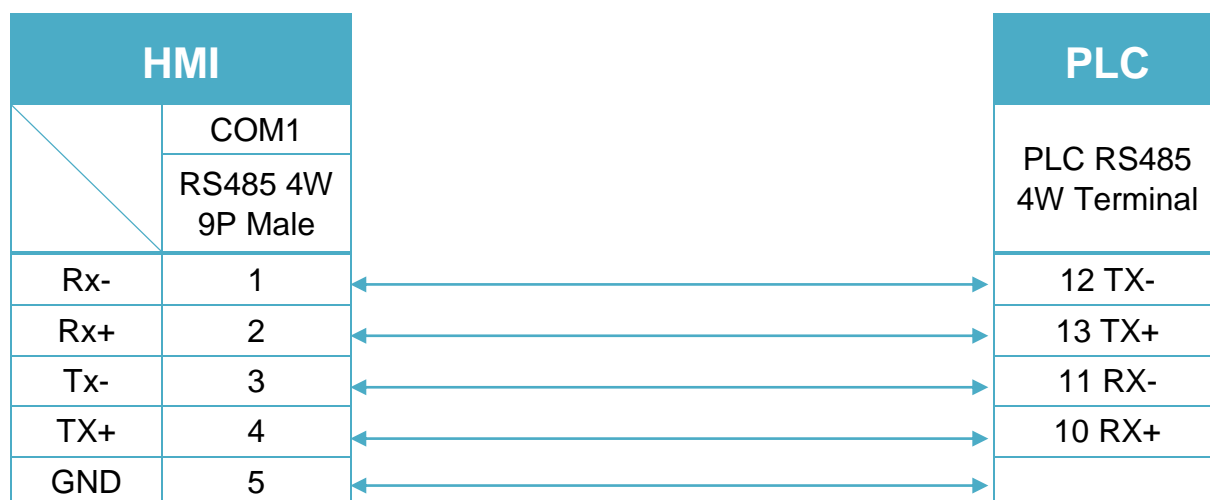


Diagram 11

cMT Series	<i>cMT-SVR</i>
mTV	<i>mTV</i>

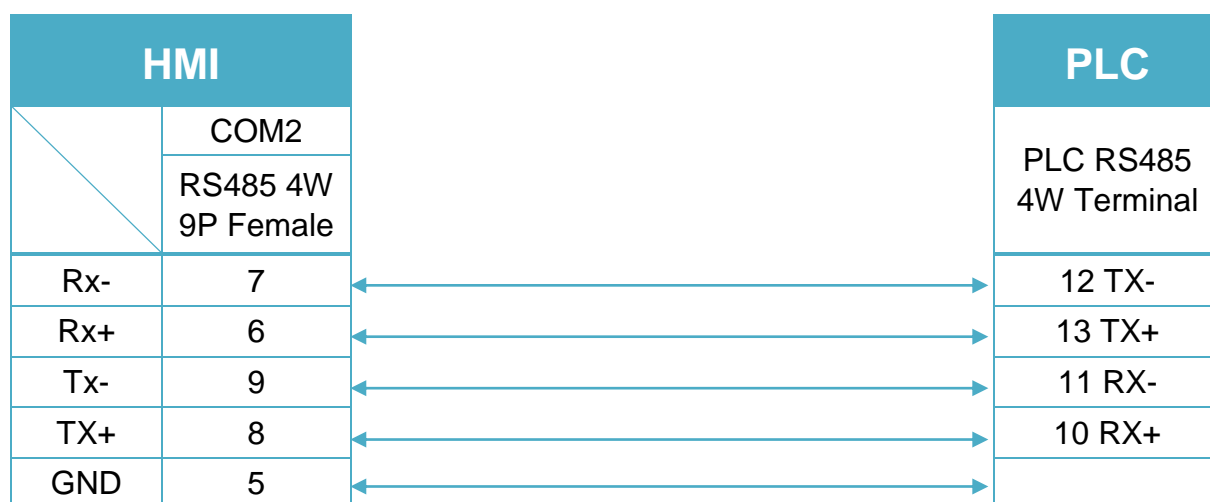


Diagram 12

MT-iE	<i>MT8071iE / MT6071iE / MT8072iE / MT6072iE / MT8073iE / MT8101iE / MT8102iE / MT8103iE</i>
MT-XE	<i>MT8090XE / MT8092XE</i>
MT-iP	<i>MT6071iP / MT8071iP / MT6103iP</i>

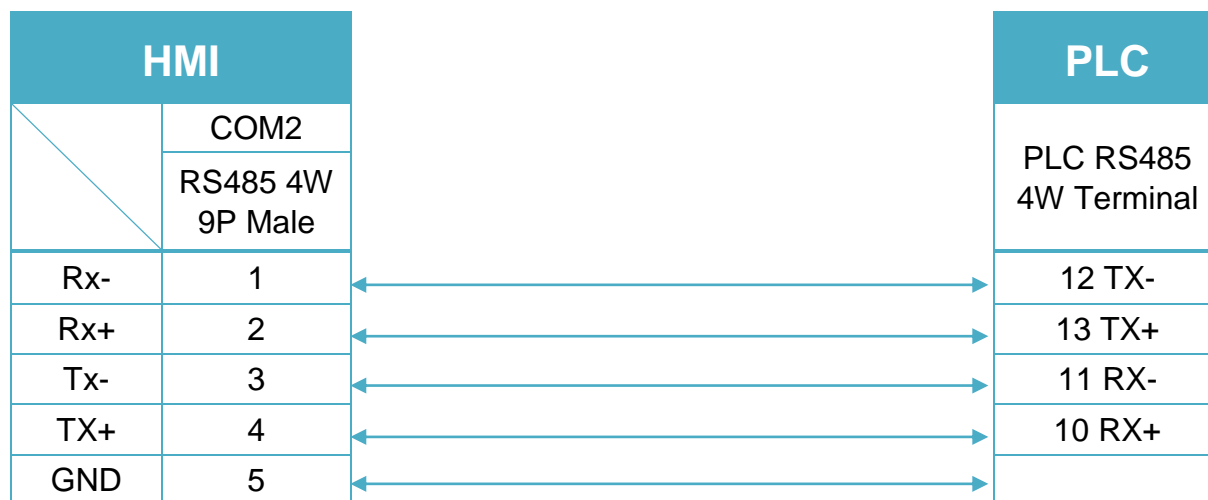


Diagram 13

MT-iE	<i>MT8050iE</i>
MT-iP	<i>MT6051iP</i>

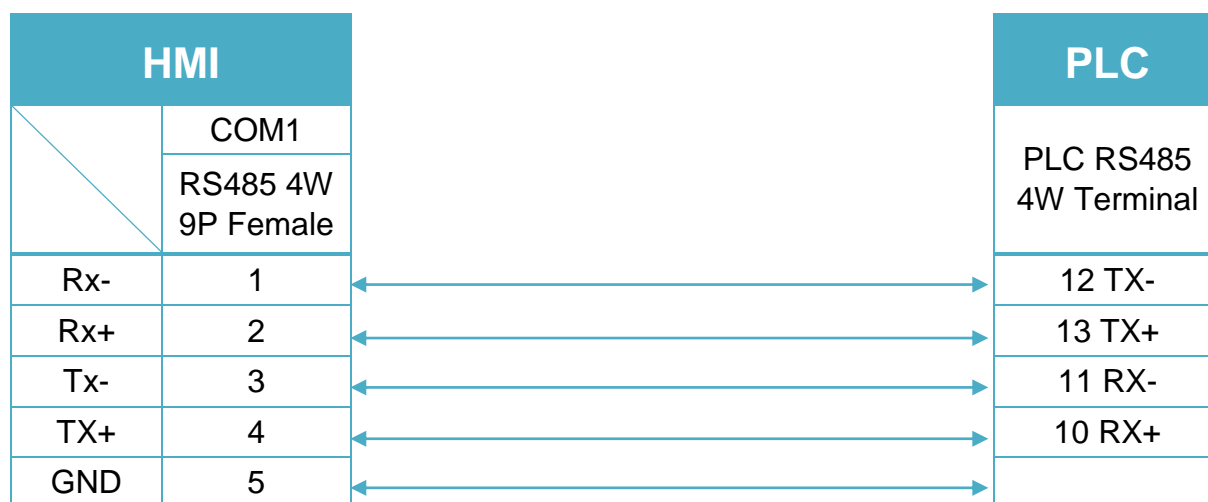
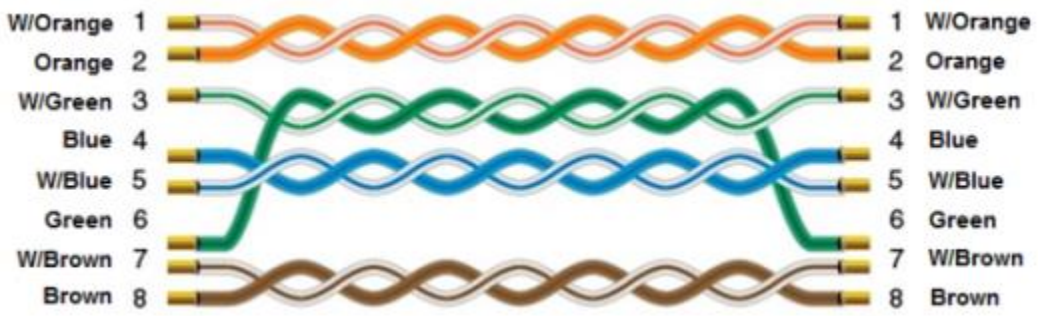


Diagram 14

Ethernet cable:



Rockwell CompactLogix - Free Tag Names

Rockwell ControlLogix, CompactLogix, FlexLogix CH0 DF1.

Website: <http://www.ab.com>

HMI Setting:

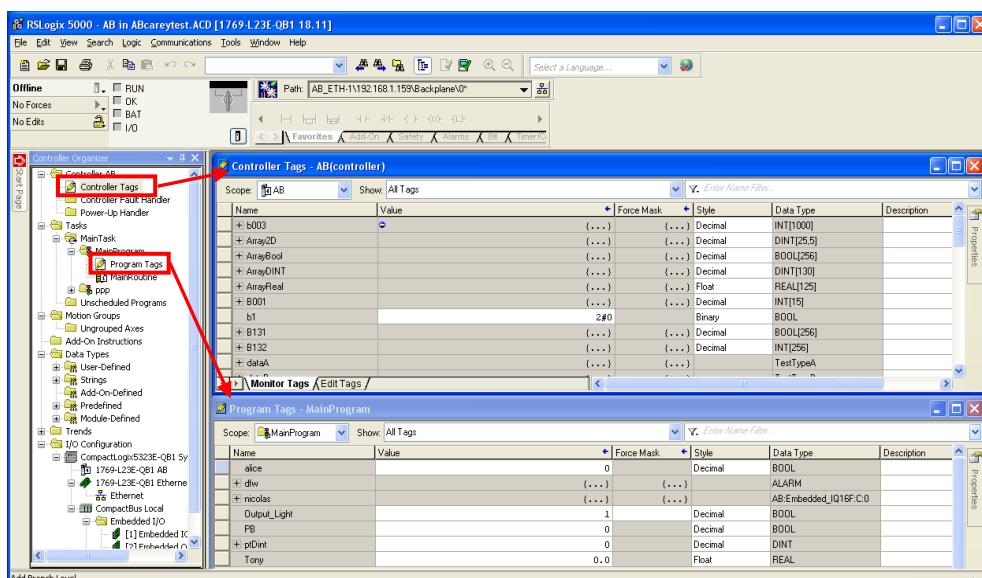
Parameters	Recommended	Options	Notes
PLC type	Rockwell CompactLogix - Free Tag Names		
PLC I/F	RS232		
Baud rate	19200	9600, 19200, 38400	
Data bits	8	8	
Parity	None	Even, Odd, None	
Stop bits	1	1	
Turn around delay	10	10 ~ 100	*Note
HMI sta. no.	0		
PLC sta. no.	1	1-31	

*Note : When the communication is not stable, please adjust the parameter of [turn around delay] till the communication is normal.

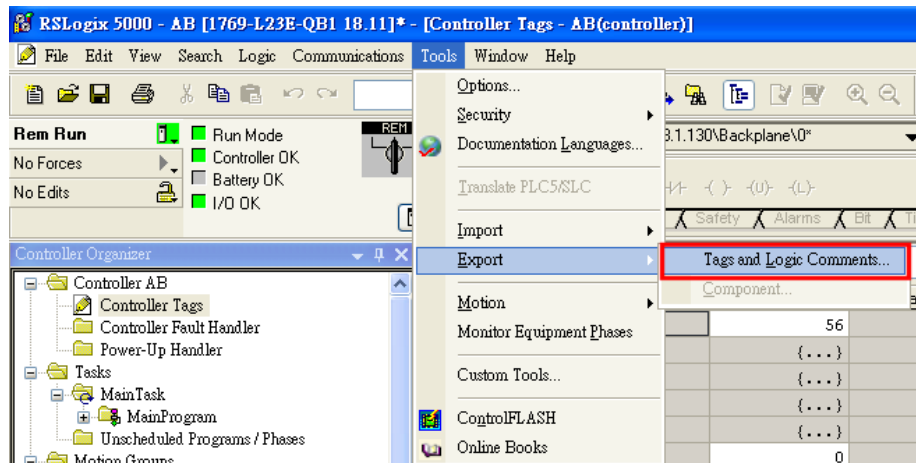
PLC Setting:

Communication mode	DF1 No Handshake protocol 19200, None, 8, 1 (default) Error Check: BCC, Station Address: 1
---------------------------	---

1. Create new tags (Controller Tags and Program Tags supported).



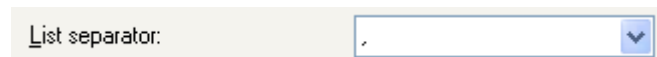
2. Export Tag data to CSV file. ([Tools] » [Export] » [Tags and Logic Comments])



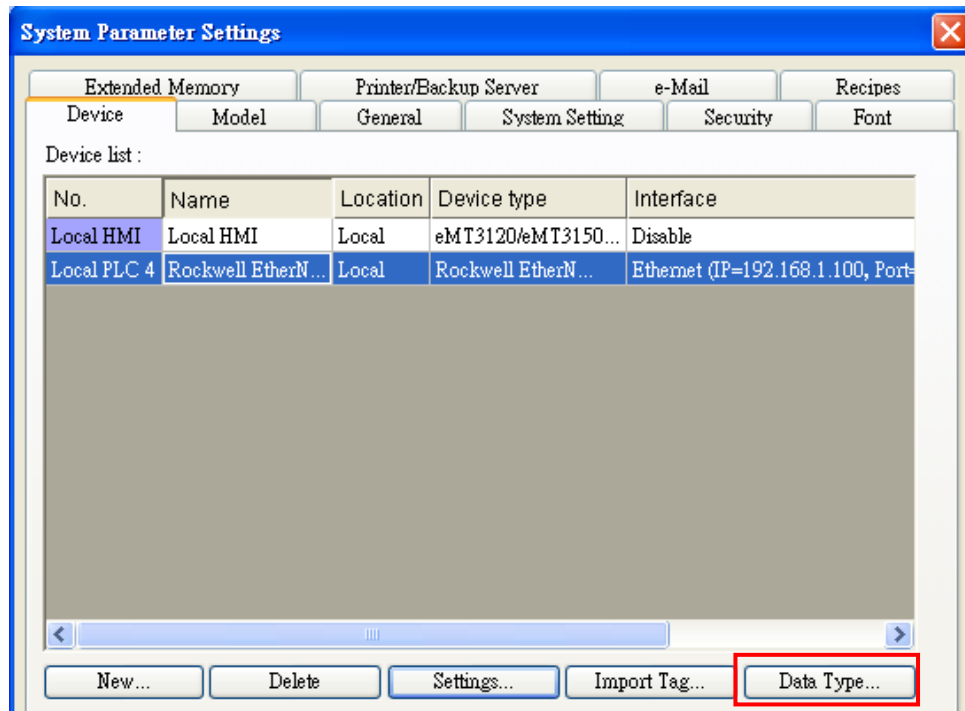
Note: The separator character in CSV file must be a comma “,” otherwise the file is invalid.

TAG	B003	INT[20]	(RADIX := Decimal, PLCMappingFile := 3, Constant := false, ExternalAccess := Read/Write)
TAG	B012	INT[32]	(RADIX := Decimal, PLCMappingFile := 12, Constant := false, ExternalAccess := Read/Write)
TAG	B015	BOOL	(RADIX := Binary, Constant := false, ExternalAccess := Read/Write)

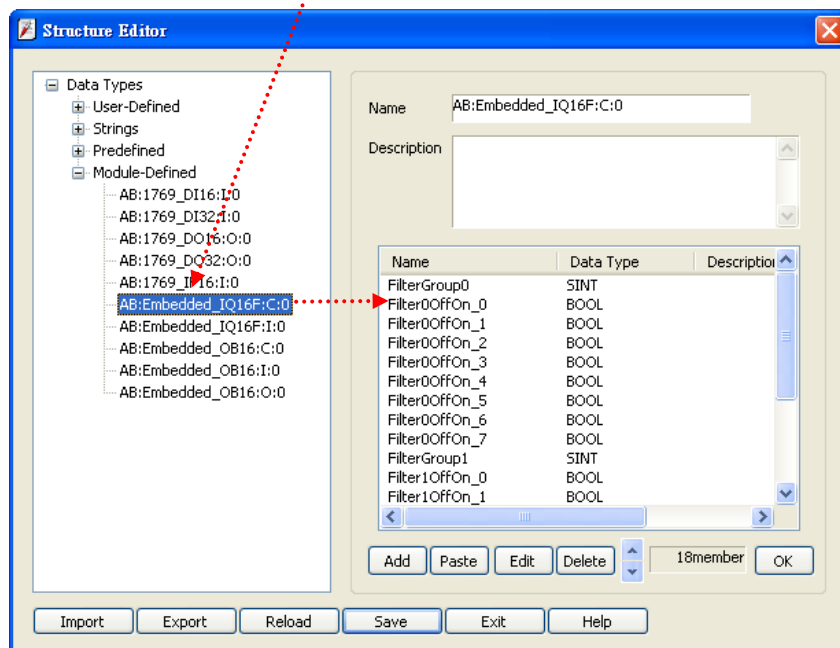
The directory of changing system settings: [Control Panel] » [Date, Time, Language, and Regional Options] » [Change the format of numbers, dates, and times] » [Customize] » [List separator]. Please select “,” and export CSV file after setting.



- Open EasyBuilder project file, select the driver and set communication parameter. Click **[Data Type]** to open **[Structure Editor]** and edit the data type of the tags.



TYPE	SCOPE	NAME	DESCRIPTION	DATATYPE	SPECIFIER	ATTRIBUTES
TAG		Local:1:C		AB:Embedded_IQ16F:C:0		
TAG		Local:1:I		AB:Embedded_IQ16F:I:0		
TAG		Local:2:C		AB:Embedded_OB16:C:0		
TAG		Local:2:I		AB:Embedded_OB16:I:0		
TAG		Local:2:O		AB:Embedded_OB16:O:0		



4. In **[Structure Editor]** edit the data type of **[Program Tag]**.

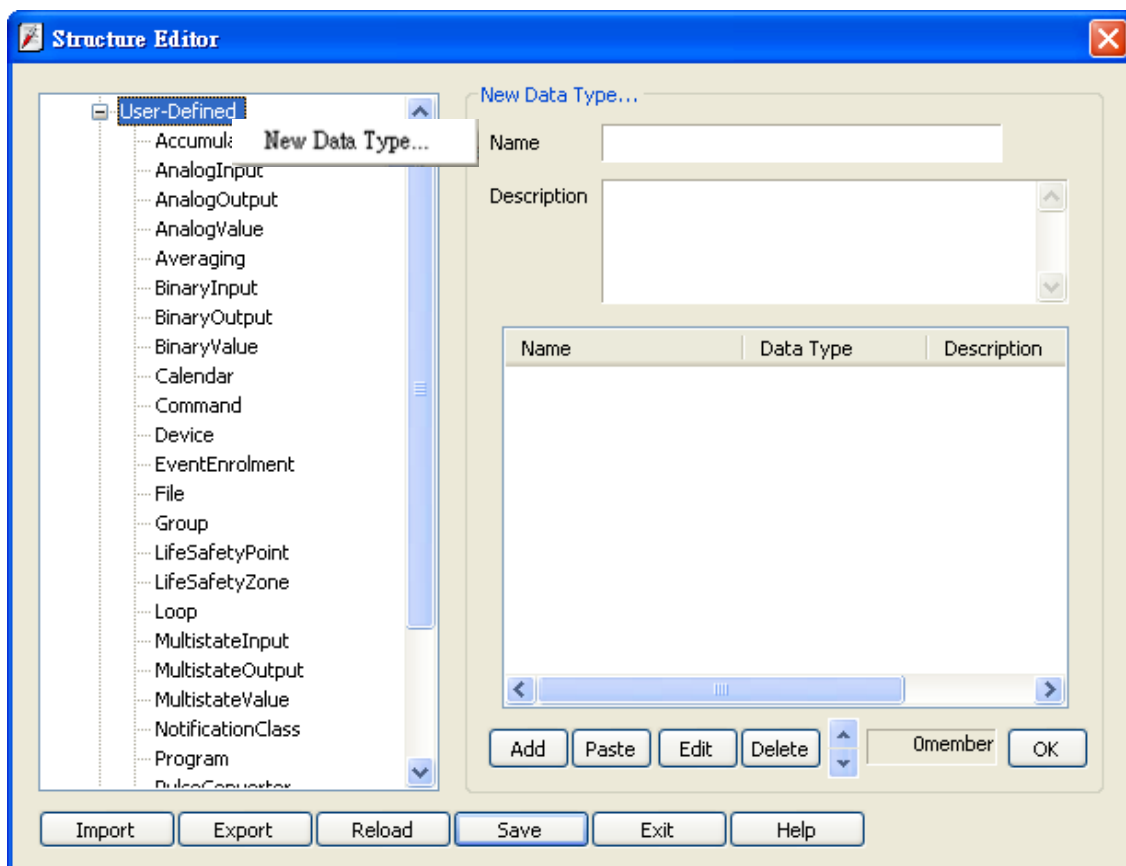
The imported csv file is shown below:

Note: The Program Tag can directly be imported in EasyBuilder Pro V3.00.05, EasyBuilder 8000 V4.65.08, and the later versions. Please go to step 5 without editing manually.

7	TYPE	SCOPE	NAME	DESCRIPTION	DATATYPE	SPECIFIER
8	TAG		Local:1:C		AB:Embedded_IQ16F:C:0	
9	TAG		Local:1:I		AB:Embedded_IQ16F:I:0	
10	TAG		Local:2:C		AB:Embedded_OB16:C:0	
11	TAG		Local:2:I		AB:Embedded_OB16:I:0	
12	TAG		Local:2:O		AB:Embedded_OB16:O:0	
13	TAG		PB_ControllerTag		BOOL	
14	TYPE	SCOPE	NAME	DESCRIPTION	DATATYPE	SPECIFIER
15	TAG	ConveyorProgram	Output_Conveyor			Local:2:O.Data.2
16	TAG	ConveyorProgram	PB_Conveyor		BOOL	
17	TYPE	SCOPE	NAME	DESCRIPTION	DATATYPE	SPECIFIER
18	TAG	MainProgram	Output_Light			Local:2:O.Data.1
19	TAG	MainProgram	PB		BOOL	

Step 1

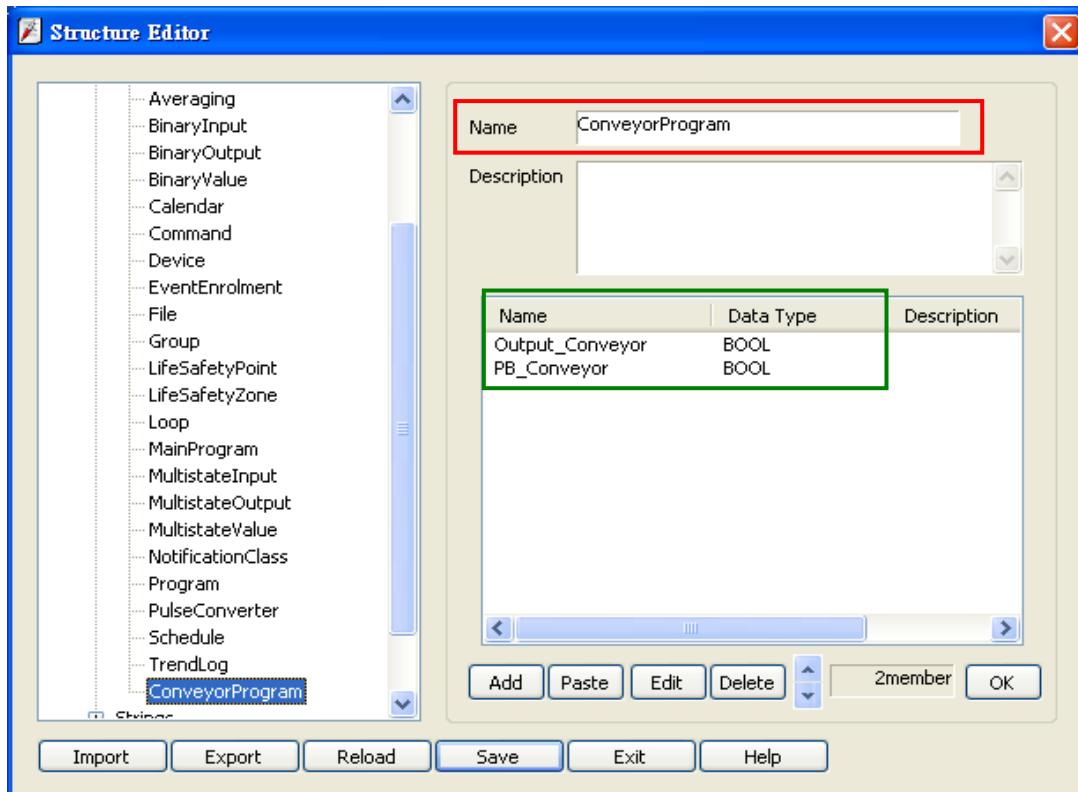
Right click on **[Structure Editor]** » **[User-Defined]** to add a **[new data type]**.



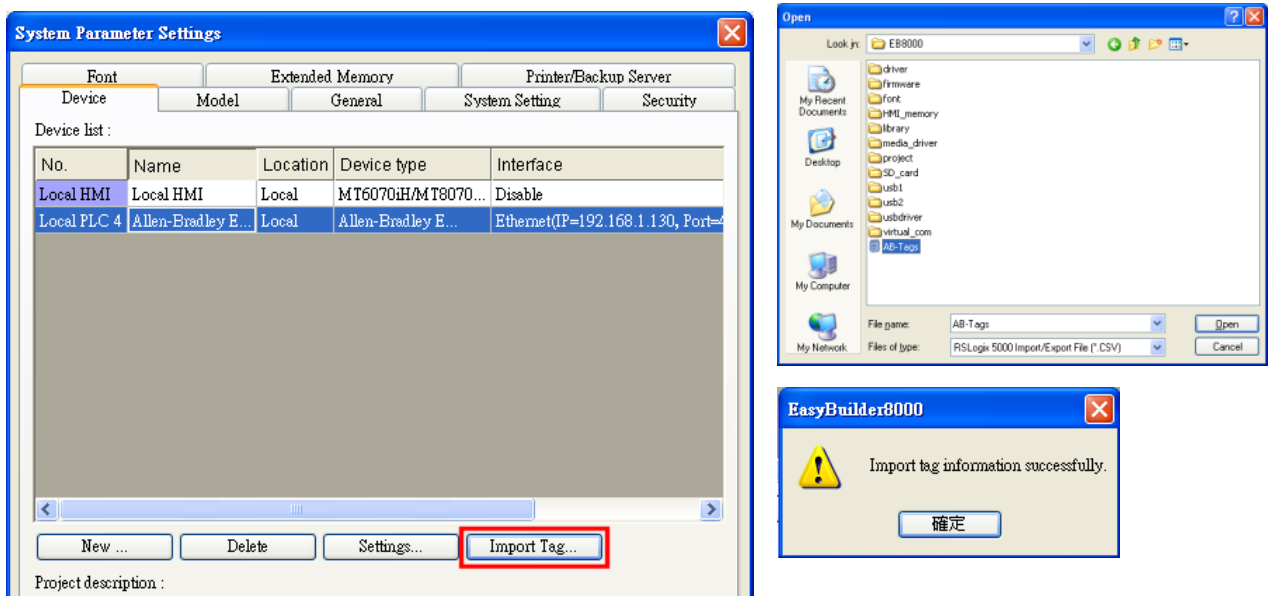
Step 2

After adding all Program Tags, click **[OK]** » **[Save]** » **[Exit]** to leave the editor dialog.

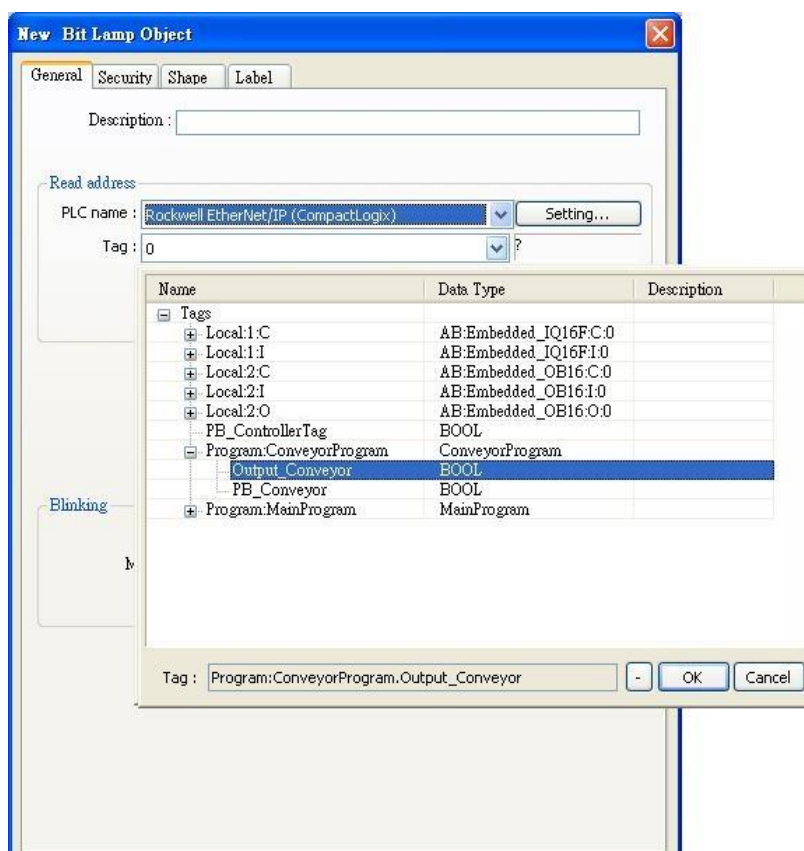
TYPE	SCOPE	NAME	DESCRIPTION	DATATYPE	SPECIFIER
ALIAS	ConveyorProgram	Output_Conveyor			Local:2:O.Data.2
TAG	ConveyorProgram	PB_Conveyor		BOOL	
TYPE	SCOPE	NAME	DESCRIPTION	DATATYPE	SPECIFIER
ALIAS	MainProgram	Output_Light			Local:2:O.Data.1
TAG	MainProgram	PB		BOOL	



- In **[System Parameter Settings]**, click **[Import Tag]**, select the csv file. After importing a message window is displayed.



- In the object property dialog, select PLC Tag address.



Device Address:

PLC Data Type	Bit/Word	EasyBuilder Data Format	Memo
BOOL	Boolean	Bit object	
BitArray			
SINT			
INT	Integer	16-bit signed, ASCII	-32768 ~ 32767
DINT	Double Integer	32-bit signed	$-2^{31} \sim (2^{31}-1)$
REAL	Single Precision Float	32-bit Float	IEEE 754

Wiring Diagram:

Diagram 1

cMT Series	<i>cMT3151</i>
eMT Series	<i>eMT3070 / eMT3105 / eMT3120 / eMT3150</i>
MT-iE	<i>MT8073iE / MT8102iE</i>
MT-XE	<i>MT8092XE</i>
MT-iP	<i>MT6103iP</i>

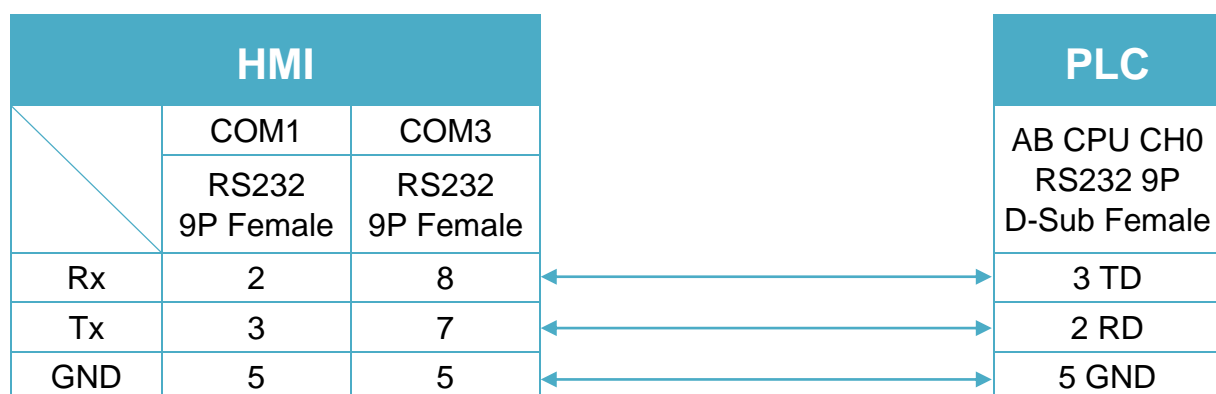


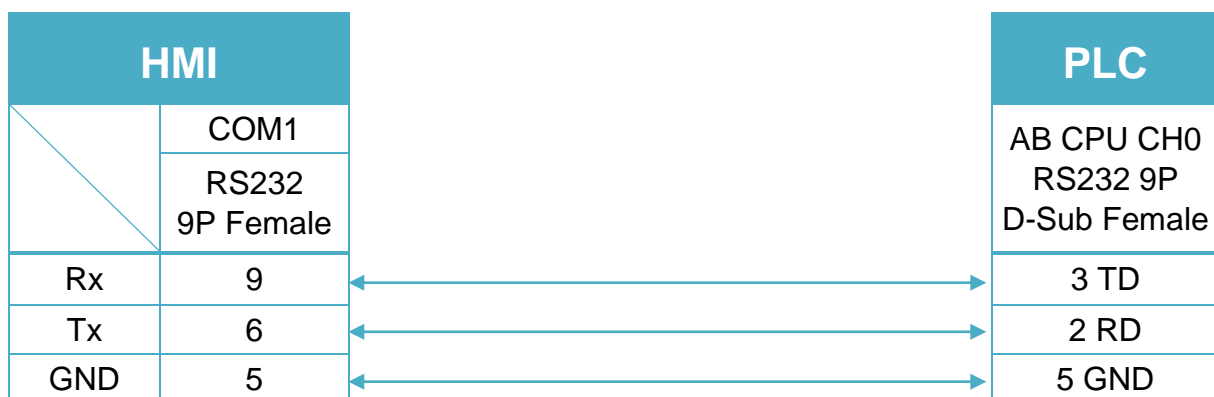
Diagram 2

cMT Series	cMT-SVR
mTV	mTV
MT-iE	MT8070iE / MT6070iE / MT8100iE / MT8121iE / MT8150iE / MT8071iE / MT6071iE / MT8072iE / MT6072iE / MT8073iE / MT8101iE / MT8102iE / MT8103iE
MT-XE	MT8121XE / MT8150XE / MT8090XE



Diagram 3

MT-iE	MT8050iE
MT-iP	MT6051iP / MT6071iP / MT8071iP



Rockwell CompactLogix/FlexLogix

Supported Series: Rockwell ControlLogix, CompactLogix, FlexLogix CH0 DF1.

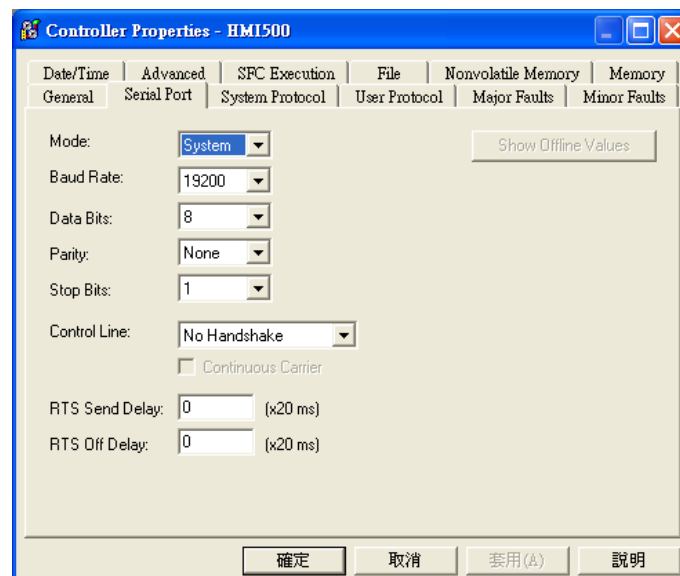
Website: <http://www.ab.com>

HMI Setting:

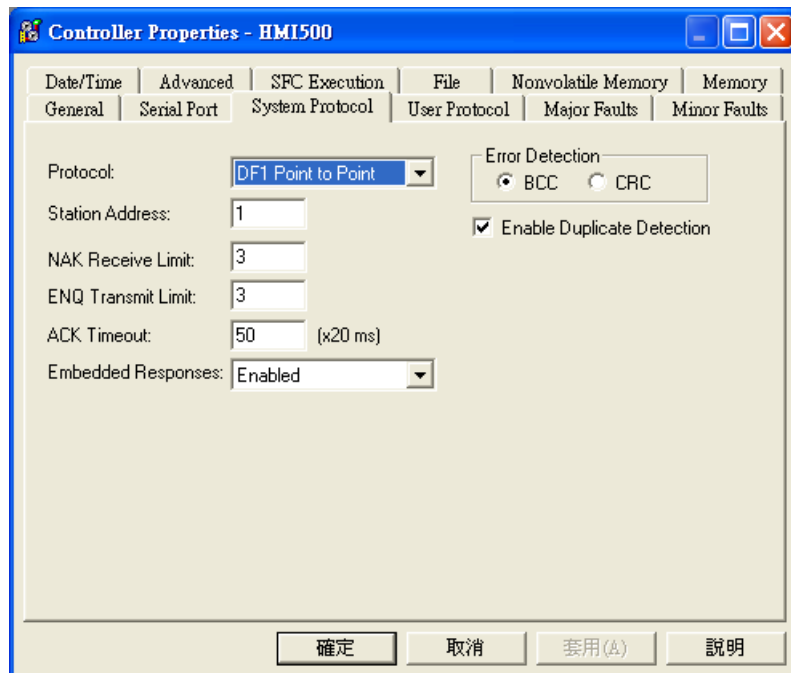
Parameters	Recommended	Options	Notes
PLC type	Rockwell CompactLogix/FlexLogix		
PLC I/F	RS232		
Baud rate	19200	9600, 19200, 38400	
Data bits	8	8	
Parity	None	Even, Odd, None	
Stop bits	1	1	
HMI sta. no.	0		
PLC sta. no.	1	1-31	

PLC Setting:

Communication mode	DF1 No Handshake protocol 19200, None, 8, 1 (default) Error Check: BCC, Station Address: 1
---------------------------	---



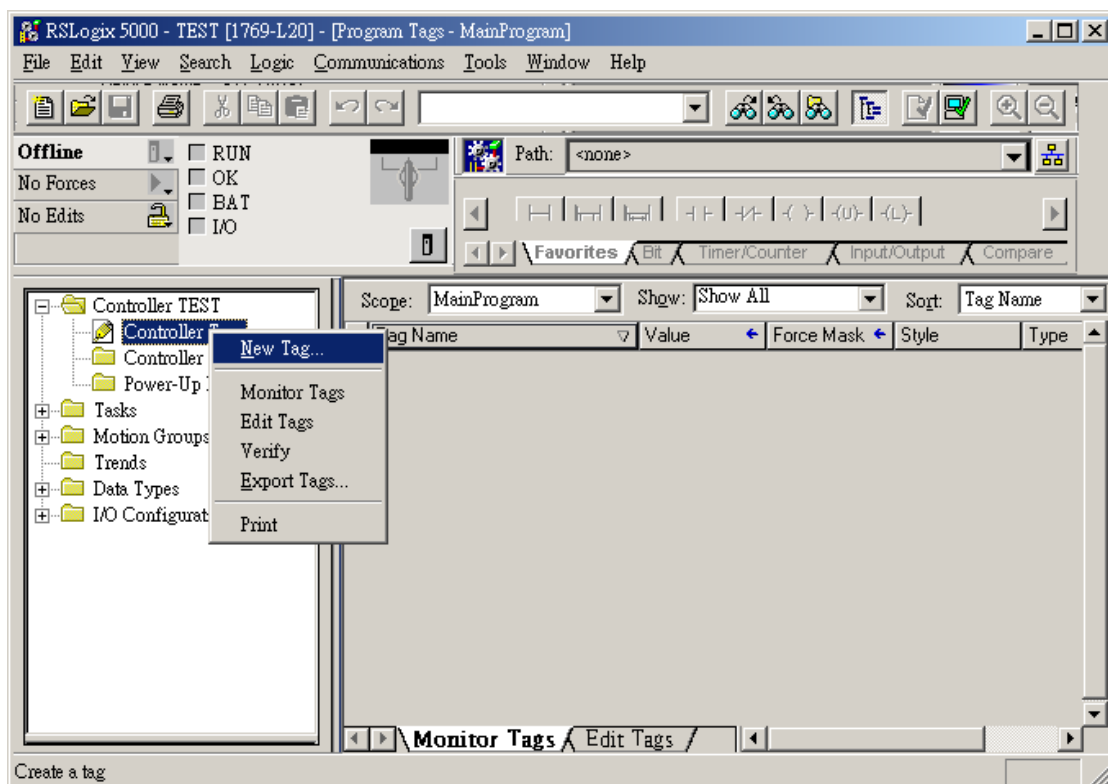
ControlLogix, CompactLogix CPU CH0 setting:

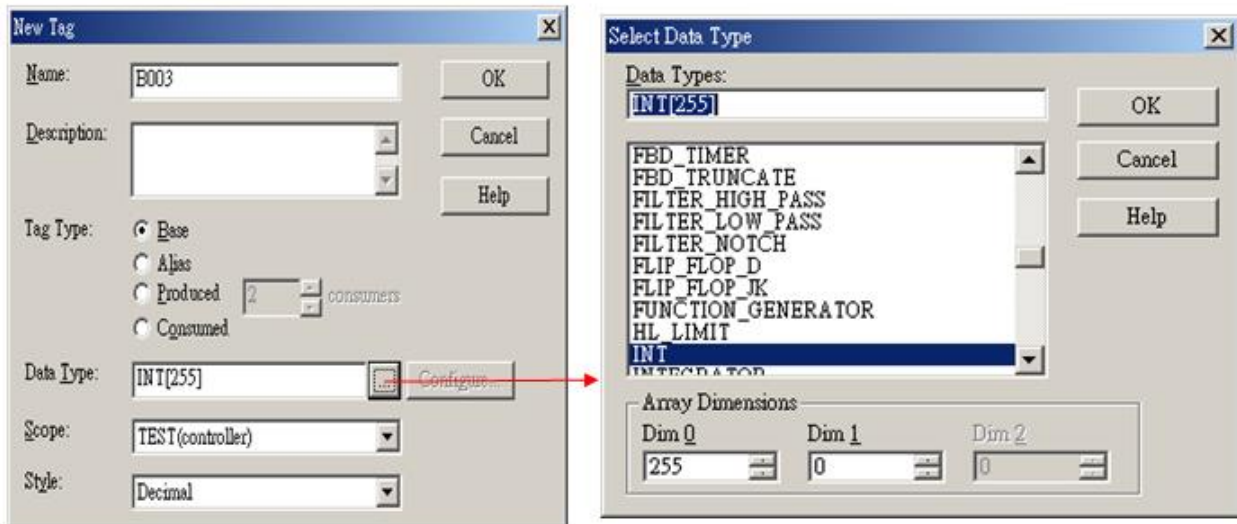


Create a Tag:

The name format must be 4 chars. For example: B003, T004, C005, N007, and F008.

Two or three chars are not available. For example: B03 or B3.





Device Address:

Bit/Word	Device type	Format	Range	Memo
B	B_BOOL	FFFDDDD	0 ~ 25525515	Bit data file
B	N_BOOL	FFFDDDD	0 ~ 25525515	Integer data file bit level (N7, 10 ~ 255)
DW	Tx.ACC	FFFDDDD	0 ~ 255255	Timer Accumulator Value (T4, T10 ~ 255)
DW	Tx.PRE	FFFDDDD	0 ~ 255255	Timer Preset Value (T4, T10 ~ 255)
DW	Nx_INT	FFFDDDD	0 ~ 255255	Integer data file (N7, 10 ~ 255)
W	Bx_INT	FFFDDDD	0 ~ 255255	Bit data file word level
DW	Cx.ACC	FFFDDDD	0 ~ 255255	Counter Accumulator Value (C5, C10 ~ 255)
DW	Cx.PRE	FFFDDDD	0 ~ 255255	Counter Preset Value (C5, C10 ~ 255)
W	F8_REAL	DDD	0 ~ 255	Floating point data file (F8)
W	Fx_REAL	FFFDDDD	0 ~ 255255	Floating point data file (F008, F010 ~ F255)

Wiring Diagram:

Diagram 1

cMT Series	<i>cMT3151</i>
eMT Series	<i>eMT3070 / eMT3105 / eMT3120 / eMT3150</i>
MT-iE	<i>MT8073iE / MT8102iE</i>
MT-XE	<i>MT8092XE</i>
MT-iP	<i>MT6103iP</i>

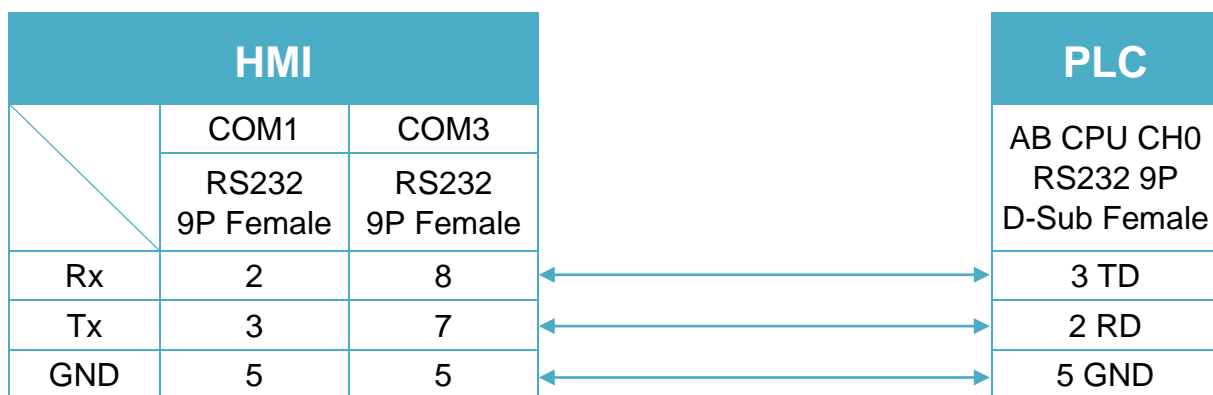


Diagram 2

cMT Series	<i>cMT-SVR</i>
mTV	<i>mTV</i>
MT-iE	<i>MT8070iE / MT6070iE / MT8100iE / MT8121iE / MT8150iE / MT8071iE / MT6071iE / MT8072iE / MT6072iE / MT8073iE / MT8101iE / MT8102iE / MT8103iE</i>
MT-XE	<i>MT8121XE / MT8150XE / MT8090XE</i>

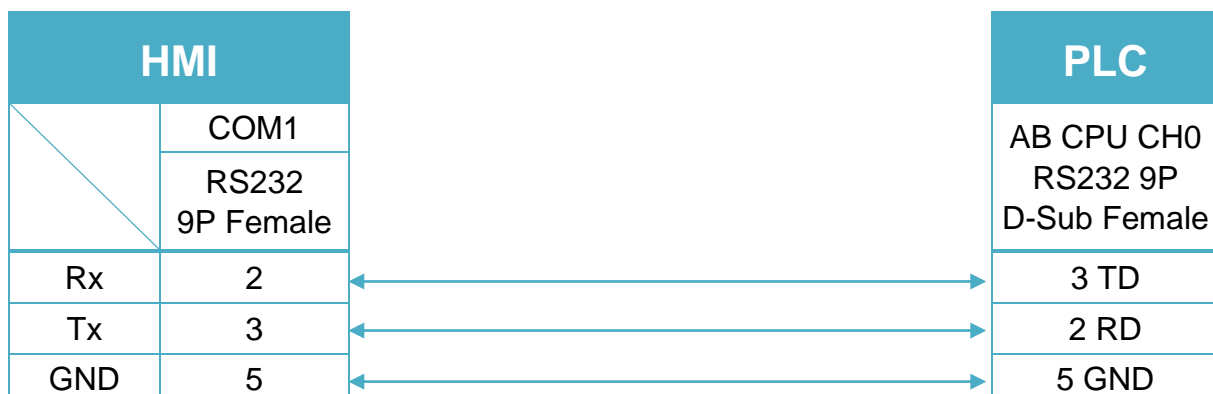
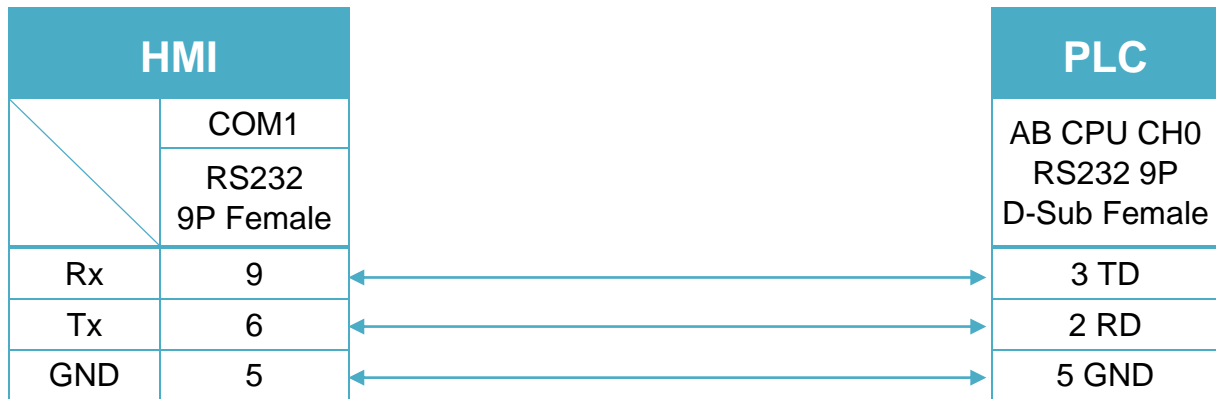


Diagram 3

MT-iE
MT8050iE
MT-iP
MT6051iP / MT6071iP / MT8071iP


Rockwell DF1

Supported Series: Rockwell MicroLogix 1000, 1100, 1200, 1400, 1500, SLC 5/01, 5/02, 5/03, 5/04, 5/05.

Website: <http://www.ab.com>

Note: Allen-Bradley DF1 driver uses CRC checksum.

HMI Setting:

Parameters	Recommended	Options	Notes
PLC type	Rockwell DF1		
PLC I/F	RS232		
Baud rate	19200	9600, 19200, 38400	
Data bits	8	8	
Parity	None	Even, Odd, None	
Stop bits	1	1	
HMI sta. no.	0		
PLC sta. no.	1	1-31	

PLC Setting:

Communication mode	DF1 Full Duplex protocol 19200, None, 8, 1 (default) Error Check: CRC
---------------------------	--

Device Address:

Bit/Wor	Device type	Format	Range	Memo
B	I1	DDDdd	0 ~ 25515	Input (I)
B	O0	DDDdd	0 ~ 25515	Output (O)
B	B3	DDDdd	0 ~ 25515	Bit data file (B3)
B	B10 ~ 13	DDDdd	0 ~ 25515	Bit data file (B10 ~ 13)
B	S_Bit	DDDdd	0 ~ 25515	Status (S) bit level
B	Bfn	FFFDDDDdd	0 ~ 25525515	Bit data file (B3, 10 ~ 254)
B	NfnBit	FFFDDDDdd	0 ~ 25525515	Integer data file bit level (N7, 10 ~ 254)
W	T4SV	DDD	0 ~ 255	Timer Preset Value (T4)
W	T4PV	DDD	0 ~ 255	Timer Accumulator Value (T4)
W	C5SV	DDD	0 ~ 255	Counter Preset Value (C5)

Bit/Wor	Device type	Format	Range	Memo
W	C5PV	DDD	0 ~ 255	Counter Accumulator Value
W	TfnSV	FFFDDD	0 ~ 255255	Timer Preset Value
W	TfnPV	FFFDDD	0 ~ 255255	Timer Accumulator Value
W	CfnSV	FFFDDD	0 ~ 255255	Counter Preset Value
W	CfnPV	FFFDDD	0 ~ 255255	Counter Accumulator Value
W	N7	DDD	0 ~ 255	Integer data file (N7)
W	N10 ~ 15	DDD	0 ~ 255	Integer data file (N10 ~ 15)
W	Nfn	FFFDDD	0 ~ 255255	Integer data file (N7,10 ~ 254)
W	S	DDD	0 ~ 255	Status (S)
W	F8	DDD	0 ~ 255	Floating point data file (F8)
W	Ffn	FFFDDD	0 ~ 255255	
W	Lfn	FFFDDD	0 ~ 255255	
String	STfn	DDD.DDD.DD	0 ~ 255.255.40	File no.Element no.Data no.

Wiring Diagram:

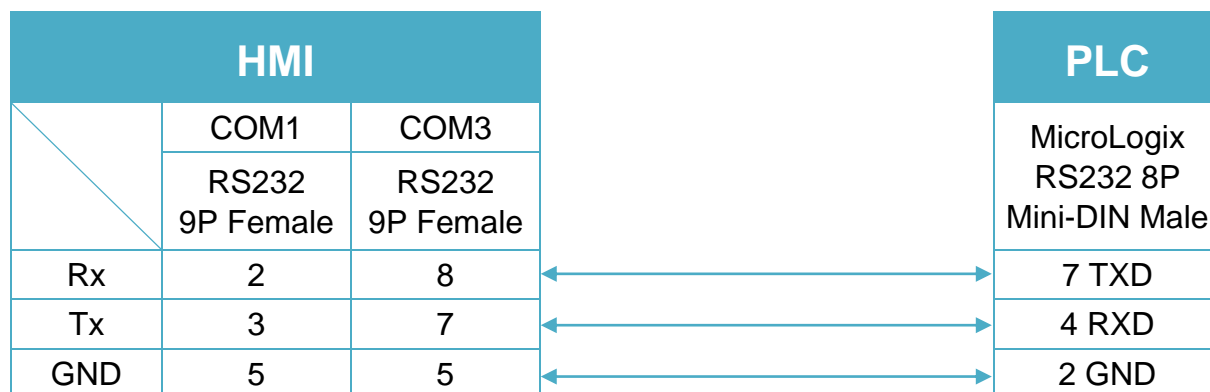
The following is the view from the soldering point of a cable.

9P D-Sub to 8P Mini-DIN: MicroLogix 1000, 1100, 1200, 1400, 1500 (Diagram 1 ~ Diagram 3)



Diagram 1

cMT Series	<i>cMT3151</i>
eMT Series	<i>eMT3070 / eMT3105 / eMT3120 / eMT3150</i>
MT-iE	<i>MT8073iE / MT8102iE</i>
MT-XE	<i>MT8092XE</i>
MT-iP	<i>MT6103iP</i>


Diagram 2

cMT Series	<i>cMT-SVR</i>
mTV	<i>mTV</i>
MT-iE	<i>MT8070iE / MT6070iE / MT8100iE / MT8121iE / MT8150iE / MT8071iE / MT6071iE / MT8072iE / MT6072iE / MT8073iE / MT8101iE / MT8102iE / MT8103iE</i>
MT-XE	<i>MT8121XE / MT8150XE / MT8090XE</i>

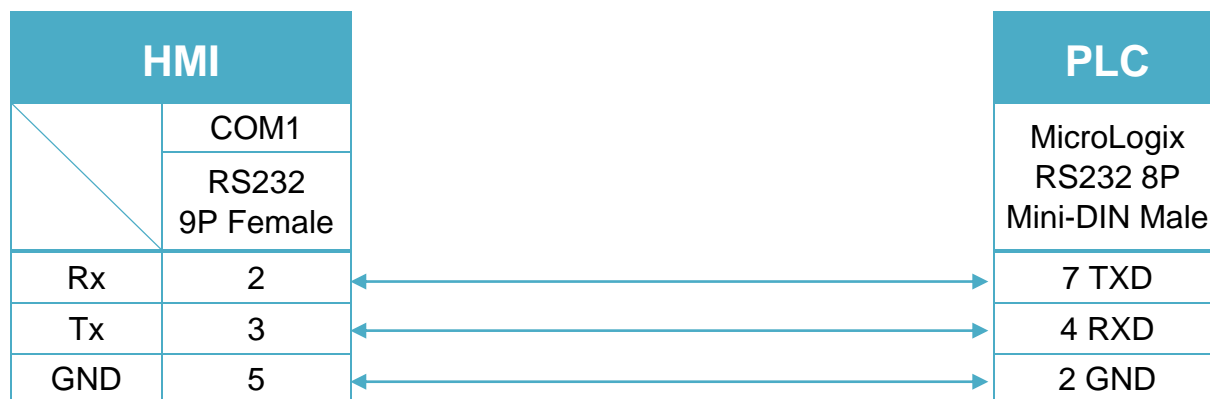
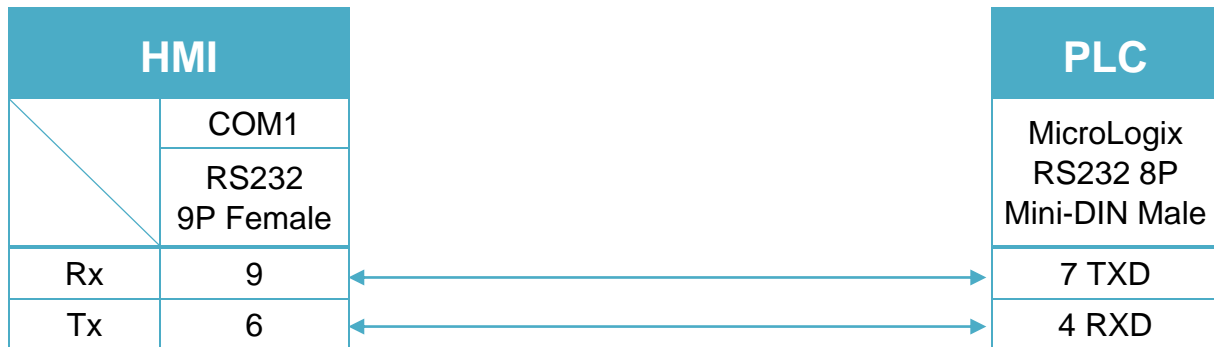


Diagram 3

MT-iE	MT8050iE
MT-iP	MT6051iP / MT6071iP / MT8071iP



9P D-Sub to 9P D-Sub: SLC5/03, 04, 05 CH0 (Diagram 4 ~ Diagram 6)

Diagram 4

cMT Series	cMT3151
eMT Series	eMT3070 / eMT3105 / eMT3120 / eMT3150
MT-iE	MT8073iE / MT8102iE
MT-XE	MT8092XE
MT-iP	MT6103iP

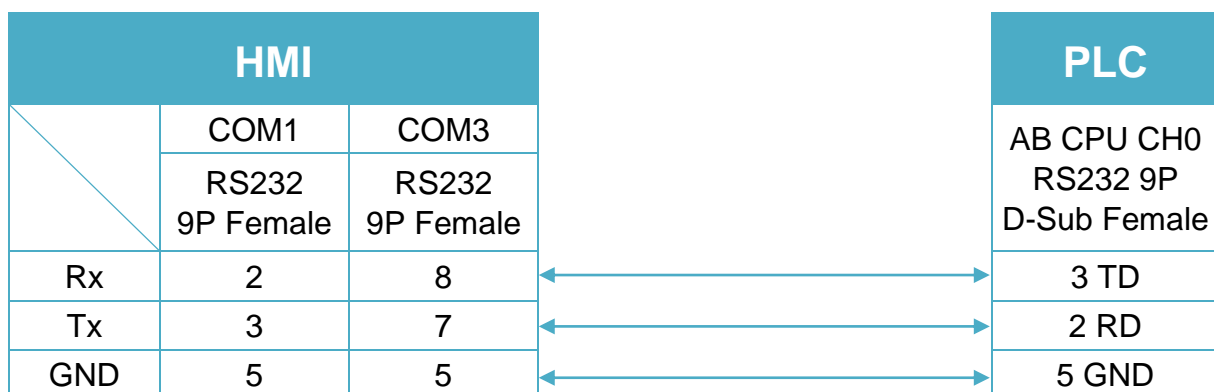


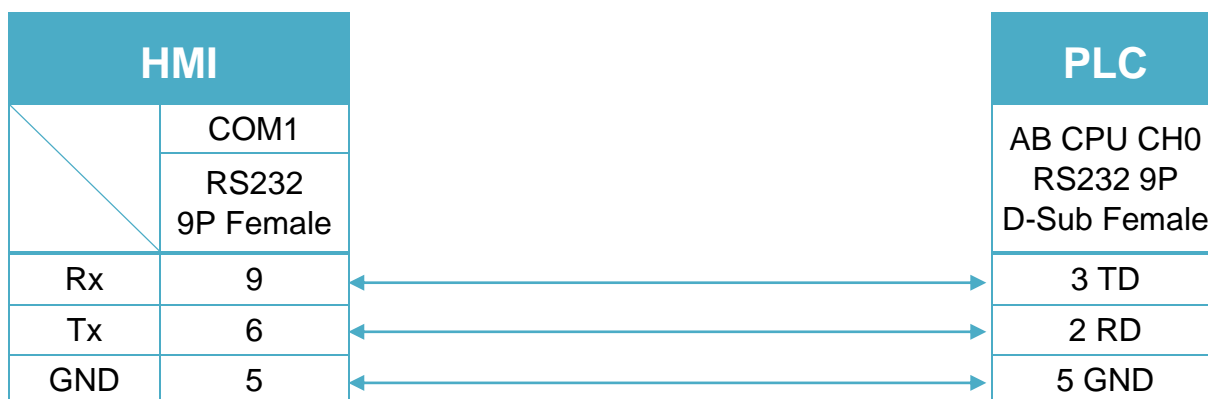
Diagram 5

cMT Series	cMT-SVR
mTV	mTV
MT-iE	MT8070iE / MT6070iE / MT8100iE / MT8121iE / MT8150iE / MT8071iE / MT6071iE / MT8072iE / MT6072iE / MT8073iE / MT8101iE / MT8102iE / MT8103iE
MT-XE	MT8121XE / MT8150XE / MT8090XE



Diagram 6

MT-iE	MT8050iE
MT-iP	MT6051iP / MT6071iP / MT8071iP



Rockwell DF1 (BCC)

Supported Series: Rockwell MicroLogix 1000, 1100, 1200, 1400, 1500, SLC 5/01, 5/02, 5/03, 5/04, 5/05.

Website: <http://www.ab.com>

Note: Allen-Bradley DF1 (BCC) and Allen-Bradley DF1 are the same; the only difference is the use of BCC checksum.

HMI Setting:

Parameters	Recommended	Options	Notes
PLC type	Rockwell DF1 (BCC)		
PLC I/F	RS232		
Baud rate	19200	9600, 19200, 38400	
Data bits	8	8	
Parity	None	Even, Odd, None	
Stop bits	1	1	
HMI sta. no.	0		
PLC sta. no.	1	1-31	

PLC Setting:

Communication mode	DF1 Full Duplex protocol 19200, None, 8, 1 (default) Error Check: BCC
---------------------------	--

Device Address:

Bit/Word	Device type	Format	Range	Memo
B	I1	DDDdd	0 ~ 25515	Input (I)
B	O0	DDDdd	0 ~ 25515	Output (O)
B	B3	DDDdd	0 ~ 25515	Bit data file (B3)
B	B10 ~ 13	DDDdd	0 ~ 25515	Bit data file (B10 ~ 13)
B	S_Bit	DDDdd	0 ~ 25515	Status (S) bit level
B	Bfn	FFFDDDDdd	0 ~ 25525515	Bit data file (B3, 10 ~ 254)
B	NfnBit	FFFDDDDdd	0 ~ 25525515	Integer data file bit level (N7, 10 ~ 254)
W	T4SV	DDD	0 ~ 255	Timer Preset Value (T4)
W	T4PV	DDD	0 ~ 255	Timer Accumulator Value (T4)
W	C5SV	DDD	0 ~ 255	Counter Preset Value (C5)

Bit/Word	Device type	Format	Range	Memo
W	C5PV	DDD	0 ~ 255	Counter Accumulator Value (C5)
W	TfnSV	FFFDDD	0 ~ 255255	Timer Preset Value
W	TfnPV	FFFDDD	0 ~ 255255	Timer Accumulator Value
W	CfnSV	FFFDDD	0 ~ 255255	Counter Preset Value
W	CfnPV	FFFDDD	0 ~ 255255	Counter Accumulator Value
W	N7	DDD	0 ~ 255	Integer data file (N7)
W	N10~15	DDD	0 ~ 255	Integer data file (N10 ~ 15)
W	Nfn	FFFDDD	0 ~ 255255	Integer data file (N7, 10 ~ 254)
W	S	DDD	0 ~ 255	Status (S)
W	F8	DDD	0 ~ 255	Floating point data file (F8)
W	Ffn	FFFDDD	0 ~ 255255	
W	Lfn	FFFDDD	0 ~ 255255	
W	STfn	DDD.DDD.DD	0 ~ 255.255.40	

Wiring Diagram:

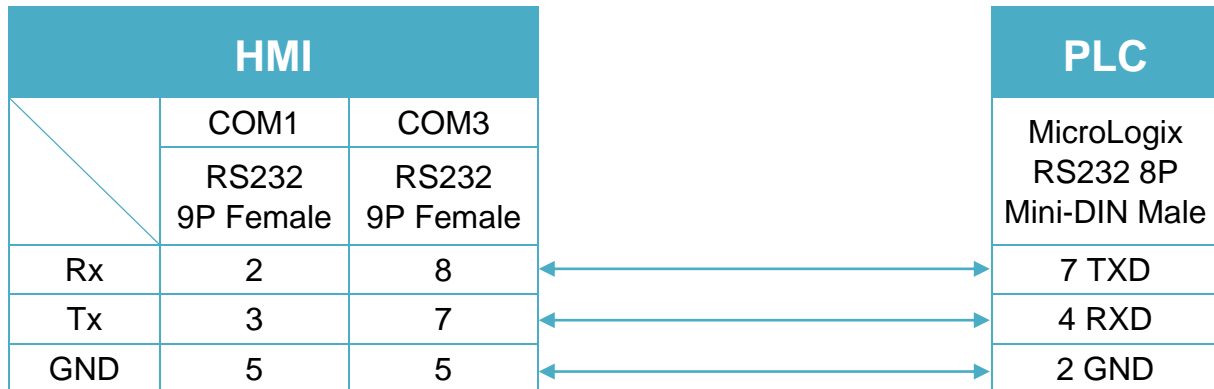
The following is the view from the soldering point of a cable.

9P D-Sub to 8P Mini-DIN: MicroLogix 1000, 1100, 1200, 1500 (Diagram 1 ~ Diagram 3)



Diagram 1

cMT Series	<i>cMT3151</i>
eMT Series	<i>eMT3070 / eMT3105 / eMT3120 / eMT3150</i>
MT-iE	<i>MT8073iE / MT8102iE</i>
MT-XE	<i>MT8092XE</i>
MT-iP	<i>MT6103iP</i>


Diagram 2

cMT Series	cMT-SVR
mTV	mTV
MT-iE	MT8070iE / MT6070iE / MT8100iE / MT8121iE / MT8150iE / MT8071iE / MT6071iE / MT8072iE / MT6072iE / MT8073iE / MT8101iE / MT8102iE / MT8103iE
MT-XE	MT8121XE / MT8150XE / MT8090XE

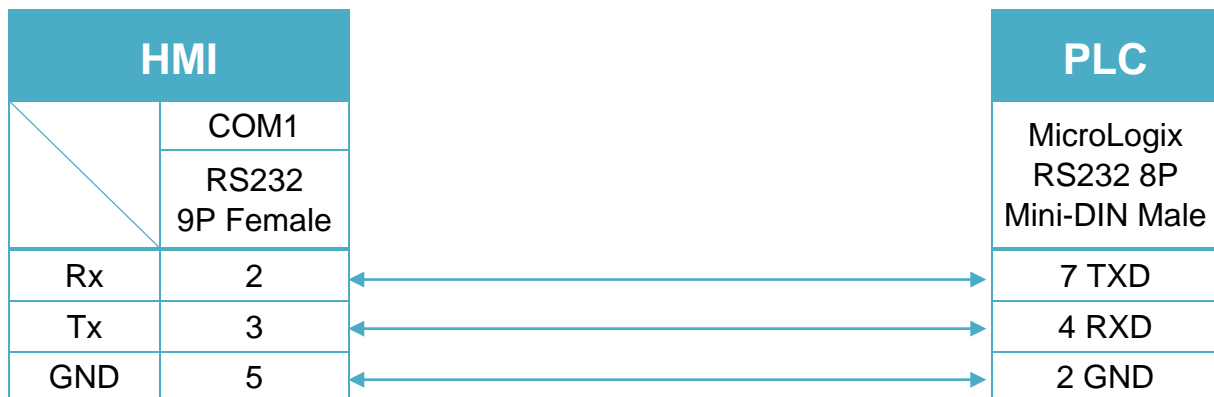


Diagram 3

MT-iE	<i>MT8050iE</i>
MT-iP	<i>MT6051iP / MT6071iP / MT8071iP</i>



9P D-Sub to 9P D-Sub: SLC5/03, 04, 05 CH0 (Diagram 4 ~ Diagram 6)

Diagram 4

cMT Series	<i>cMT3151</i>
eMT Series	<i>eMT3070 / eMT3105 / eMT3120 / eMT3150</i>
MT-iE	<i>MT8073iE / MT8102iE</i>
MT-XE	<i>MT8092XE</i>
MT-iP	<i>MT6103iP</i>

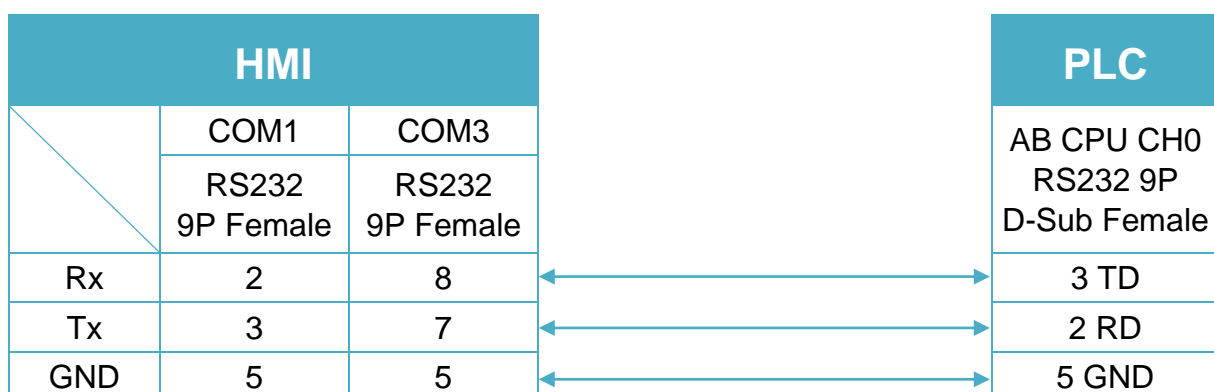


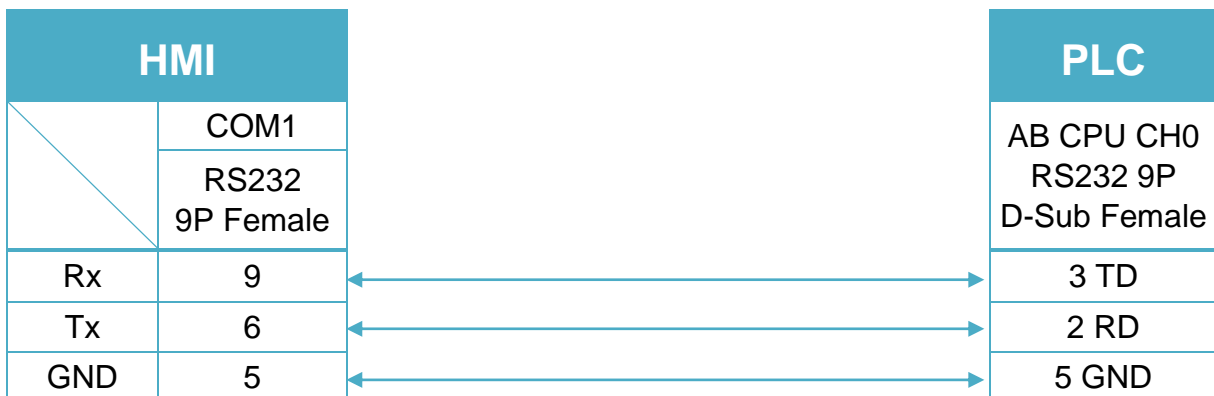
Diagram 5

cMT Series	cMT-SVR
mTV	mTV
MT-iE	MT8070iE / MT6070iE / MT8100iE / MT8121iE / MT8150iE / MT8071iE / MT6071iE / MT8072iE / MT6072iE / MT8073iE / MT8101iE / MT8102iE / MT8103iE
MT-XE	MT8121XE / MT8150XE / MT8090XE



Diagram 6

MT-iE	MT8050iE
MT-iP	MT6051iP / MT6071iP / MT8071iP



Rockwell DH485

Supported Series: Rockwell MicroLogix 1000, 1100, 1200, 1400, 1500, SLC 5/01, 5/02, 5/03, 5/04, 5/05.

Website: <http://www.ab.com>

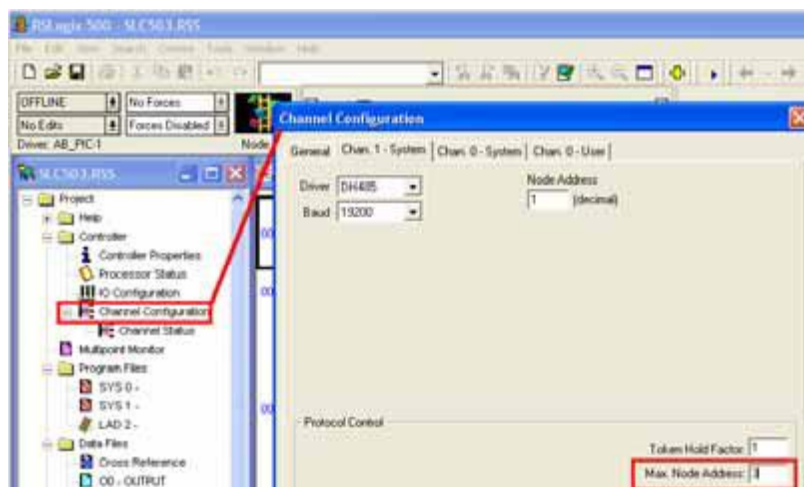
HMI Setting:

Parameters	Recommended	Options	Notes
PLC type	Rockwell DH485		
PLC I/F	RS485 2W	RS232	
Baud rate	19200	9600, 19200	
Data bits	8		
Parity	Even		
Stop bits	1		
HMI sta. no.	0	2	
PLC sta. no.	1	1-31	

Online simulation	YES
Extend address mode	NO

PLC Setting:

Communication mode	DH485 protocol 19200 (default) Set the Max. Node Address to the number of PLCs in use.
--------------------	---



Device Address:

Bit/Word	Device	Format	Range	Memo
B	I1	DDDdd	0 ~ 25515	Input (I)
B	O0	DDDdd	0 ~ 25515	Output (O)
B	B3	DDDdd	0 ~ 25515	Bit data file (B3)
B	B10 ~ 13	DDDdd	0 ~ 25515	Bit data file (B10 ~ 13)
B	Bfn	FFFDDDDdd	0 ~ 25525515	Bit data file (B3, 10 ~ 254)
B	NfnBit	FFFDDDDdd	0 ~ 25525515	Integer data file bit level (N7,10 ~ 254)
B	S_Bit	DDDdd	0 ~ 25515	Status file
W	T4SV	DDD	0 ~ 255	Timer Preset Value (T4)
W	T4PV	DDD	0 ~ 255	Timer Accumulator Value (T4)
W	C5SV	DDD	0 ~ 255	Counter Preset Value (C5)
W	C5PV	DDD	0 ~ 255	Counter Accumulator Value (C5)
W	TfnSV	FFFDDD	0 ~ 255255	Timer Preset Value
W	TfnPV	FFFDDD	0 ~ 255255	Timer Accumulator Value
W	CfnSV	FFFDDD	0 ~ 255255	Counter Preset Value
W	CfnPV	FFFDDD	0 ~ 255255	Counter Accumulator Value
W	F8	DDD	0 ~ 255	Floating point data file (F8)
W	N7	DDD	0 ~ 255	Integer data file (N7)
W	N10 ~ 15	DDD	0 ~ 255	Integer data file (N10 ~ 15)
W	Nfn	FFFDDD	0 ~ 255255	Integer data file (N7,10 ~ 254)
W	S	DDD	0 ~ 255	Status file

Wiring Diagram:

RS-485: SLC500 Fixed type, SLC5/01, 02, 03 CH1. (Diagram 1 ~ Diagram 6)

HMI can't connect to 1747-AIC peripheral port.

Diagram 1

cMT Series

cMT3151

eMT Series

eMT3070 / eMT3105 / eMT3120 / eMT3150

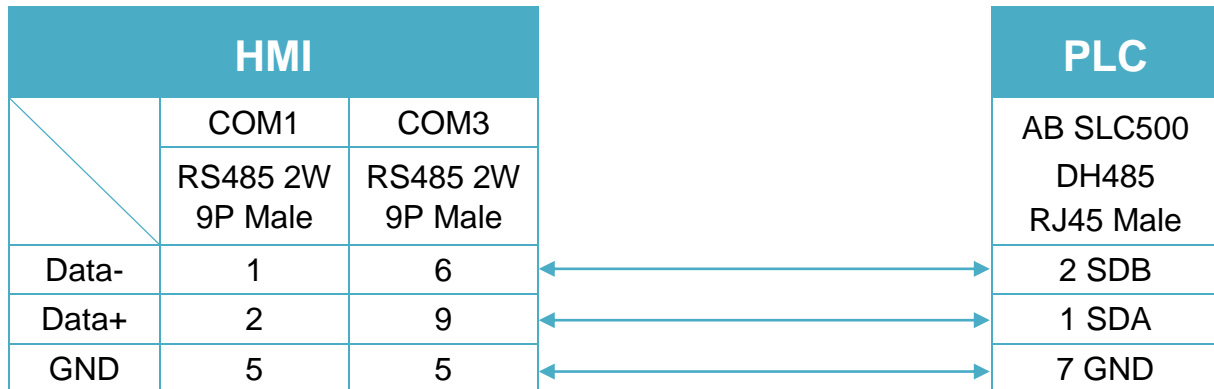
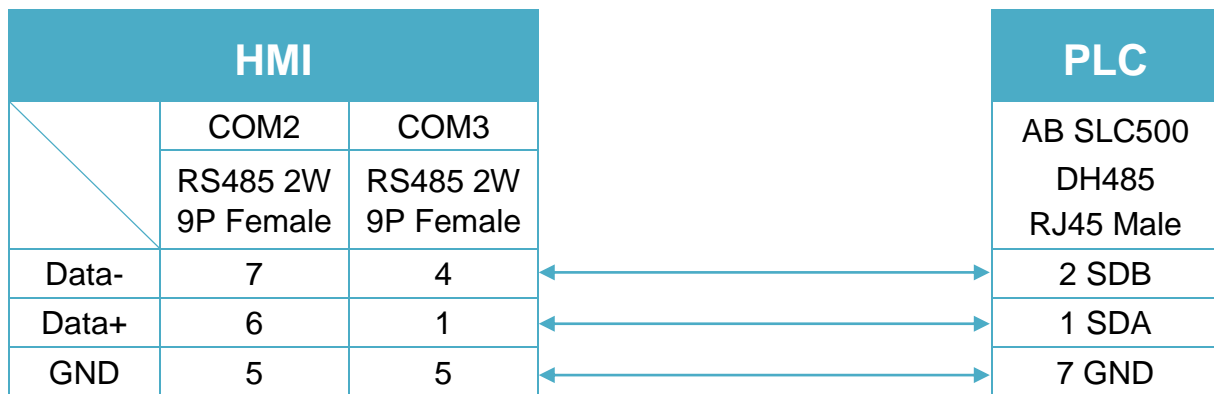
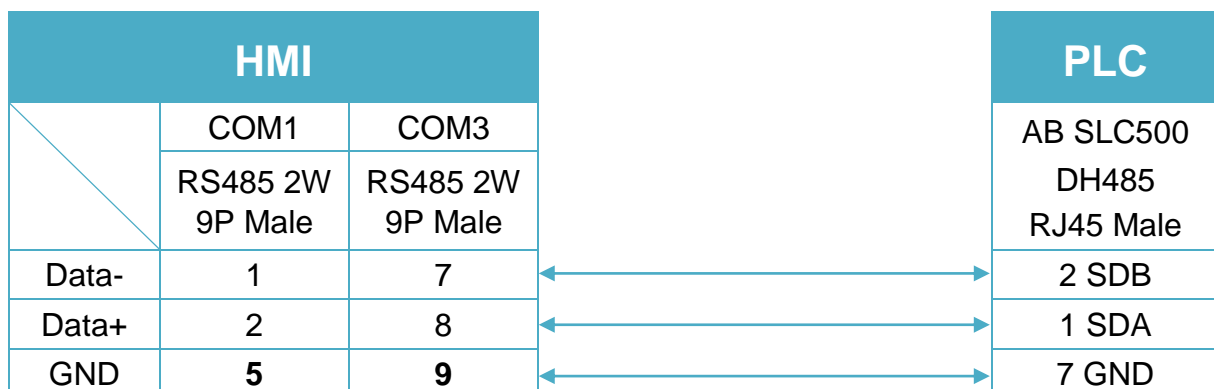

Diagram 2
cMT Series *cMT-SVR*
mTV *mTV*

Diagram 3
MT-iE *MT8070iE / MT6070iE / MT8100iE / MT8121iE / MT8150iE*
MT-XE *MT8121XE / MT8150XE*


Diagram 4

MT-iE	<i>MT8071iE / MT6071iE / MT8072iE / MT6072iE / MT8073iE / MT8101iE / MT8102iE / MT8103iE</i>
MT-XE	<i>MT8090XE / MT8092XE</i>
MT-iP	<i>MT6103iP</i>

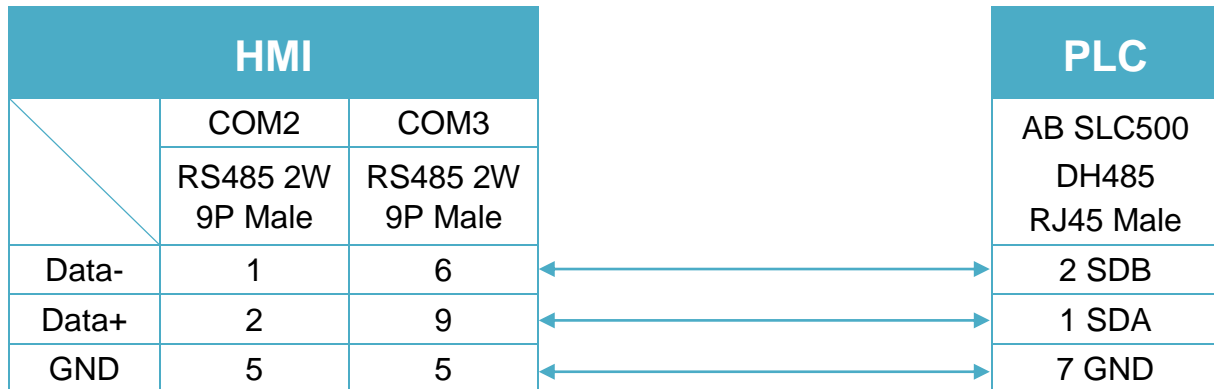


Diagram 5

MT-iE	<i>MT8050iE</i>
MT-iP	<i>MT6051iP</i>

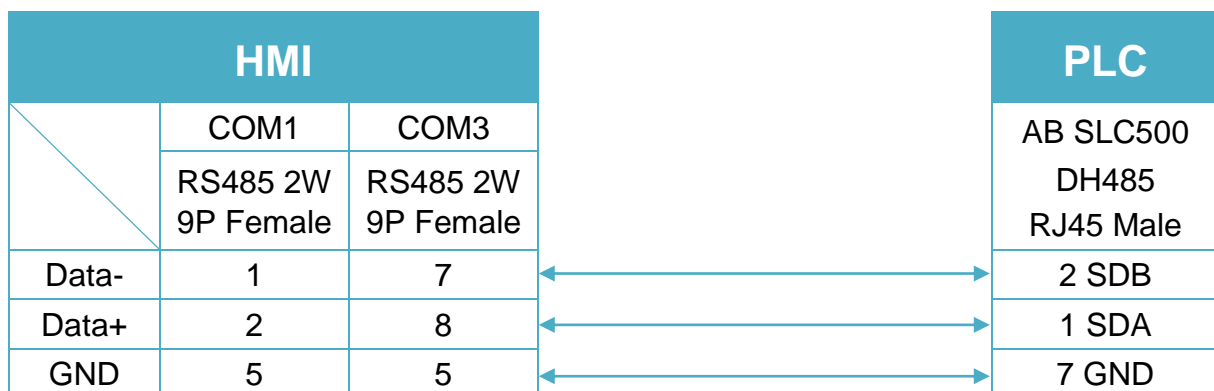


Diagram 6

MT-iP
MT6071iP / MT8071iP


The following is the view from the soldering point of a cable.

9P D-Sub to 8P Mini-DIN: MicroLogix 1000, 1100, 1200, and 1500 must set DH485 protocol. (Diagram 7 ~ Diagram 9)



Diagram 7

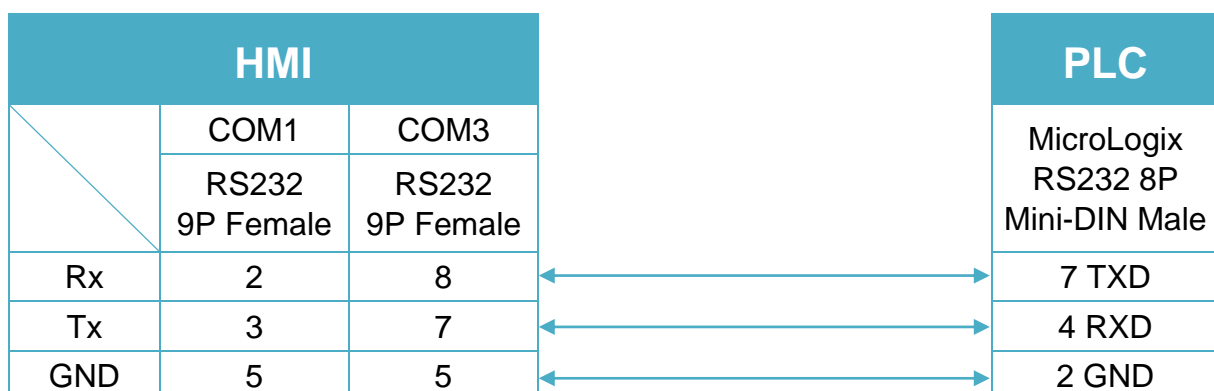
cMT Series
cMT3151
eMT Series
eMT3070 / eMT3105 / eMT3120 / eMT3150
MT-iE
MT8073iE / MT8102iE
MT-XE
MT8092XE
MT-iP
MT6103iP


Diagram 8

cMT Series	cMT-SVR
mTV	mTV
MT-iE	MT8070iE / MT6070iE / MT8100iE / MT8121iE / MT8150iE / MT8071iE / MT6071iE / MT8072iE / MT6072iE / MT8073iE / MT8101iE / MT8102iE / MT8103iE
MT-XE	MT8121XE / MT8150XE / MT8090XE

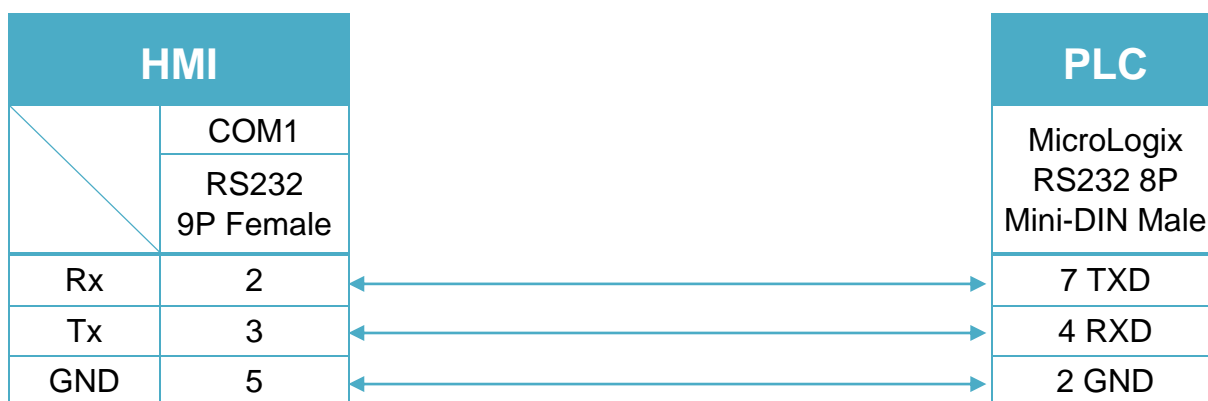
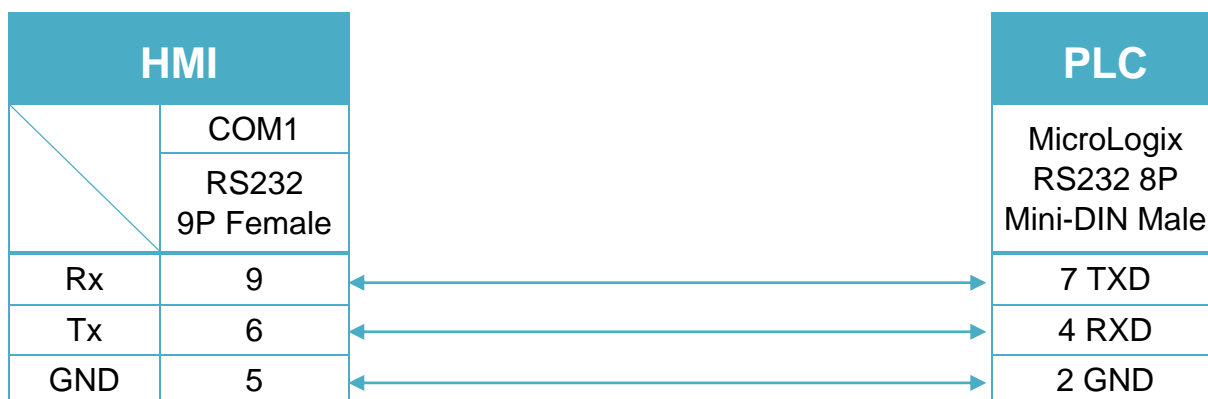


Diagram 9

MT-iE	MT8050iE
MT-iP	MT6051iP / MT6071iP / MT8071iP



9P D-Sub to 9P D-Sub: SLC5/03, 04, 05 CH0 must set DH485 protocol. (Diagram 10 ~ Diagram 12)

Diagram 10

cMT Series	<i>cMT3151</i>
eMT Series	<i>eMT3070 / eMT3105 / eMT3120 / eMT3150</i>
MT-iE	<i>MT8073iE / MT8102iE</i>
MT-XE	<i>MT8092XE</i>
MT-iP	<i>MT6103iP</i>

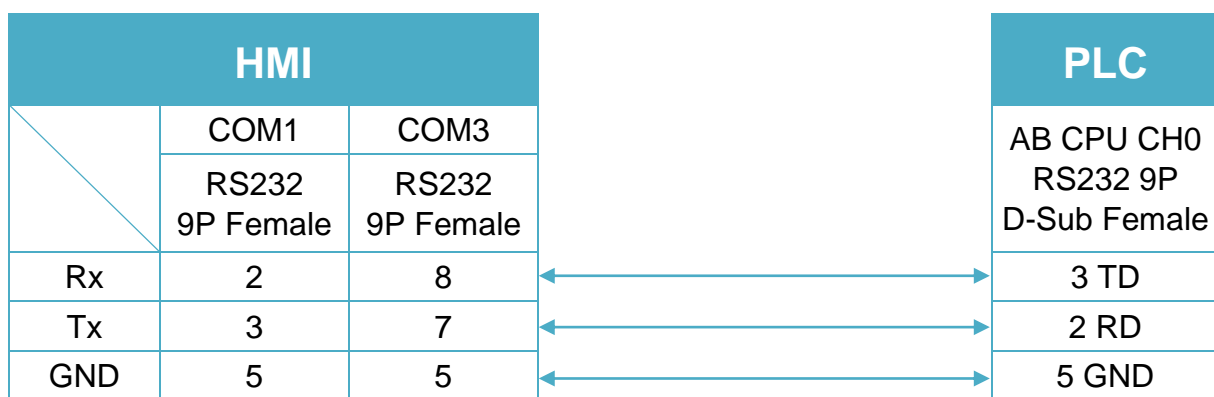


Diagram 11

cMT Series	<i>cMT-SVR</i>
mTV	<i>mTV</i>
MT-iE	<i>MT8070iE / MT6070iE / MT8100iE / MT8121iE / MT8150iE / MT8071iE / MT6071iE / MT8072iE / MT6072iE / MT8073iE / MT8101iE / MT8102iE / MT8103iE</i>
MT-XE	<i>MT8121XE / MT8150XE / MT8090XE</i>

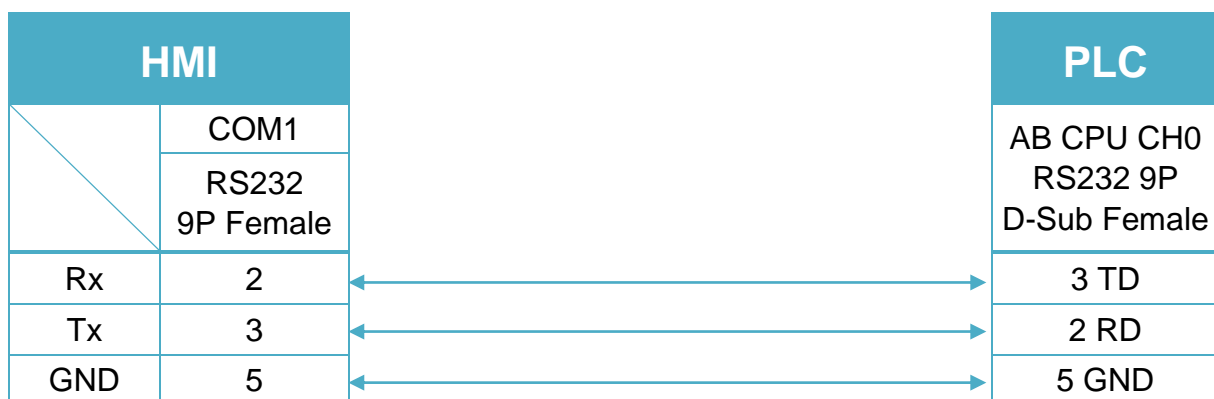


Diagram 12
MT-iE
MT8050iE
MT-iP
MT6051iP / MT6071iP / MT8071iP


Rockwell EtherNet/IP (CompactLogix)

Supported Series: Rockwell ControlLogix, CompactLogix, FlexLogix Ethernet.

Website: <http://www.ab.com>

HMI Setting:

Parameters	Recommended	Options	Notes
PLC type	Rockwell EtherNet/IP (CompactLogix)		
PLC I/F	Ethernet		
Port no.	44818		
PLC sta. no.	1		

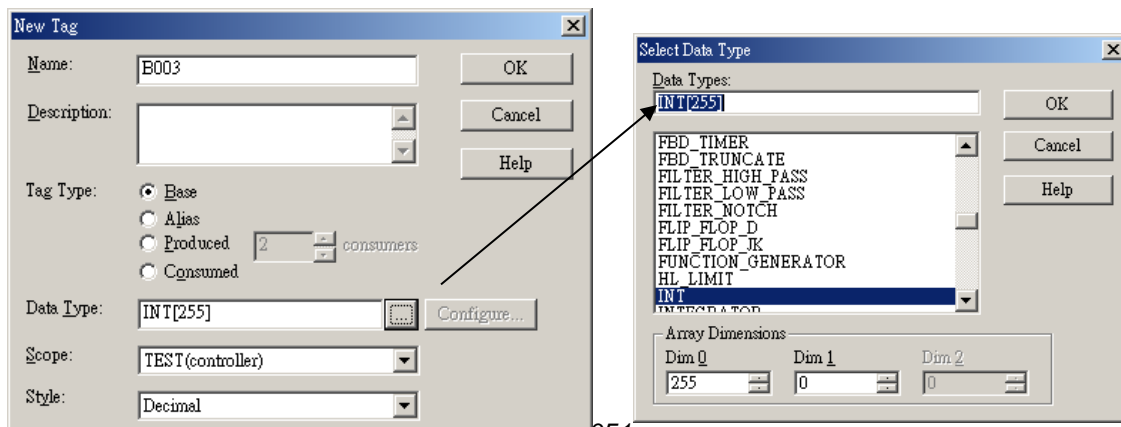
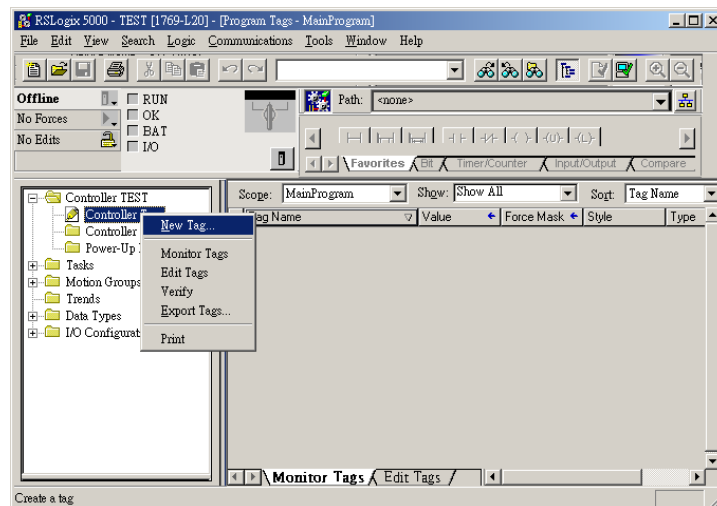
PLC Setting:

RSLogix 5000 setting

Create a Tag:

The name format must be 4 chars. For example: B003, T004, C005, N007, and F008.

Two or three chars are not available. For example: B03 or B3.



Device Address:

Bit/Word	Device	Format	Range	Memo
B	Bx_BOOL	FFFDDDDdd	0 ~ 25525515	Bit data file
B	Nx_BOOL	FFFDDDDdd	0 ~ 25525515	Integer data file bit level (N7, 10 ~ 99)
W	Bx_INT	FFFDDD	0 ~ 255255	Bit data file word level
W	Nx_INT	FFFDDD	0 ~ 255255	Integer data file (N7, 10 ~ 99)
DW (F)	F8_REAL	DDD	0 ~ 255	Floating point data file (F8)
DW (F)	Fx_REAL	FFFDDD	0 ~ 255255	Floating point data file (F8)
DW	Cx.ACC	FFFDDD	0 ~ 255255	Counter Accumulator Value (C5, C10 ~ 255)
DW	Cx.PRE	FFFDDD	0 ~ 255255	Counter Preset Value (C5, C10 ~ 255)
DW	Tx.ACC	FFFDDD	0 ~ 255255	Timer Accumulator Value (T4, T10 ~ 255)
DW	Tx.PRE	FFFDDD	0 ~ 255255	Timer Preset Value (T4, T10 ~ 255)
DW	Lx.DINT	FFFDDD	0 ~ 255255	

Wiring Diagram:

Diagram 1

Ethernet cable:



Rockwell EtherNet/IP (CompactLogix) – Free Tag Names

Supported Series: Rockwell CompactLogix, FlexLogix Ethernet

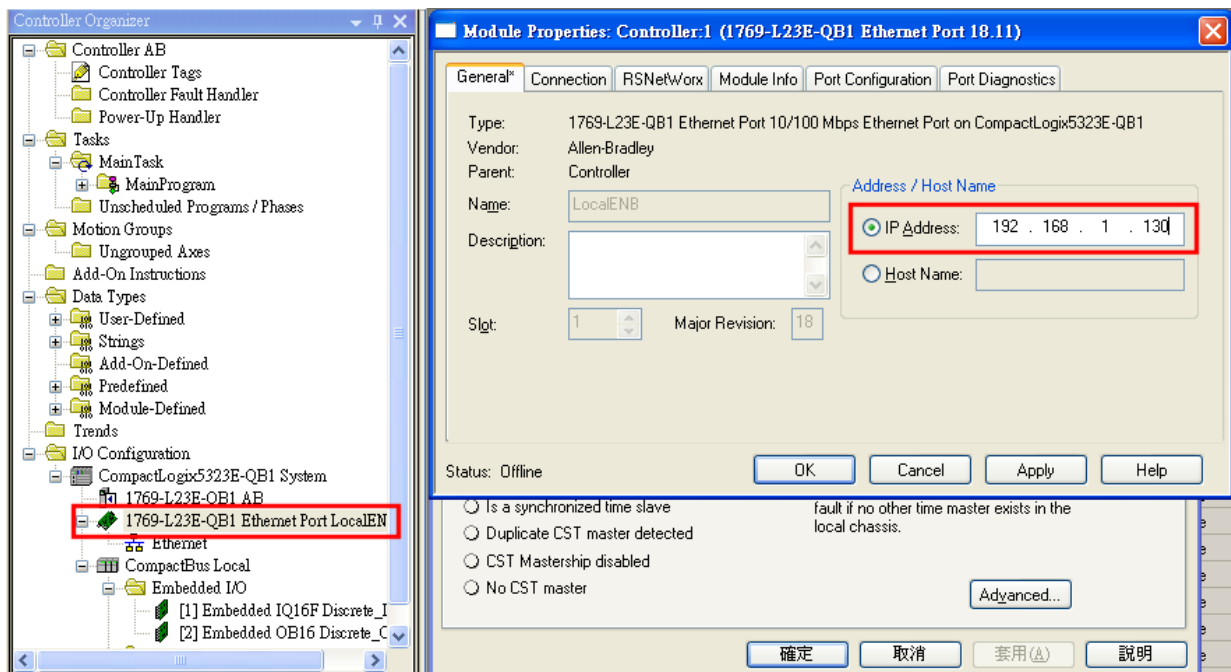
Website: <http://www.ab.com>

HMI Setting:

Parameters	Recommended	Options	Notes
PLC type	Rockwell EtherNet/IP (CompactLogix) – Free Tag Names		
PLC I/F	Ethernet		
Port no.	44818		
PLC sta. no.	1		

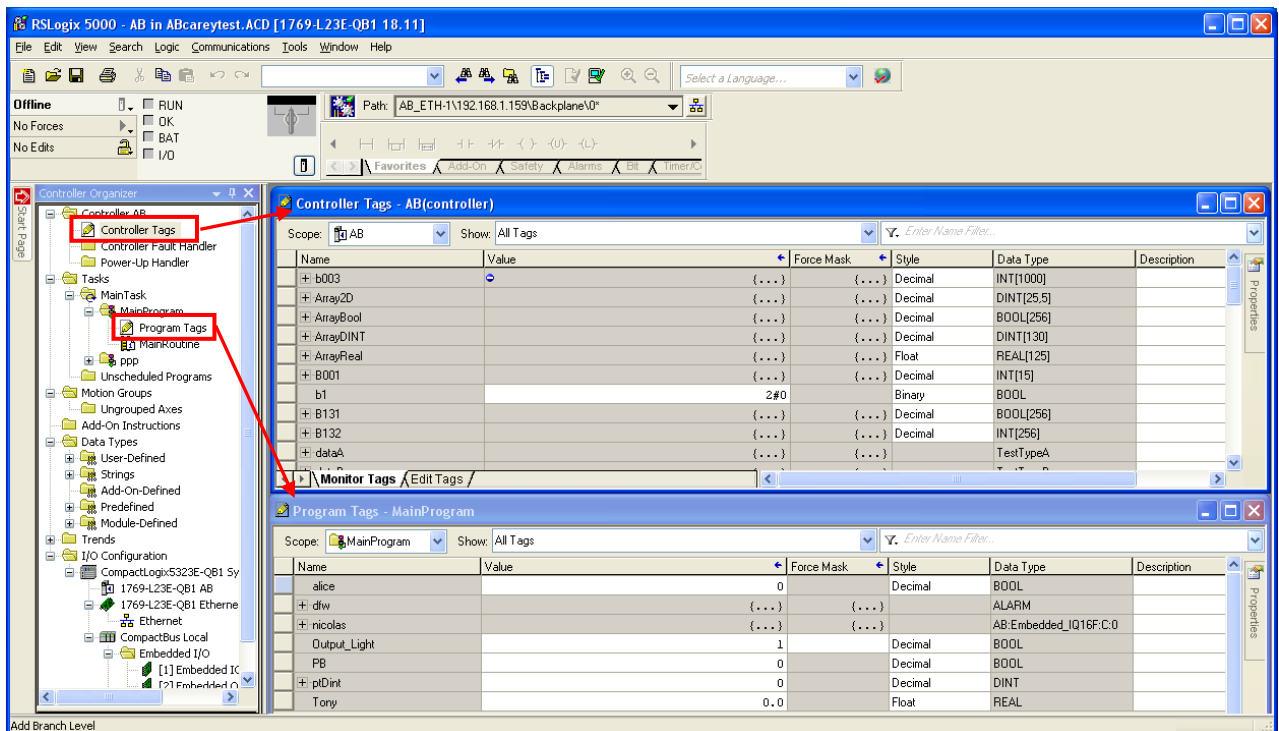
PLC Setting:

- Set PLC IP address.

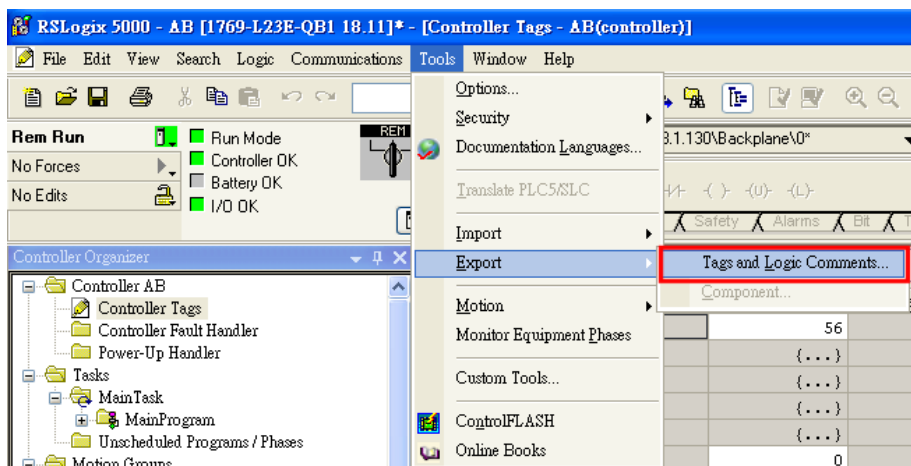


The screenshot shows the Rockwell Studio 5000 interface. On the left is the Controller Organizer tree, where the module '1769-L23E-QB1 Ethernet Port LocalEN' is selected and highlighted with a red box. On the right is the 'Module Properties' dialog box for 'Controller:1 (1769-L23E-QB1 Ethernet Port 18.11)'. The 'General' tab is active, and the 'Address / Host Name' section is highlighted with a red box. The 'IP Address' radio button is selected, and the address '192.168.1.130' is entered in the text field. Other fields include 'Name: LocalENB', 'Description:', 'Slot: 1', and 'Major Revision: 18'. The status is 'Offline'. At the bottom, there are buttons for 'OK', 'Cancel', 'Apply', and 'Help', along with Japanese equivalents '確定', '取消', '套用(A)', and '説明'.

2. Create new tags (Controller Tags and Program Tags supported).



3. Export Tag data to CSV file. ([Tools] » [Export] » [Tags and Logic Comments])



Note: The separator character in CSV file must be a comma “,” otherwise the file is invalid.

The directory of changing system settings: [Control Panel] » [Date, Time, Language, and Regional Options] » [Change the format of numbers, dates, and times] » [Customize] » [List separator]. Please select “,” and export CSV file after setting.

TYPE	SCOPE	NAME	DESCRIPTION	DATATYPE	SPECIFIER
ALIAS	ConveyorProgram	Output_Conveyor		BOOL	Local2:O.Data.2
TAG	ConveyorProgram	PB_Conveyor		BOOL	
TYPE	SCOPE	NAME	DESCRIPTION	DATATYPE	SPECIFIER
ALIAS	MainProgram	Output_Light		BOOL	Local2:O.Data.1
TAG	MainProgram	PB		BOOL	

4. Open EasyBuilder project file, select the driver and set IP address. Click **[Data Type]** to open **[Structure Editor]** and edit the data type of the tags.

TYPE	SCOPE	NAME	DESCRIPTION	DATATYPE	SPECIFIER	ATTRIBUTES
TAG		Local:1:C		AB:Embedded_IQ16F:C:0		
TAG		Local:1:I		AB:Embedded_IQ16F:I:0		
TAG		Local:2:C		AB:Embedded_OB16:C:0		
TAG		Local:2:I		AB:Embedded_OB16:I:0		
TAG		Local:2:O		AB:Embedded_OB16:O:0		

TYPE	SCOPE	NAME	DESCRIPTION	DATATYPE	SPECIFIER
ALIAS	ConveyorProgram	Output_Conveyor			Local:2:O.Data.2
TAG	ConveyorProgram	PB_Conveyor		BOOL	

TYPE	SCOPE	NAME	DESCRIPTION	DATATYPE	SPECIFIER
ALIAS	MainProgram	Output_Light			Local:2:O.Data.1
TAG	MainProgram	PB		BOOL	

5. In **[Structure Editor]** edit the data type of **[Program Tag]**.

The imported csv file is shown below:

Note: The Program Tag can directly be imported in EasyBuilder Pro V3.00.05, EasyBuilder 8000 V4.65.08, and the later versions. Please go to step 6 without editing manually.

7	TYPE	SCOPE	NAME	DESCRIPTION	DATATYPE	SPECIFIER
8	TAG		Local:1:C		AB:Embedded_IQ16F:C:0	
9	TAG		Local:1:I		AB:Embedded_IQ16F:I:0	
10	TAG		Local:2:C		AB:Embedded_OB16:C:0	
11	TAG		Local:2:I		AB:Embedded_OB16:I:0	
12	TAG		Local:2:O		AB:Embedded_OB16:O:0	
13	TAG		PB_ControllerTag		BOOL	
14	TYPE	SCOPE	NAME	DESCRIPTION	DATATYPE	SPECIFIER
15	TAG	ConveyorProgram	Output_Conveyor			Local:2:O.Data.2
16	TAG	ConveyorProgram	PB_Conveyor		BOOL	
17	TYPE	SCOPE	NAME	DESCRIPTION	DATATYPE	SPECIFIER
18	TAG	MainProgram	Output_Light			Local:2:O.Data.1
19	TAG	MainProgram	PB		BOOL	

Step 1

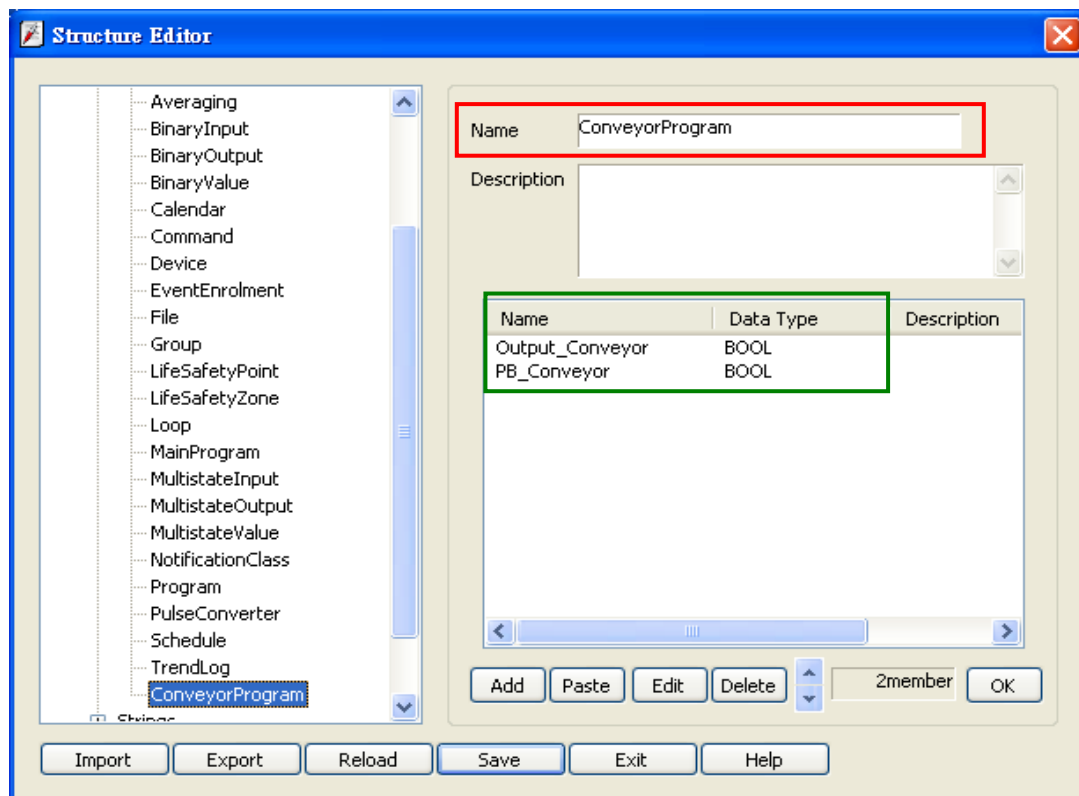
Right click on **[Structure Editor]** » **[User-Defined]** to add a **[new data type]**.

New Data Type...

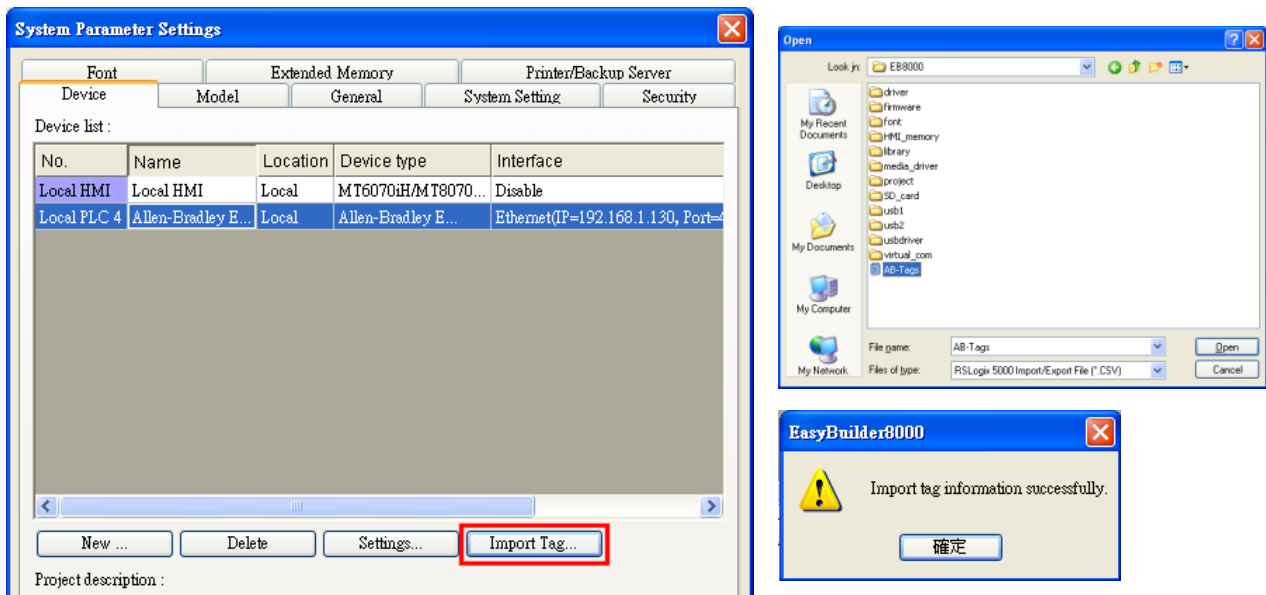
Step 2

After adding all Program Tags, click **[OK]** » **[Save]** » **[Exit]** to leave the editor dialog.

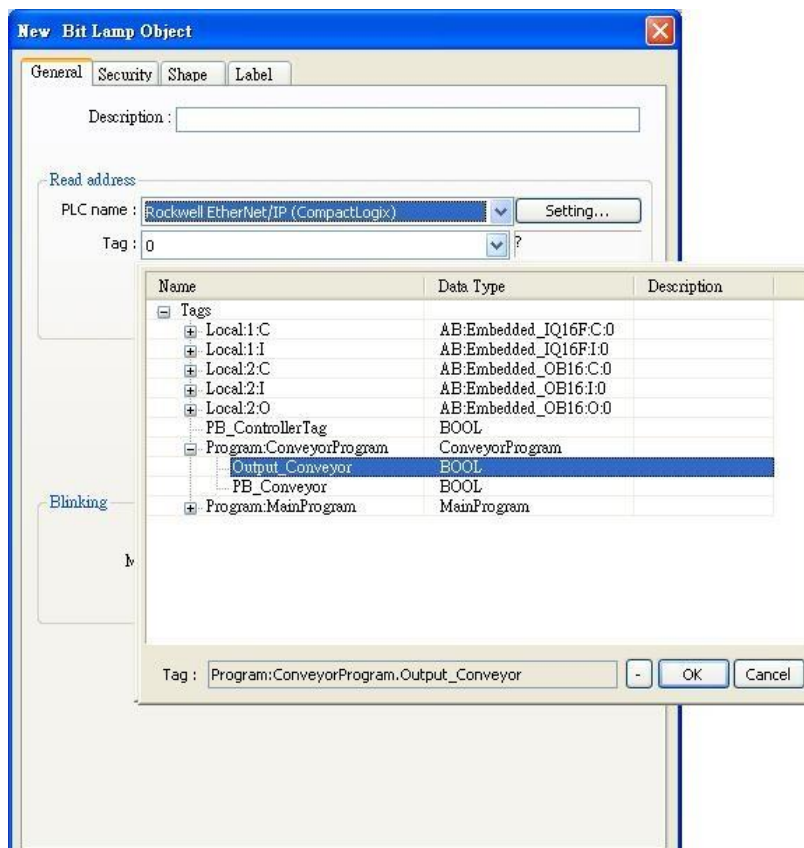
TYPE	SCOPE	NAME	DESCRIPTION	DATATYPE	SPECIFIER
ALIAS	ConveyorProgram	Output_Conveyor			Local:2:O.Data.2
TAG	ConveyorProgram	PB_Conveyor		BOOL	
TYPE	SCOPE	NAME	DESCRIPTION	DATATYPE	SPECIFIER
ALIAS	MainProgram	Output_Light			Local:2:O.Data.1
TAG	MainProgram	PB		BOOL	



- In **[System Parameter Settings]**, click **[Import Tag]**, select the csv file. After importing a message window is displayed.



- In the object property dialog, select PLC Tag address.



Device Address:

PLC data type name	Bit/Word	EasyBuilder data format	Memo
BOOL	Boolean	Bit object	
BitArray			
SINT			
INT	Integer	16-bit signed, ASCII	-32768 ~ 32767
DINT	Double Integer	32-bit signed	$-2^{31} \sim (2^{31}-1)$
REAL	Single Precision Float	32-bit Float	IEEE 754

Wiring Diagram:

Diagram 1

Ethernet cable:



Rockwell EtherNet/IP (ControlLogix) – Free Tag Names

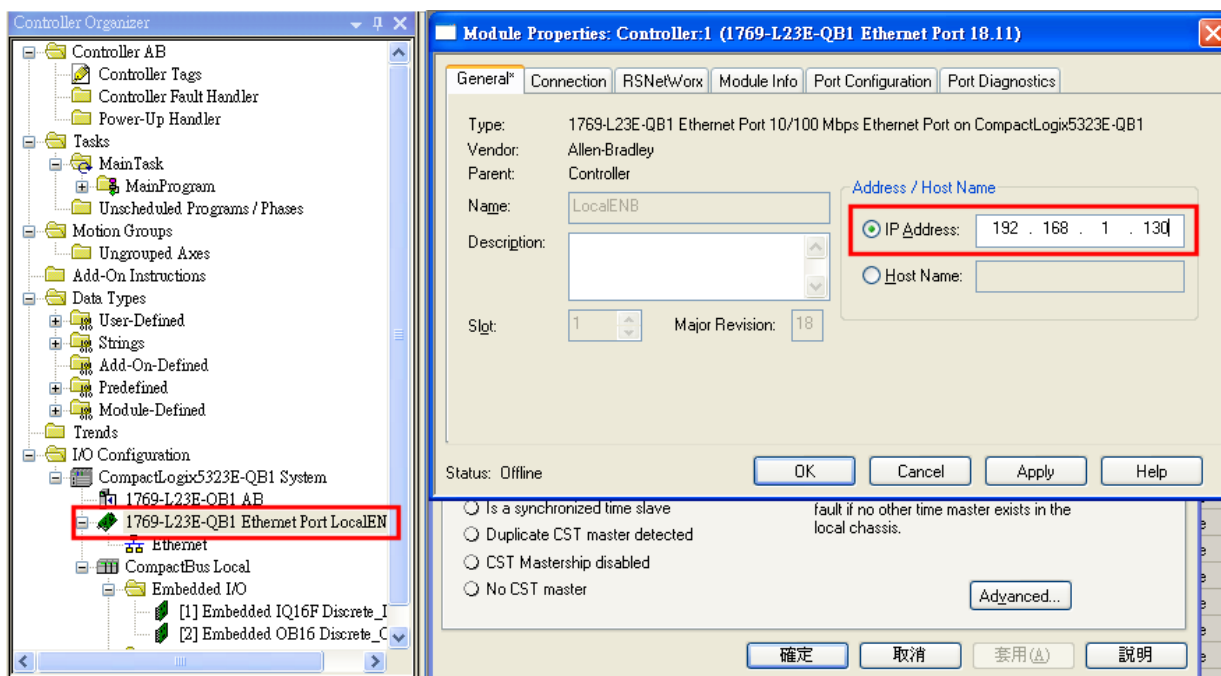
Supported Series: Rockwell ControlLogix, CompactLogix, FlexLogix Ethernet, CompactLogix 1768-L43 1768-L45 with 1768-ENBT/A Ethernet module
 Website: <http://www.ab.com>

HMI Setting:

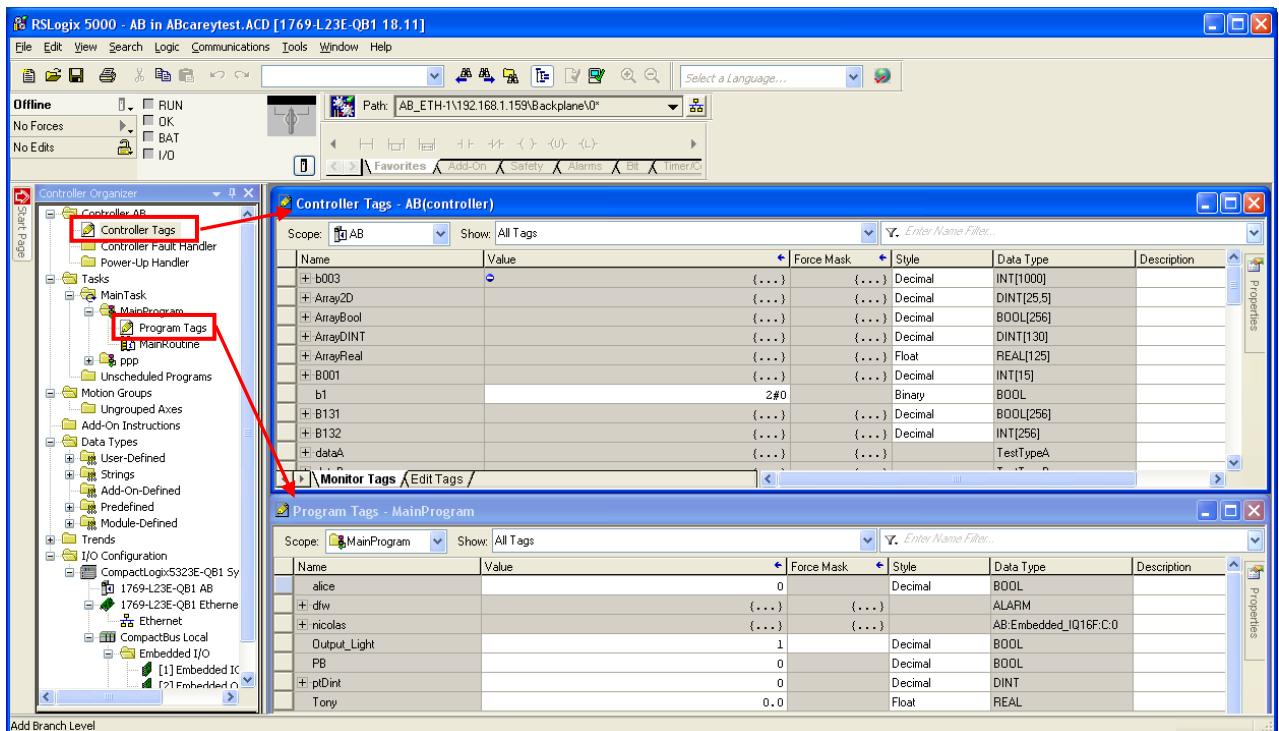
Parameters	Recommended	Options	Notes
PLC type	Rockwell EtherNet/IP (ControlLogix) – Free Tag Names		
PLC I/F	Ethernet		
Port no.	44818		
PLC sta. no.	The same as CPU Slot No.		

PLC Setting:

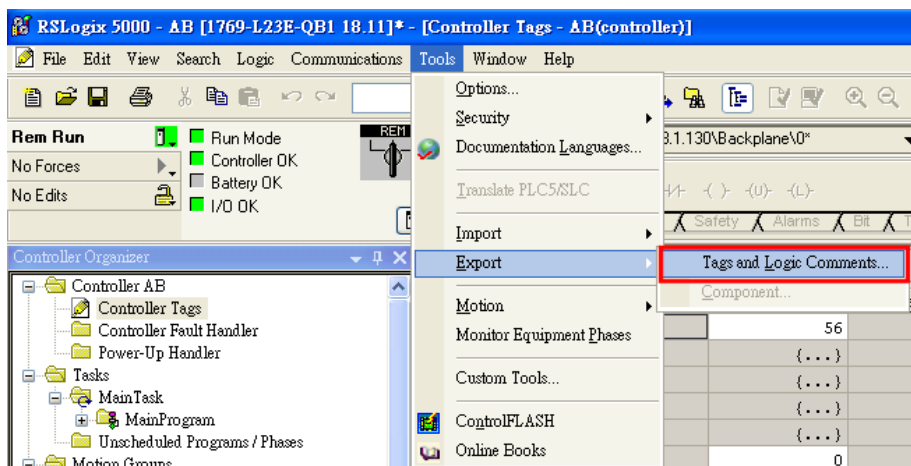
1. Set PLC IP address.



2. Create new tags (Controller Tags and Program Tags supported).



3. Export Tag data to CSV file. ([Tools] » [Export] » [Tags and Logic Comments])



Note: The separator character in CSV file must be a comma “,” otherwise the file is invalid.

The directory of changing system settings: [Control Panel] » [Date, Time, Language, and Regional Options] » [Change the format of numbers, dates, and times] » [Customize] » [List separator]. Please select “,” and export CSV file after setting.

TYPE	SCOPE	NAME	DESCRIPTION	DATATYPE	SPECIFIER
ALIAS	ConveyorProgram	Output_Conveyor		BOOL	Local2:O.Data.2
TAG	ConveyorProgram	PB_Conveyor		BOOL	
TYPE	SCOPE	NAME	DESCRIPTION	DATATYPE	SPECIFIER
ALIAS	MainProgram	Output_Light		BOOL	Local2:O.Data.1
TAG	MainProgram	PB		BOOL	

4. Open EasyBuilder project file, select the driver and set IP address. Click **[Data Type]** to open **[Structure Editor]** and edit the data type of the tags.

TYPE	SCOPE	NAME	DESCRIPTION	DATATYPE	SPECIFIER	ATTRIBUTES
TAG		Local:1:C		AB:Embedded_IQ16F:C:0		
TAG		Local:1:I		AB:Embedded_IQ16F:I:0		
TAG		Local:2:C		AB:Embedded_OB16:C:0		
TAG		Local:2:I		AB:Embedded_OB16:I:0		
TAG		Local:2:O		AB:Embedded_OB16:O:0		

TYPE	SCOPE	NAME	DESCRIPTION	DATATYPE	SPECIFIER
ALIAS	ConveyorProgram	Output_Conveyor			Local:2:O.Data.2
TAG	ConveyorProgram	PB_Conveyor		BOOL	
TYPE	SCOPE	NAME	DESCRIPTION	DATATYPE	SPECIFIER
ALIAS	MainProgram	Output_Light			Local:2:O.Data.1
TAG	MainProgram	PB		BOOL	

5. In **[Structure Editor]** edit the data type of **[Program Tag]**.

The imported csv file is shown below:

Note: The Program Tag can directly be imported in EasyBuilder Pro V3.00.05, EasyBuilder 8000 V4.65.08, and the later versions. Please go to step 6 without editing manually.

7	TYPE	SCOPE	NAME	DESCRIPTION	DATATYPE	SPECIFIER
8	TAG		Local:1:C		AB:Embedded_IQ16F:C:0	
9	TAG		Local:1:I		AB:Embedded_IQ16F:I:0	
10	TAG		Local:2:C		AB:Embedded_OB16:C:0	
11	TAG		Local:2:I		AB:Embedded_OB16:I:0	
12	TAG		Local:2:O		AB:Embedded_OB16:O:0	
13	TAG		PB_ControllerTag		BOOL	
14	TYPE	SCOPE	NAME	DESCRIPTION	DATATYPE	SPECIFIER
15	TAG	ConveyorProgram	Output_Conveyor			Local:2:O.Data.2
16	TAG	ConveyorProgram	PB_Conveyor		BOOL	
17	TYPE	SCOPE	NAME	DESCRIPTION	DATATYPE	SPECIFIER
18	TAG	MainProgram	Output_Light			Local:2:O.Data.1
19	TAG	MainProgram	PB		BOOL	

Step 1

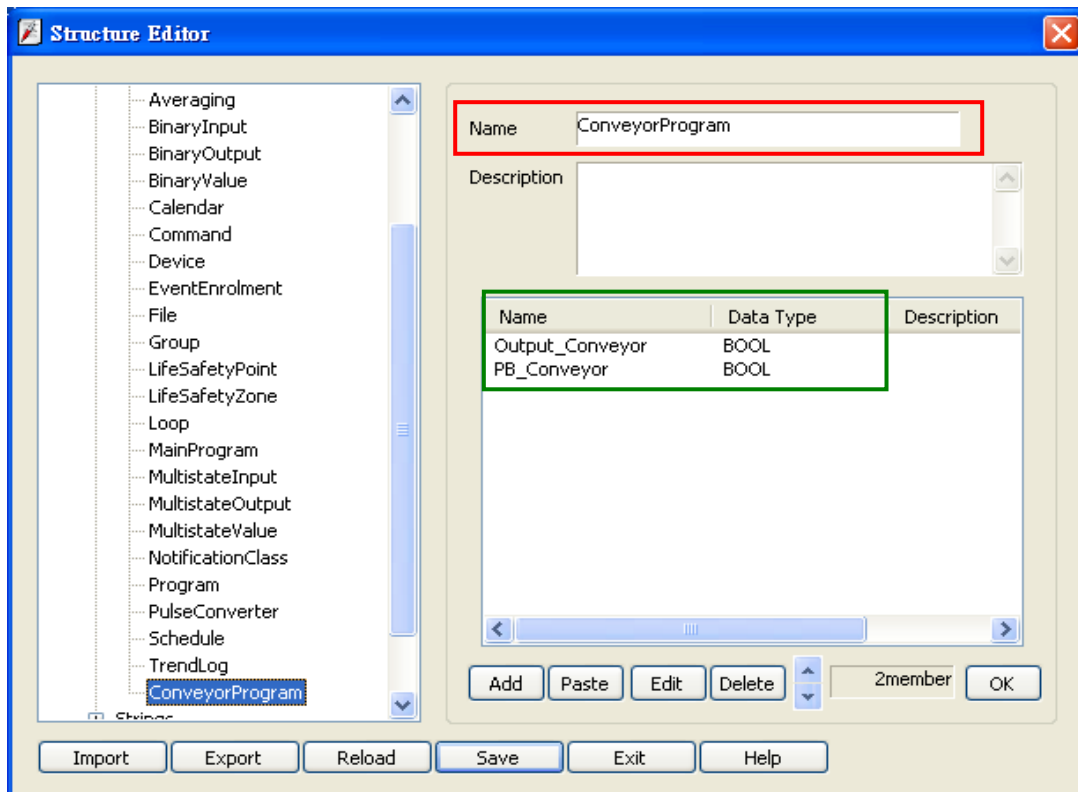
Right click on **[Structure Editor]** » **[User-Defined]** to add a **[new data type]**.

New Data Type...

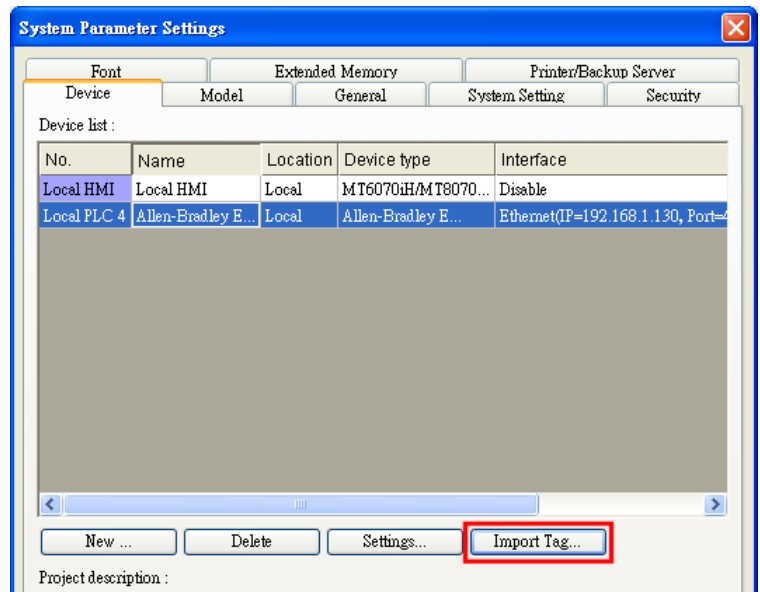
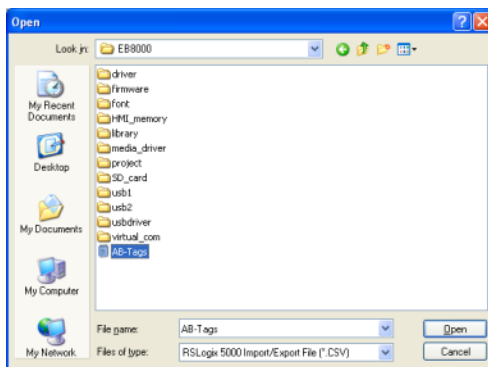
Step 2

After adding all Program Tags, click **[OK]** » **[Save]** » **[Exit]** to leave the editor dialog.

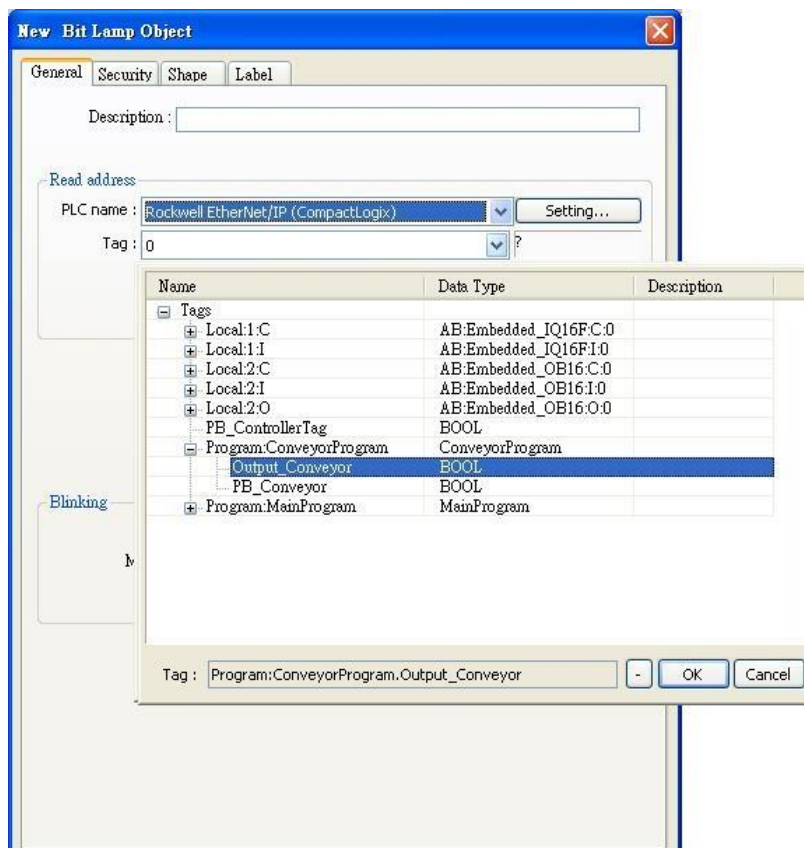
TYPE	SCOPE	NAME	DESCRIPTION	DATATYPE	SPECIFIER
ALIAS	ConveyorProgram	Output_Conveyor			Local:2:O.Data.2
TAG	ConveyorProgram	PB_Conveyor		BOOL	
TYPE	SCOPE	NAME	DESCRIPTION	DATATYPE	SPECIFIER
ALIAS	MainProgram	Output_Light			Local:2:O.Data.1
TAG	MainProgram	PB		BOOL	



6. In **[System Parameter Settings]**, click **[Import Tag]**, select the csv file. After importing a message window is displayed.



7. In the object property dialog, select PLC Tag address.



Device Address:

PLC data type name	Bit/Word	EasyBuilder data format	Memo
BOOL	Boolean	Bit object	
BitArray			
SINT			
INT	Integer	16-bit signed, ASCII	-32768 ~ 32767
DINT	Double Integer	32-bit signed	$-2^{31} \sim (2^{31}-1)$
REAL	Single Precision Float	32-bit Float	IEEE 754

Wiring Diagram:

Diagram 1

Ethernet cable:



Rockwell EtherNet/IP (DF1)

Supported Series: Rockwell MicroLogix 1100, 1400, SLC5/05 Ethernet port.

MicroLogix1000, 1200, 1500, SLC 5/03, 5/04 with 1761-NET-ENI

Website: <http://www.ab.com>

HMI Setting:

Parameters	Recommended	Options	Notes
PLC type	Rockwell EtherNet/IP (DF1)		
PLC I/F	Ethernet		
Port no.	44818		
HMI sta. no.	0		
PLC sta. no.	1		

PLC Setting:

Communication mode	Port Setting: 10/100 Mbps Full Duplex/Half Duplex
---------------------------	---

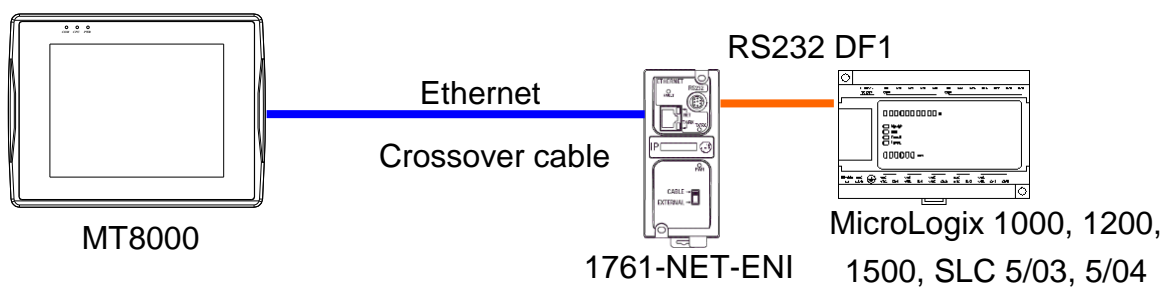
Device Address:

Bit/Word	Device	Format	Range	Memo
B	I1	DDDdd	0 ~ 25515	Input (I)
B	O0	DDDdd	0 ~ 25515	Output (O)
B	I1n_Bit	SSEEd	0 ~ 303115	SS: slot, EE: sub element, dd:bit
B	O0n_Bit	SSEEd	0 ~ 303115	SS: slot, EE: sub element, dd:bit
B	B3	DDDdd	0 ~ 25515	Bit data file (B3)
B	S_Bit	DDDDDDdd	0 ~ 25525515	Status file
B	Bfn	FFFDDDDdd	0 ~ 25525515	Bit data file (B3, 10 ~ 254)
B	NfnBit	FFFDDDDdd	0 ~ 25525515	Integer data file bit level (N7, 10 ~ 254)
W	I1n	SSEE	0 ~ 3031	SS: slot, EE: sub element
W	O0n	SSEE	0 ~ 3031	SS: slot, EE: sub element
W	T4SV	DDD	0 ~ 255	Timer Preset Value (T4)
W	T4PV	DDD	0 ~ 255	Timer Accumulator Value (T4)
W	C5SV	DDD	0 ~ 255	Counter Preset Value (C5)
W	C5PV	DDD	0 ~ 255	Counter Accumulator Value (C5)
W	TfnSV	FFFDDD	0 ~ 255255	
W	TfnPV	FFFDDD	0 ~ 255255	

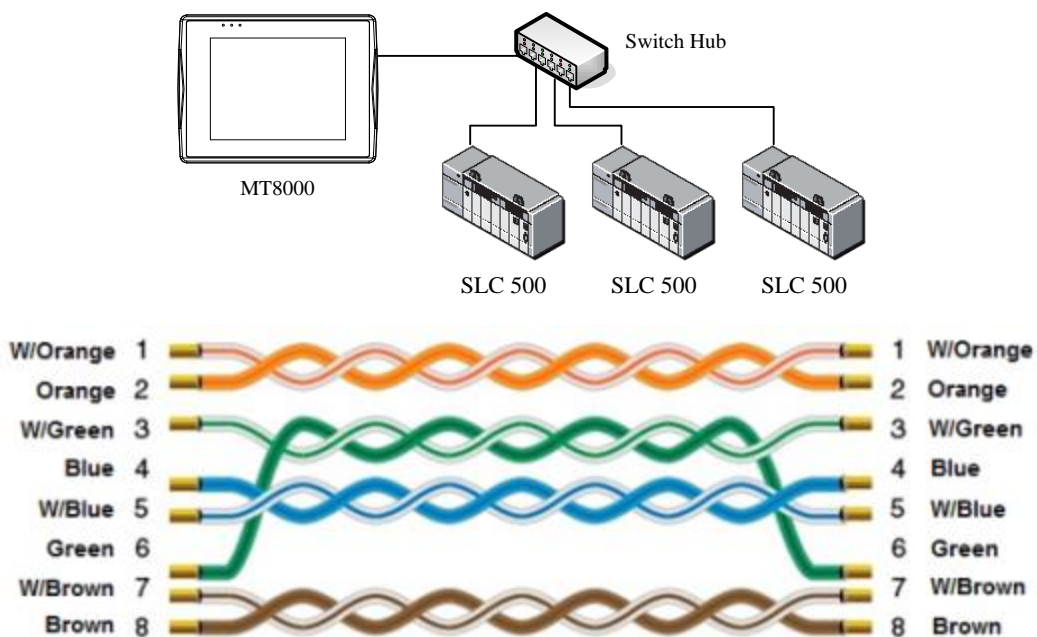
Bit/Word	Device	Format	Range	Memo
W	CfnSV	FFFDDD	0 ~ 255255	
W	CfnPV	FFFDDD	0 ~ 255255	
W	S	DDD	0 ~ 255	
W	N7	DDD	0 ~ 255	Integer data file (N7)
W	Nfn	FFFDDD	0 ~ 255255	Integer data file (N7, 10 ~ 254)
DW (F)	F8	DDD	0 ~ 255	Floating point data file (F8)
DW (F)	Ffn	FFFDDD	0 ~ 255255	Floating point data file (F8, 10 ~ 254)
DW	Lfn	FFFDDD	0 ~ 255255	Driver version 2.00 or later supported
W	STfn	DDD.DDD.DD	0 ~ 255.255.40	

Wiring Diagram:

Direct connect (crossover cable):



Through a hub:



Rockwell Micro850 (Ethernet) - Free Tag Names

Supported Series: Rockwell Micro820/850 Ethernet Module.

Website: <http://www.ab.com>

HMI Setting:

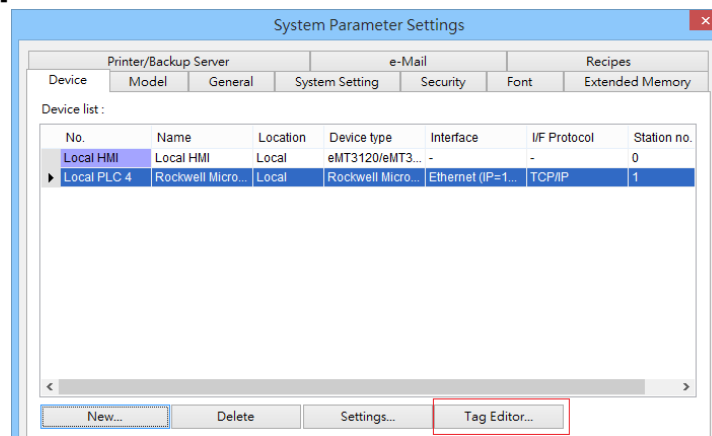
Parameters	Recommended	Options	Notes
PLC type	Rockwell Micro850 (Ethernet) - Free Tag Names		
PLC I/F	Ethernet		
Port no.	44818		
HMI sta. no.	0		
PLC sta. no.	1		

Support Device Type:

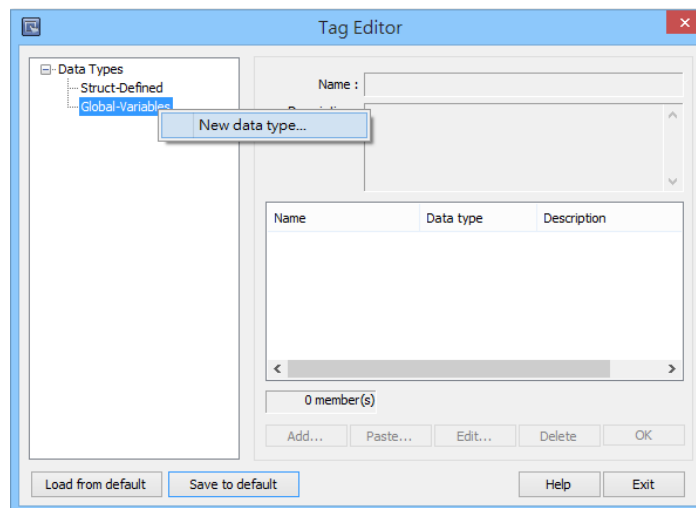
Data type	EasyBuilder data format	Memo
Bool	bit	
Byte	16-bit BCD, Hex, Binary, Unsigned	8-bit
SInt	16-bit BCD, Hex, Binary, Signed	8-bit
USInt	16-bit BCD, Hex, Binary, Unsigned	8-bit
Word	16-bit BCD, Hex, Binary, Unsigned	16-bit
Int	16-bit BCD, Hex, Binary, Signed	16-bit
UInt	16-bit BCD, Hex, Binary, Unsigned	16-bit
DWord	32-bit BCD, Hex, Binary, Unsigned	32-bit
DInt	32-bit BCD, Hex, Binary, Signed	32-bit
Real	32-bit Float	32-bit
UDInt	32-bit BCD, Hex, Binary, Unsigned	32-bit
String	ASCII Object	Length=word

How to Import Tags:

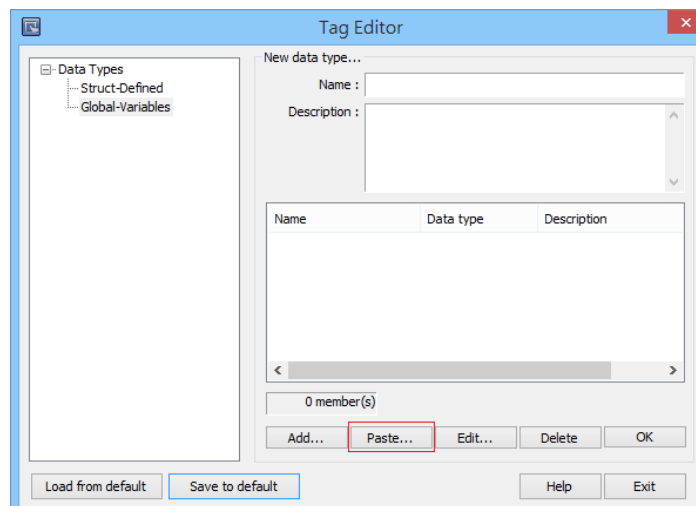
1. Click [Tag Editor].



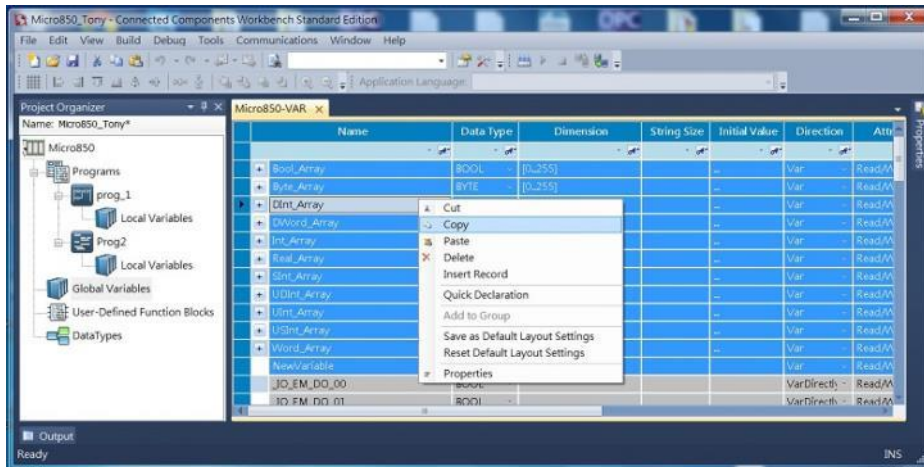
2. Right-click [Global-Variables] and select [New data type].



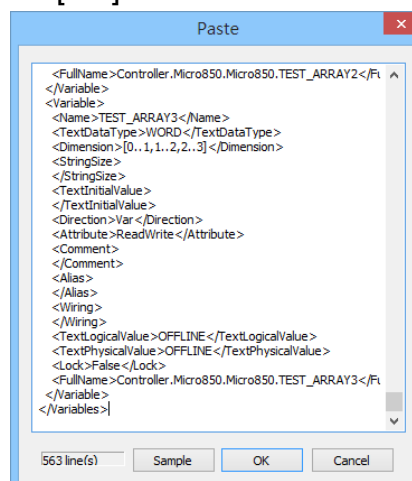
3. Click [Paste].



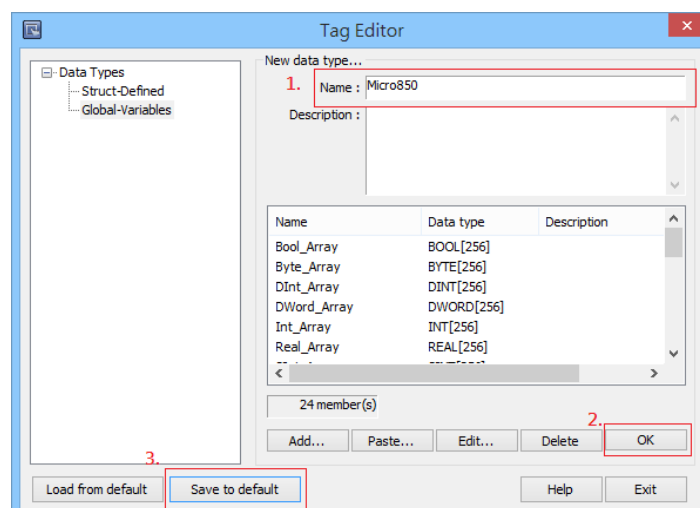
- Launch “Connected Components Workbench” software, select and copy the tags under [Global Variables]. Note that the IO address cannot be copied and can only be manually created.



- Paste the copied tags and click [OK].

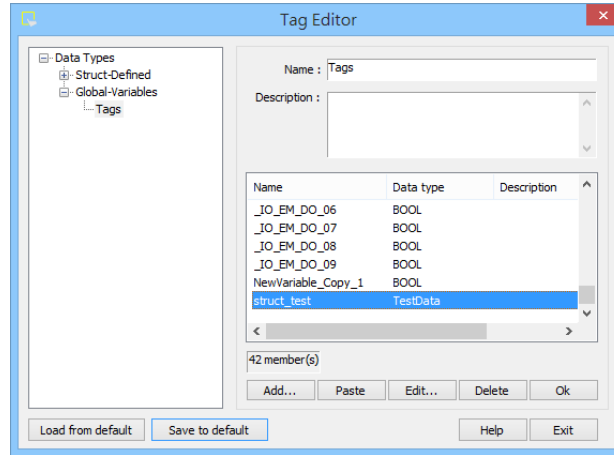


- Enter [Name], click [OK], and then click [Save to default]. The tags are now successfully created.

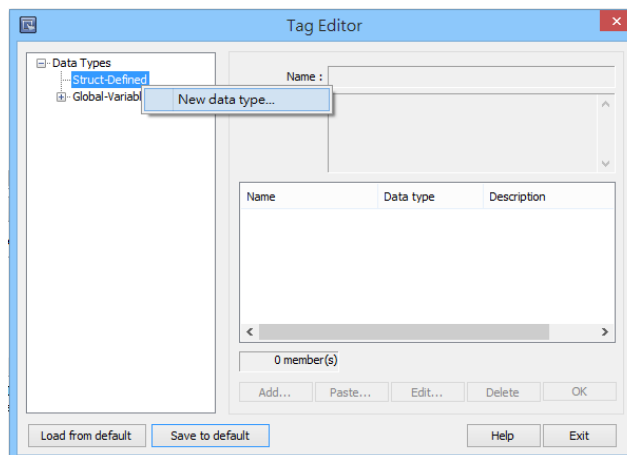


Building Struct:

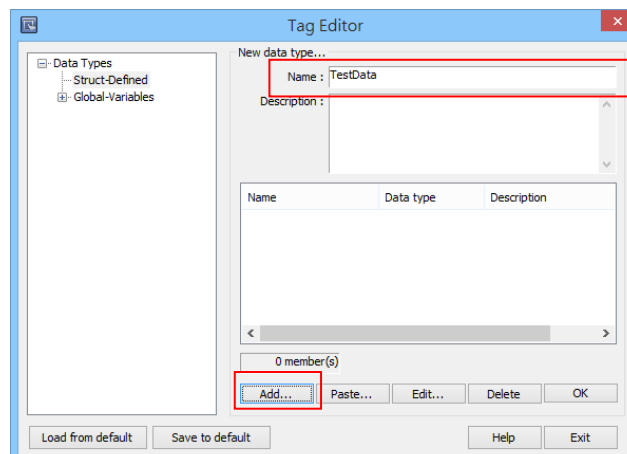
1. After importing the tags, the data type of Struct is shown as in the following figure, please build the corresponding tag under Struct-Defined.



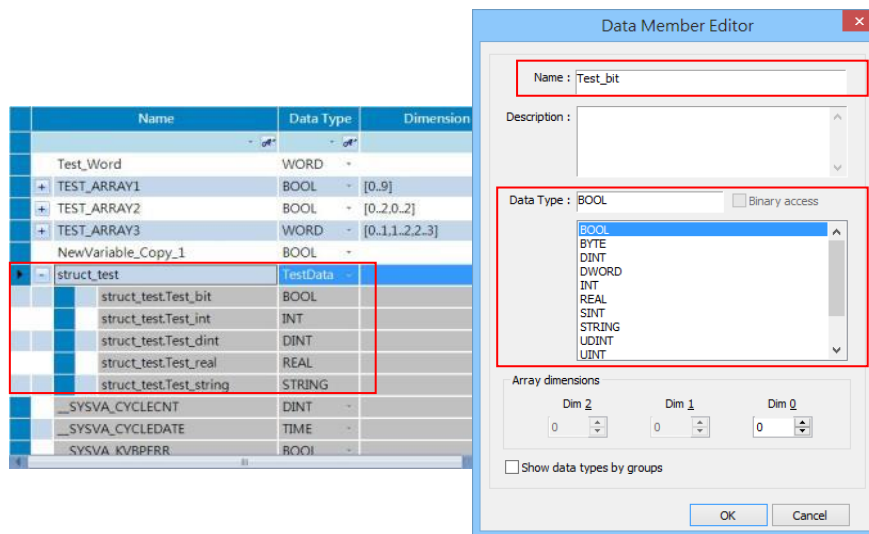
2. Right click on [Struct-Defined] and then select [New data type].



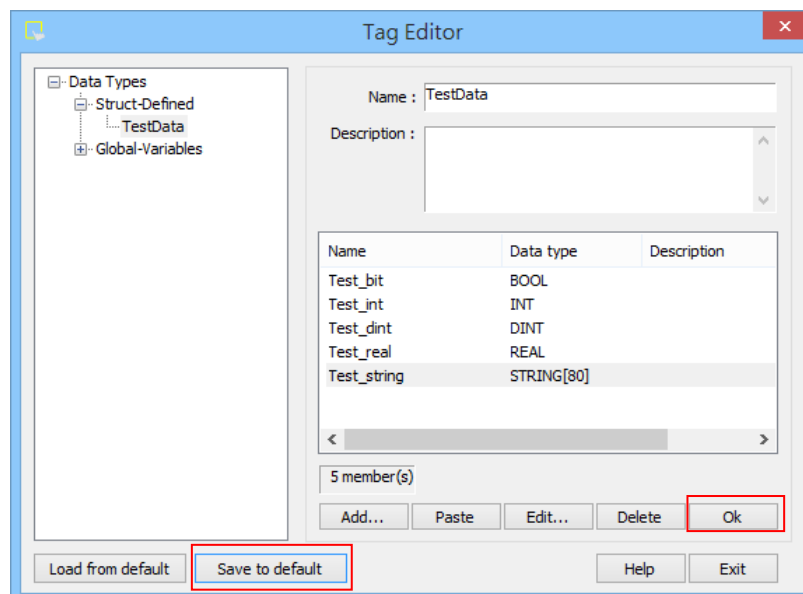
3. Enter the [Data type] in the [Name] field, and then click [Add].



- Enter the same information in the [Name] and [Data Type] fields as shown in the original factory software, and then click [OK].



- Upon completion click [OK] and then click [Save to default] to finish building Struct.



Wiring Diagram:

Ethernet cable:



Rockwell Micro850 - Free Tag Names

Supported Series: Rockwell Micro820/850

Website: <http://www.ab.com>

HMI Setting:

Parameters	Recommended	Options	Notes
PLC type	Rockwell Micro850 - Free Tag Names		
PLC I/F	RS232		
Baud rate	38400	1200 ~ 38400	
Data bits	8		
Parity	None	None,Even,Odd	
Stop bits	1		
PLC sta. no.	1	0 ~ 254	

PLC Setting:

Controller - Serial Port

Common Settings

Driver: CIP Serial ▼

Baud Rate: 38400 ▼

Parity: None ▼

Station Address: 1 ▲▼

Protocol Control

DF1 Mode: DF1 Full-Duplex

Control Line: No Handshake

Error Detection: CRC ▼

Embedded Responses: After One Received ▼

Duplicate Packet Detection

ACK Timeout (x20ms): 50 ENQ Retries: 3

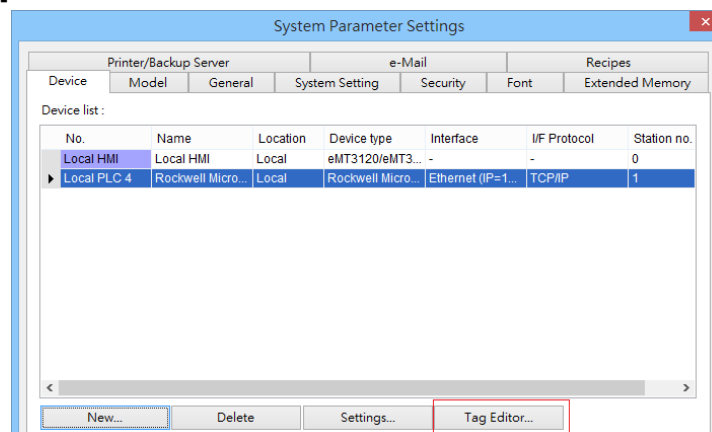
NAK Retries: 3 Transmit Retries: 3

Support Device Type:

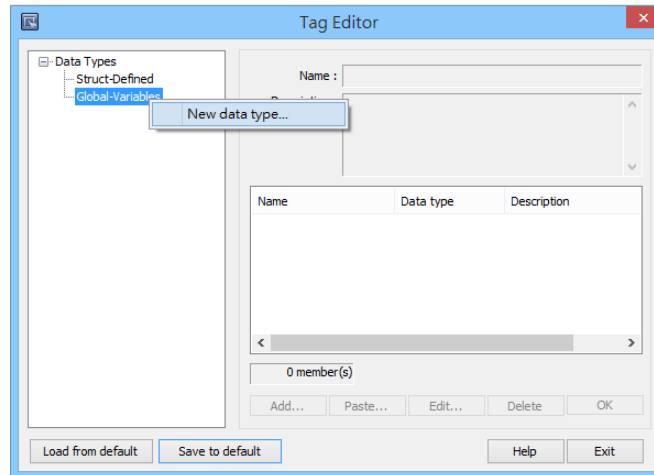
Data type	EasyBuilder data format	Memo
Bool	bit	
Byte	16-bit BCD, Hex, Binary, Unsigned	8-bit
SInt	16-bit BCD, Hex, Binary, Signed	8-bit
USInt	16-bit BCD, Hex, Binary, Unsigned	8-bit
Word	16-bit BCD, Hex, Binary, Unsigned	16-bit
Int	16-bit BCD, Hex, Binary, Signed	16-bit
UInt	16-bit BCD, Hex, Binary, Unsigned	16-bit
DWord	32-bit BCD, Hex, Binary, Unsigned	32-bit
DInt	32-bit BCD, Hex, Binary, Signed	32-bit
Real	32-bit Float	32-bit
UDInt	32-bit BCD, Hex, Binary, Unsigned	32-bit
String	ASCII Object	Length=word

How to Import Tags:

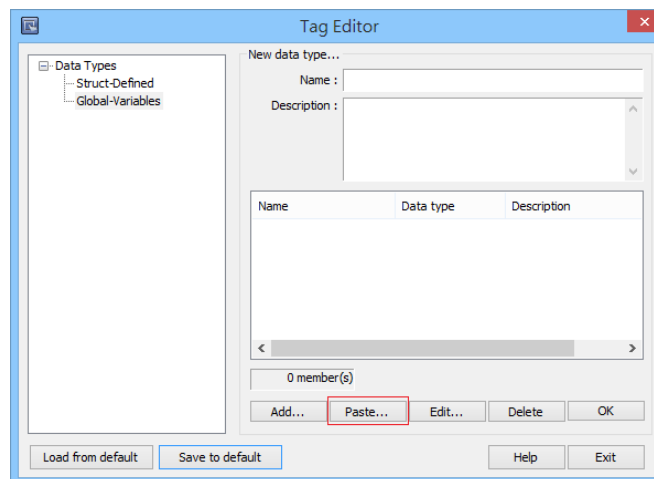
1. Click [Tag Editor].



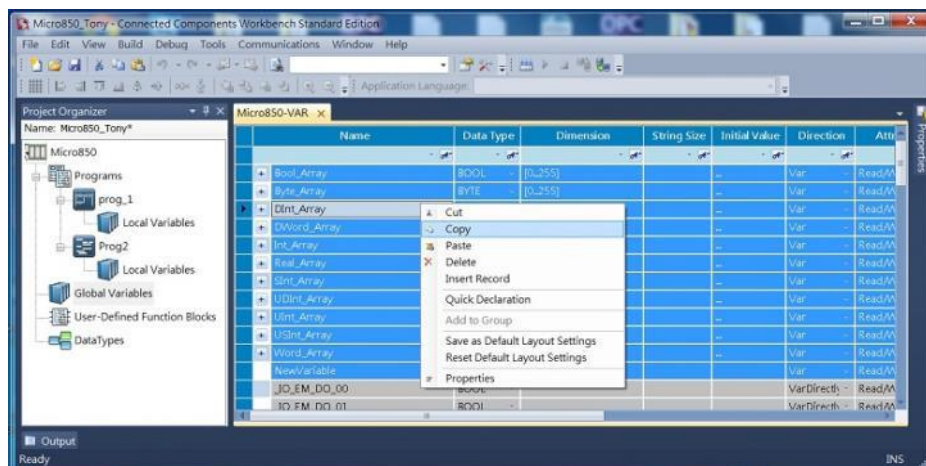
2. Right-click [Global-Variables] and select [New data type].



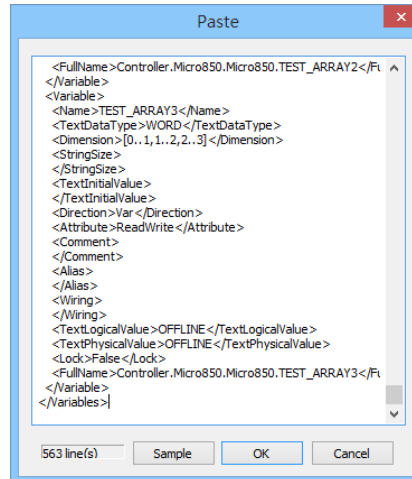
3. Click [Paste].



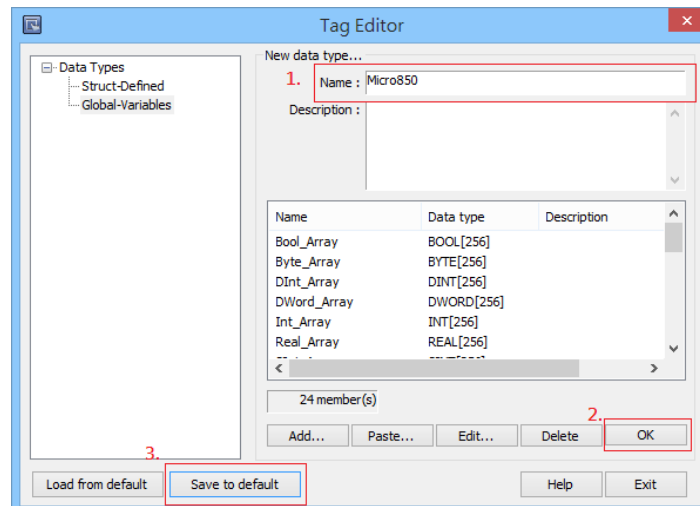
4. Launch “Connected Components Workbench” software, select and copy the tags under [Global Variables]. Note that the IO address cannot be copied and can only be manually created.



5. Paste the copied tags and click [OK].

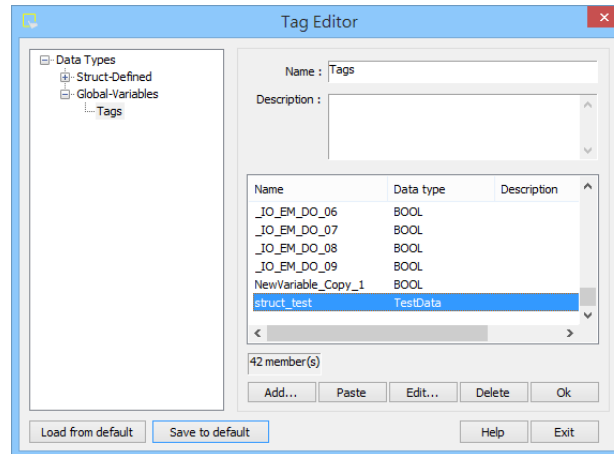


6. Enter [Name], click [OK], and then click [Save to default]. The tags are now successfully created.

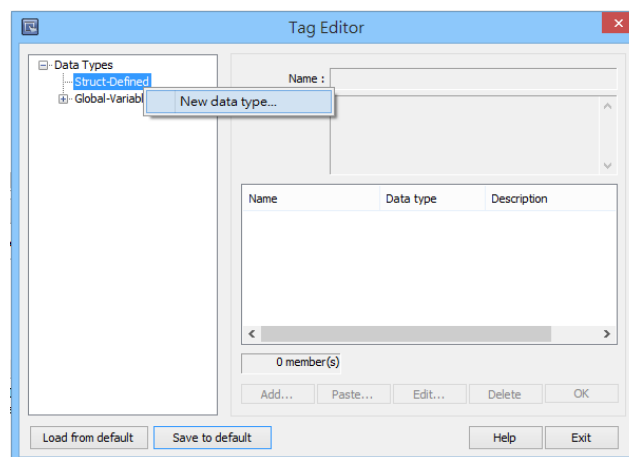


Building Struct:

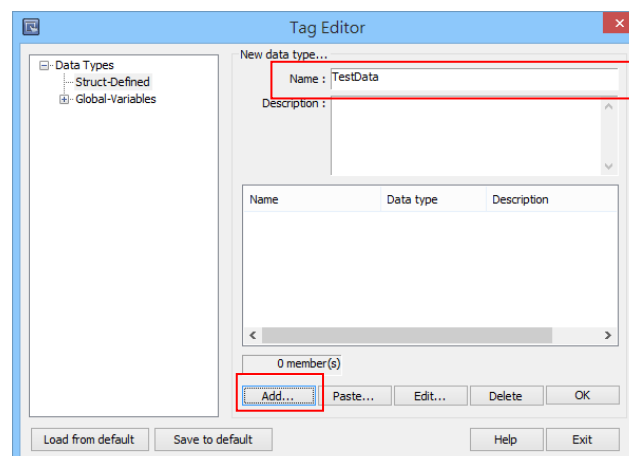
1. After importing the tags, the data type of Struct is shown as in the following figure, please build the corresponding tag under Struct-Defined.



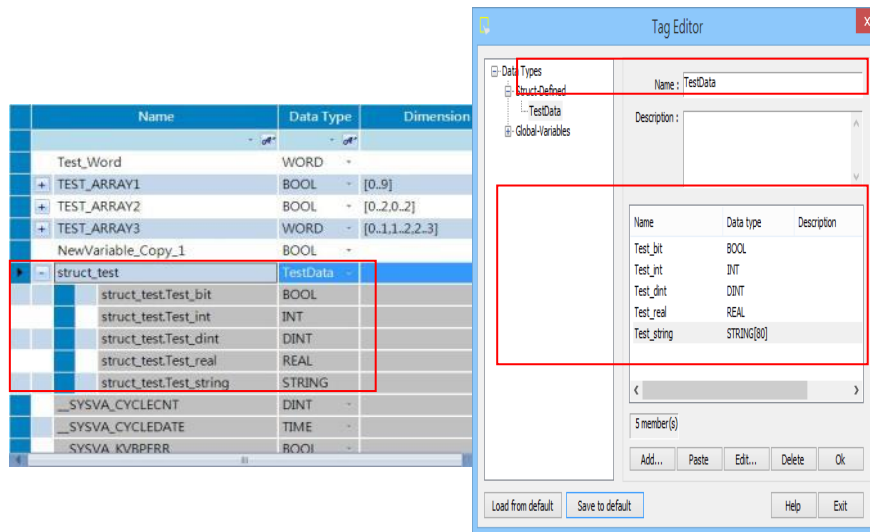
2. Right click on [Struct-Defined] and then select [New data type].



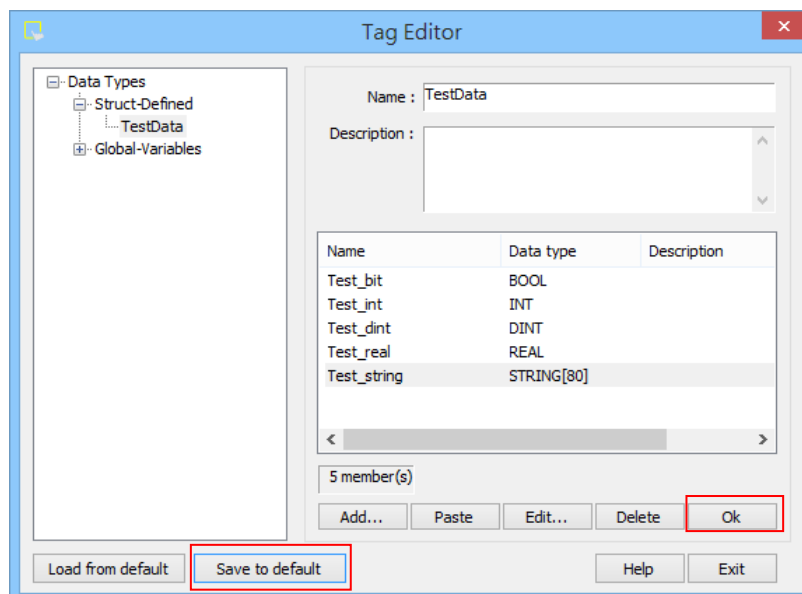
3. Enter the [Data type] in the [Name] field, and then click [Add].



- Enter the same information in the [Name] and [Data Type] fields as shown in the original factory software, and then click [OK].



- Upon completion click [OK] and then click [Save to default] to finish building Struct.



Wiring Diagram:

Diagram 1

cMT Series	<i>cMT3151</i>
eMT Series	<i>eMT3070 / eMT3105 / eMT3120 / eMT3150</i>
MT-iE	<i>MT8073iE / MT8102iE</i>
MT-XE	<i>MT8092XE</i>
MT-iP	<i>MT6103iP</i>

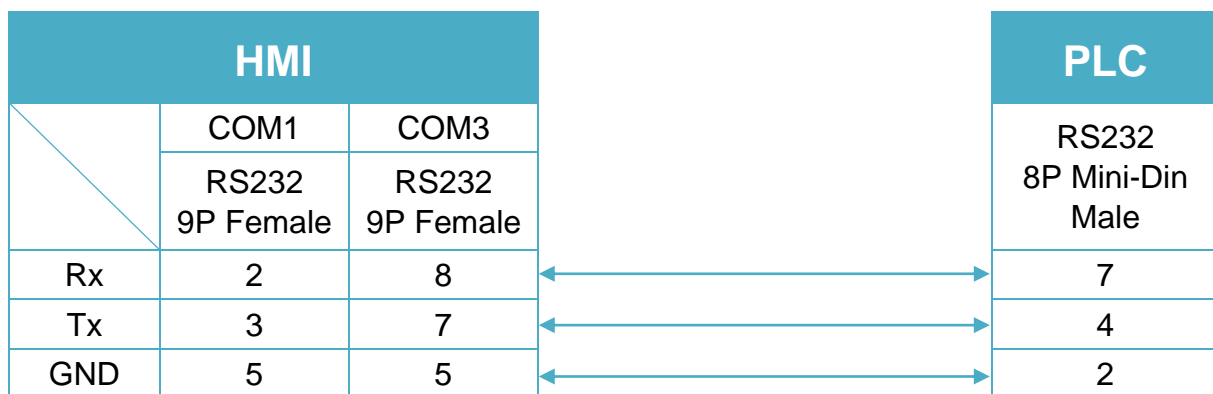


Diagram 2

cMT Series	<i>cMT-SVR</i>
mTV	<i>mTV</i>
MT-iE	<i>MT8070iE / MT6070iE / MT8100iE / MT8121iE / MT8150iE / MT8071iE / MT6071iE / MT8072iE / MT6072iE / MT8073iE / MT8101iE / MT8102iE / MT8103iE</i>
MT-XE	<i>MT8121XE / MT8150XE / MT8090XE</i>

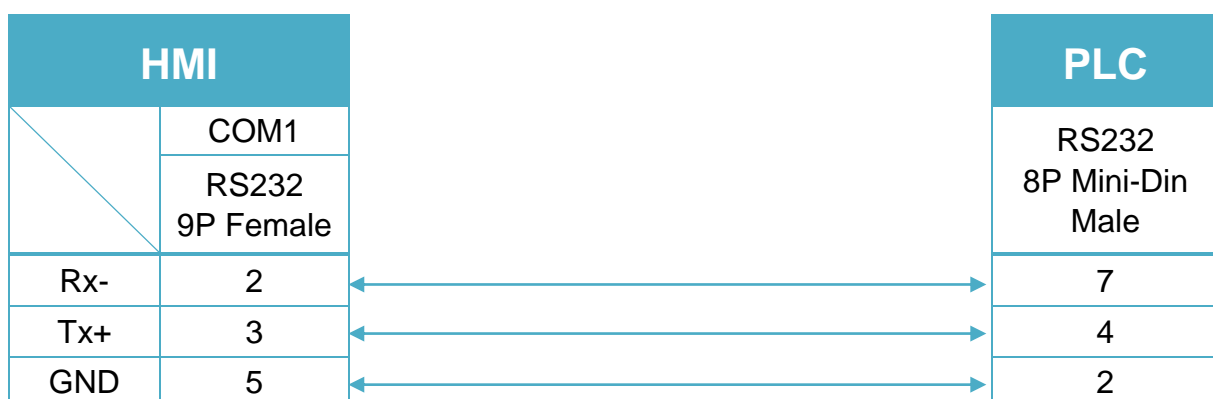
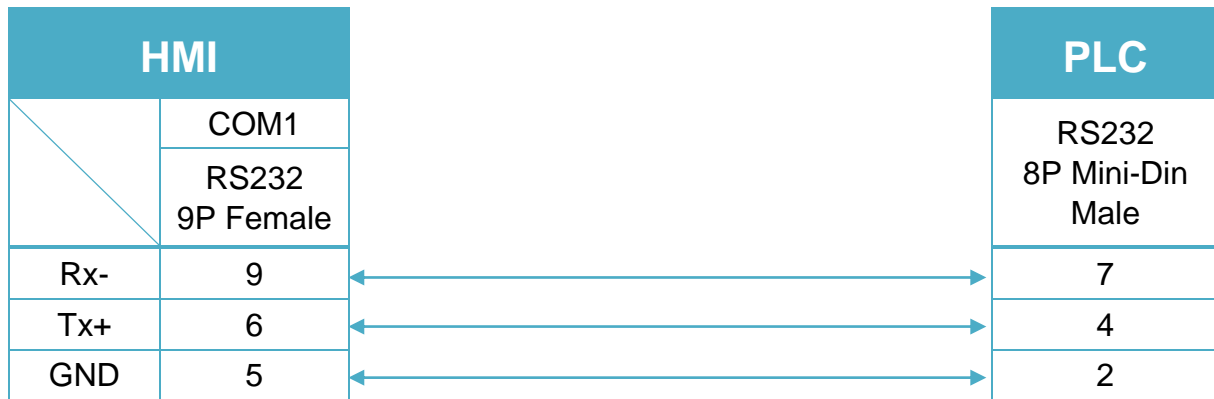


Diagram 3

MT-iE
MT8050iE
MT-iP
MT6051iP / MT6071iP / MT8071iP


Rockwell PLC5

Website: <http://www.ab.com>

Note: Rockwell PLC5 driver uses CRC checksum.

HMI Setting:

Parameters	Recommended	Options	Notes
PLC type	Rockwell PLC5		
PLC I/F	RS232		
Baud rate	19200	9600, 19200	
Data bits	8	8	
Parity	Even	Even, Odd, None	
Stop bits	1	1	
HMI sta. no.	0		
PLC sta. no.	1	1-31	

PLC Setting:

Communication mode	DF1 Full Duplex protocol 19200, None, 8, 1 (default)
---------------------------	--

Allen-Bradley PLC-5 Family PLCs use DF1 Full Duplex protocol.

For PLC-5/10, PLC-5/15 and PLC-5/25, MT8000 should be connected to the DF1 port on the 1785-KE module.

For PLC-5/11, PLC-5/20, PLC-5/30 and PLC-5/40, MT8000 should be connected to the Channel 0 Port on the PLC.

Device Address:

Bit/Word	Device	Format	Range	Memo
B	I1	DDDdd	0 ~ 25515	Input (I)
B	O0	DDDdd	0 ~ 25515	Output (O)
B	B3	DDDdd	0 ~ 99915	Bit data file (B3)
B	B10 ~ 13	DDDdd	0 ~ 99915	Bit data file (B10 ~ 13)
B	S_Bit	DDDDDDdd	0 ~ 25599915	
B	Bfn	FFFDDDDdd	0 ~ 25599915	
B	NfnBit	FFFDDDDdd	0 ~ 25599915	
W	T4SV	DDD	0 ~ 999	Timer Preset Value (T4)

Bit/Word	Device	Format	Range	Memo
W	T4PV	DDD	0 ~ 999	Timer Accumulator Value (T4)
W	C5SV	DDD	0 ~ 999	Counter Preset Value (C5)
W	C5PV	DDD	0 ~ 999	Counter Accumulator Value (C5)
W	TfnSV	FFFDDD	0 ~ 255999	
W	TfnPV	FFFDDD	0 ~ 255999	
W	CfnSV	FFFDDD	0 ~ 255999	
W	CfnPV	FFFDDD	0 ~ 255999	
W	N7	DDD	0 ~ 999	Integer data file (N7)
W	N10 ~ 15	DDD	0 ~ 999	Integer data file (N10 ~ 15)
W	Nfn	FFFDDD	0 ~ 255999	Integer data file (V2.5.0 or newer)
W	S	DDD	0 ~ 255	
W	F8	DDD	0 ~ 999	Floating point data file (F8)
W	Ffn	FFFDDD	0 ~ 255999	Floating point data file (V2.5.0 or newer)

Wiring Diagram:

9P D-Sub to 25P D-Sub: PLC5 CPU CH0

Diagram 1

cMT Series

cMT3151

eMT Series

eMT3070 / eMT3105 / eMT3120 / eMT3150

MT-iE

MT8073iE / MT8102iE

MT-XE

MT8092XE

MT-iP

MT6103iP

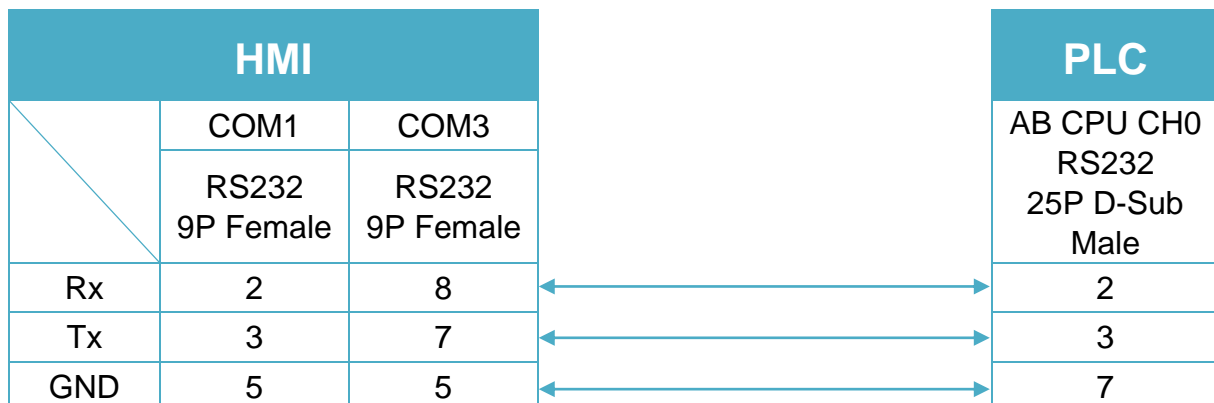


Diagram 2

cMT Series	cMT-SVR
mTV	mTV
MT-iE	MT8070iE / MT6070iE / MT8100iE / MT8121iE / MT8150iE / MT8071iE / MT6071iE / MT8072iE / MT6072iE / MT8073iE / MT8101iE / MT8102iE / MT8103iE
MT-XE	MT8121XE / MT8150XE / MT8090XE

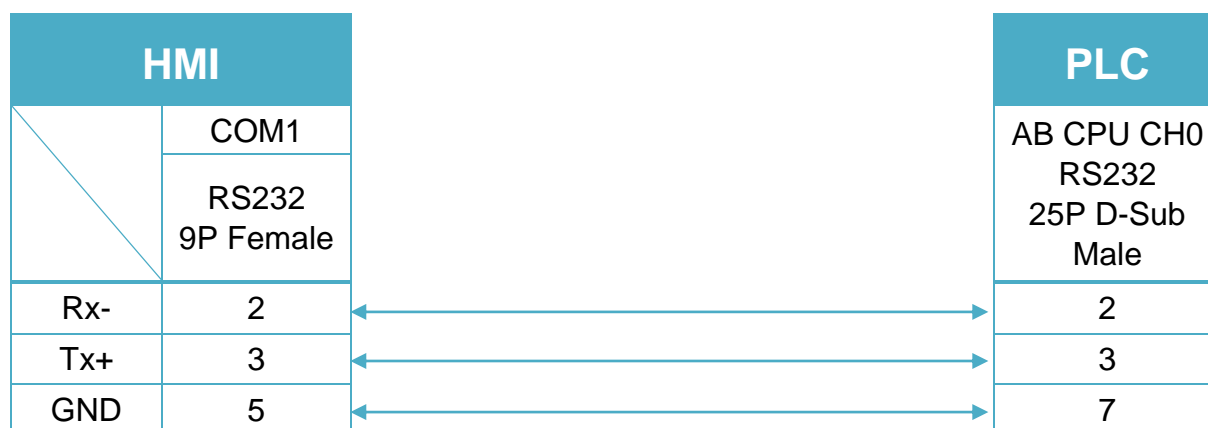
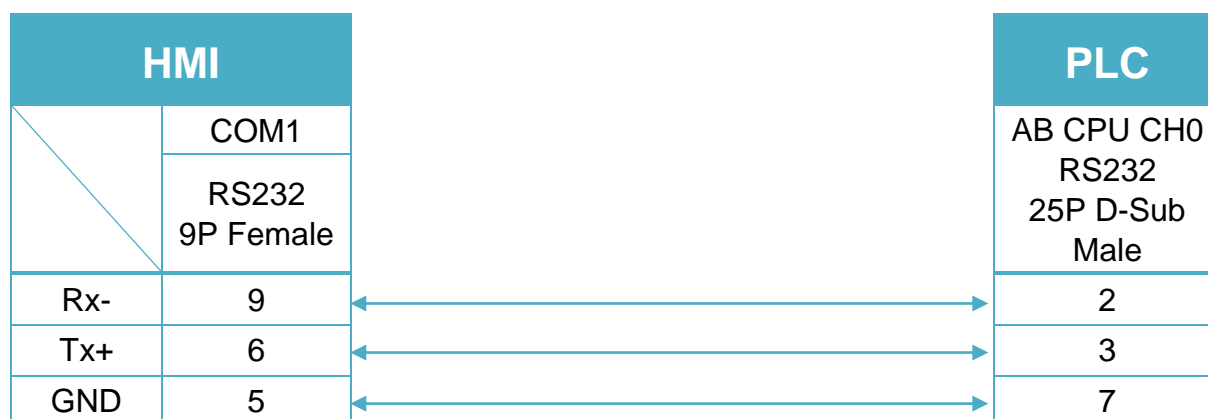


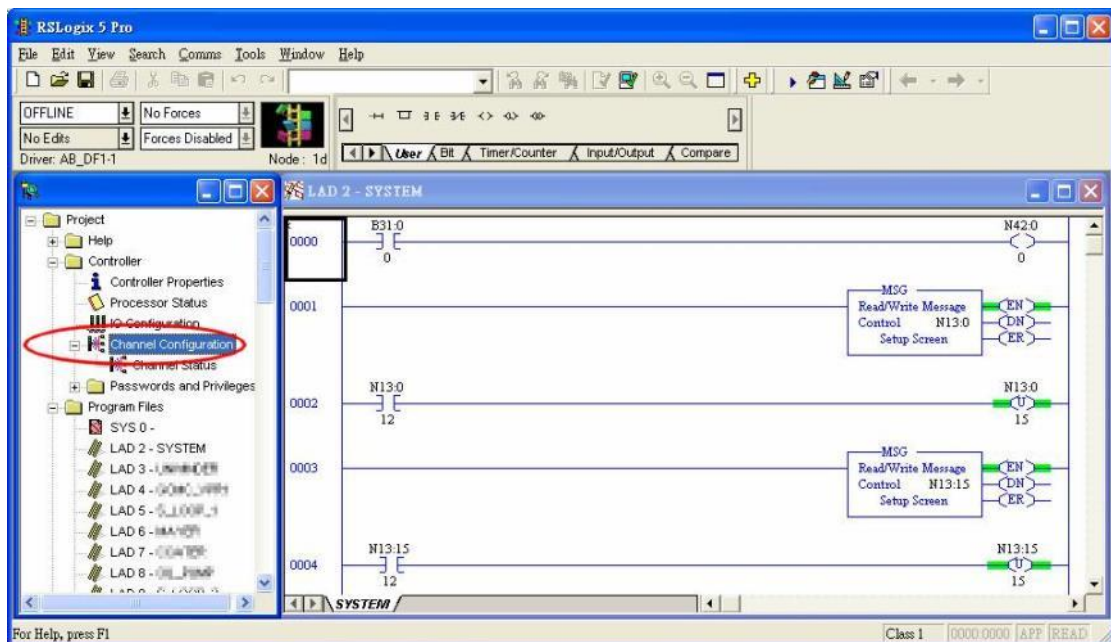
Diagram 3

MT-iE	MT8050iE
MT-iP	MT6051iP / MT6071iP / MT8071iP

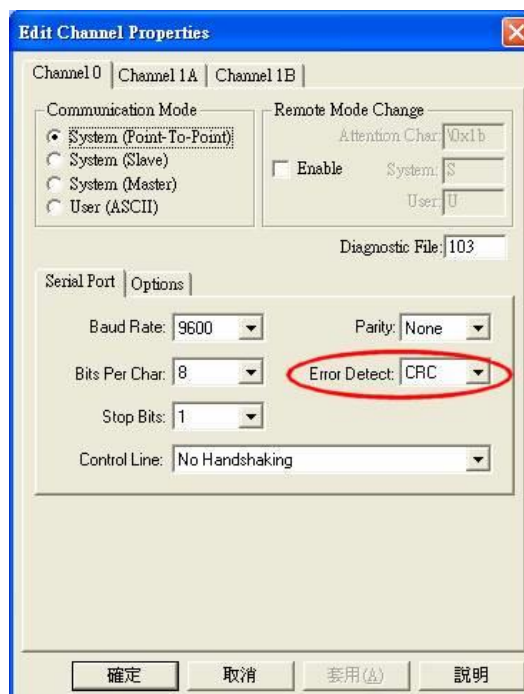


Note:

The default error checking of Rockwell PLC5 is BCC, whereas our driver is CRC.



Access [Channel Configuration] from RSLogix5, under Channel 0 tab, please select “CRC” for [Error Detect].



RS Automation OEMAX Series

Supported Series: OEMax NX7/NX7s Controllers.

Website: <http://www.oemax.co.kr>

HMI Setting:

Parameters	Recommended	Options	Notes
PLC type	RS Automation OEMAX Series		
PLC I/F	RS232		
Baud rate	9600	9600, 19200, 38400	
Data bits	8	8	
Parity	None	Even, Odd, None	
Stop bits	1	1	
PLC sta. no.	0		
HMI sta. no.	225	0 ~ 255	*Please correctly set HMI station number.

Device Address:

Bit/Word	Device type	Format	Range	Memo
B	R	DDDdd	0 ~ 25515	
B	L	DDDdd	0 ~ 25515	
B	M	DDDDdd	0 ~ 199915	
B	K	DDDdd	0 ~ 25515	Keep Contact
B	F	DDDdd	0 ~ 99115	Special Contact
B	TC	DDD	0 ~ 255	Timer/Counter
W	W	DDDD	0 ~ 7999	Data Register
W	SV	DDD	0 ~ 255	Timer/Counter Set Value
W	PV	DDD	0 ~ 255	Timer/Counter Preset Value
W	SR	DDD	0 ~ 255	Special Register
W	WR	DDD	0 ~ 255	
W	WL	DDD	0 ~ 255	
W	WM	DDDD	0 ~ 1999	
W	WK	DDD	0 ~ 255	
W	WF	DDD	0 ~ 991	

Wiring Diagram:

Diagram 1

cMT Series	<i>cMT3151</i>
eMT Series	<i>eMT3070 / eMT3105 / eMT3120 / eMT3150</i>
MT-iE	<i>MT8073iE / MT8102iE</i>
MT-XE	<i>MT8092XE</i>
MT-iP	<i>MT6103iP</i>

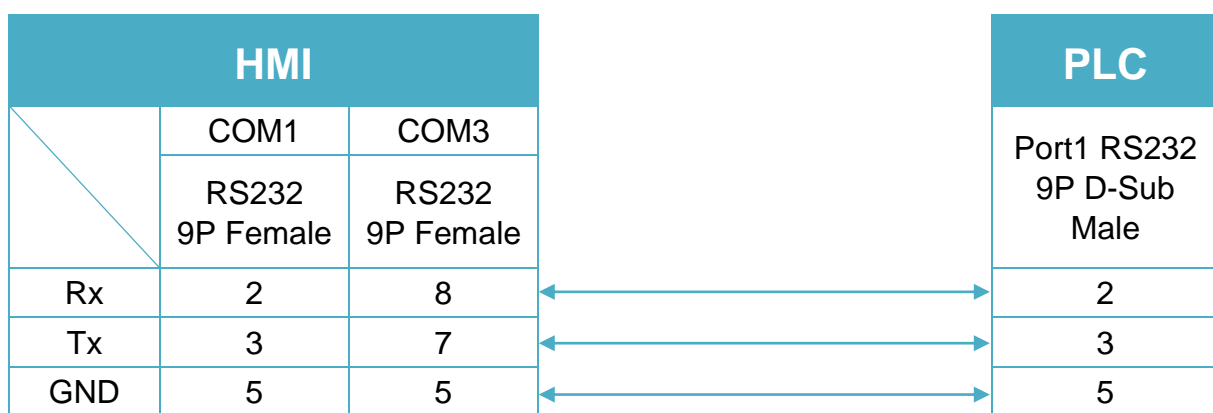


Diagram 2

cMT Series	<i>cMT-SVR</i>
mTV	<i>mTV</i>
MT-iE	<i>MT8070iE / MT6070iE / MT8100iE / MT8121iE / MT8150iE / MT8071iE / MT6071iE / MT8072iE / MT6072iE / MT8073iE / MT8101iE / MT8102iE / MT8103iE</i>
MT-XE	<i>MT8121XE / MT8150XE / MT8090XE</i>

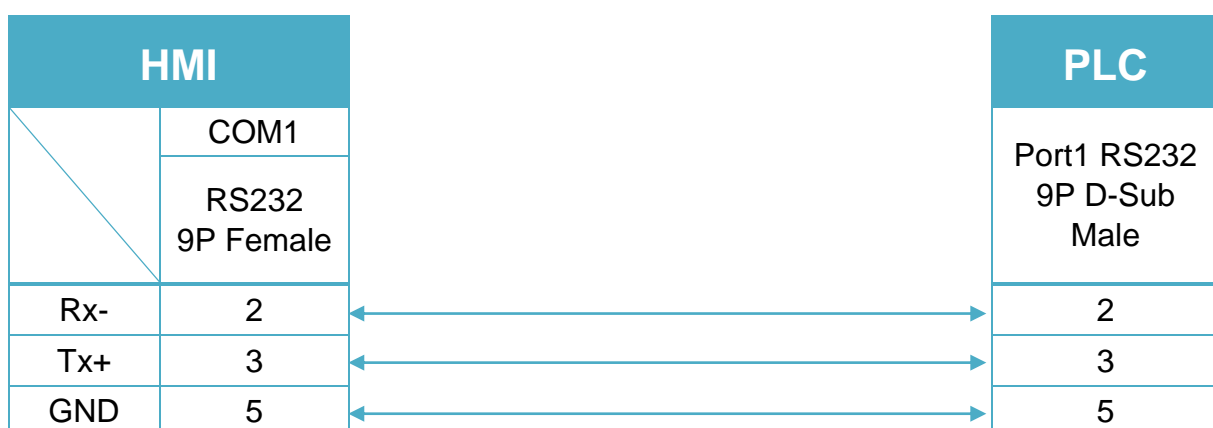
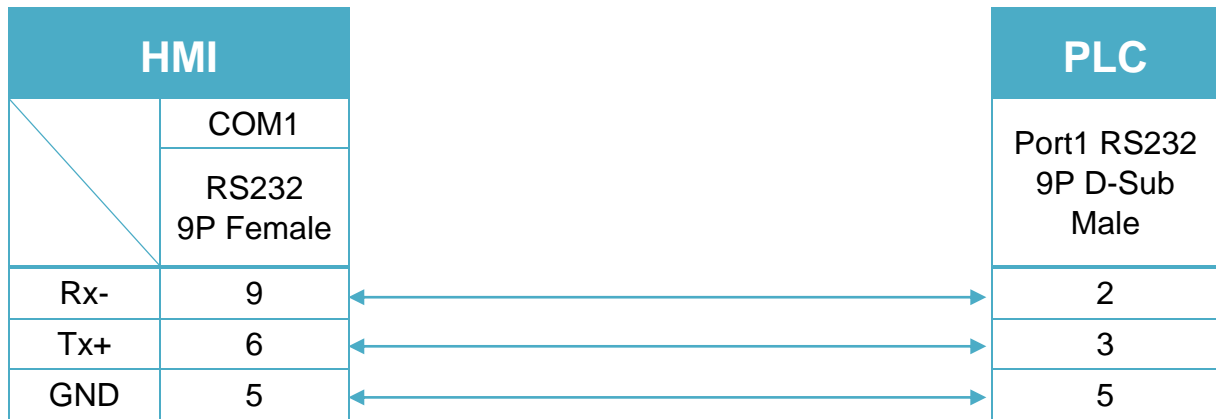


Diagram 3

MT-iE
MT8050iE
MT-iP
MT6051iP / MT6071iP / MT8071iP


RS Automation X8 Series

Supported Series: RS-X8 Series PLC

Website: <http://www.rsautomation.biz/>

HMI Setting:

Parameters	Recommended	Options	Notes
PLC type	RS Automation X8 Series		
PLC I/F	RS232/Ethernet	RS232/ Ethernet	
Baud rate	115200	9600~115200	
Data bits	8	7,8	
Parity	None	None,Even,ODD	
Stop bits	1	1,2	
Port no.	50000		
PLC sta. no.	1	0 ~ 255	

PLC Setting:

Communication mode	Xnet Slave
---------------------------	------------

Device Address:

Bit/Word	Device type	Format	Range	Memo
B	Y_bit	DD.DDDdd	0 ~ 96.25515	Output
B	X_bit	DD.DDDdd	0 ~ 96.25515	Input
B	SR_bit	DDDdd	0 ~ 12715	Status
B	B_bit	DDDD.DDDDdd	0 ~ 1535.153515	Bit
B	N_bit	DDDD.DDDDdd	0 ~ 1535.153515	Integer
B	A_bit	DDDD.DDDDdd	0 ~ 1535.153515	ASCII
B	TM_Done	DDDD.DDDDdd	0 ~ 1535.153515	Timer_Done
B	CT_Done	DDDD.DDDDdd	0 ~ 1535.153515	Counter_Done
B	CR_Done	DDDD.DDDDdd	0 ~ 1535.153515	Control_Done
W	Y	DD.DDD	0 ~ 96.255	Output
W	X	DD.DDD	0 ~ 96.255	Input
W	SR	DDD	0 ~ 127	Status
W	B	DDDD.DDDD	0 ~ 1535.1535	Bit
W	N	DDDD.DDDD	0 ~ 1535.1535	Integer

Bit/Word	Device type	Format	Range	Memo
W	A	DDDD.DDDD	0 ~ 1535.1535	ASCII
W	ST_Length	DDDD.DDD	0 ~ 1535.779	String_Length
W	ST_Data	DDDD.DDD.DD	0 ~ 1535.779.42	String_Data
W	CR_Length	DDDD.DDDD	0 ~ 1535.1535	Control_Length
W	CR_Pos	DDDD.DDDD	0 ~ 1535.1535	Control_Position
W	F	DDDD.DDDD	0 ~ 1535.1535	Float
W	L	DDDD.DDDD	0 ~ 1535.1535	Long
W	TM_Preset	DDDD.DDDD	0 ~ 1535.1535	Timer_Preset
W	TM_Acc	DDDD.DDDD	0 ~ 1535.1535	Timer_Accumulator
W	CT_Preset	DDDD.DDDD	0 ~ 1535.1535	Counter_Preset
W	CT_Acc	DDDD.DDDD	0 ~ 1535.1535	Counter_Accumulator

Wiring Diagram:

Diagram 1

cMT Series	<i>cMT3151</i>
eMT Series	<i>eMT3070 / eMT3105 / eMT3120 / eMT3150</i>
MT-iE	<i>MT8073iE / MT8102iE</i>
MT-XE	<i>MT8092XE</i>
MT-iP	<i>MT6103iP</i>

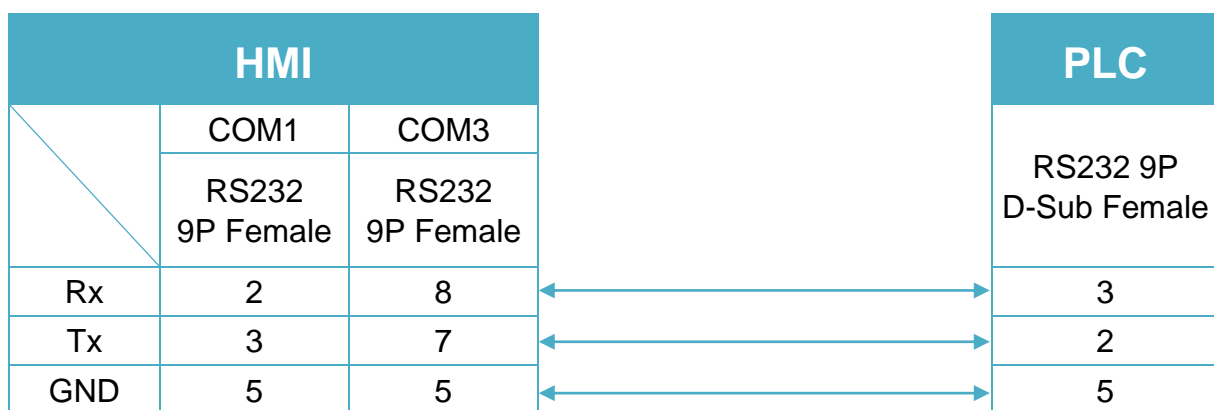


Diagram 2

cMT Series	cMT-SVR
mTV	mTV
MT-iE	MT8070iE / MT6070iE / MT8100iE / MT8121iE / MT8150iE / MT8071iE / MT6071iE / MT8072iE / MT6072iE / MT8073iE / MT8101iE / MT8102iE / MT8103iE
MT-XE	MT8121XE / MT8150XE / MT8090XE

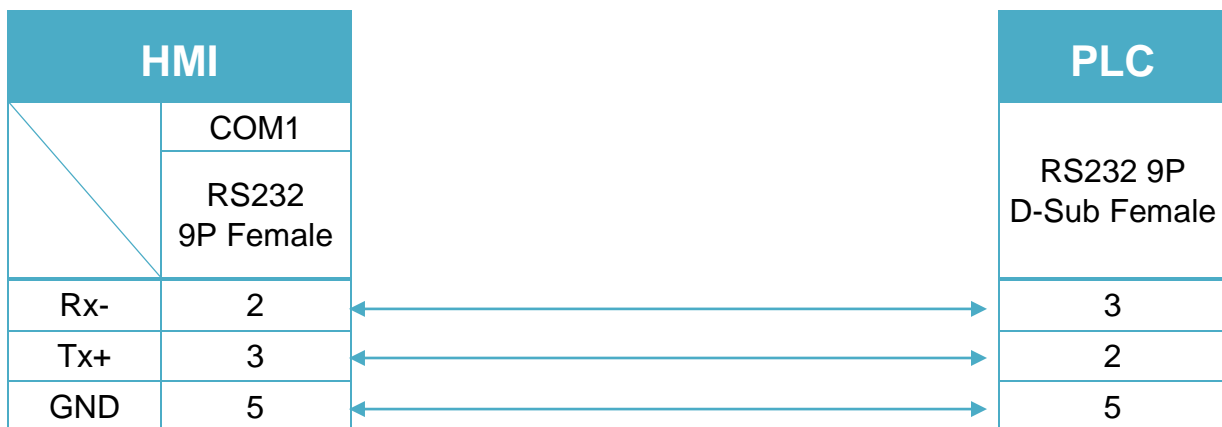


Diagram 3

MT-iE	MT8050iE
MT-iP	MT6051iP / MT6071iP / MT8071iP

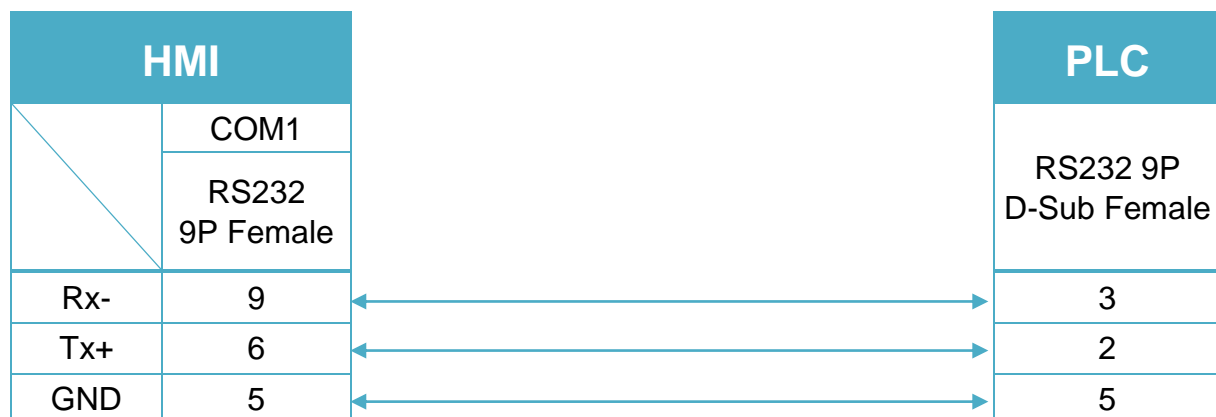


Diagram 4

Etehernet cable:



SAIA PCD PGU Mode

Supported Series : SAIA PCD series PGU mode.

Website : <http://www.saia-burgess.com/>

HMI Setting:

Parameters	Recommended	Options	Notes
PLC type	SAIA PCD PGU Mode		PDS driver
PLC I/F	RS232	RS232, RS485	
Baud rate	9600	9600, 19200	
Data bits	7	7,8	
Parity	Even	Even, Odd, None	
Stop bits	1	1	
PLC sta. no.	1	0-255	

Device Address:

Bit/Word	Device type	Format	Range	Memo
B	Flag	DDDD	0 ~ 8191	
B	Output	DDD	0 ~ 511	
B	Input	DDD	0 ~ 511	
W	Register	DDDD	0 ~ 4095	
W	Counter	DDDD	0 ~ 1599	
W	Timer	DDDD	0 ~ 1599	
W	Reg_Float	DDDD	0 ~ 4095	support single float point
W	Reg_Word	DDDD	0 ~ 4095	

Wiring Diagram:

Diagram 1

cMT Series	<i>cMT3151</i>
eMT Series	<i>eMT3070 / eMT3105 / eMT3120 / eMT3150</i>
MT-iE	<i>MT8070iE / MT6070iE / MT8100iE / MT8121iE / MT8150iE / MT8071iE / MT6071iE / MT8072iE / MT6072iE / MT8073iE / MT8101iE / MT8102iE / MT8103iE</i>
MT-XE	<i>MT8121XE / MT8150XE / MT8090XE / MT8092XE</i>
MT-iP	<i>MT6103iP</i>

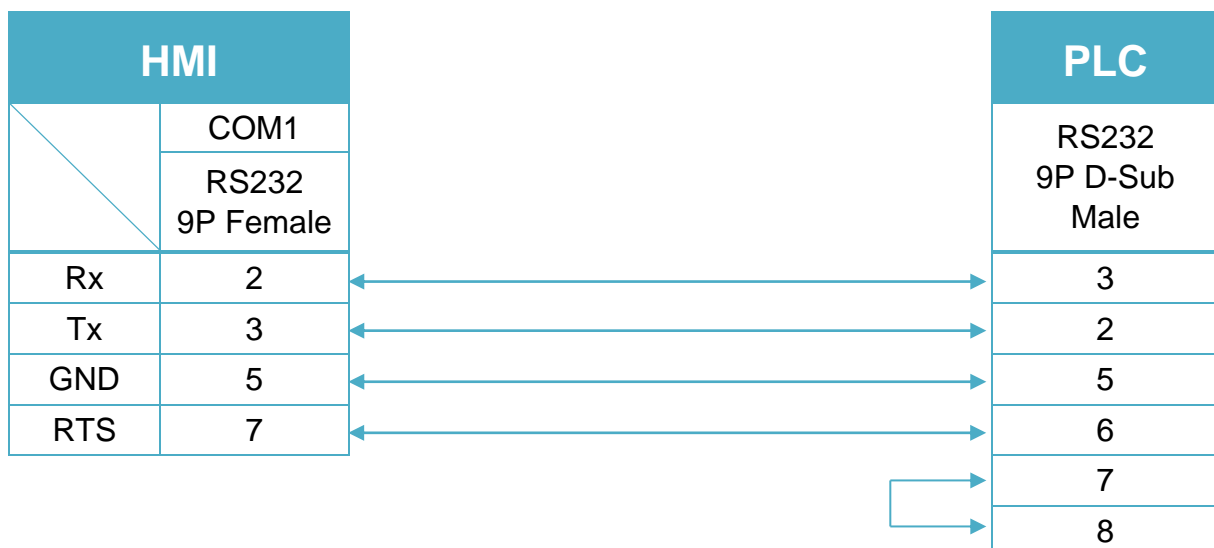
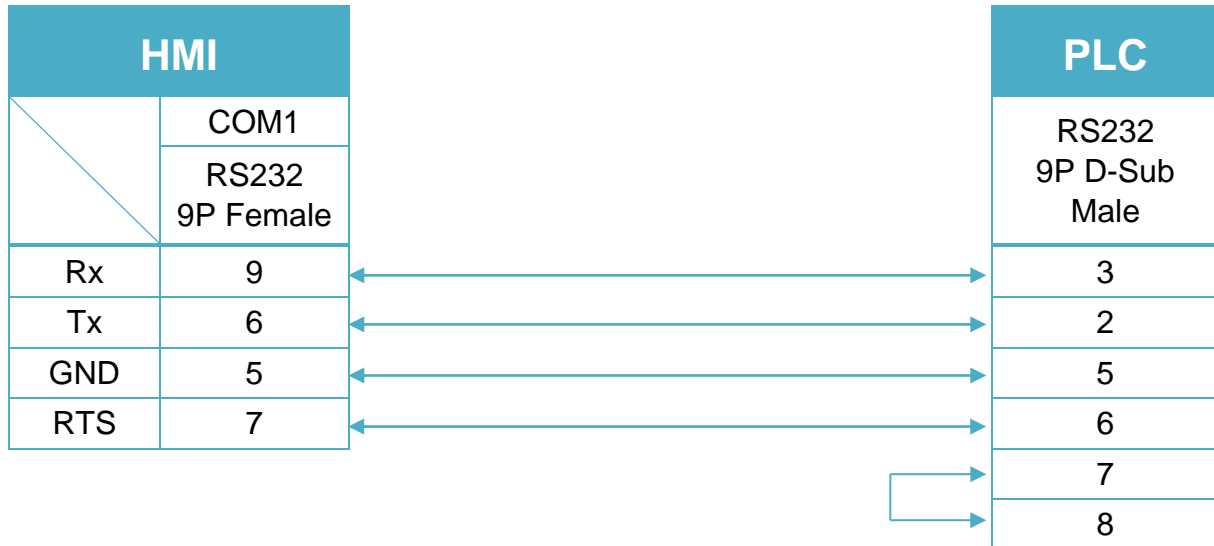


Diagram 2

MT-iP
MT6071iP / MT8071iP


6 DSR (Of PGU Port): PGU connected.

SAIA PCD S-BUS Mode

Supported Series: SAIA PCD series S-Bus mode.

Website: <http://www.saia-burgess.com/>

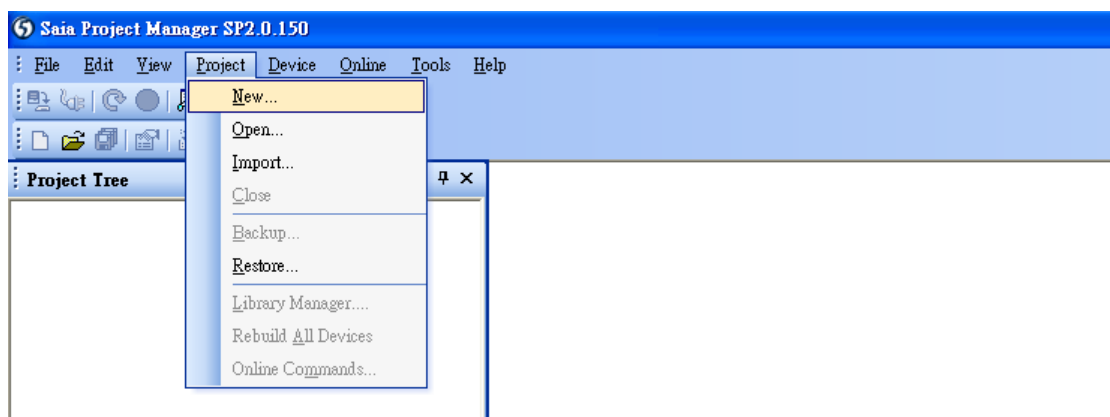
HMI Setting:

Parameters	Recommended	Options	Notes
PLC type	SAIA PCD S-BUS Mode		PDS driver
PLC I/F	RS232	RS232, RS485	
Baud rate	9600	9600, 19200, 38400	
Data bits	8	7,8	
Parity	None	Even, Odd, None	
Stop bits	1	1	
PLC sta.	0	0-255	

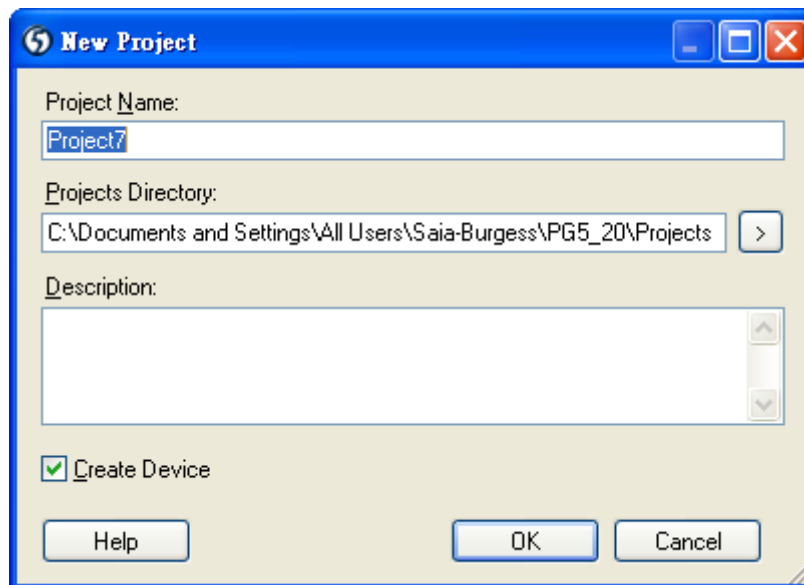
PLC Setting:

Communication mode	9600,N,8,1 (default)
RS232	Port 0-Type: RS232
RS485 2W	S-BUS Mode: Data(S2), Port 1-Type: RS485

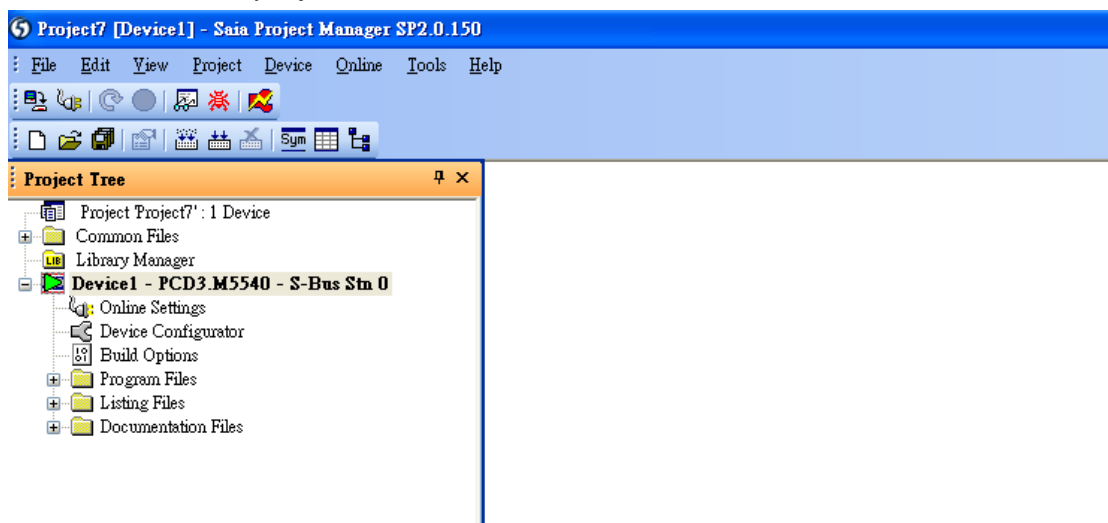
1. Open Saia Project Manager SP2.0.150 and create a new project.



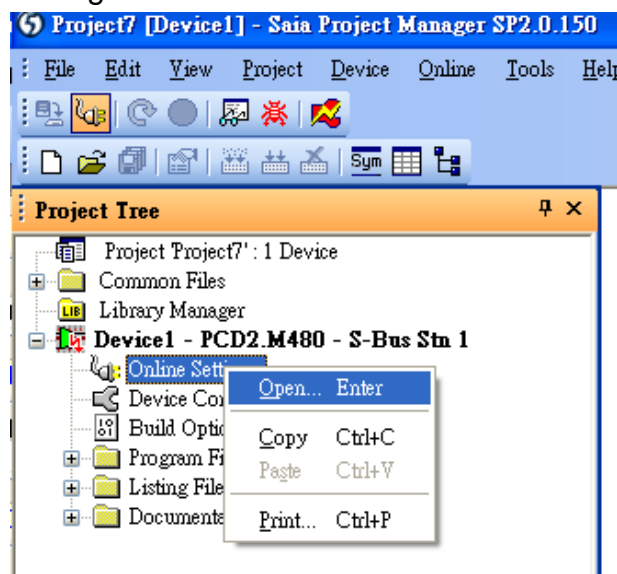
2. Give a project name.



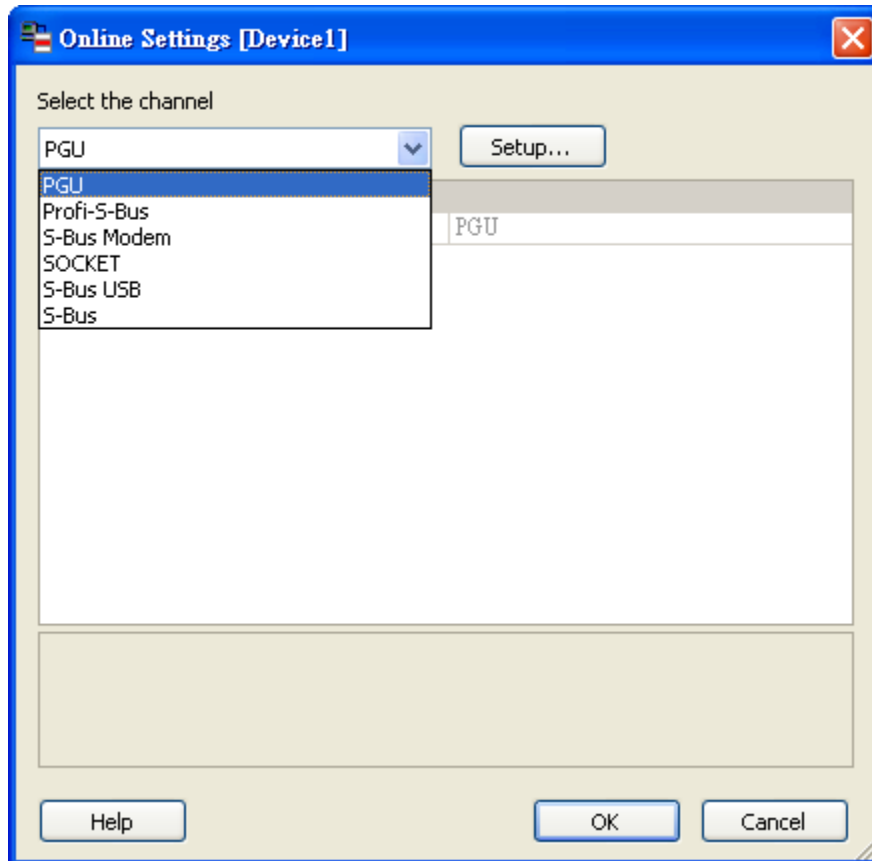
3. Create a new project as below.



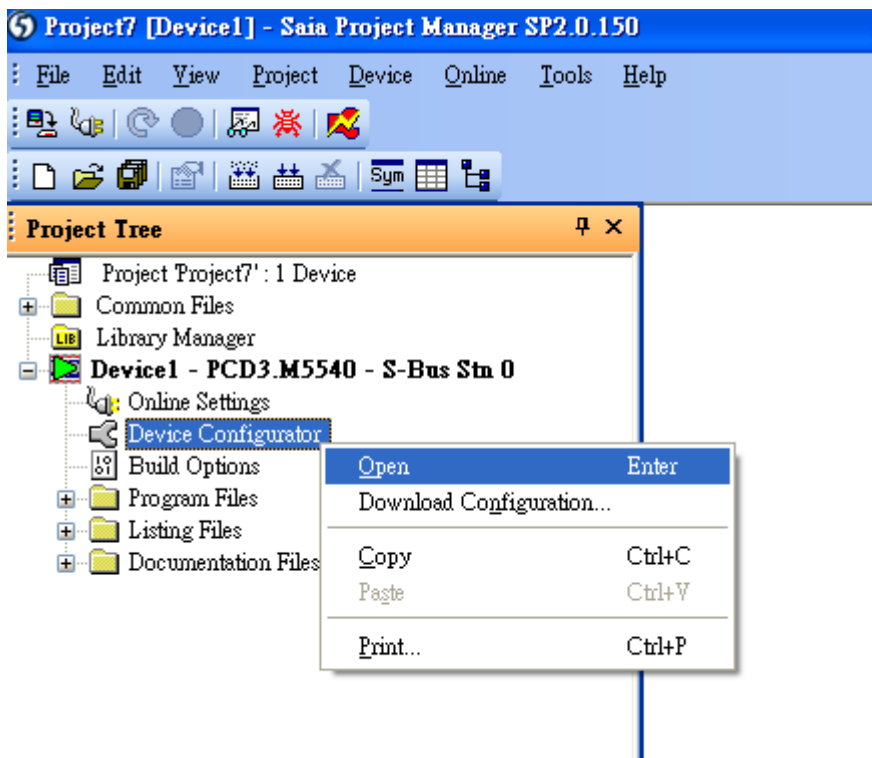
4. Go to "Online Setting".



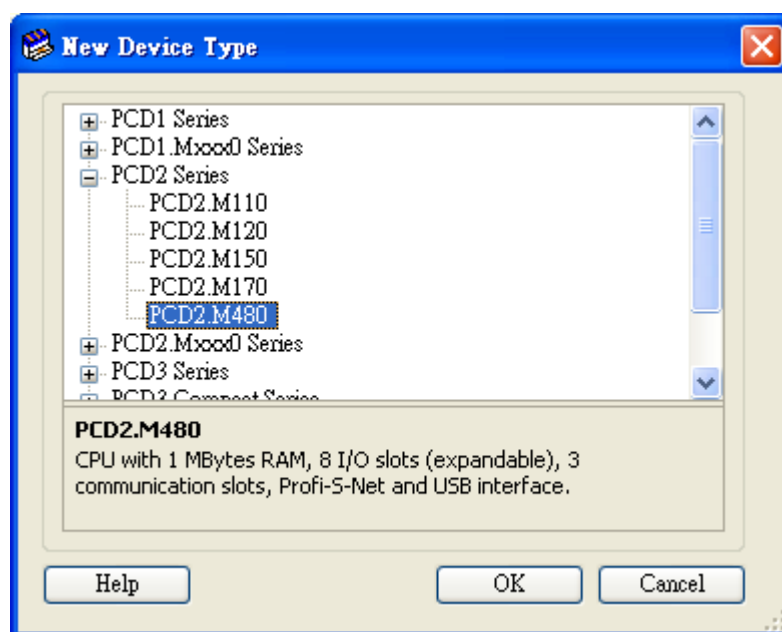
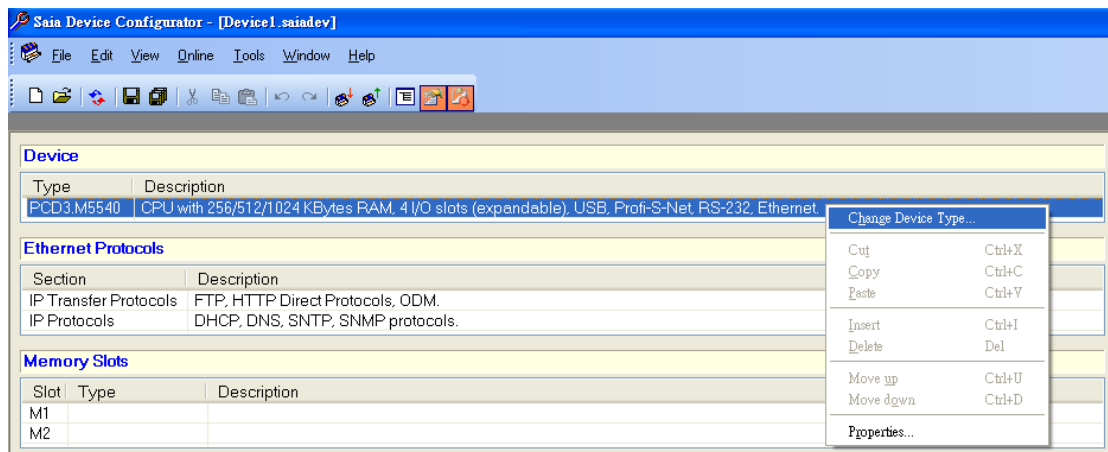
5. Select "PGU".



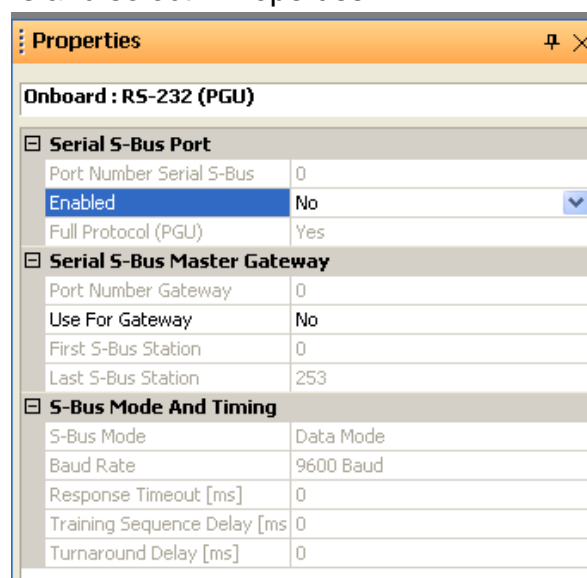
6. Go to "Device Configurator".



- Click "Change Device Type" to select your PLC model.



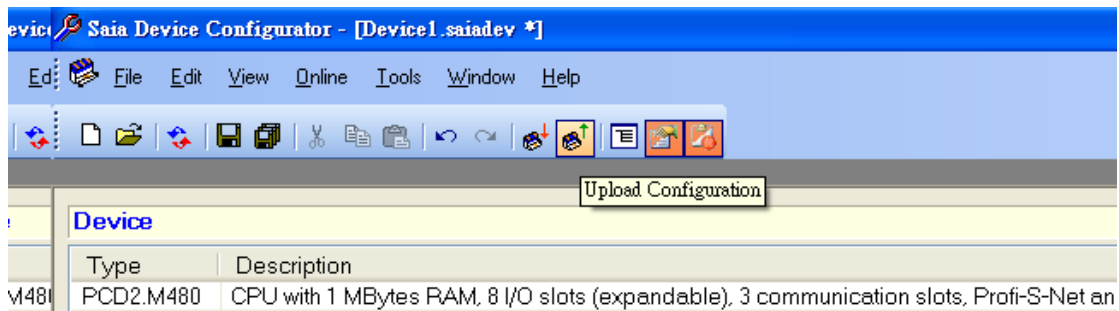
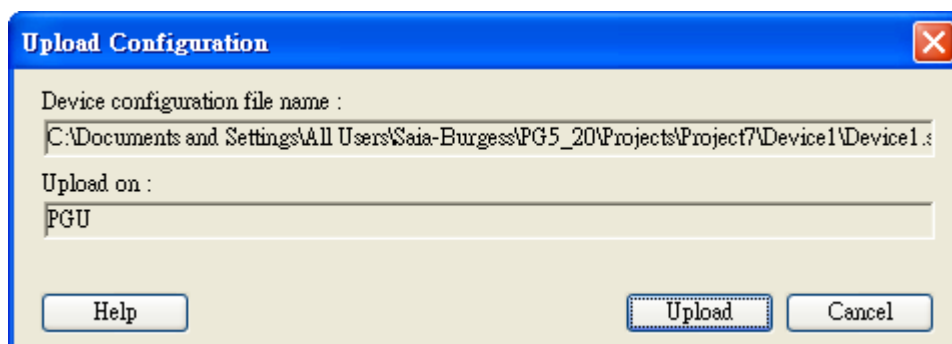
- Select RS232 (PGU) in Type and then right click mouse on Onboard Communications and select "Properties".



9. Select "Yes" in Series S-Bus Port: Enabled.

Properties		
Onboard : RS-232 (PGU)		
Serial S-Bus Port		
Port Number Serial S-Bus	0	
Enabled	Yes	
Full Protocol (PGU)	Yes	
Serial S-Bus Master Gateway		
Port Number Gateway	0	
Use For Gateway	No	
First S-Bus Station	0	
Last S-Bus Station	253	
S-Bus Mode And Timing		
S-Bus Mode	Data Mode	
Baud Rate	9600 Baud	
Response Timeout [ms]	0	
Training Sequence Delay [ms]	0	
Turnaround Delay [ms]	0	

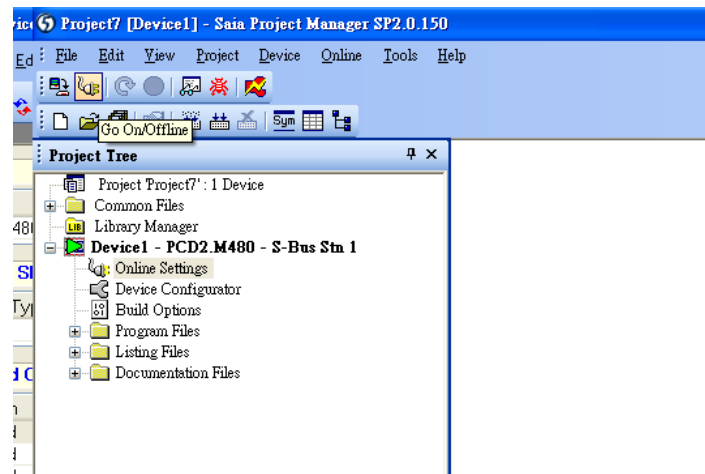
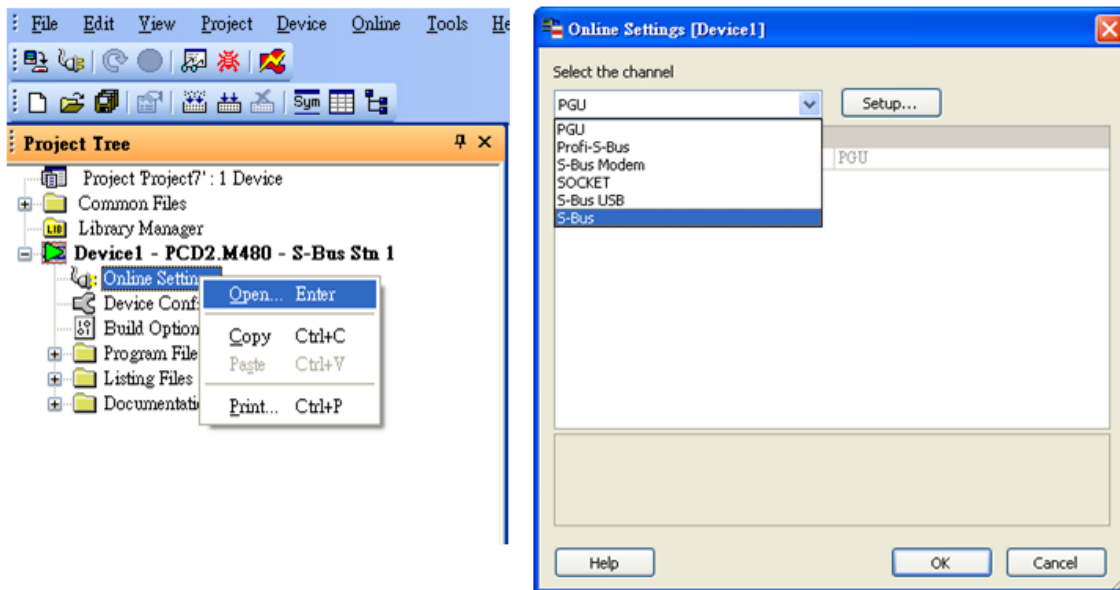
10. Set parameters in S-Bus Mode and Timing then upload to PLC.

The 'Upload Configuration' dialog box is shown with the following fields and buttons:

- Device configuration file name :** C:\Documents and Settings\All Users\Saia-Burgess\PG5_20\Projects\Project7\Device1\Device1.s
- Upload on :** PGU
- Buttons: Help, Upload, Cancel

11. Go to Online Settings >> Open to select S-Bus for finishing the PLC settings.



Device Address:

Bit/Word	Device type	Format	Range	Memo
B	Flag	DDDD	0 ~ 8191	
B	Output	DDDD	0 ~ 1023	
B	Input	DDDD	0 ~ 1023	
B	Reg_Bit	DDDDdd	0 ~ 1638331	dd: Bit no. (00~31)
DW	Register	DDDDD	0 ~ 16383	
DW	Counter	DDDD	0 ~ 1599	
DW	Timer	DDDD	0 ~ 1599	
DW	Reg_Float	DDDDD	0 ~ 16383	support single float point
DW	DBn	DDDDDDDD	0 ~ 536016383	

Wiring Diagram:

SAIA PCD PGU Port RS232 9P D-Sub (Diagram 1 ~ Diagram 3)

Diagram 1

cMT Series	<i>cMT3151</i>
eMT Series	<i>eMT3070 / eMT3105 / eMT3120 / eMT3150</i>
MT-iE	<i>MT8073iE / MT8102iE</i>
MT-XE	<i>MT8092XE</i>
MT-iP	<i>MT6103iP</i>

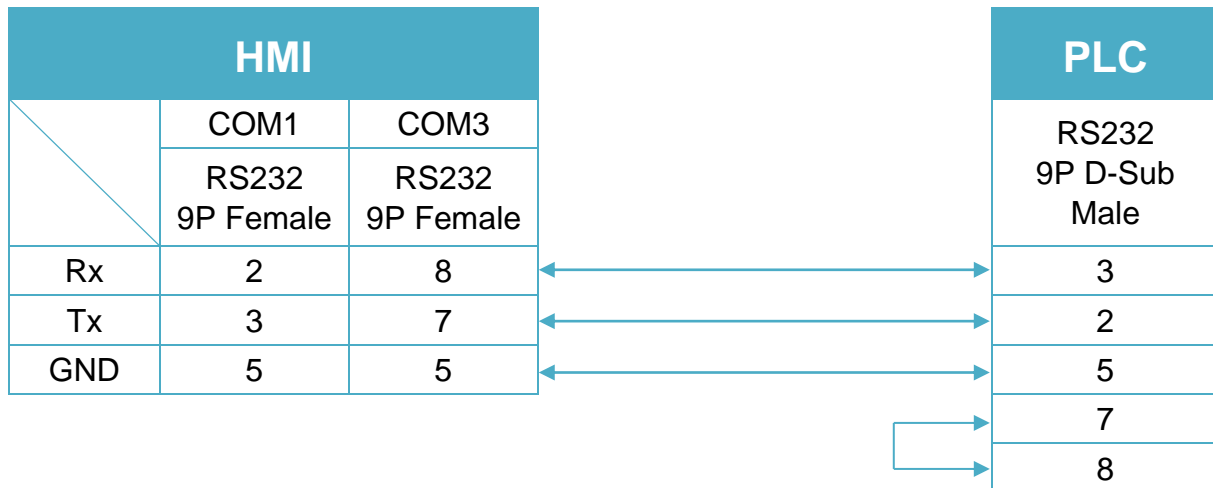


Diagram 2

cMT Series	<i>cMT-SVR</i>
mTV	<i>mTV</i>
MT-iE	<i>MT8070iE / MT6070iE / MT8100iE / MT8121iE / MT8150iE / MT8071iE / MT6071iE / MT8072iE / MT6072iE / MT8073iE / MT8101iE / MT8102iE / MT8103iE</i>
MT-XE	<i>MT8121XE / MT8150XE / MT8090XE</i>

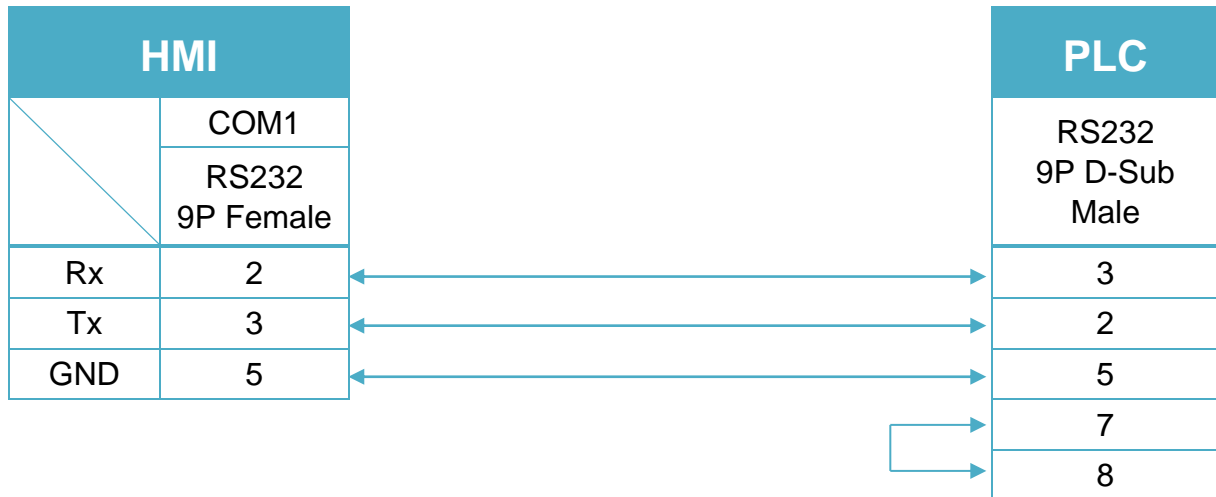
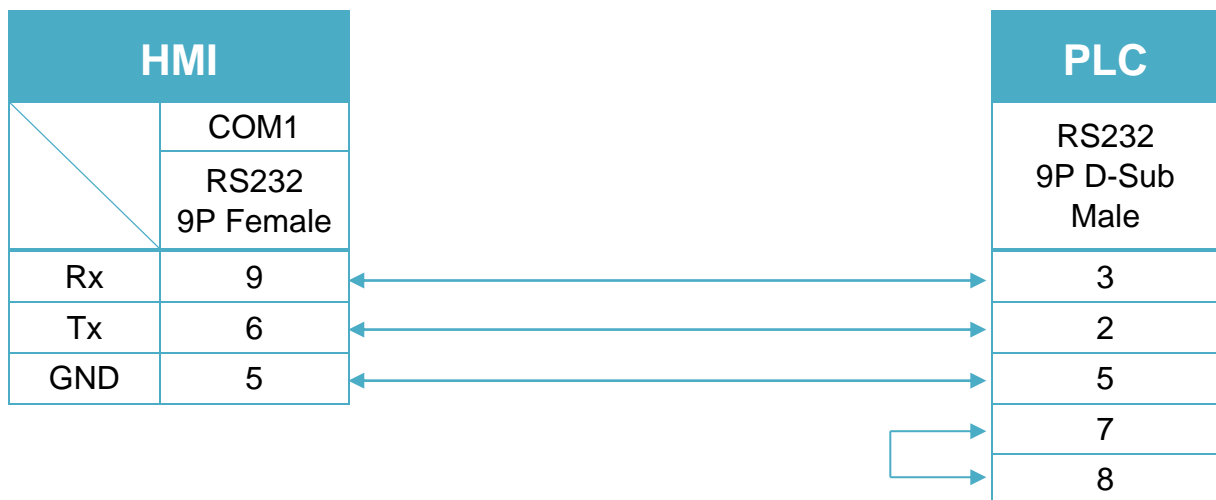


Diagram 3

MT-iE *MT8050iE*

MT-iP *MT6051iP / MT6071iP / MT8071iP*



SAIA PCD1 Port #1 (Port #0) Terminal (Diagram 4 ~ Diagram 9)

Diagram 4

cMT Series *cMT3151*

eMT Series *eMT3070/ eMT3105 / eMT3120 / eMT3150*

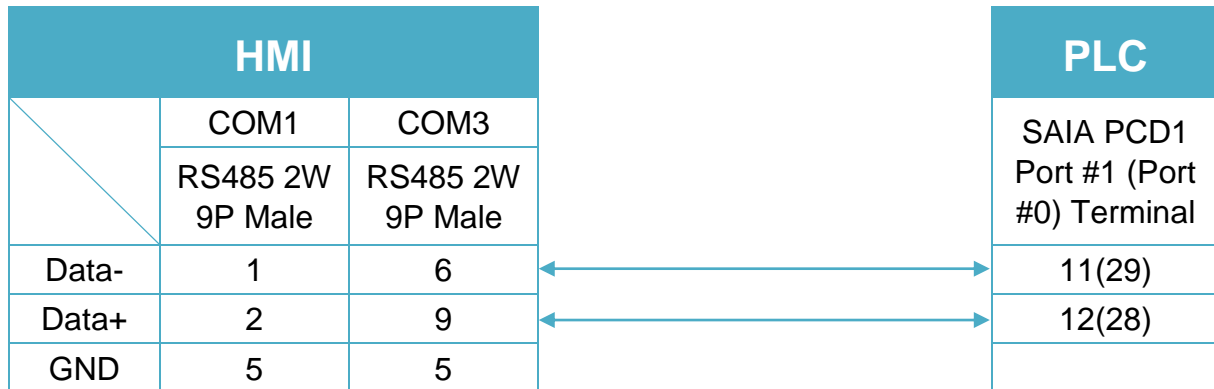


Diagram 5

cMT Series *cMT-SVR*

mTV *mTV*

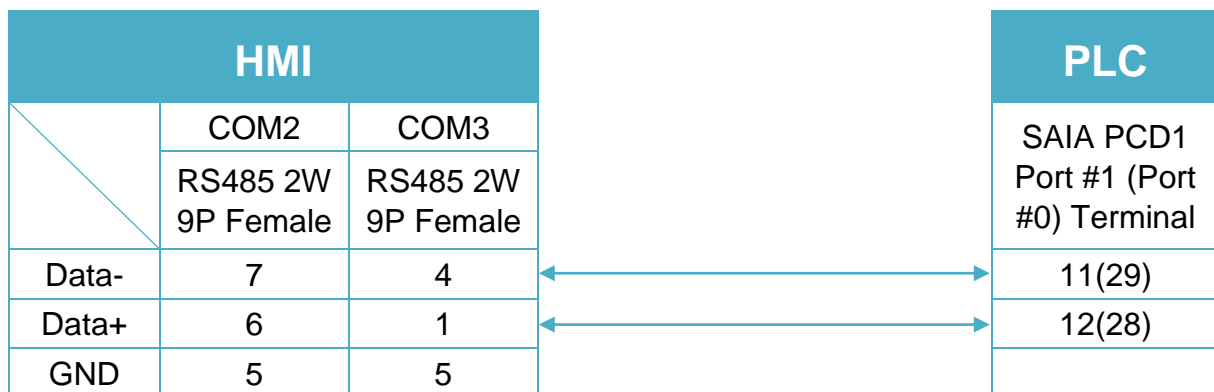


Diagram 6

MT-iE *MT8070iE / MT6070iE / MT8100iE / MT8121iE / MT8150iE*

MT-XE *MT8121XE / MT8150XE*

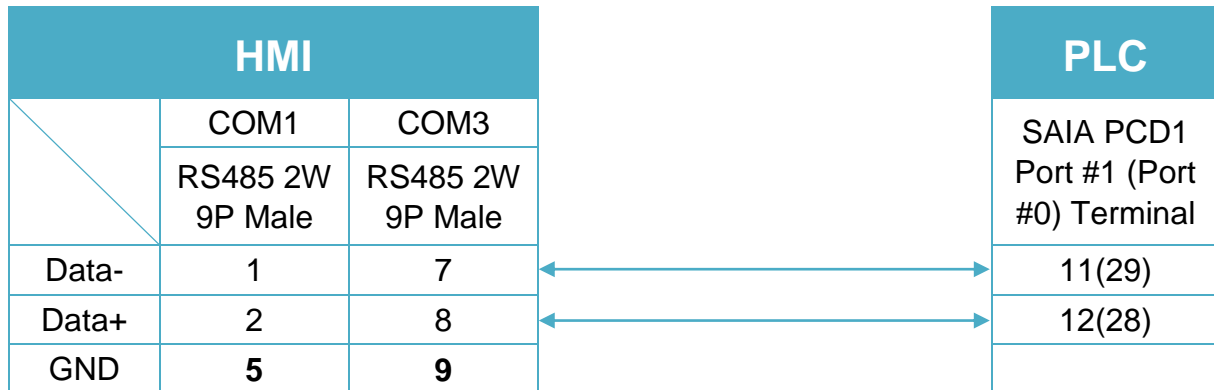


Diagram 7

MT-iE *MT8071iE / MT6071iE / MT8072iE / MT6072iE / MT8073iE /
MT8101iE / MT8102iE / MT8103iE*

MT-XE *MT8090XE / MT8092XE*

MT-iP *MT6103iP*

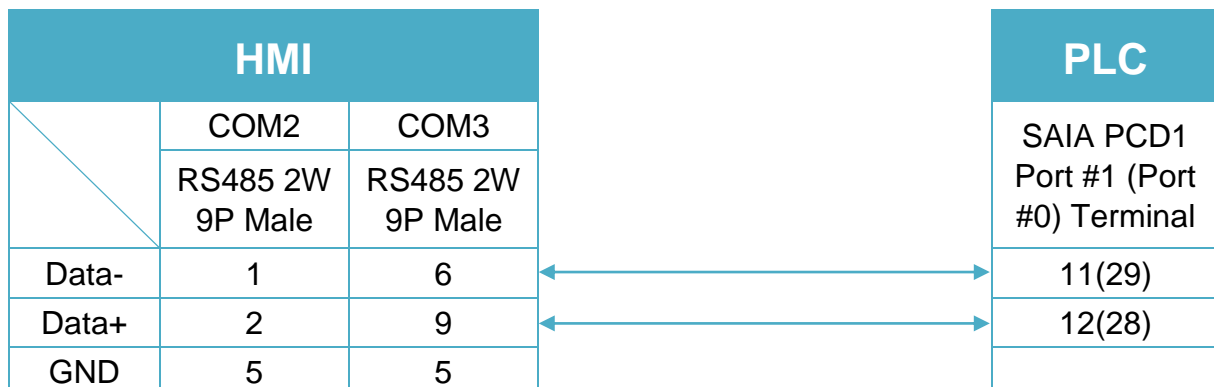
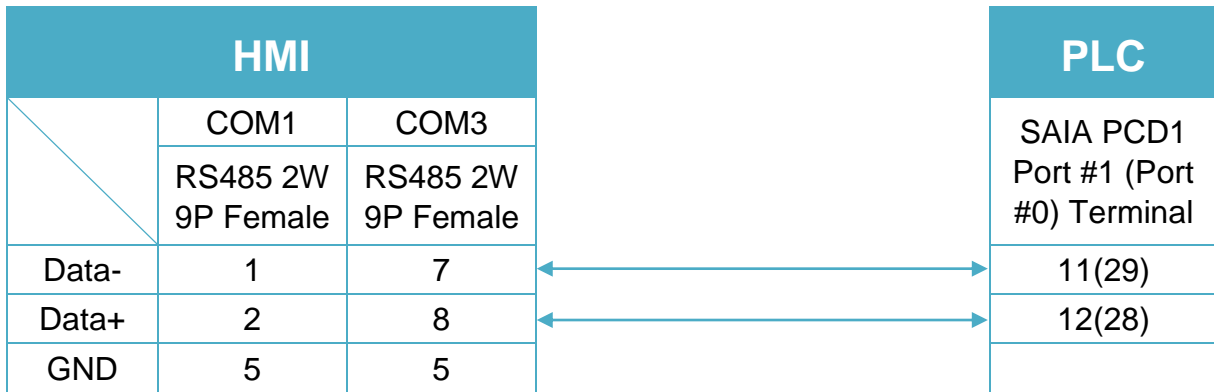
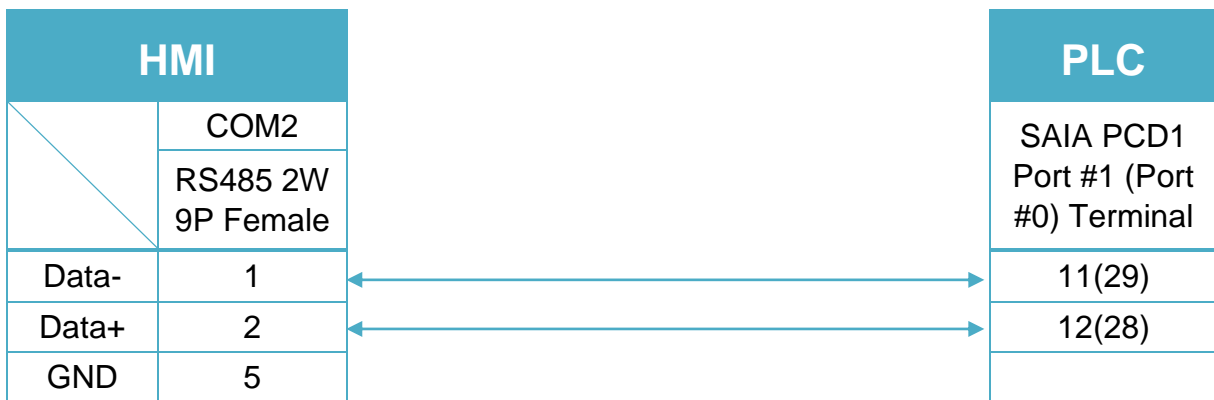


Diagram 8
MT-iE *MT8050iE*
MT-iP *MT6051iP*

Diagram 9
MT-iP *MT6071iP / MT8071iP*


SAIA S-BUS (Ethernet)

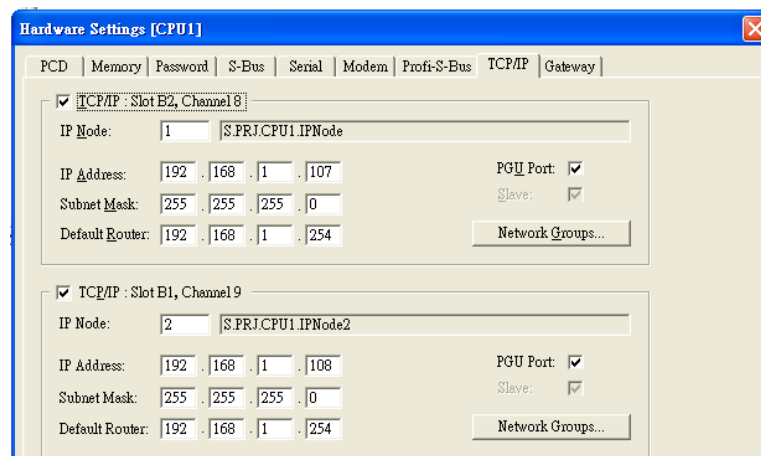
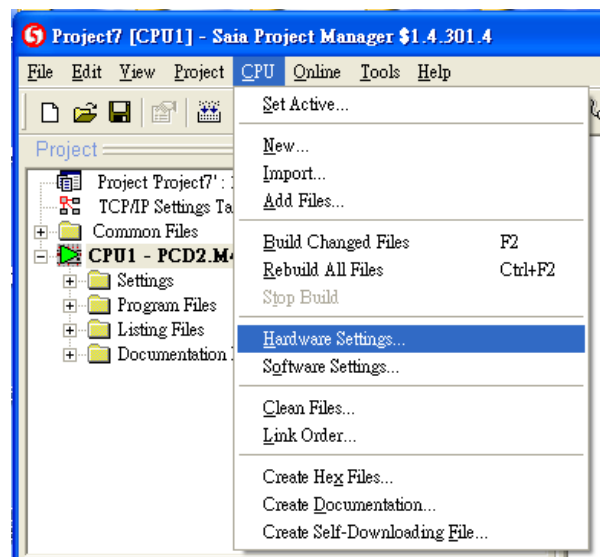
Supported Series : SAIA PCD series Ethernet-TCP/IP.

Website : <http://www.saia-burgess.com/>

HMI Setting:

Parameters	Recommended	Options	Notes
PLC type	SAIA S-BUS (Ethernet)		
PLC I/F	Ethernet		
Port no.	5050		
PLC sta. no.	0		

PLC Setting:



Device Address:

Bit/Word	Device type	Format	Range	Memo
B	Flag	DDDD	0 ~ 8191	
B	Output	DDDD	0 ~ 1023	
B	Input	DDDD	0 ~ 1023	
B	Reg_Bit	DDDDdd	0 ~ 1638331	dd: Bit no. (00 ~ 31)
B	DBn_Bit	DDDDDDDDdd	0 ~ 399938331	
DW	Register	DDDDD	0 ~ 16383	
DW	Counter	DDDD	0 ~ 1599	
DW	Timer	DDDD	0 ~ 1599	
DW	Reg_Float	DDDDD	0 ~ 16383	support single float point
DW	DBn	DDDDDDDDD	0 ~ 536016383	
DW	DB_String	DDDDDDDDD	0 ~ 536016383	
DW	R_String	DDDDD	0 ~ 16383	
DW	DB_Float	DDDDDDDDD	0 ~ 536016383	

Wiring Diagram:

Ethernet cable:



Samsung SPC-10

Supported Series: Samsung SPC-10

Website: http://www.samsungelectronics.com/factory_automation/controller/plc/

HMI Setting:

Parameters	Recommended	Options	Notes
PLC type	Samsung SPC-10		
PLC I/F	RS485 2W		
Baud rate	9600		
Data bits	None		
Parity	8		
Stop bits	1		
PLC sta. no.	192		

Device Address:

Bit/Word	Device type	Format	Range	Memo
B	R	DDDDdd	0 ~ 999915	
B	K	DDDDdd	0 ~ 999915	
B	M	DDDDdd	0 ~ 999915	
B	F	DDDDdd	0 ~ 999915	
W	W	DDDD	0 ~ 9999	

Wiring Diagram:

The following is the view from the soldering point of a cable.



Diagram 1

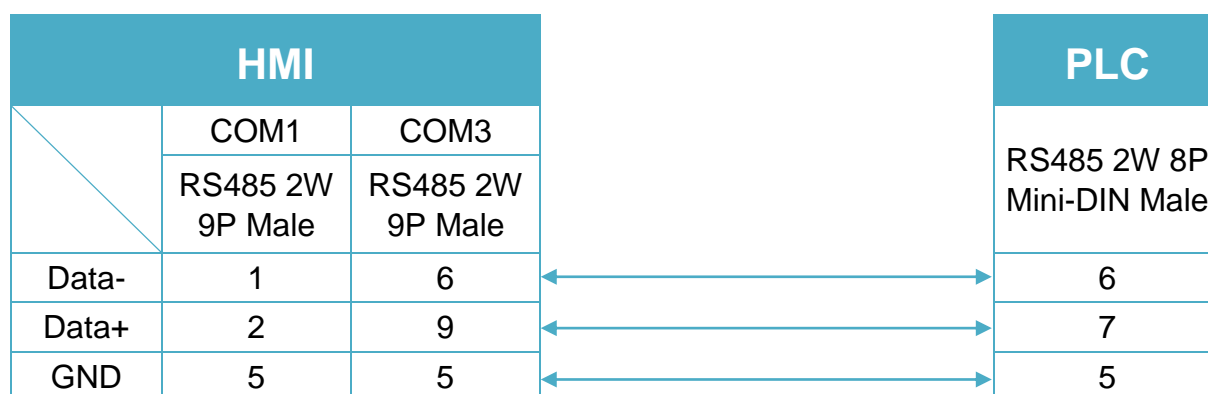
cMT Series
cMT3151
eMT Series
eMT3070 / eMT3105 / eMT3120 / eMT3150


Diagram 2

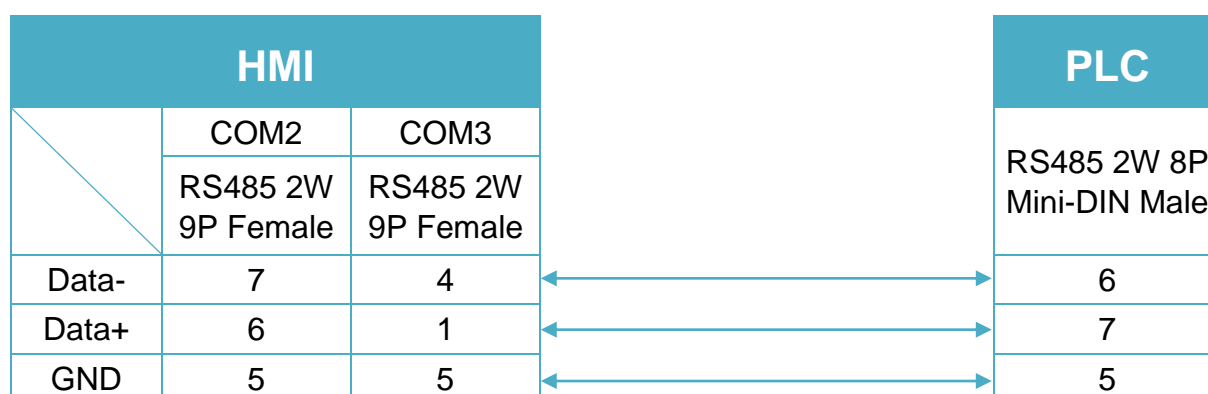
cMT Series
cMT-SVR
mTV
mTV


Diagram 3

MT-iE *MT8070iE / MT6070iE / MT8100iE / MT8121iE / MT8150iE*

MT-XE *MT8121XE / MT8150XE*

HMI				PLC
	COM1	COM3		RS485 2W 8P Mini-DIN Male
	RS485 2W 9P Male	RS485 2W 9P Male		
Data-	1	7	←→	6
Data+	2	8	←→	7
GND	5	9	←→	5

Diagram 4

MT-iE *MT8071iE / MT6071iE / MT8072iE / MT6072iE / MT8073iE /
MT8101iE / MT8102iE / MT8103iE*

MT-XE *MT8090XE / MT8092XE*

MT-iP *MT6103iP*

HMI				PLC
	COM2	COM3		RS485 2W 8P Mini-DIN Male
	RS485 2W 9P Male	RS485 2W 9P Male		
Data-	1	6	←→	6
Data+	2	9	←→	7
GND	5	5	←→	5

Diagram 5

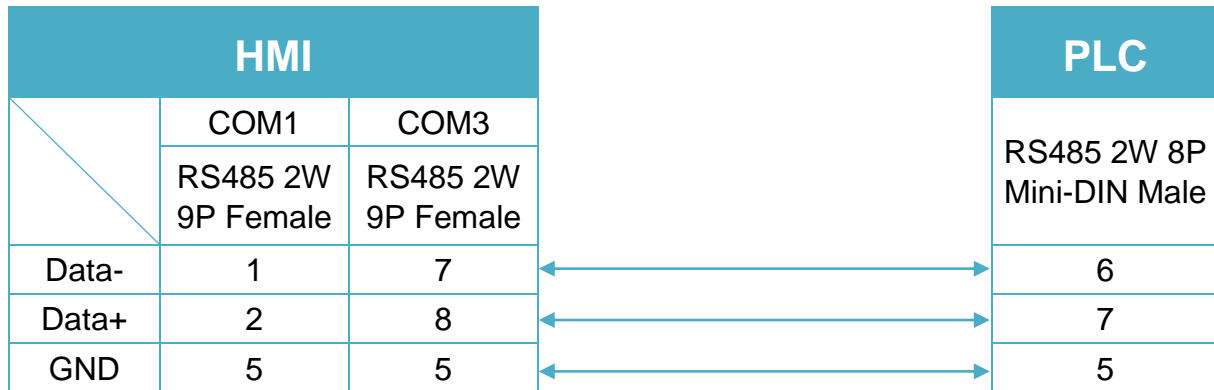
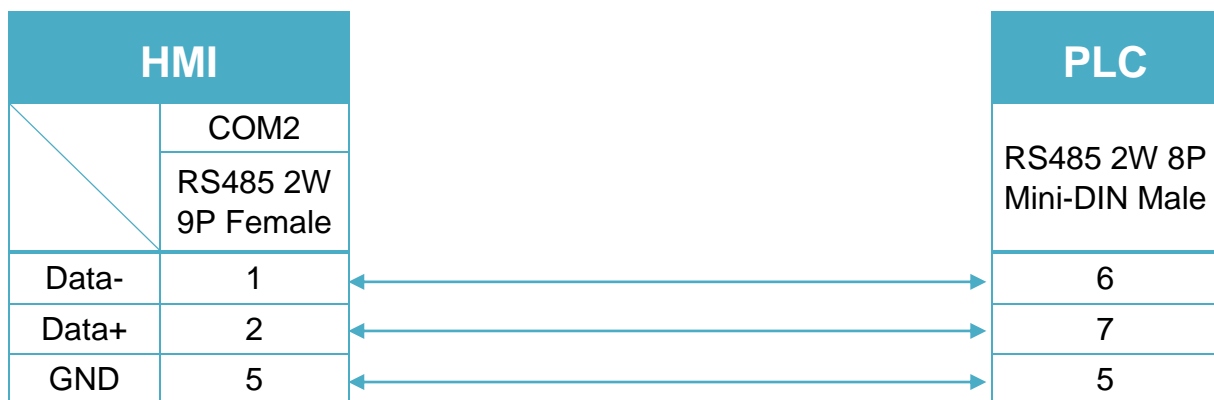
MT-iE *MT8050iE*
MT-iP *MT6051iP*


Diagram 6

MT-iP *MT6071iP / MT8071iP*


SCENE6 Controller

HMI Setting:

Parameters	Recommended	Options	Notes
PLC type	SCENE6 Controller		
PLC I/F	RS232		
Baud rate	9600		
Data bits	8		
Parity	None		
Stop bits	2		
PLC sta. no.	0		

Device Address:

Bit/Word	Device type	Format	Range	Memo
W	Word	DD	0 ~ 99	

Wiring Diagram:

Diagram 1

cMT Series	<i>cMT3151</i>
eMT Series	<i>eMT3070 / eMT3105 / eMT3120 / eMT3150</i>
MT-iE	<i>MT8073iE / MT8102iE</i>
MT-XE	<i>MT8092XE</i>
MT-iP	<i>MT6103iP</i>

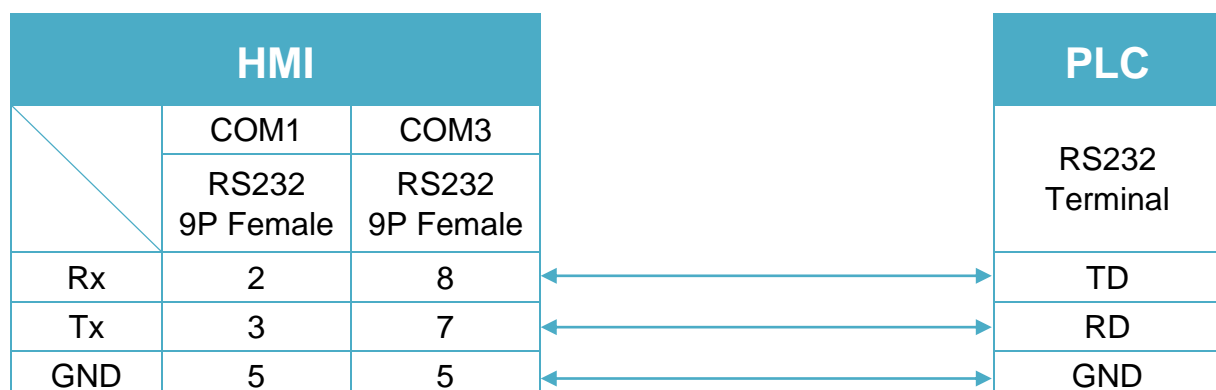


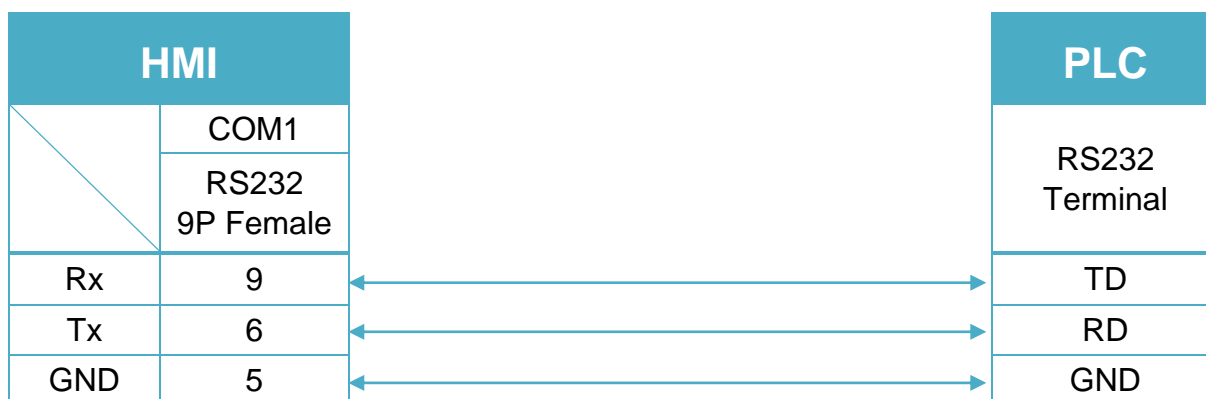
Diagram 2

cMT Series	cMT-SVR
mTV	mTV
MT-iE	MT8070iE / MT6070iE / MT8100iE / MT8121iE / MT8150iE / MT8071iE / MT6071iE / MT8072iE / MT6072iE / MT8073iE / MT8101iE / MT8102iE / MT8103iE
MT-XE	MT8121XE / MT8150XE / MT8090XE



Diagram 3

MT-iE	MT8050iE
MT-iP	MT6051iP / MT6071iP / MT8071iP



Schleicher XCS 20C

Supported Series: Schleicher XCx-Systems Ethernet port. Schleicher XCS series, 20C model.

Website: <http://www.schleicher-electronic.com>

HMI Setting:

Parameters	Recommended	Options	Notes
PLC type	Schleicher XCS 20C		
PLC I/F	RS232		
Baud rate	38400		
Data bits	8		
Parity	N		
Stop bits	1		
PLC sta. no.	0		

Device Address:

Bit/Word	Device type	Format	Range	Memo
B	IX	DDDDDo	0 ~ 655357	Input %IX
B	QX	DDDDDo	0 ~ 655357	Output %QX
B	MX	DDDDDo	0 ~ 655357	%MX
W	IW	DDDDD	0 ~ 65535	%IW
W	QW	DDDDD	0 ~ 65535	%QW
W	MW	DDDDD	0 ~ 65535	%MW
DW	ID	DDDDD	0 ~ 65535	%ID
DW	QD	DDDDD	0 ~ 65535	%QD
DW	MD	DDDDD	0 ~ 65535	%WD

- Word address must be even.

Wiring Diagram:

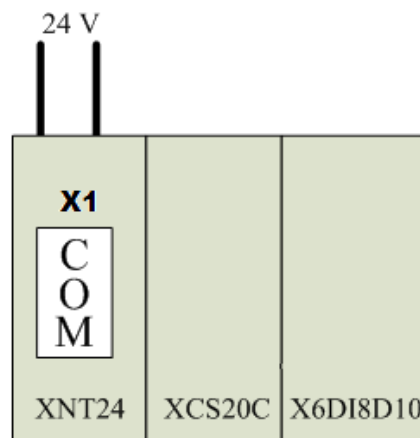


Diagram 1

cMT Series	<i>cMT3151</i>
eMT Series	<i>eMT3070 / eMT3105 / eMT3120 / eMT3150</i>
MT-iE	<i>MT8073iE / MT8102iE</i>
MT-XE	<i>MT8092XE</i>
MT-iP	<i>MT6103iP</i>

HMI			PLC
	COM1	COM3	Schleicher XCS20 RS232 9P D-Sub Male
	RS232 9P Female	RS232 9P Female	
Rx	2	8	3
Tx	3	7	2
GND	5	5	5

Diagram 2

cMT Series	cMT-SVR
mTV	mTV
MT-iE	MT8070iE / MT6070iE / MT8100iE / MT8121iE / MT8150iE / MT8071iE / MT6071iE / MT8072iE / MT6072iE / MT8073iE / MT8101iE / MT8102iE / MT8103iE
MT-XE	MT8121XE / MT8150XE / MT8090XE

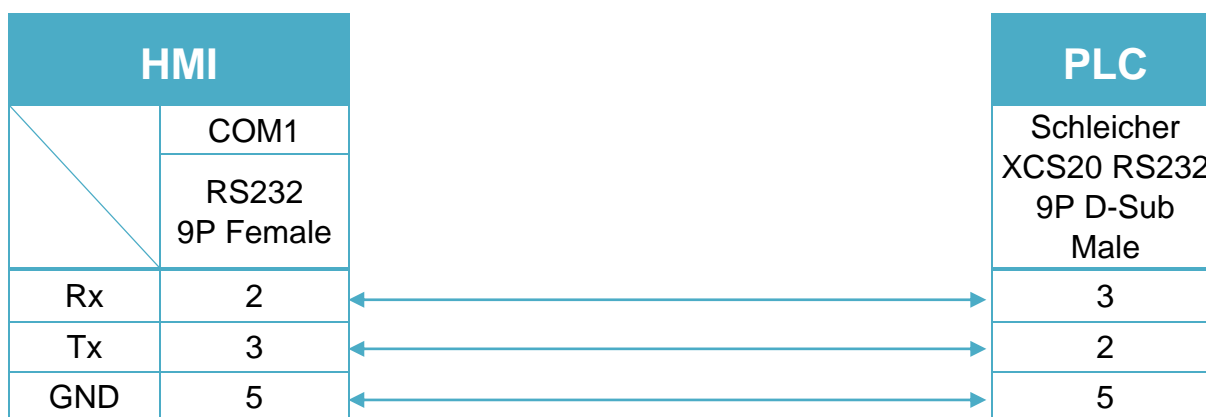
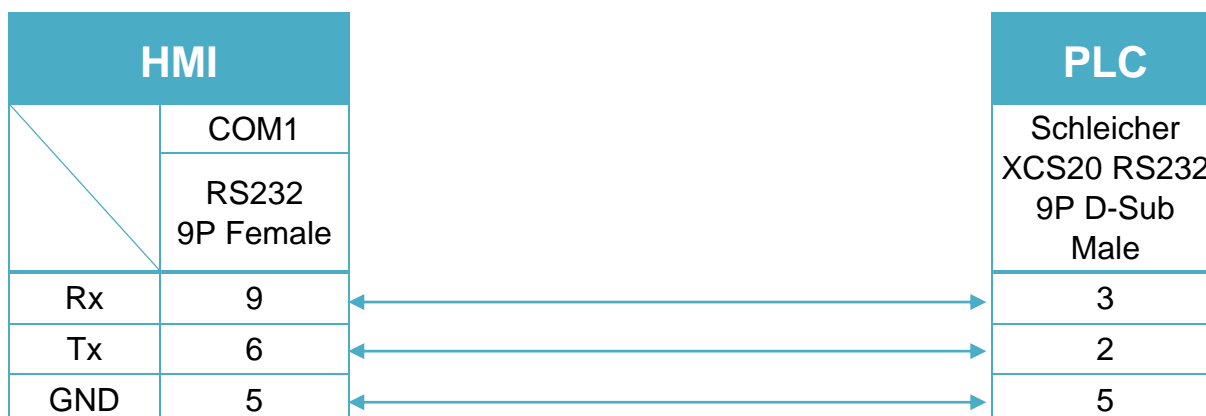


Diagram 3

MT-iE	MT8050iE
MT-iP	MT6051iP / MT6071iP / MT8071iP



Schleicher XCX 300

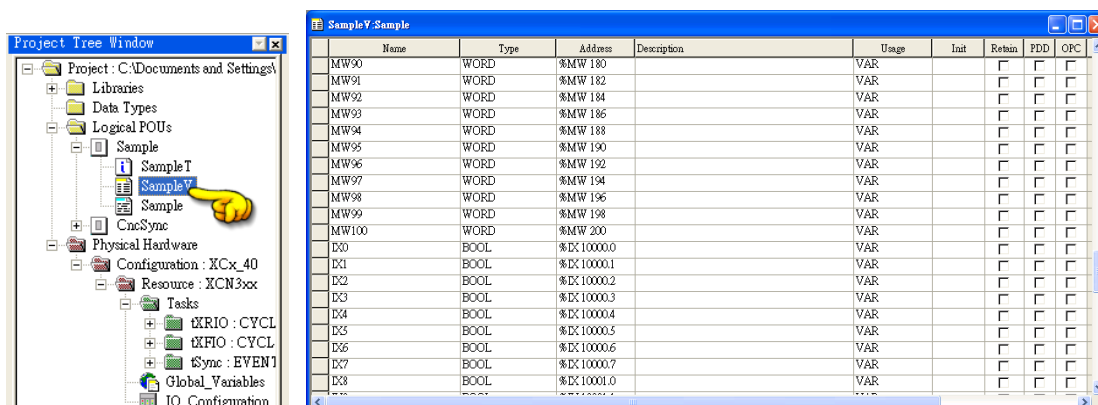
Website: <http://www.schleicher-electronic.com>

HMI Setting:

Parameters	Recommended	Options	Notes
PLC type	Schleicher XCX 300		
PLC I/F	Ethernet	RS232, RS422, Ethernet	
Port no.	20547		
PLC sta. no.	2		

PLC Setting:

A variable must be created for HMI access.



Device Address:

Bit/Word	Device type	Format	Range	Memo
B	IX	DDDDDo	0 ~ 65537	Input %IX
B	QX	DDDDDo	0 ~ 65537	Output %QX
B	MX	DDDDDo	0 ~ 65537	%MX
W	IW	DDDDD	0 ~ 65535	%IW
W	QW	DDDDD	0 ~ 65535	%QW
W	MW	DDDDD	0 ~ 65535	%MW
DW	ID	DDDDD	0 ~ 65535	%ID
DW	QD	DDDDD	0 ~ 65535	%QD
DW	MD	DDDDD	0 ~ 65535	%WD

- Word address must be even.

Wiring Diagram:

Diagram 1

Etehernet cable:



Schleicher XCX300 RS232 Port (Diagram 2 ~ Diagram 4)

Diagram 2

cMT Series	<i>cMT3151</i>
eMT Series	<i>eMT3070 / eMT3105 / eMT3120 / eMT3150</i>
MT-iE	<i>MT8073iE / MT8102iE</i>
MT-XE	<i>MT8092XE</i>
MT-iP	<i>MT6103iP</i>

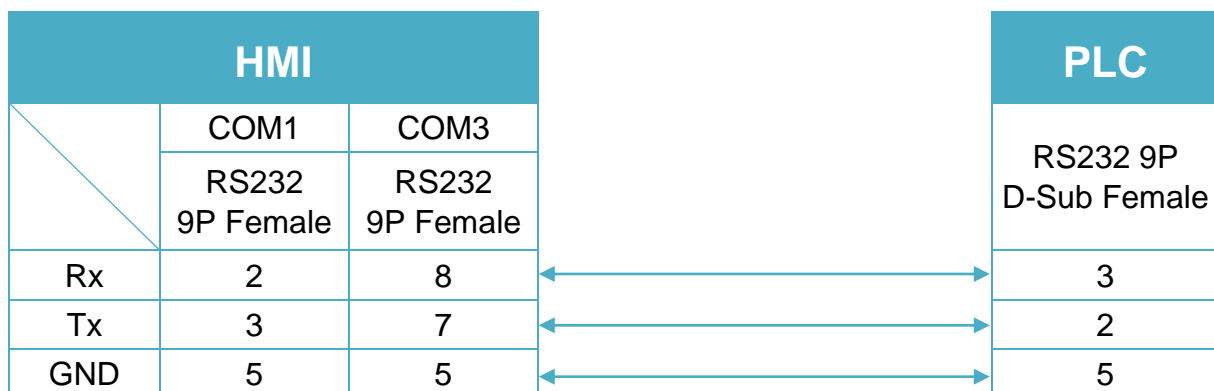


Diagram 3

cMT Series	cMT-SVR
mTV	mTV
MT-iE	MT8070iE / MT6070iE / MT8100iE / MT8121iE / MT8150iE / MT8071iE / MT6071iE / MT8072iE / MT6072iE / MT8073iE / MT8101iE / MT8102iE / MT8103iE
MT-XE	MT8121XE / MT8150XE / MT8090XE

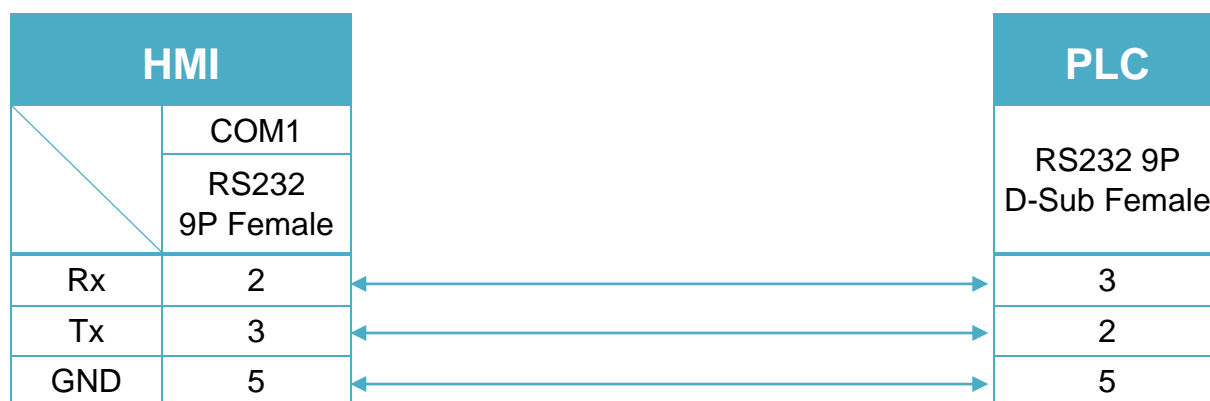
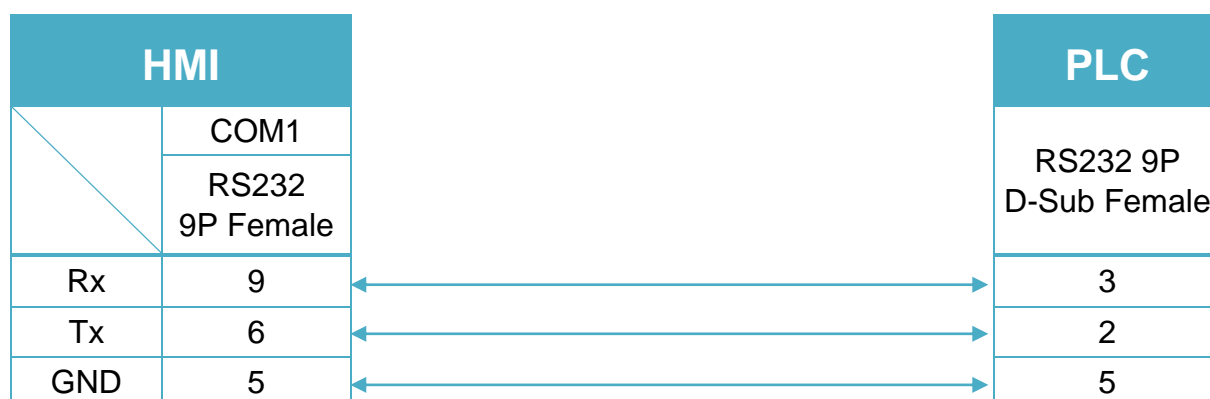


Diagram 4

MT-iE	MT8050iE
MT-iP	MT6051iP / MT6071iP / MT8071iP



Schleicher XCX300 RS485 4W Terminal (Diagram 5 ~ Diagram 8)

Diagram 5

cMT Series	<i>cMT3151</i>
eMT Series	<i>eMT3070 / eMT3105 / eMT3120 / eMT3150</i>
MT-iE	<i>MT8070iE / MT6070iE / MT8100iE / MT8121iE / MT8150iE</i>
MT-XE	<i>MT8121XE / MT8150XE</i>

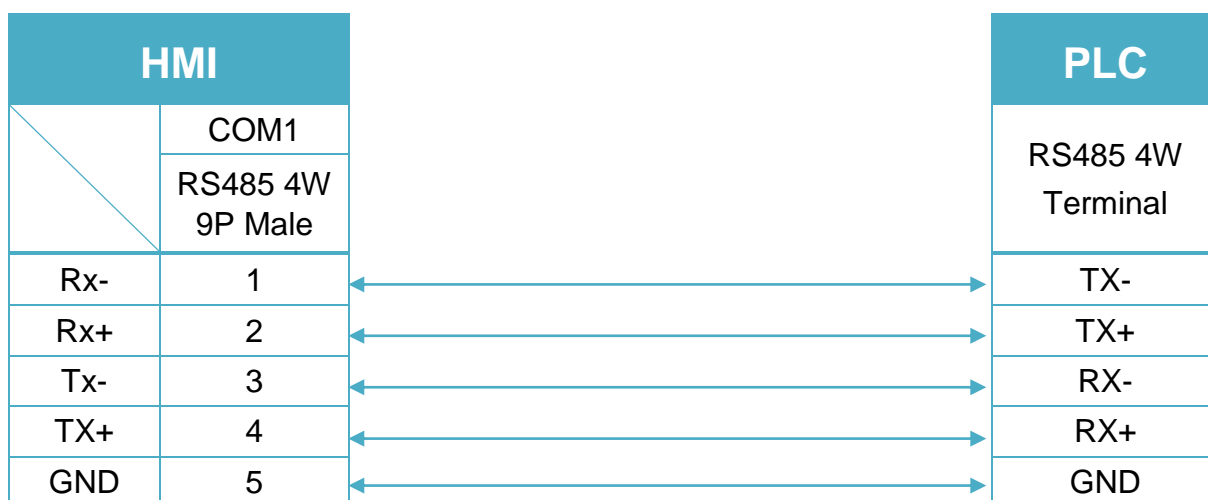


Diagram 6

cMT Series	<i>cMT-SVR</i>
mTV	<i>mTV</i>

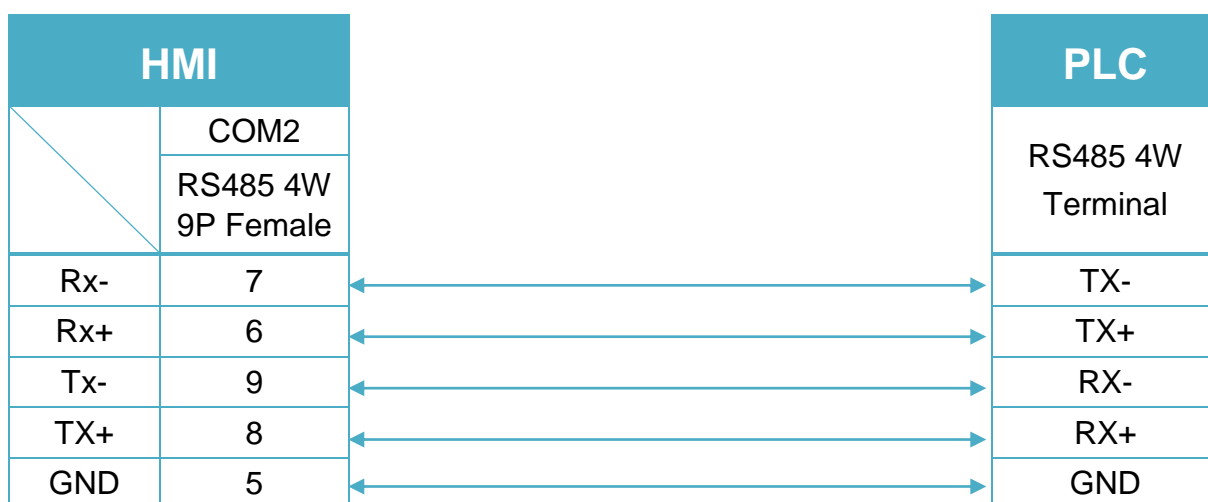


Diagram 7

MT-iE	<i>MT8071iE / MT6071iE / MT8072iE / MT6072iE / MT8073iE / MT8101iE / MT8102iE / MT8103iE</i>
MT-XE	<i>MT8090XE / MT8092XE</i>
MT-iP	<i>MT6071iP / MT8071iP / MT6103iP</i>

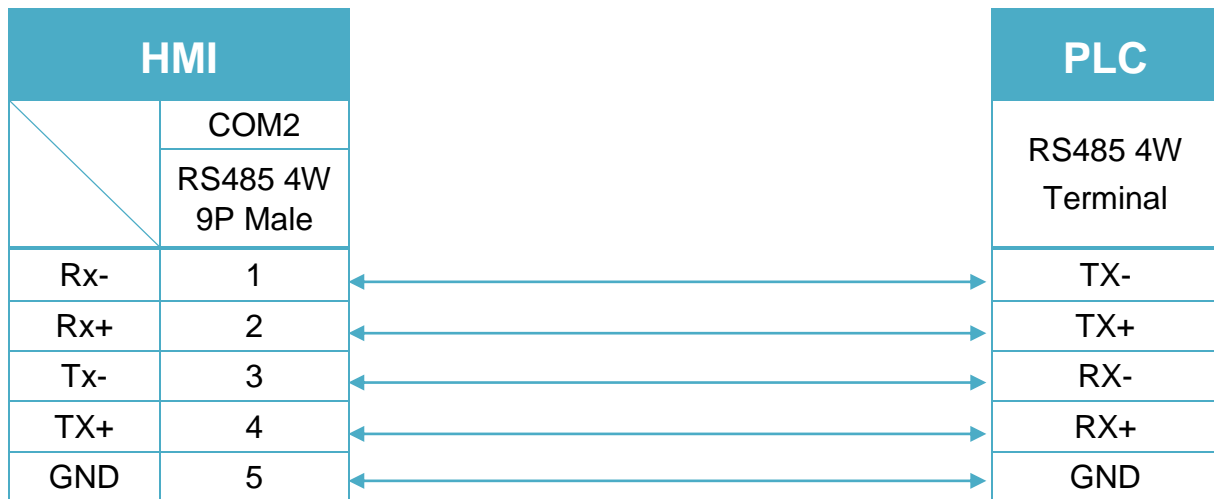
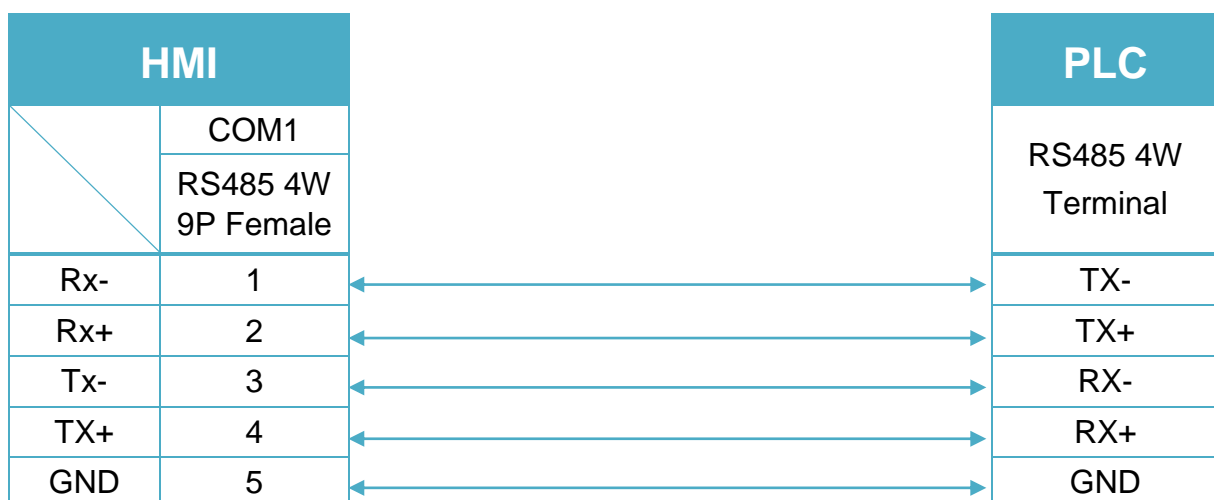


Diagram 8

MT-iE	<i>MT8050iE</i>
MT-iP	<i>MT6051iP</i>



Schneider IMS MOTION

Supported Series : Schneider MDrivePlus

Website: <http://motion.schneider-electric.com/index.html>

HMI Setting:

Parameters	Recommended	Options	Notes
PLC type	Schneider IMS MOTION		
PLC I/F	RS232		
Baud rate	9600		
Data bits	8		
Parity	Even		
Stop bits	1		
PLC sta. no.	0		

Device Address:

Bit/Word	Device type	Format	Range	Memo
W	A	D	0	
W	C1	D	0	
W	C	D	0	
W	D	D	0	
W	P	D	0	
W	R1	D	0	
W	R2	D	0	
W	R3	D	0	
W	R4	D	0	
W	VI	D	0	
W	VM	D	0	
W	EX	D	0	
W	S	D	0	
W	MR	D	0	
W	D1	D	0	
W	D2	D	0	
W	D3	D	0	
W	D4	D	0	
W	DE	D	0	

Bit/Word	Device type	Format	Range	Memo
W	DG	D	0	
W	HC	D	0	
W	HT	D	0	
W	MS	D	0	
W	MT	D	0	
W	PY	D	0	
W	QD	D	0	
W	RC	D	0	
W	WT	D	0	
W	BD	D	0	
W	Ram_K	D	0	
W	Ram_G	D	0	
W	Ram_Q	D	0	

Wiring Diagram:

Diagram 1

cMT Series

cMT3151

eMT Series

eMT3070 / eMT3105 / eMT3120 / eMT3150

MT-iE

MT8073iE / MT8102iE

MT-XE

MT8092XE

MT-iP

MT6103iP

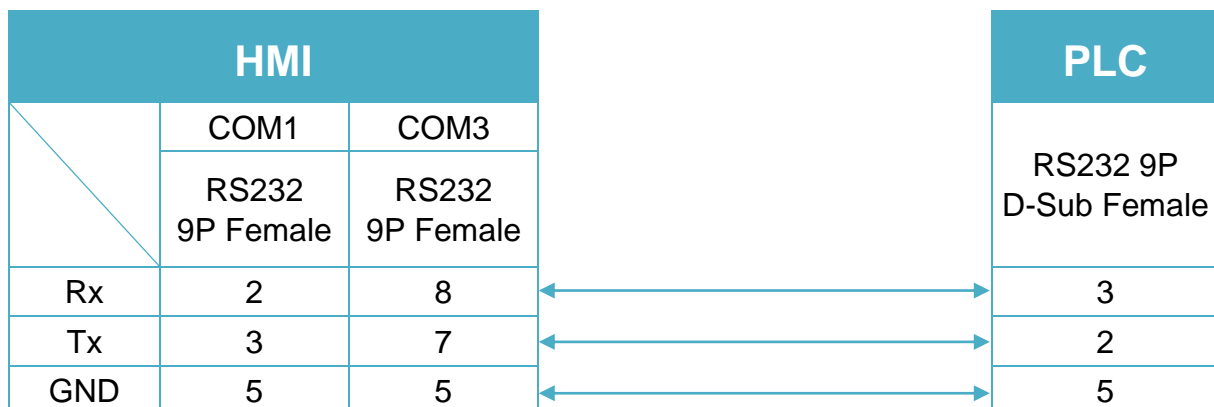


Diagram 2

cMT Series	cMT-SVR
mTV	mTV
MT-iE	MT8070iE / MT6070iE / MT8100iE / MT8121iE / MT8150iE / MT8071iE / MT6071iE / MT8072iE / MT6072iE / MT8073iE / MT8101iE / MT8102iE / MT8103iE
MT-XE	MT8121XE / MT8150XE / MT8090XE

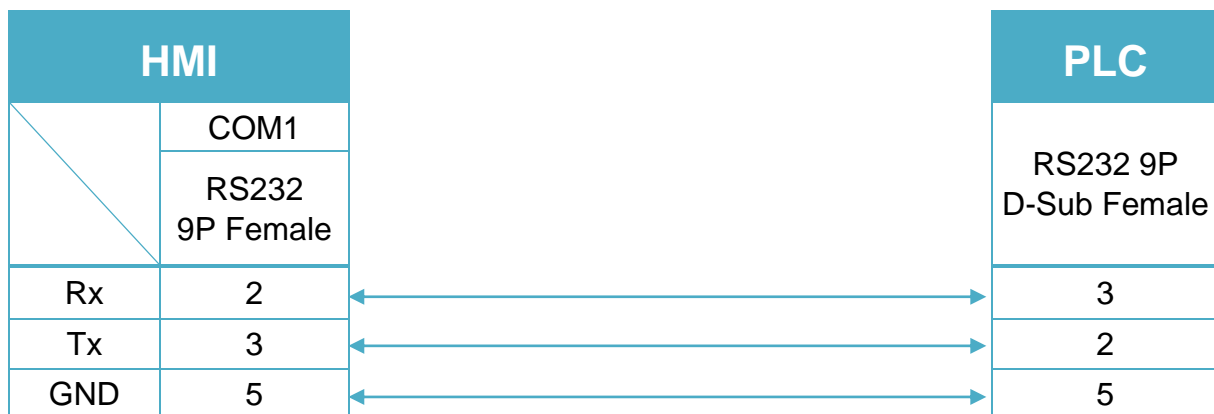
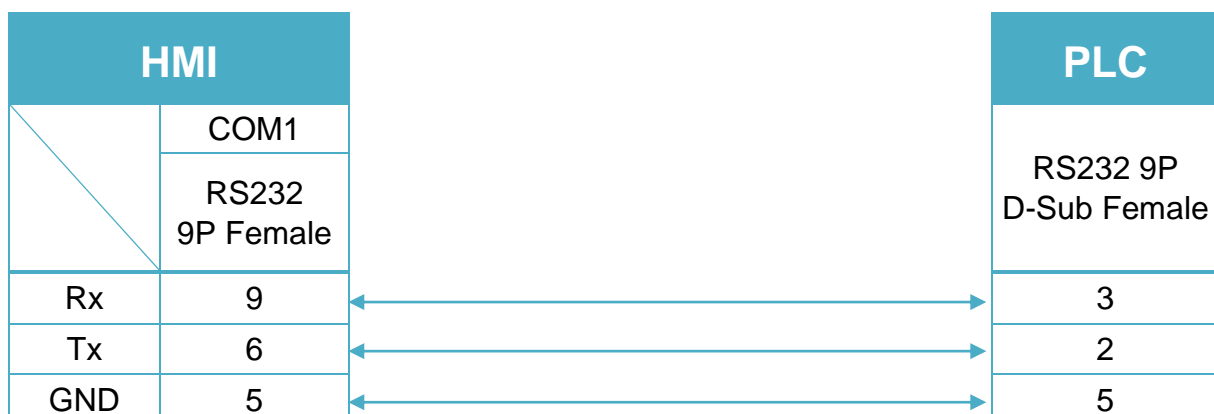


Diagram 3

MT-iE	MT8050iE
MT-iP	MT6051iP / MT6071iP / MT8071iP



Schneider IMS SERVO

Supported Series : Schneider Lexium MDrive

Website: <http://motion.schneider-electric.com/index.html>

HMI Setting:

Parameters	Recommended	Options	Notes
PLC type	Schneider IMS SERVO		
PLC I/F	RS232		
Baud rate	9600		
Data bits	8		
Parity	Even		
Stop bits	1		
PLC sta. no.	1		

Device Address:

Bit/Word	Device type	Format	Range	Memo
B	BIT	HHHHo	0 ~ FFFF7	
W	WORD	HHHH	0 ~ FFFF	
DW	DWORD	HHHH	0 ~ FFFF	
Byte	BYTE	HHHH	0 ~ FFFF	

Wiring Diagram:

Diagram 1

cMT Series	<i>cMT3151</i>
eMT Series	<i>eMT3070 / eMT3105 / eMT3120 / eMT3150</i>
MT-iE	<i>MT8073iE / MT8102iE</i>
MT-XE	<i>MT8092XE</i>
MT-iP	<i>MT6103iP</i>

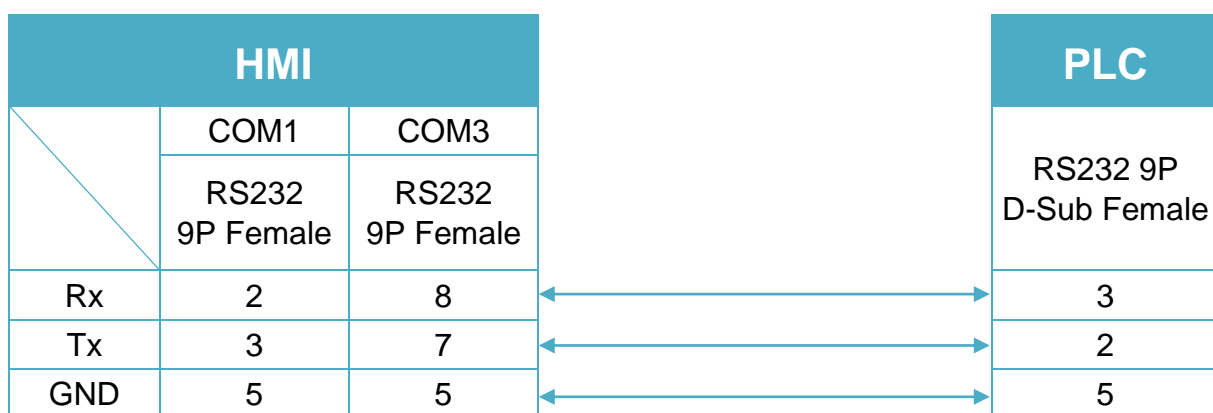


Diagram 2

cMT Series	<i>cMT-SVR</i>
mTV	<i>mTV</i>
MT-iE	<i>MT8070iE / MT6070iE / MT8100iE / MT8121iE / MT8150iE / MT8071iE / MT6071iE / MT8072iE / MT6072iE / MT8073iE / MT8101iE / MT8102iE / MT8103iE</i>
MT-XE	<i>MT8121XE / MT8150XE / MT8090XE</i>

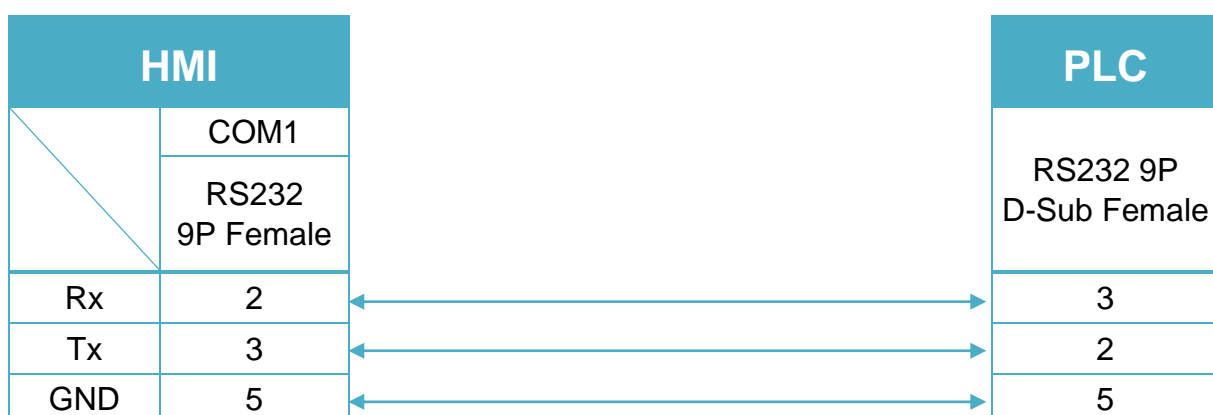
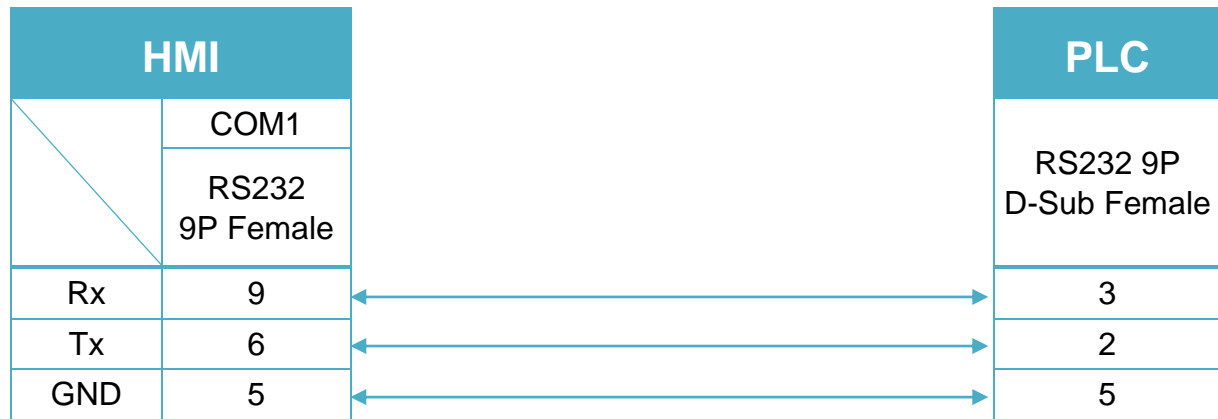


Diagram 3

MT-iE
MT8050iE
MT-iP
MT6051iP / MT6071iP / MT8071iP


Schneider MODBUS RTU

Supported Series : Schneider MODBUS RTU CONTROLLER (M221)

Website: <http://www.schneider-electric.com/site/home/index.cfm/ww/>

HMI Setting:

Parameters	Recommended	Options	Notes
PLC type	Schneider MODBUS RTU		
PLC I/F	RS485	RS232/RS485	
Baud rate	9600	9600~115200	
Data bits	8	7,8	
Parity	Even	Even, Odd, None	
Stop bits	1	1,2	
PLC sta. no.	1	0-255	

Online simulator	YES	Broadcast command	YES
Extend address mode	YES		

PLC Setting:

Communication mode	Modbus RTU protocol
--------------------	---------------------

Device Address:

Bit/Word	Device type	Format	Range	Memo
B	%IX	DDDDDo	0 ~ 655357	Input bit (read only)
B	%QX	DDDDDo	0 ~ 655357	Write multiple coils
B	%MX	DDDDDDDo	0 ~ 9999997	Output register bit (octal)
B	%M	DDDDD	0 ~ 65535	Output bit
B	%MW_Bit	DDDDDdd	0 ~ 6553515	Output register bit (decimal)
B	1x	DDDDD	0 ~ 65535	Input bit (read only)
B	0x_multi_coils	DDDDD	0 ~ 65535	Write multiple coils
B	3x_Bit	DDDDDdd	0 ~ 6553515	Input register bit (read only)
W	%MW	DDDDDD	0 ~ 999999	Output register
DW	%MD	DDDDDD	0 ~ 999999	Output register
W	3x	DDDDD	0 ~ 65535	Input Register (read only)
DW	5x	DDDDD	0 ~ 65535	4x double word swap

Bit/Word	Device type	Format	Range	Memo
DW	6x	DDDDD	0 ~ 65535	4x single word write

Wiring Diagram:

RJ45 Connector (Diagram 1 ~ Diagram 6)



Diagram 1

cMT Series *cMT3151*

eMT Series *eMT3070 / eMT3105 / eMT3120 / eMT3150*

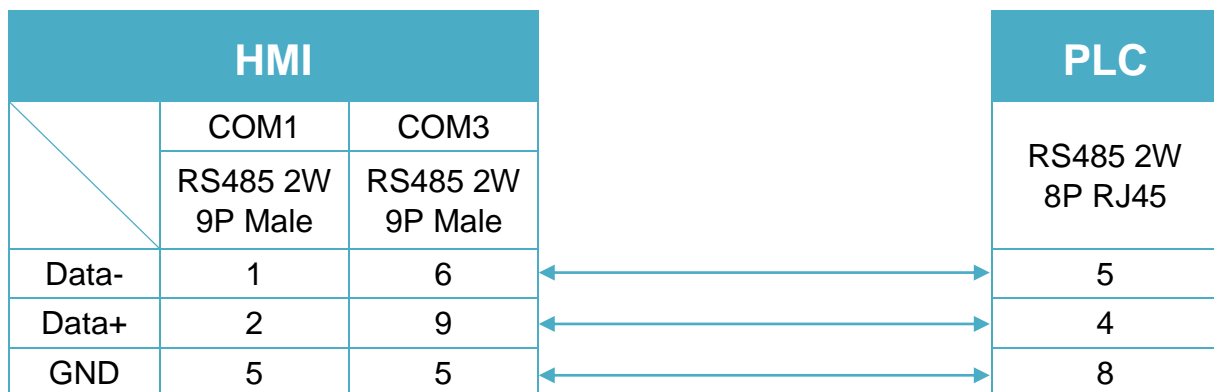


Diagram 2

cMT Series *cMT-SVR*

mTV *mTV*

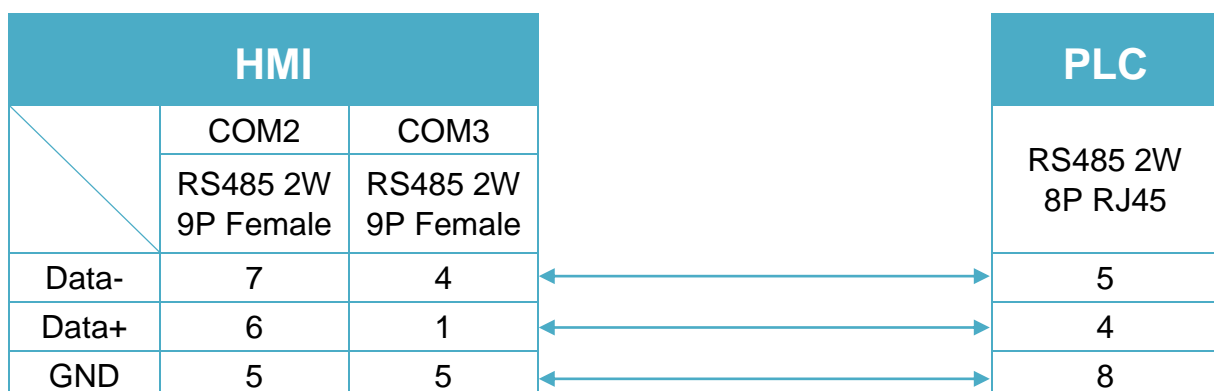


Diagram 3

MT-iE *MT8070iE / MT6070iE / MT8100iE / MT8121iE / MT8150iE*

MT-XE *MT8121XE / MT8150XE*

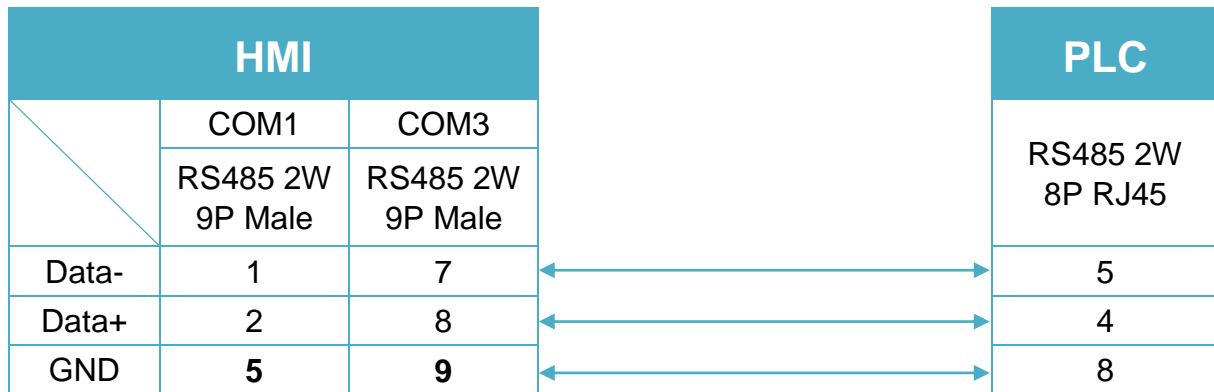


Diagram 4

MT-iE *MT8071iE / MT6071iE / MT8072iE / MT6072iE / MT8073iE /
MT8101iE / MT8102iE / MT8103iE*

MT-XE *MT8090XE / MT8092XE*

MT-iP *MT6103iP*

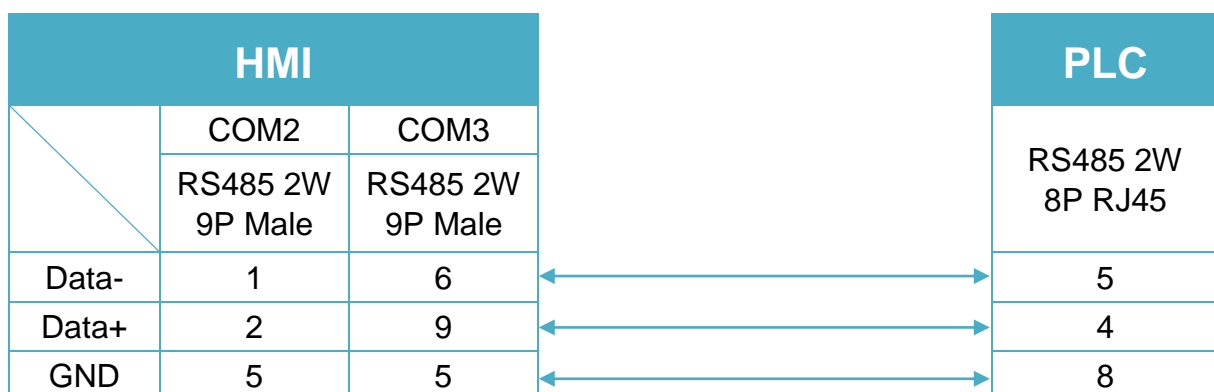
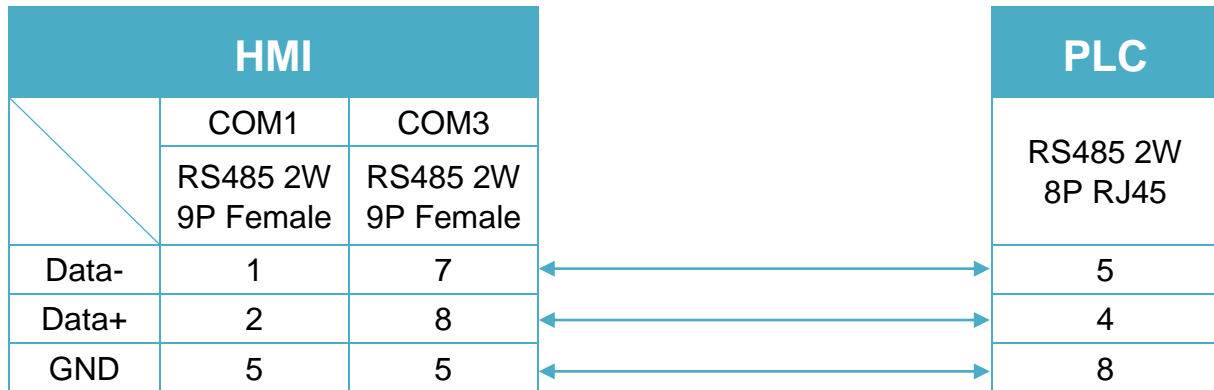
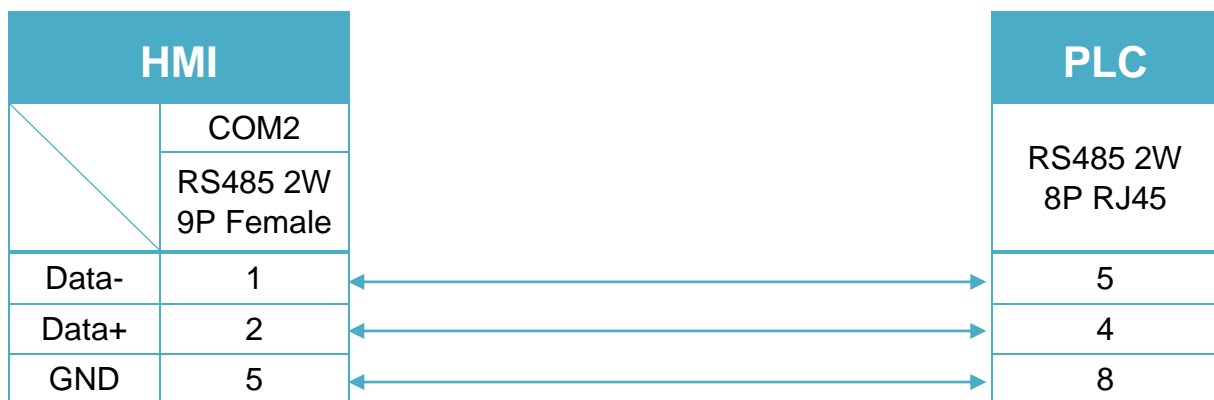


Diagram 5
MT-iE *MT8050iE*
MT-iP *MT6051iP*

Diagram 6
MT-iP *MT6071iP / MT8071iP*


Schneider MODBUS TCP/IP

Supported Series : Schneider Modbus RTU TCP/IP Device. (M221)

Website: <http://www.schneider-electric.com/site/home/index.cfm/ww/>

HMI Setting:

Parameters	Recommended	Options	Notes
PLC type	Schneider MODBUS TCP/IP		
PLC I/F	Ethernet		
Port no.	502		
PLC sta. no.	1	0~255	

PLC Setting:

Ethernet frame format	Ethernet II format
------------------------------	--------------------

Device Address:

Bit/Word	Device type	Format	Range	Memo
B	%IX	DDDDo	0 ~ 81927	Input bit (read only)
B	%QX	DDDDo	0 ~ 81927	Write multiple coils
B	%MX	DDDDDDo	0 ~ 1310707	Output register bit (octal)
B	%M	DDDDD	0 ~ 65535	Output bit
B	%MW_Bit	DDDDDdd	0 ~ 6553515	Output register bit (decimal)
B	1x	DDDDD	0 ~ 65535	Input bit (read only)
B	0x_multi_coils	DDDDD	0 ~ 65535	Write multiple coils
B	3x_Bit	DDDDDdd	0 ~ 6553515	Input register bit (read only)
W	%MW	DDDDD	0 ~ 65535	Output register
DW	%MD	DDDDD	0 ~ 32767	Output register
W	3x	DDDDD	0 ~ 65535	Input Register (read only)
DW	5x	DDDDD	0 ~ 65535	4x double word swap
DW	6x	DDDDD	0 ~ 65535	4x single word write

Wiring Diagram:

Etehernet cable:



Schneider PowerLogic Modbus RTU

Supported Series : Schneider PowerLogic Modbus RTU

Website : <https://www.schneider-electric.com/ww/en/>

HMI Setting:

Parameters	Recommended	Options	Notes
PLC type	Schneider PowerLogic Modbus RTU		
PLC I/F	RS485	RS232/RS485	
Baud rate	9600	9600~115200	
Data bits	8	7,8	
Parity	Even	Even, Odd, None	
Stop bits	1	1,2	
PLC sta. no.	1	0-255	

*Support communications between HMI and PLC in pass-through mode

*Set LW-9903 to 2 to enhance the speed of download/upload PLC program in pass-through mode

Online simulator	YES	Broadcast command	YES
Extend address mode	YES		

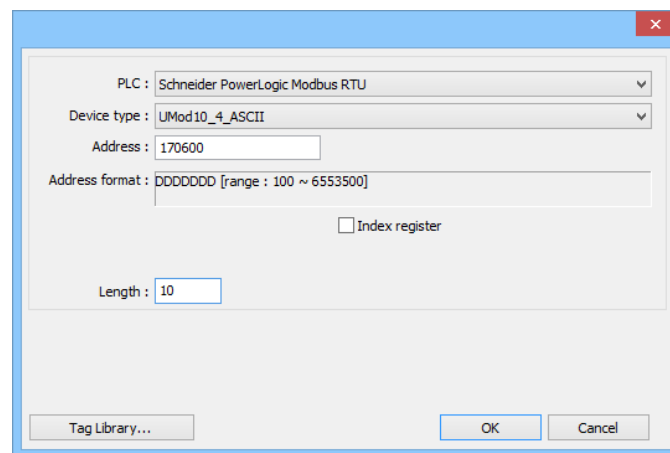
Device Address:

Bit/Word	Device type	Format	Range	Memo
B	0x	DDDDD	0 ~ 65535	Output bit
B	1x	DDDDD	0 ~ 65535	Input bit (read only)
B	3x_Bit	DDDDDdd	0 ~ 6553515	Input Register bit (read only)
B	4x_Bit	DDDDDdd	0 ~ 6553515	Output Register bit
B	0x_multi_coils	DDDDD	0 ~ 65535	Write multiple coils
W	3x	DDDDD	0 ~ 65535	Input Register (read only)
W	4x	DDDDD	0 ~ 65535	Output Register
DW	5x	DDDDD	0 ~ 65535	4x double word swap
W	6x	DDDDD	0 ~ 65535	4x single word write
W	UMod10_4_ASCII	DDDDDDD	100 ~ 6553500	Read 64 bits unsigned data
W	UMod10_3_ASCII	DDDDDDD	100 ~ 6553500	Read 48 bits unsigned data
W	Mod10_2	DDDDD	1 ~ 65535	Read 32 bits data
W	UINT64_ASCII	DDDDDDD	100 ~ 6553500	Read 64 bits unsigned data

Bit/Word	Device type	Format	Range	Memo
W	Mod10_4_ASCII	DDDDDDDD	100 ~ 6553500	Read 64 bits signed data
W	Mod10_3_ASCII	DDDDDDDD	100 ~ 6553500	Read 48 bits signed data
W	INT64_ASCII	DDDDDDDD	100 ~ 6553500	Read 64 bits signed data

Use the driver “Schneider PowerLogic Modbus RTU”, you should see that it has extra data types in addition to Modbus ones. Because the 64-bit objects are not natively supported by numeric objects yet, we have to use ASCII objects to display them.

You can treat Mod10_2 just as any other normal address because it’s also 32 bit data. However, when you use ASCII types, please beware of its special addressing method, and the length of memory allocation.



Addressing method:

it is necessary to add a suffix of 00. For example, to read register 1716 [Energy, Real Total] in PM800, you should address it with 171600.

Length of memory allocation:

When using ASCII, it is necessary to specify the length, that is, the number of word memory. Each WORD holds two characters. So if , as the picture above, I’ve specified the length of 10, I can have maximum of 20 characters for this object (including the negative sign). Please adjust this parameter according to the expected data.

Wiring Diagram:

RS232 terminal (Diagram 1 ~ Diagram 3)

Diagram 1

cMT Series	<i>cMT3151</i>
eMT Series	<i>eMT3070 / eMT3105 / eMT3120 / eMT3150</i>
MT-iE	<i>MT8073iE / MT8102iE</i>
MT-XE	<i>MT8092XE</i>
MT-iP	<i>MT6103iP</i>

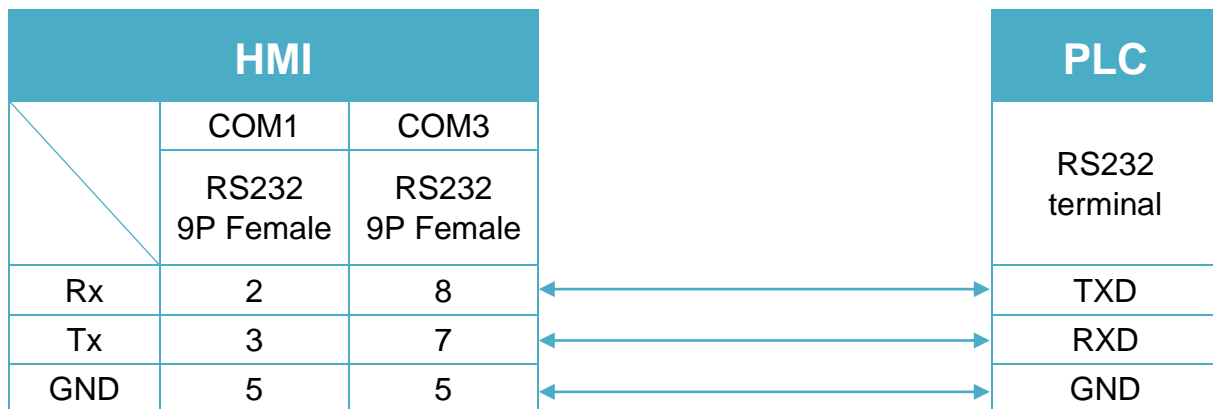


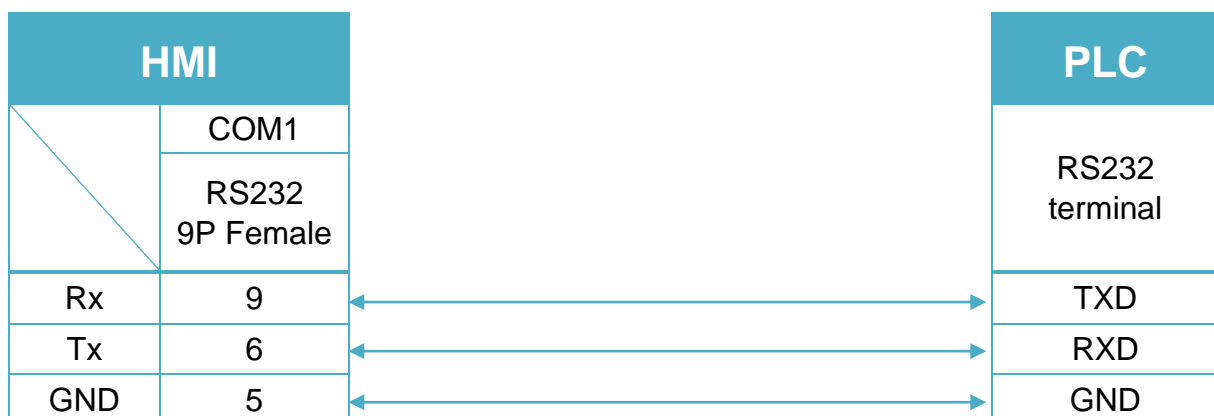
Diagram 2

cMT Series	cMT-SVR
mTV	mTV
MT-iE	MT8070iE / MT6070iE / MT8100iE / MT8121iE / MT8150iE / MT8071iE / MT6071iE / MT8072iE / MT6072iE / MT8073iE / MT8101iE / MT8102iE / MT8103iE
MT-XE	MT8121XE / MT8150XE / MT8090XE



Diagram 3

MT-iE	MT8050iE
MT-iP	MT6051iP / MT6071iP / MT8071iP



RS485 4W terminal (Diagram 4 ~ Diagram 7)

Diagram 4

cMT Series	<i>cMT3151</i>
eMT Series	<i>eMT3070 / eMT3105 / eMT3120 / eMT3150</i>
MT-iE	<i>MT8070iE / MT6070iE / MT8100iE / MT8121iE / MT8150iE</i>
MT-XE	<i>MT8121XE / MT8150XE</i>

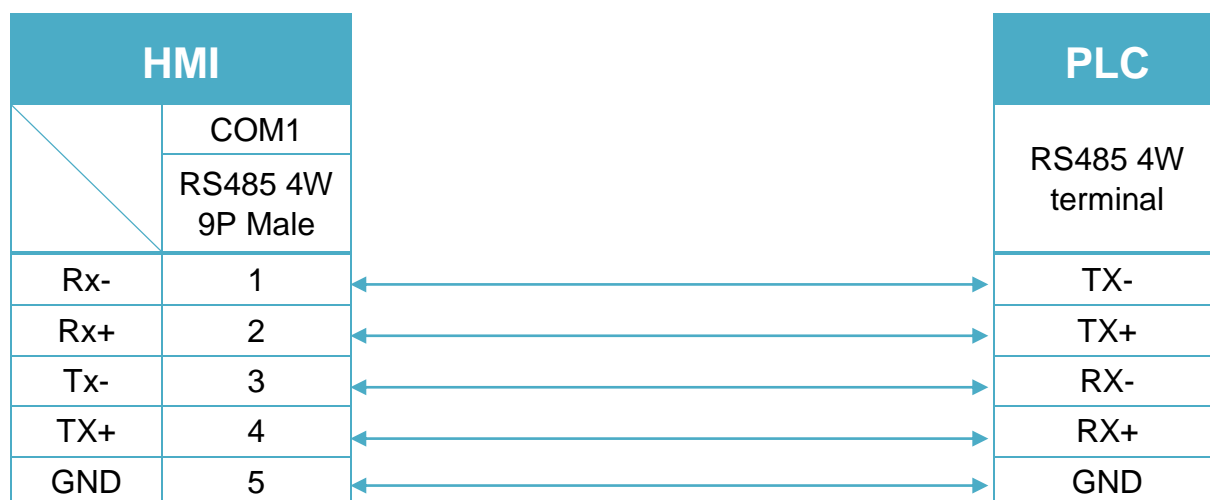


Diagram 5

cMT Series	<i>cMT-SVR</i>
mTV	<i>mTV</i>

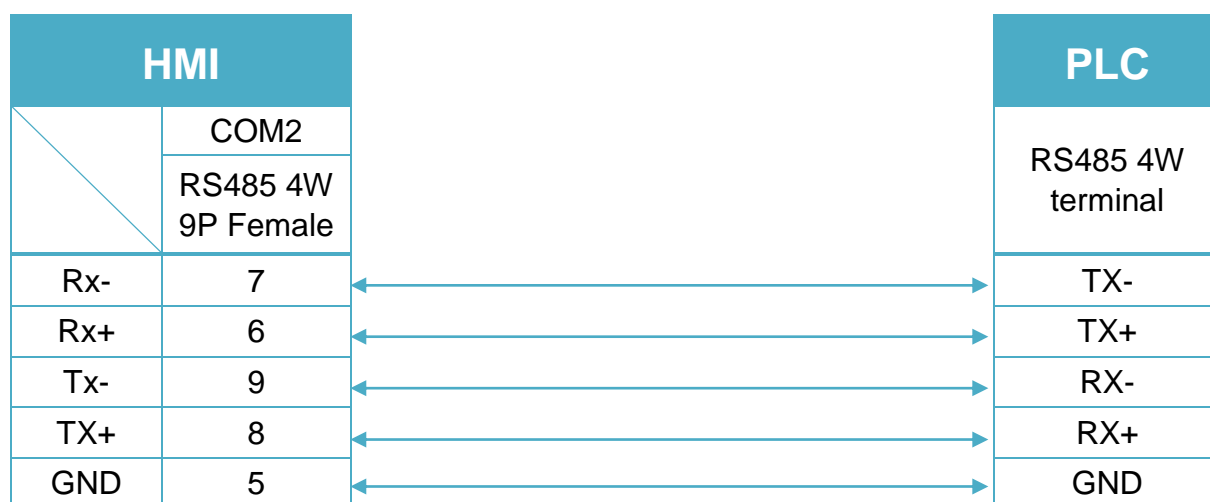


Diagram 6

MT-iE	<i>MT8071iE / MT6071iE / MT8072iE / MT6072iE / MT8073iE / MT8101iE / MT8102iE / MT8103iE</i>
MT-XE	<i>MT8090XE / MT8092XE</i>
MT-iP	<i>MT6071iP / MT8071iP / MT6103iP</i>

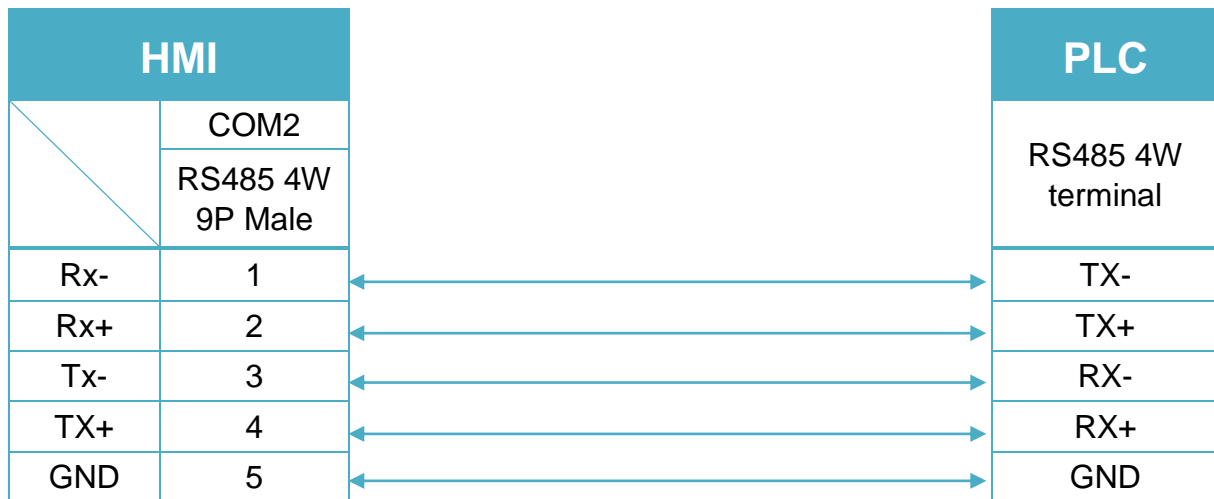
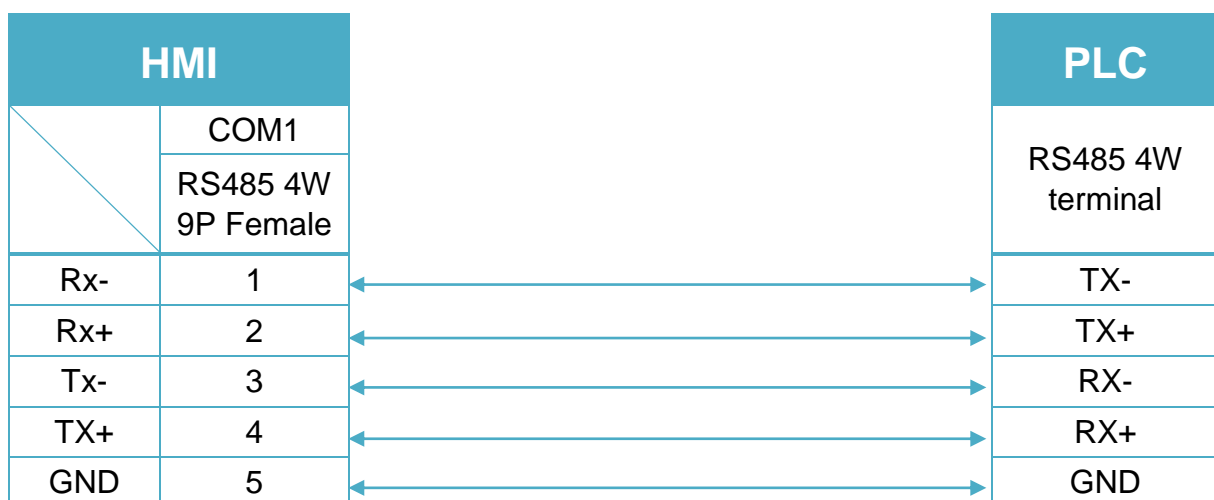


Diagram 7

MT-iE	<i>MT8050iE</i>
MT-iP	<i>MT6051iP</i>



RS485 2W terminal (Diagram 8 ~ Diagram 13)

Diagram 8

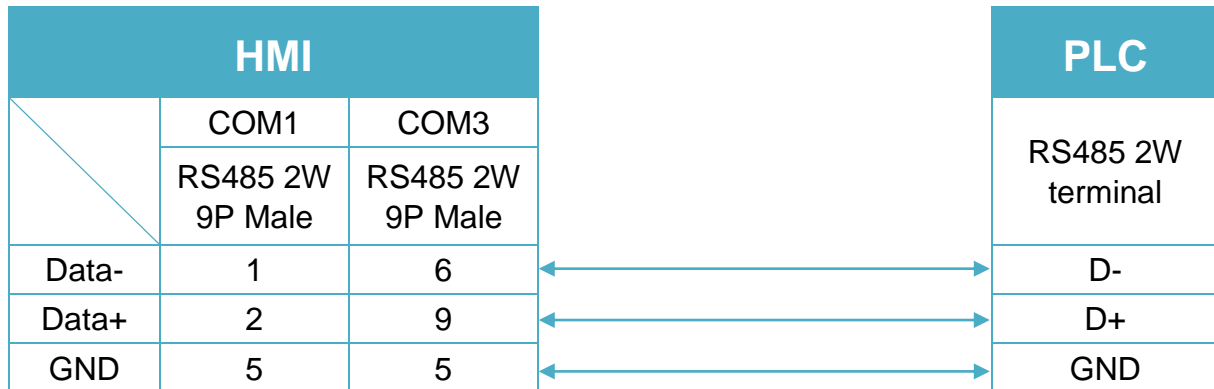
cMT Series
cMT3151
eMT Series
eMT3070/ eMT3105 / eMT3120 / eMT3150


Diagram 9

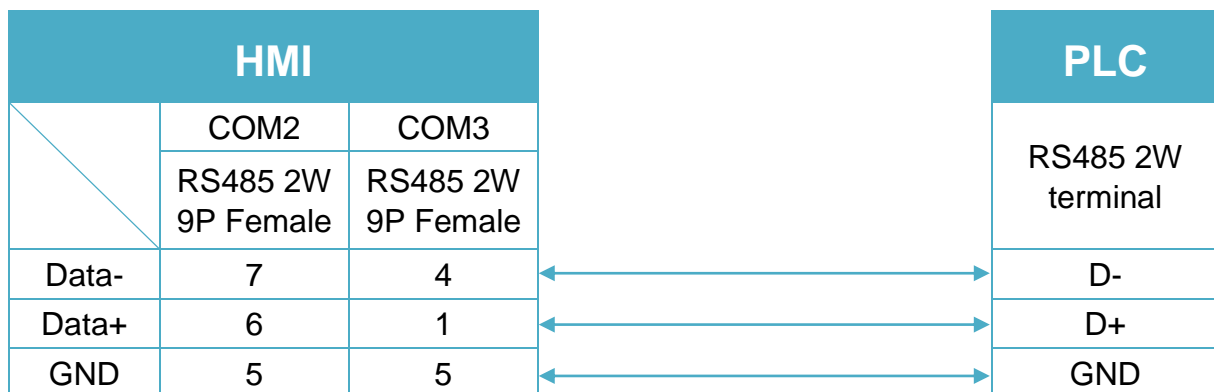
cMT Series
cMT-SVR
mTV
mTV


Diagram 10

MT-iE *MT8070iE / MT6070iE / MT8100iE / MT8121iE / MT8150iE*

MT-XE *MT8121XE / MT8150XE*

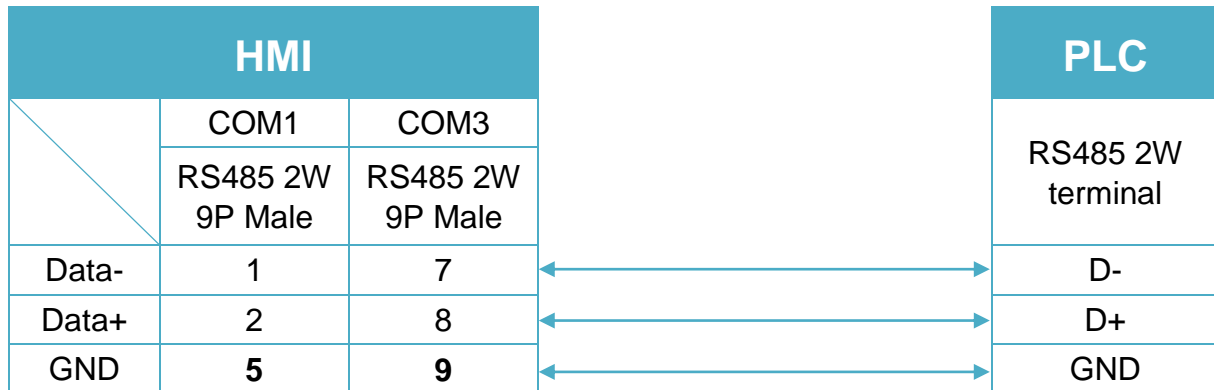


Diagram 11

MT-iE *MT8071iE / MT6071iE / MT8072iE / MT6072iE / MT8073iE / MT8101iE / MT8102iE / MT8103iE*

MT-XE *MT8090XE / MT8092XE*

MT-iP *MT6103iP*

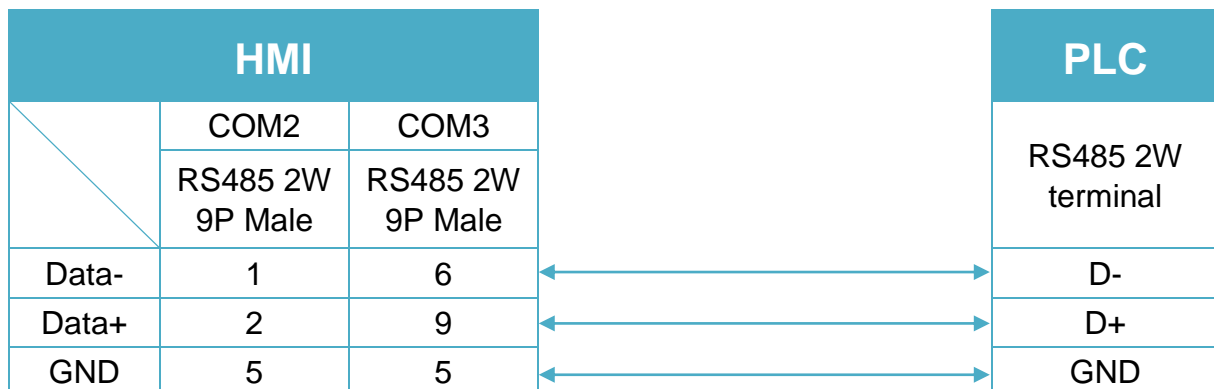


Diagram 12

MT-iE *MT8050iE*

MT-iP *MT6051iP*

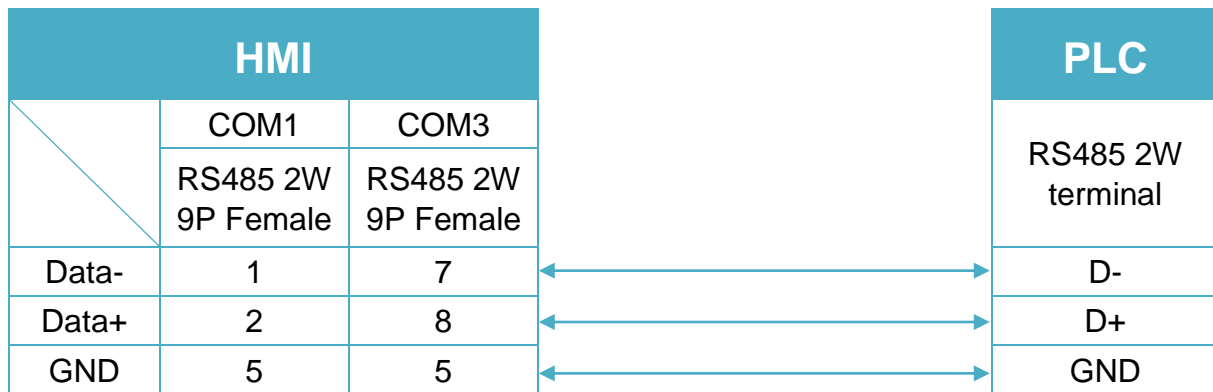
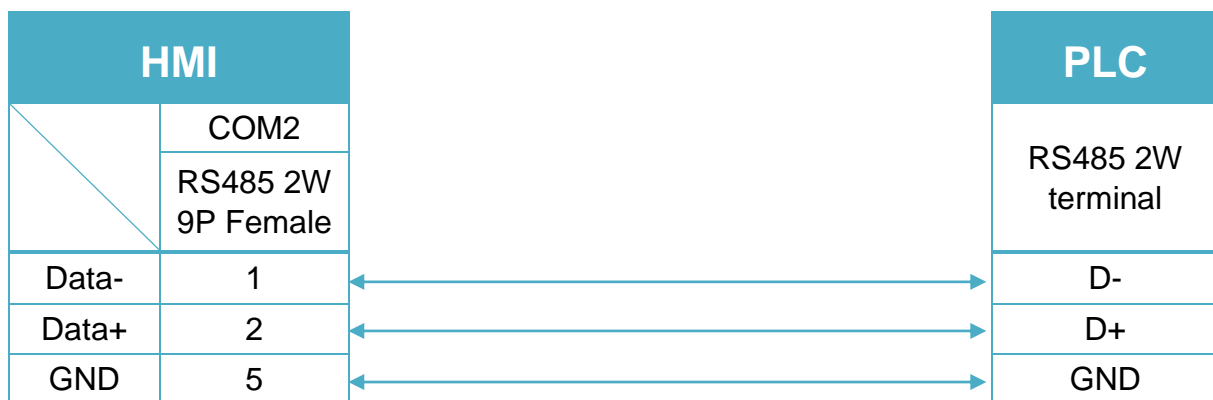


Diagram 13

MT-iP *MT6071iP / MT8071iP*



Schneider SoMachine M Series (Ethernet)

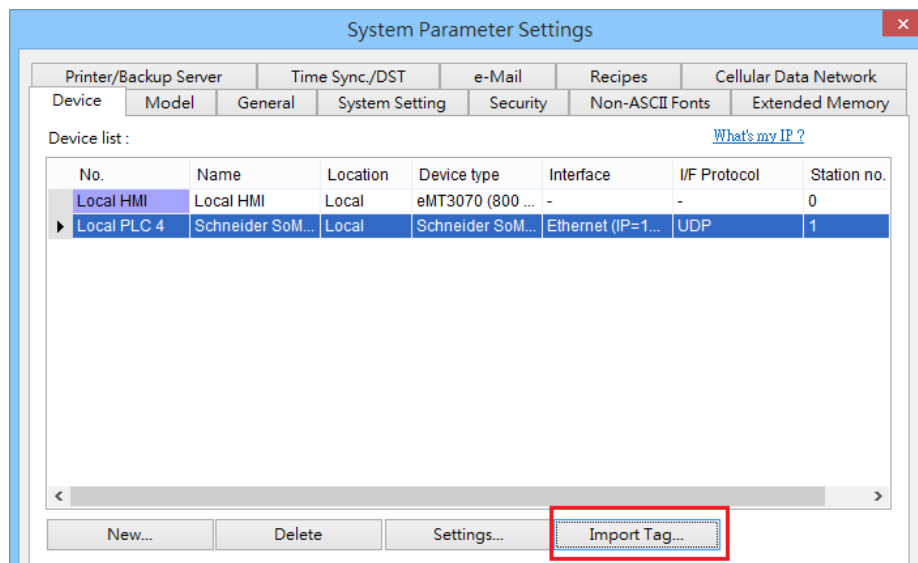
Supported series: Schneider SoMachine M238/M241/M251/M258

HMI Setting:

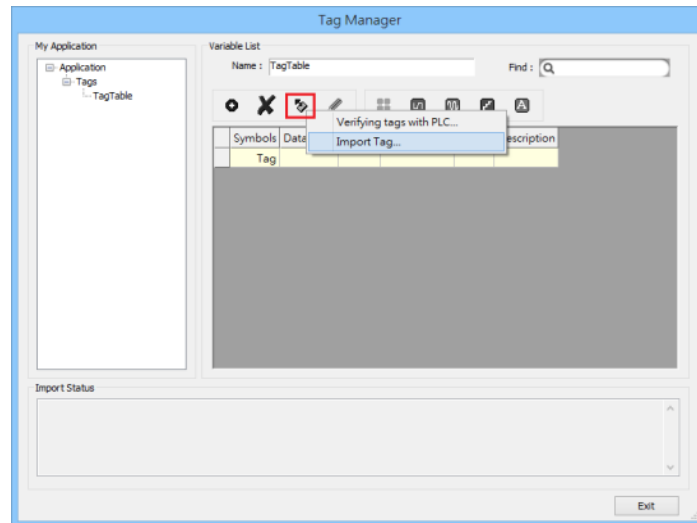
Parameters	Recommended	Options	Notes
PLC type	Schneider SoMachine M Series		
PLC I/F	Ethernet		Use UDP
Port no.	1740		
Source port no.	1742	1740/1742	M258: 1740 Other: 1742

How to Import Tags:

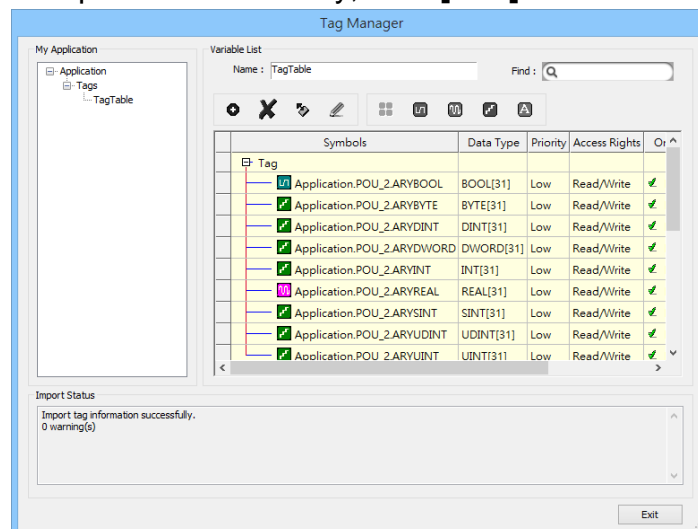
- In System Parameter Settings click **[New]** to add Schneider SoMachine M Series driver into the device list and then click **[Import Tag]**.



9. In Tag Manager click **Get tag** -> **Import Tag**, and then select the tag file (.xml) generated by the PLC software.

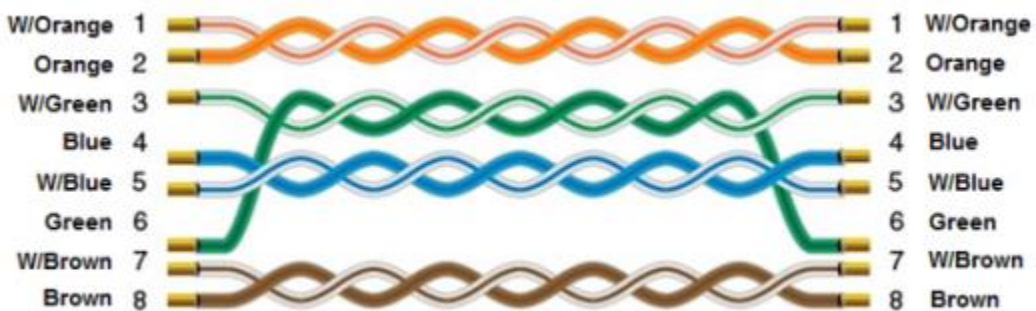


10. When the tags are imported successfully, click **[Exit]** to leave.



Wiring Diagram:

Etehernet cable:



Schneider UniTelway

Supported Series: Modicon TSX Micro&Nano&Neza series PLC.

Website: <http://www.modicon.com>

HMI Setting:

Parameters	Recommended	Options	Notes
PLC type	Schneider UniTelway		
PLC I/F	RS485 2W	RS232/RS485	
Baud rate	19200	9600~115200	
Data bits	8	7,8	Must set to 8 for this protocol
Parity	Odd	Even, Odd, None	
Stop bits	1	1, 2	
HMI sta. no.	5	1-8	
PLC sta. no.	0	0-3	

Online simulator	YES	Extend address mode	YES
Broadcast command	NO		

PLC Setting:

Communication mode	UniTelWay protocol, set PLC as master
---------------------------	---------------------------------------

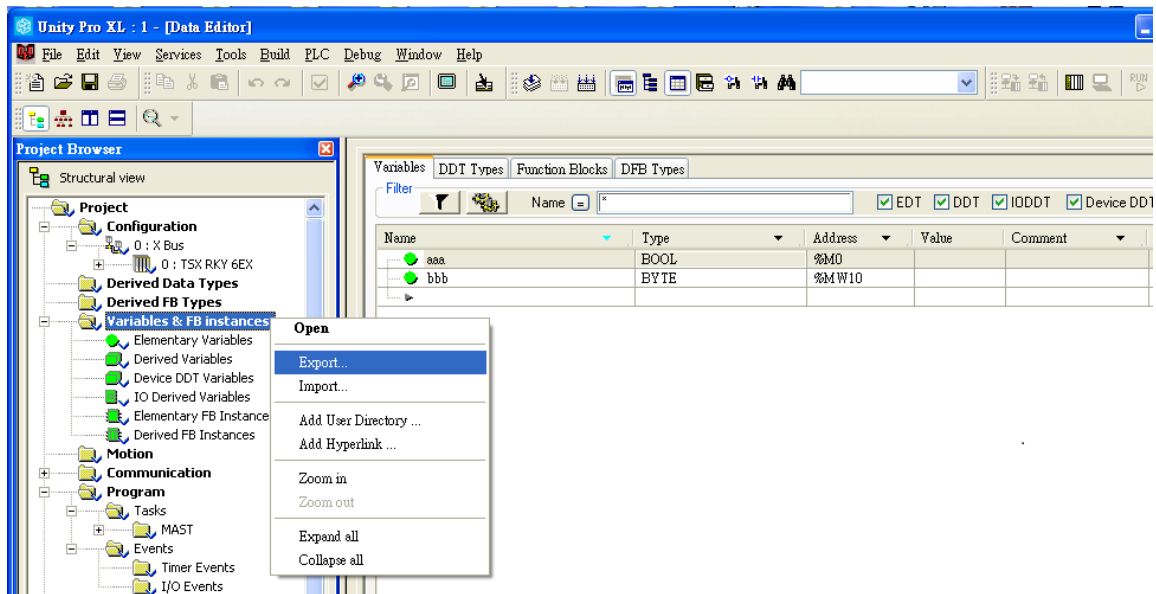
Device Address:

Bit/Word	Device type	Format	Range	Memo
B	S	DDDDD	0 ~ 32767	Internal relay
B	M	DDDDD	0 ~ 32767	Auxiliary relay
B	MW.B	DDDDDdd	0 ~ 3276715	Data register bit
W	MW	DDDDD	0 ~ 32767	Data register

How to Import Tags:

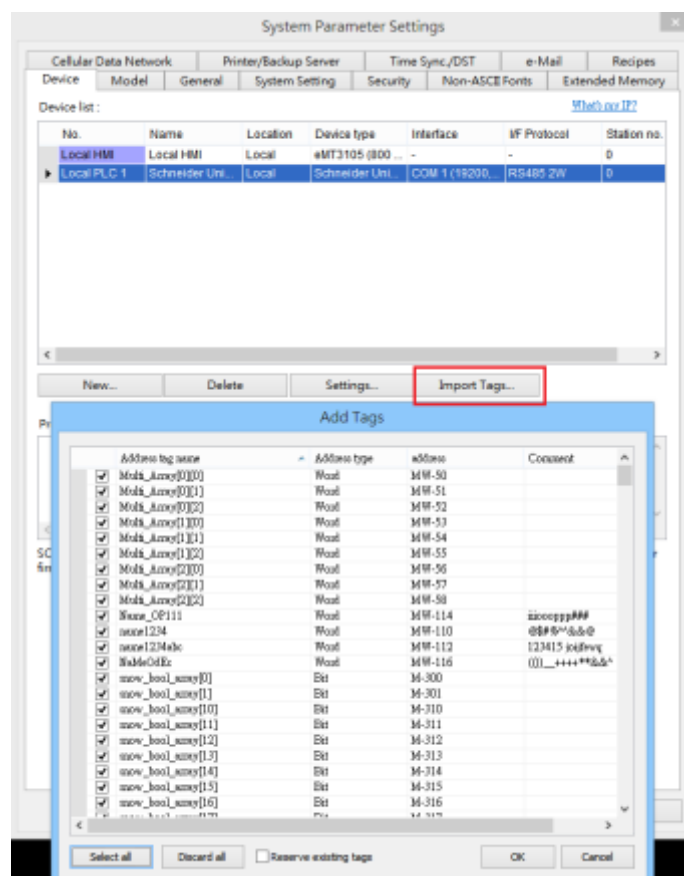
Export tag:

Unity Pro XL -> Variables & FB instances -> Export (*.XSY)



Import tag:

EasyBuilder Pro -> System Parameter Settings -> Import Tags



Wiring Diagram:

The following is the view from the soldering point of a cable.



TSX37-XX/TSX07-XX CPU : 9P D-Sub to 9P D-Sub

Diagram 1

cMT Series *cMT3151*

eMT Series *eMT3070 / eMT3105 / eMT3120 / eMT3150*

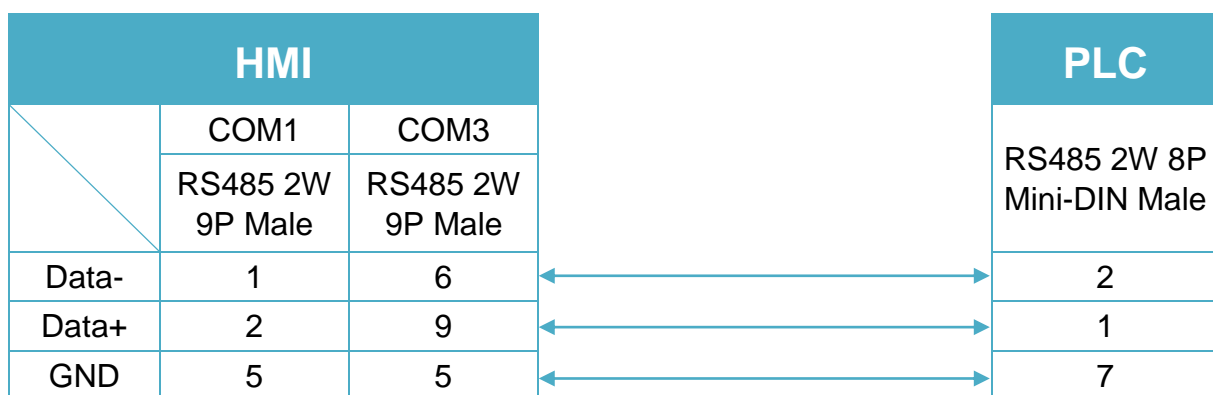


Diagram 2

cMT Series *cMT-SVR*

mTV *mTV*

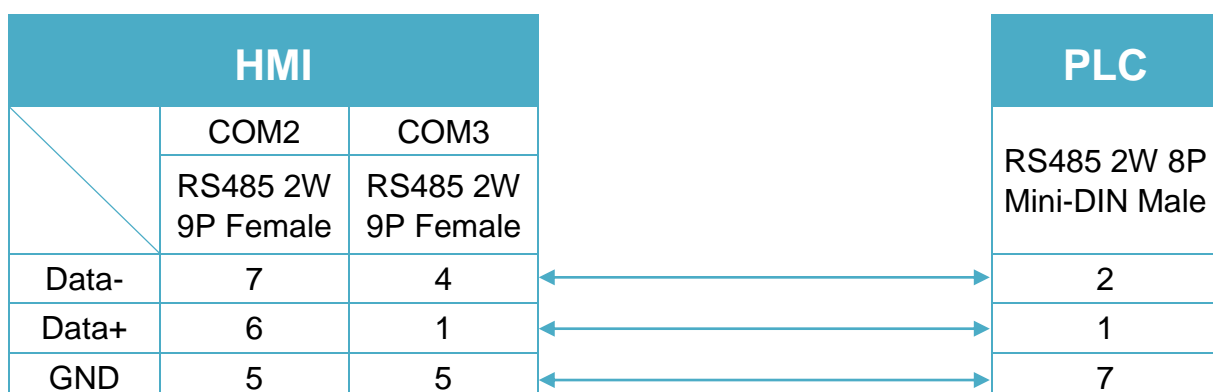


Diagram 3

MT-iE *MT8070iE / MT6070iE / MT8100iE / MT8121iE / MT8150iE*

MT-XE *MT8121XE / MT8150XE*

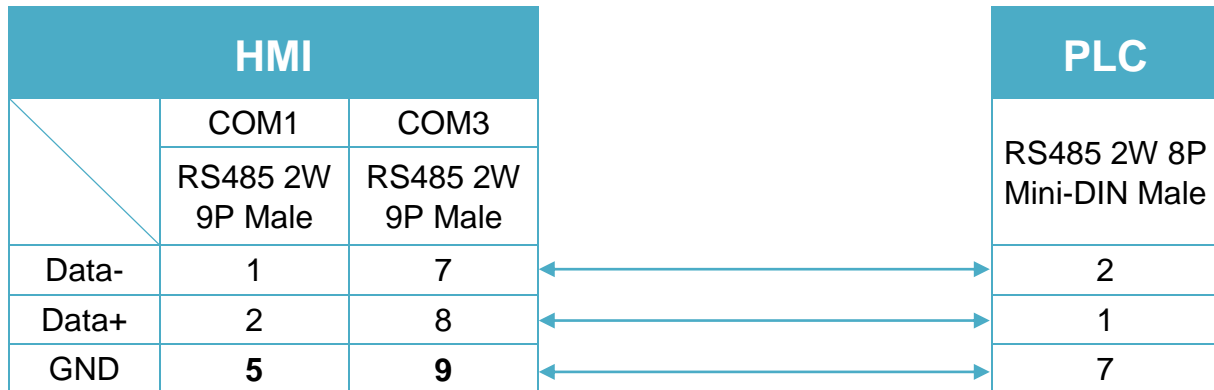


Diagram 4

MT-iE *MT8071iE / MT6071iE / MT8072iE / MT6072iE / MT8073iE / MT8101iE / MT8102iE / MT8103iE*

MT-XE *MT8090XE / MT8092XE*

MT-iP *MT6103iP*

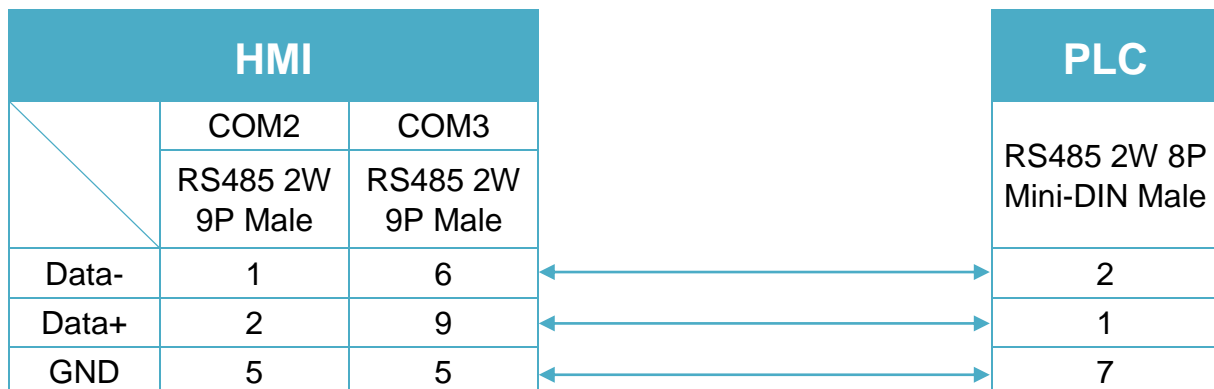


Diagram 5

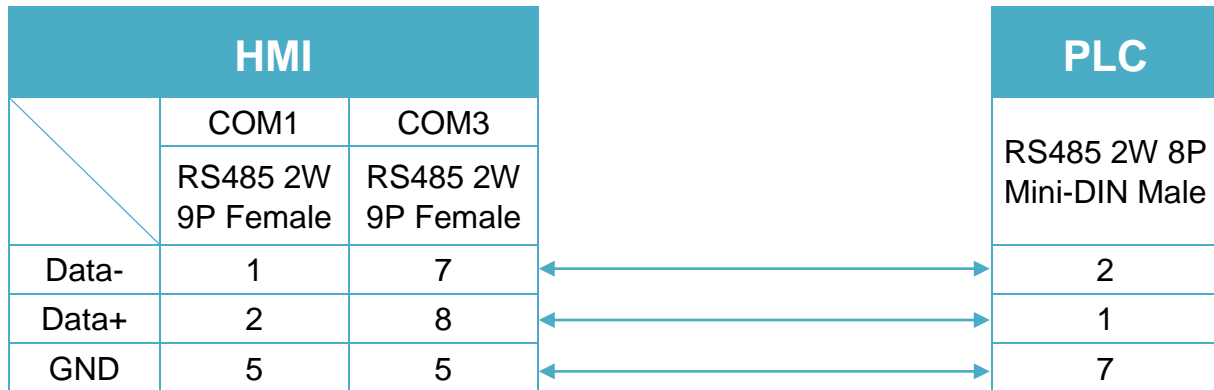
MT-iE *MT8050iE*
MT-iP *MT6051iP*


Diagram 6

MT-iP *MT6071iP / MT8071iP*


Schneider Zelio

Supported Series: Schneider Zelio Logic

Website: <http://www.schneider-electric.com/ww/en/>

HMI Setting:

Parameters	Recommended	Options	Notes
PLC type	Schneider Zelio		
PLC I/F	RS232		
Baud rate	115200		
Data bits	7		
Parity	Even		
Stop bits	1		
PLC sta. no.	1		

Device Address:

Bit/Word	Device type	Format	Range	Memo
B	I	DD	1 ~ 99	Input
B	SLI_Bit	DDh	10 ~ 24f	Serial link input
B	SLO_Bit	DDh	250 ~ 48f	Serial link output (read only)
B	State	D	1	State in PLC (read only)
W	AI	DD	1 ~ 99	Analogy input (default: 1 ~ 4)
W	SL_IN	DD	1 ~ 24	Serial link input
W	SL_OUT	DD	25 ~ 48	Serial link output (read only)
W	Time	D	1 ~ 6	Time & Day*
W	Order	D	1	Command** (write only)

* address 1 : second, address 2 : minute, address 3 : hour , address 4 : day, address 5 : month, address 6 : year. The value range for “Year” is 0~99, entering “0” represents year 2000, entering “99” represents year 2099.

** run mode write 2, stop mode write 1.

Wiring Diagram:

RS-232 9P D-Sub (Diagram 1 ~ Diagram 4)

Diagram 1

cMT Series	<i>cMT3151</i>
eMT Series	<i>eMT3070 / eMT3105 / eMT3120 / eMT3150</i>
MT-iE	<i>MT8070iE / MT6070iE / MT8100iE / MT8121iE / MT8150iE / MT8071iE / MT6071iE / MT8072iE / MT6072iE / MT8073iE / MT8101iE / MT8102iE / MT8103iE</i>
MT-XE	<i>MT8121XE / MT8150XE / MT8090XE / MT8092XE</i>
MT-iP	<i>MT6103iP</i>

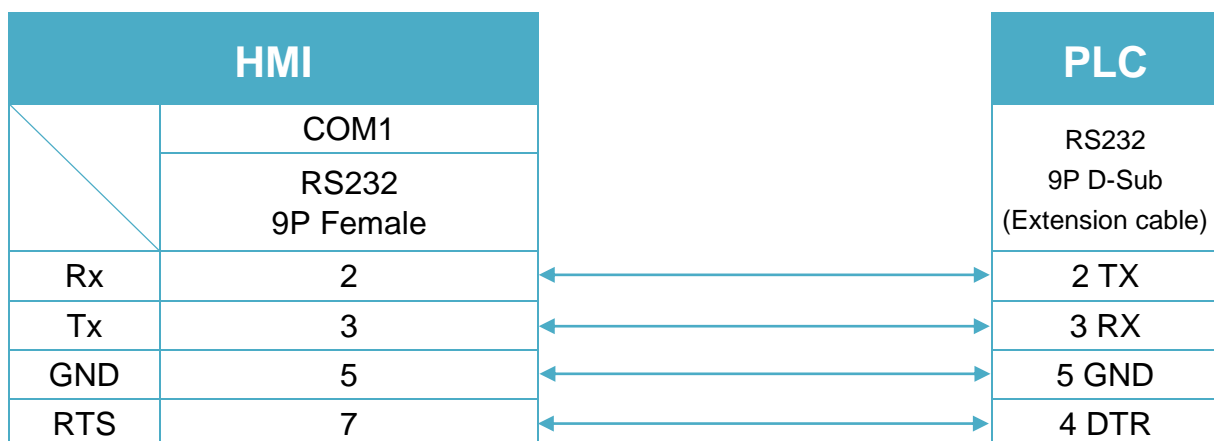


Diagram 2

cMT Series **cMT-SVR**

mTV **mTV**

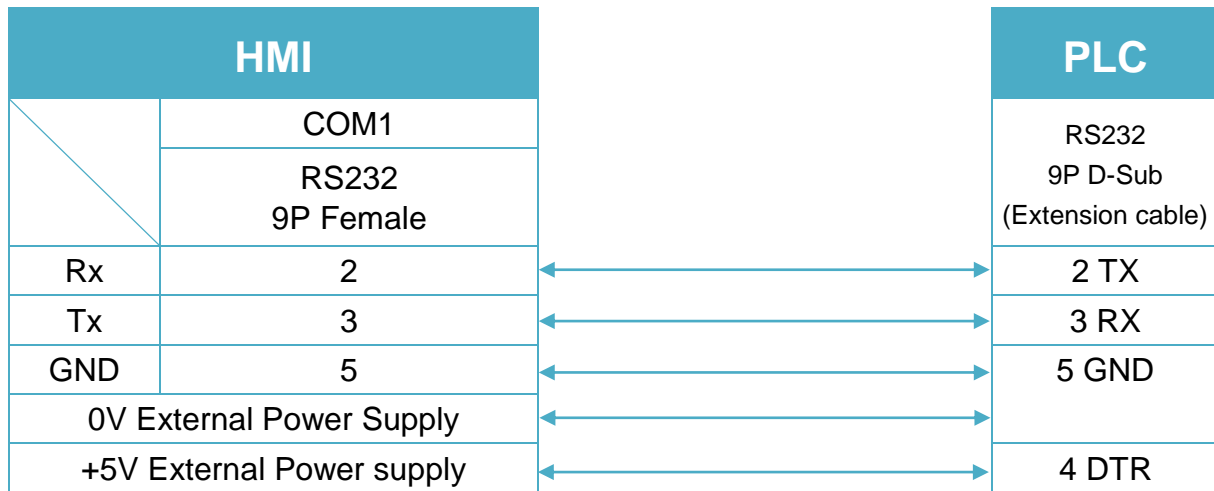


Diagram 3

MT-iE **MT8050iE**

MT-iP **MT6051iP**

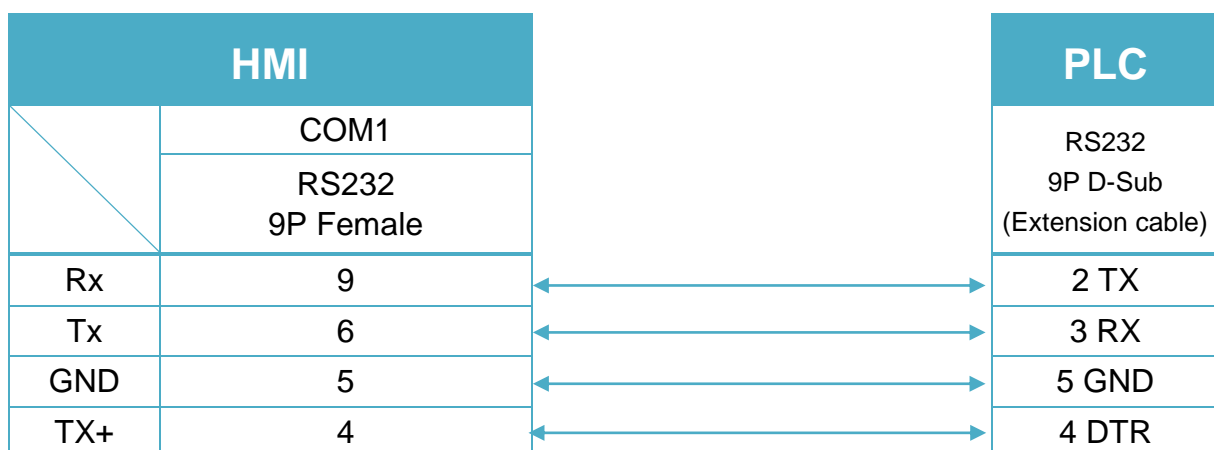
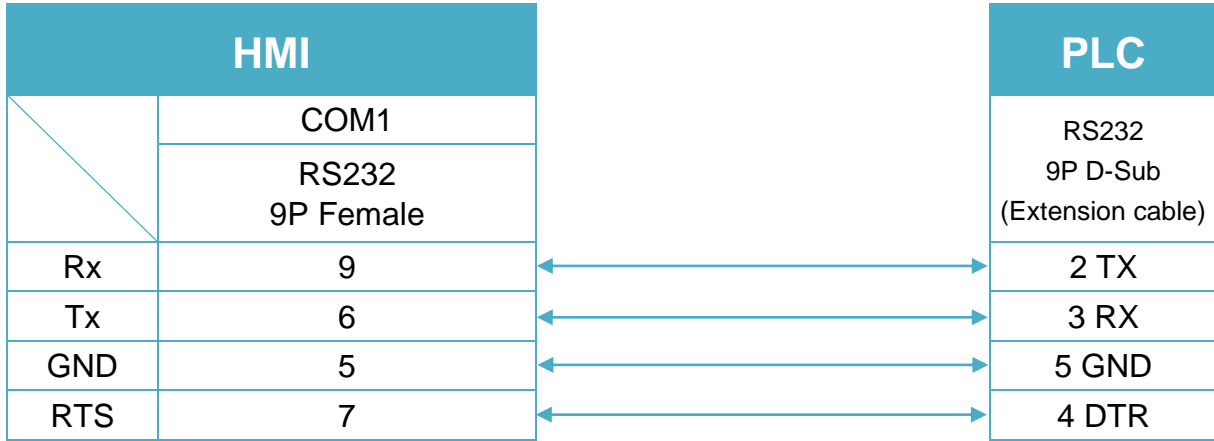


Diagram 4

MT-iP MT6071iP / MT8071iP



SR2CBL01 cable to 9-way serial port

Note: Please use SR2CBL01 cable (Accessories from Zelio Logic) and extension cable (as shown) to communicate with HMI series.



SERVO BLDC (400/750WD)

Supported Series: BLDC(400/750WD)

Website: <http://www.servoind.net/>

HMI Setting:

Parameters	Recommended	Options	Notes
PLC type	SERVO BLDC (400/750WD)		
PLC I/F	RS232		
Baud rate	19200		
Data bits	8		
Parity	None		
Stop bits	1		
PLC sta. no.	0		

Device Address:

Bit/Word	Device type	Format	Range	Memo
B	SET_SERVO	D	0	
B	SET_DIRECTION	D	0	
B	SET_BERAK	D	0	
B	RESET	D	0	
B	DRIVER_FAULT	D	0	
B	SERVO_OFF_ERROR	D	0	
B	BREAK_ON_ERROR	D	0	
W	SET_RPM	D	0	
W	RPM	D	0	
W	CUR_RPM	D	0	
W	CUR_ERROR	D	0	
W	PARAMETER1_W	D	0 ~ 7	
W	PARAMETER1_R	D	0 ~ 7	

Wiring Diagram:

Diagram 1

cMT Series	<i>cMT3151</i>
eMT Series	<i>eMT3070 / eMT3105 / eMT3120 / eMT3150</i>
MT-iE	<i>MT8073iE / MT8102iE</i>
MT-XE	<i>MT8092XE</i>
MT-iP	<i>MT6103iP</i>

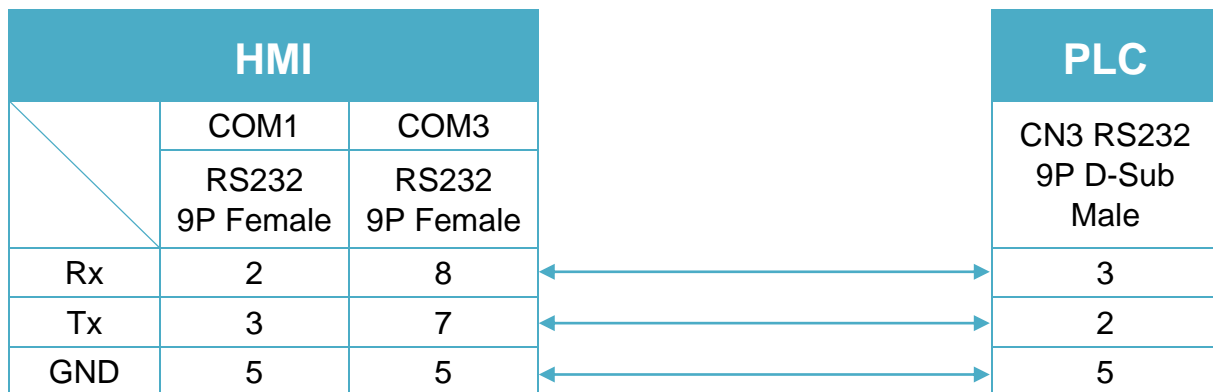


Diagram 2

cMT Series	cMT-SVR
mTV	mTV
MT-iE	MT8070iE / MT6070iE / MT8100iE / MT8121iE / MT8150iE / MT8071iE / MT6071iE / MT8072iE / MT6072iE / MT8073iE / MT8101iE / MT8102iE / MT8103iE
MT-XE	MT8121XE / MT8150XE / MT8090XE

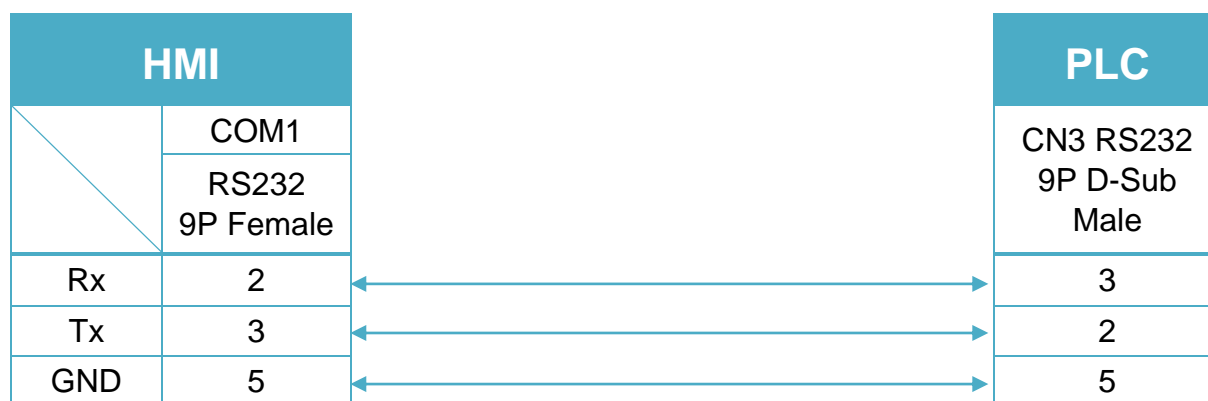
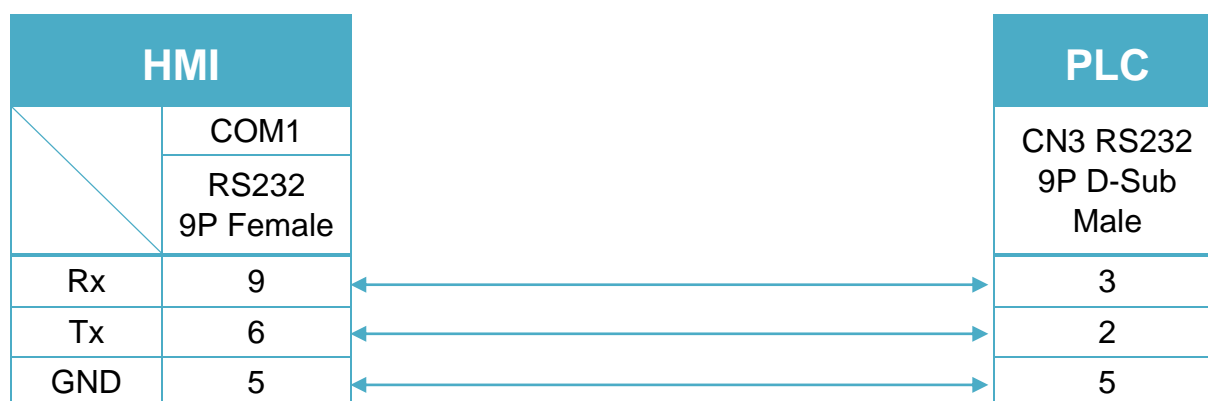


Diagram 3

MT-iE	MT8050iE
MT-iP	MT6051iP / MT6071iP / MT8071iP



SEUNGIL AHU

Supported Series: SENUGIL AVDP-NH-K1

Website : <http://seungil.en.ec21.com/>

HMI Setting:

Parameters	Recommended	Options	Notes
PLC type	SEUNGIL AHU		
PLC I/F	RS-485 2W	RS232, RS485 2W/4W	
Baud rate	9600	9600 ~ 115200	
Data bits	8	7,8	
Parity	None	Even, Odd, None	
Stop bits	1	1	
PLC sta. no.	1	0 ~ 99	
Turn around delay(ms)	0 (Normal) 30 (cMT Series)		

Online simulator	YES	Extend address	NO
------------------	-----	----------------	----

Device Address:

Bit/Word	Device type	Format	Range	Memo
B	BIT	DDD.DDD.DDDdd	0 ~ 255.255.25515	
W	WORD	DDD.DDD.DDD	0 ~ 255.255.255	

Wiring Diagram:

Diagram 1

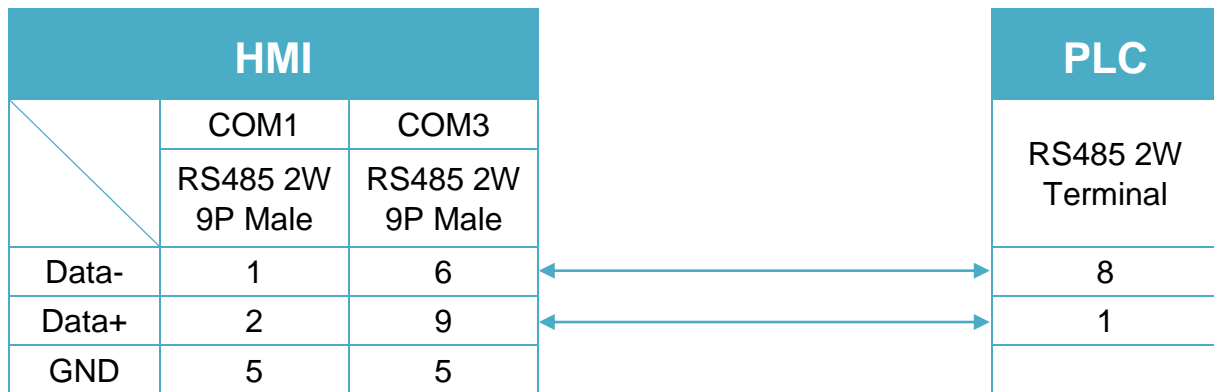
cMT Series
cMT3151
eMT Series
eMT3070 / eMT3105 / eMT3120 / eMT3150


Diagram 2

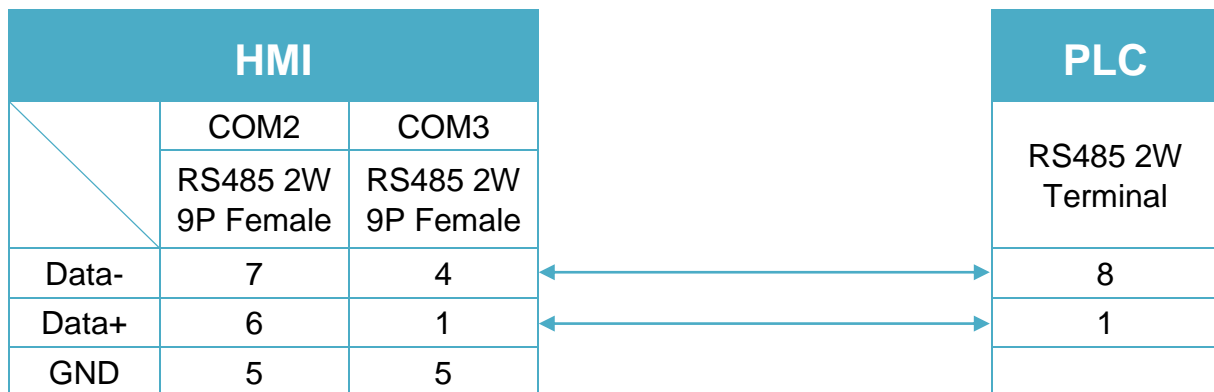
cMT Series
cMT-SVR
mTV
mTV


Diagram 3

MT-iE *MT8070iE / MT6070iE / MT8100iE / MT8121iE / MT8150iE*

MT-XE *MT8121XE / MT8150XE*

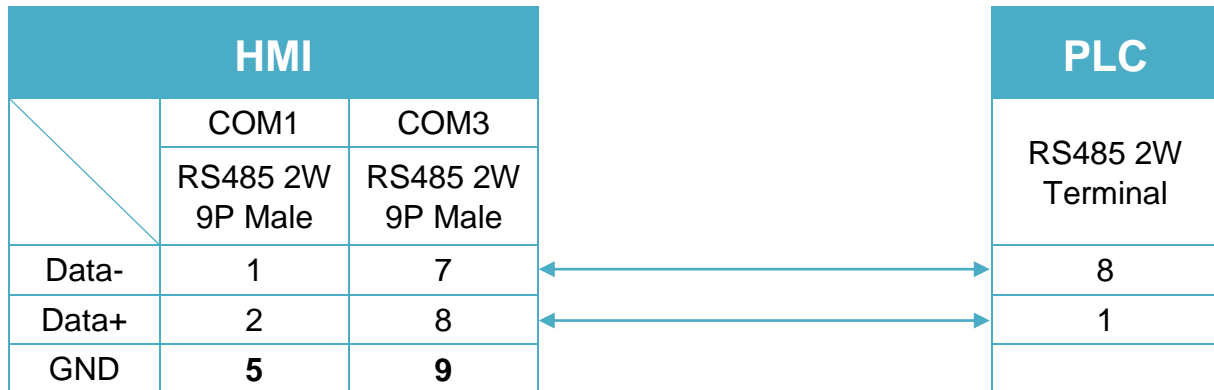


Diagram 4

MT-iE *MT8071iE / MT6071iE / MT8072iE / MT6072iE / MT8073iE / MT8101iE / MT8102iE / MT8103iE*

MT-XE *MT8090XE / MT8092XE*

MT-iP *MT6103iP*

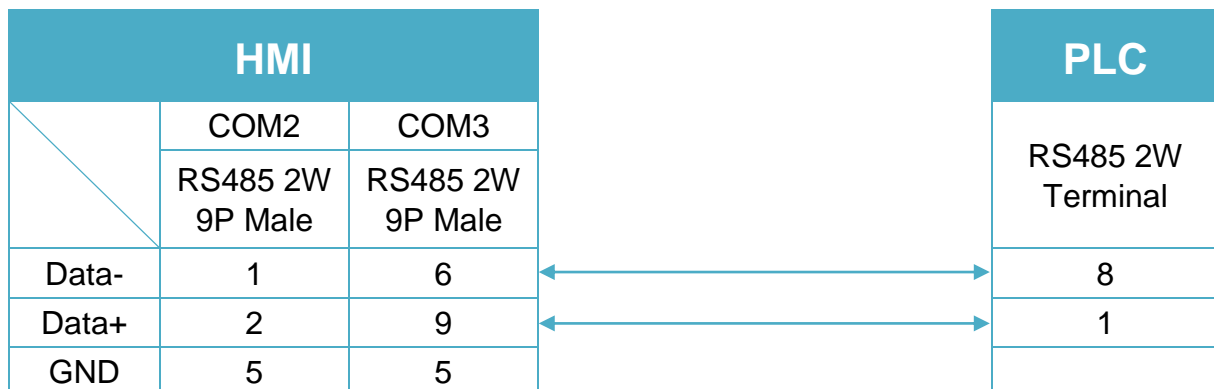
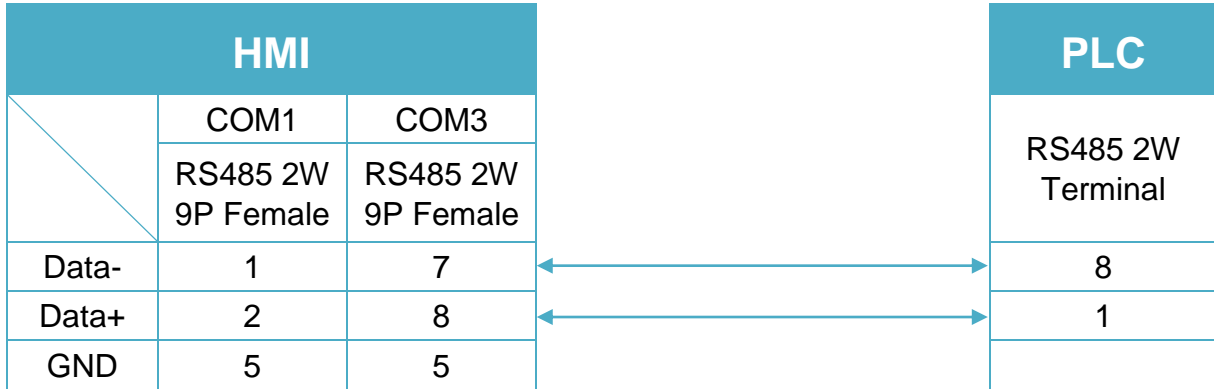
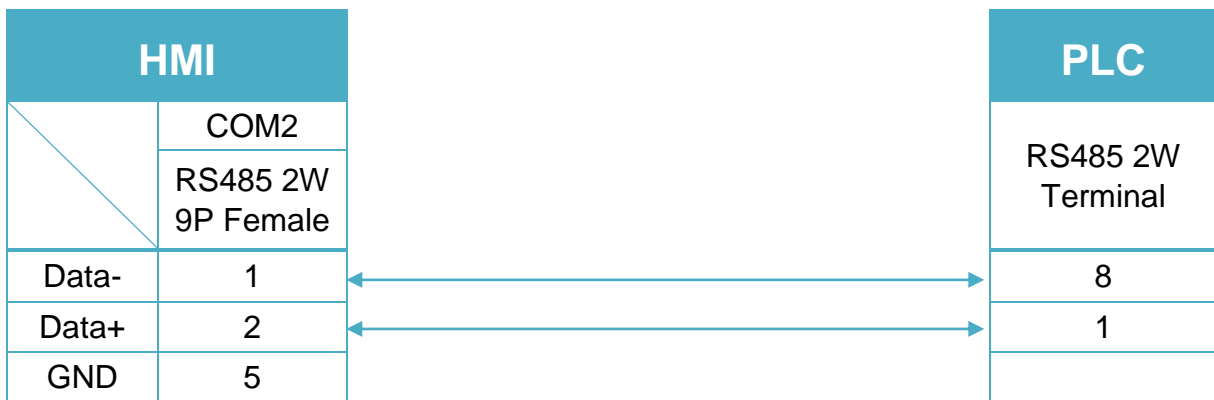


Diagram 5
MT-iE *MT8050iE*
MT-iP *MT6051iP*

Diagram 6
MT-iP *MT6071iP / MT8071iP*


SEW Movilink

Supported Series: SEW Eurodrive series, model MOVITRAC-07 inverter, MovitracB.

Website: <http://sg.sew-eurodrive.com/>

HMI Setting:

Parameters	Recommended	Options	Notes
PLC type	SEW Movilink		
PLC I/F	RS485 2W		
Baud rate	9600		
Data bits	8		
Parity	Even		
Stop bits	1		
PLC sta. no.	0	0~255	

Device Address:

Bit/Word	Device type	Format	Range	Memo
B	INDEX_Bit	DDDDDDDDdd	0 ~ 2552500031	
W	INDEX	DDDDDDDD	0 ~ 25525000	

- The MOVITRAC-07 doesn't support Sub index (other series may support) , please input 000.
- When input D and d, the correct format : Sub index 15, Index 8359, Format is 01508359.

Wiring Diagram:

The following is the view from the soldering point of a cable.



Diagram 1

cMT Series

cMT3151

eMT Series

eMT3070 / eMT3105 / eMT3120 / eMT3150

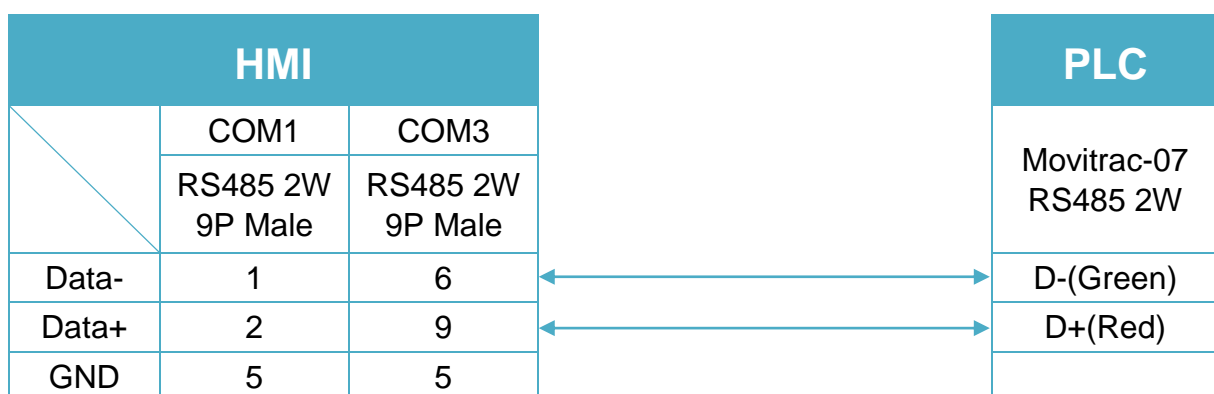


Diagram 2

cMT Series

cMT-SVR

mTV

mTV

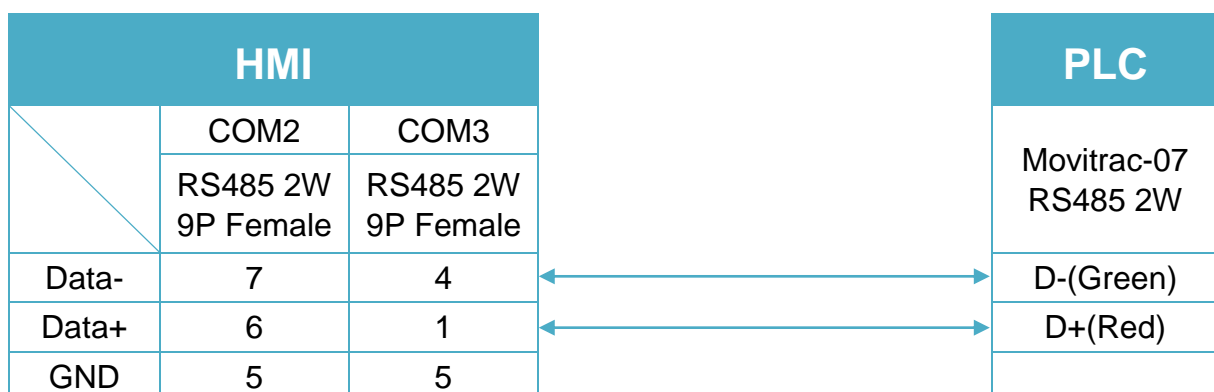


Diagram 3

MT-iE *MT8070iE / MT6070iE / MT8100iE / MT8121iE / MT8150iE*

MT-XE *MT8121XE / MT8150XE*

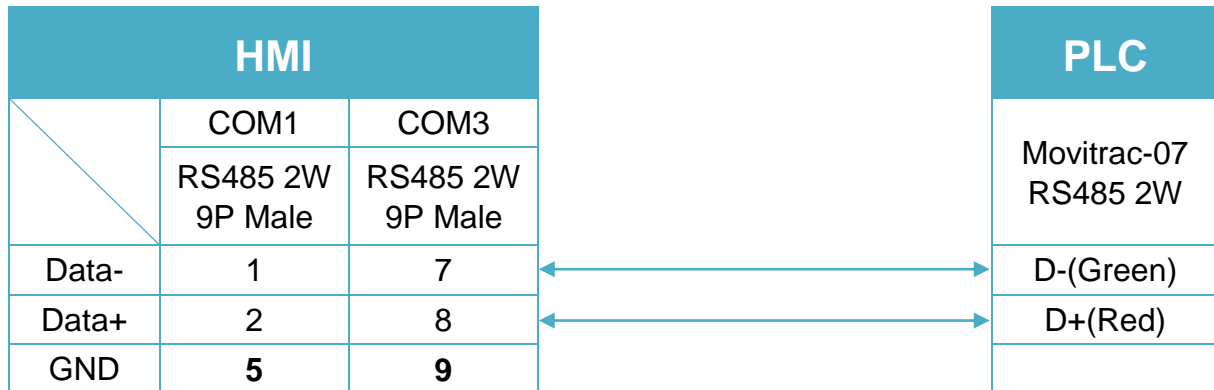


Diagram 4

MT-iE *MT8071iE / MT6071iE / MT8072iE / MT6072iE / MT8073iE /
MT8101iE / MT8102iE / MT8103iE*

MT-XE *MT8090XE / MT8092XE*

MT-iP *MT6103iP*

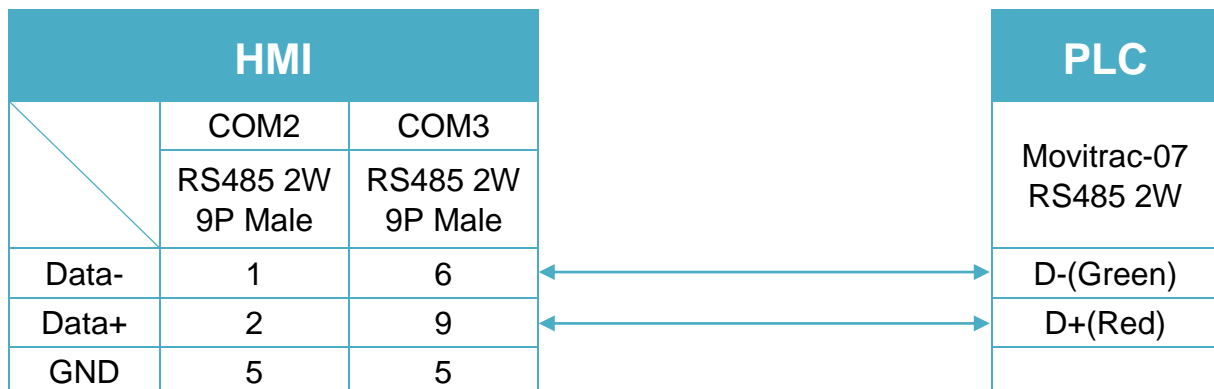


Diagram 5

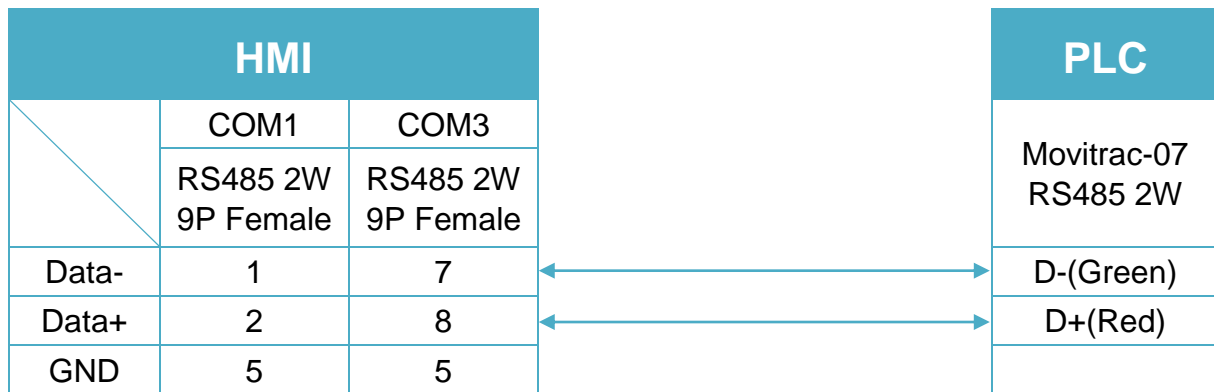
MT-iE *MT8050iE*
MT-iP *MT6051iP*


Diagram 6

MT-iP *MT6071iP / MT8071iP*


SEW MOVITRAC LTE

Website : <http://www.seweurodrive.com/index.php>

HMI Setting:

Parameters	Recommended	Options	Notes
PLC type	SEW MOVITRAC LTE		
PLC I/F	RS-485 2W		
Baud rate	115200		
Data bits	8		
Parity	None		
Stop bits	1		
PLC sta. no.	1		

Online simulator	YES	Extend address mode	NO
------------------	-----	---------------------	----

Device Address:

Bit/Word	Device type	Format	Range	Memo
W	P-1	D	0 ~ 1	Max. speed limit
W	P-2	D	0 ~ 1	Min. speed limit
W	P-3	D	0 ~ 1	Acceleration ramp time
W	P-4	D	0 ~ 1	Deceleration ramp time
W	P-5	D	0 ~ 1	Stop mode select
W	P-6	D	0 ~ 1	Energy optimizer
W	P-7	D	0 ~ 1	Motor rated voltage
W	P-8	D	0 ~ 1	Motor rated current
W	P-9	D	0 ~ 1	Motor rated frequency
W	P-10	D	0 ~ 1	Motor rated speed
W	P-11	D	0 ~ 1	Voltage boost
W	P-12	D	0 ~ 1	Terminal / Keypad control
W	P-13	D	0 ~ 1	Trip log
W	P-14	D	0 ~ 1	Extended menu access code
W	P-15	D	0 ~ 1	Digital input function set
W	P-16	D	0 ~ 1	Analog input V / mA
W	P-17	D	0 ~ 1	Output switching frequency

Bit/Word	Device type	Format	Range	Memo
W	P-18	D	0 ~ 1	User relay output select
W	P-19	D	0 ~ 1	User relay output limit
W	P-20	D	0 ~ 1	Preset speed 1
W	P-21	D	0 ~ 1	Preset speed 2
W	P-22	D	0 ~ 1	Preset speed 3
W	P-23	D	0 ~ 1	Preset speed 4
W	P-24	D	0 ~ 1	Deceleration ramp time 2
W	P-25	D	0 ~ 1	Analog output function select
W	P-26	D	0 ~ 1	Skip frequency hysteris band
W	P-27	D	0 ~ 1	Skip frequency
W	P-28	D	0 ~ 1	V/F characteristic adjustment voltage
W	P-29	D	0 ~ 1	V/F characteristic adjustment frequency
W	P-30	D	0 ~ 1	Terminal mode restart function
W	P-31	D	0 ~ 1	Keypad mode restart function
W	P-32	D	0 ~ 1	DC injection enable / duration
W	P-33	D	0 ~ 1	Spin start
W	P-34	D	0 ~ 1	Brake chopper enable
W	P-35	D	0 ~ 1	Analog input scaling factor
W	P-36	D	0 ~ 1	Comms address; SBus enable/baudrate select; Trip enable / delay
W	P-37	D	0 ~ 1	Access code definition
W	P-38	D	0 ~ 1	Parameter access lock
W	P-39	D	0 ~ 1	Analog input off-set
W	P-40	D	0 ~ 1	Display speed scaling factor
W	P-00-01	D	0 ~ 1	Analog input 1 value
W	P-00-02	D	0 ~ 1	Analog input 2 value
W	P-00-03	D	0 ~ 1	Speed reference input
W	P-00-04	D	0 ~ 1	Digital input status
W	P-00-05	D	0 ~ 1	Reserved
W	P-00-06	D	0 ~ 1	Reserved
W	P-00-07	D	0 ~ 1	Applied motor voltage
W	P-00-08	D	0 ~ 1	DC bus voltage log
W	P-00-09	D	0 ~ 1	Heatsink temperature
W	P-00-10	D	0 ~ 1	Hours run meter
W	P-00-11	D	0 ~ 1	Run time since last trip (1)
W	P-00-12	D	0 ~ 1	Run time since last trip (2)
W	P-00-13	D	0 ~ 1	Run time since last disable

Bit/Word	Device type	Format	Range	Memo
W	P-00-14	D	0 ~ 1	Reserved
W	P-00-15	D	0 ~ 1	DC bus voltage log
W	P-00-16	D	0 ~ 1	Thermistor temperature log
W	P-00-17	D	0 ~ 1	Motor current
W	P-00-18	D	0 ~ 1	Software ID,IO and motor control
W	P-00-19	D	0 ~ 1	Drive serial number
W	P-00-20	D	0 ~ 1	Drive identifier

P-00-01 ~ P-00-20 read only.

Wiring Diagram:

Diagram 1

cMT Series

cMT3151

eMT Series

eMT3070 / eMT3105 / eMT3120 / eMT3150

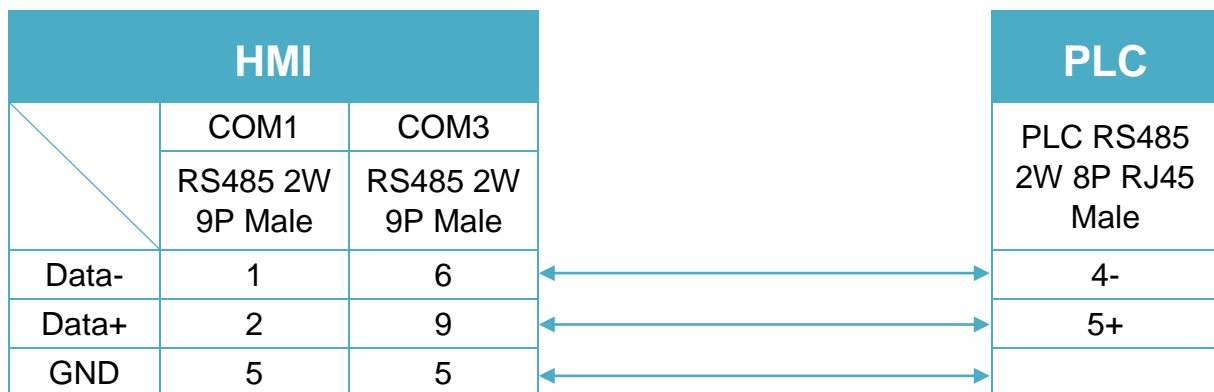


Diagram 2

cMT Series

cMT-SVR

mTV

mTV

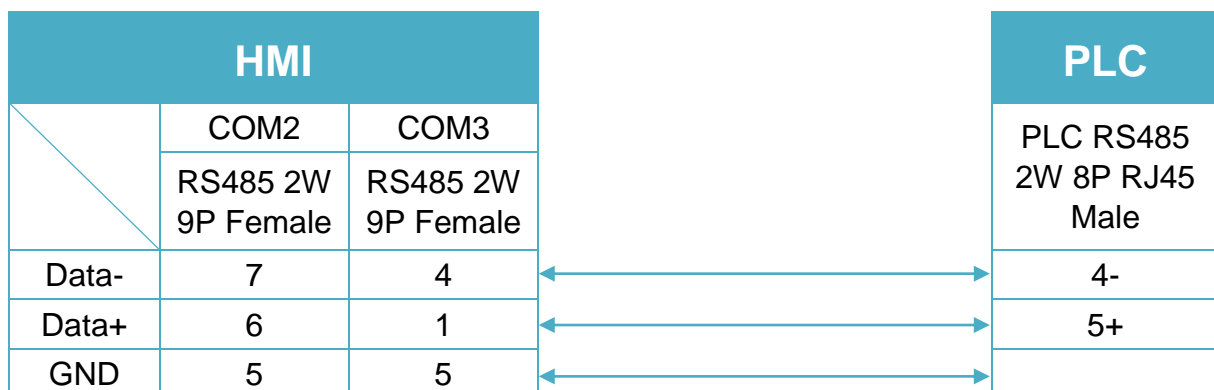


Diagram 3

MT-iE *MT8070iE / MT6070iE / MT8100iE / MT8121iE / MT8150iE*

MT-XE *MT8121XE / MT8150XE*

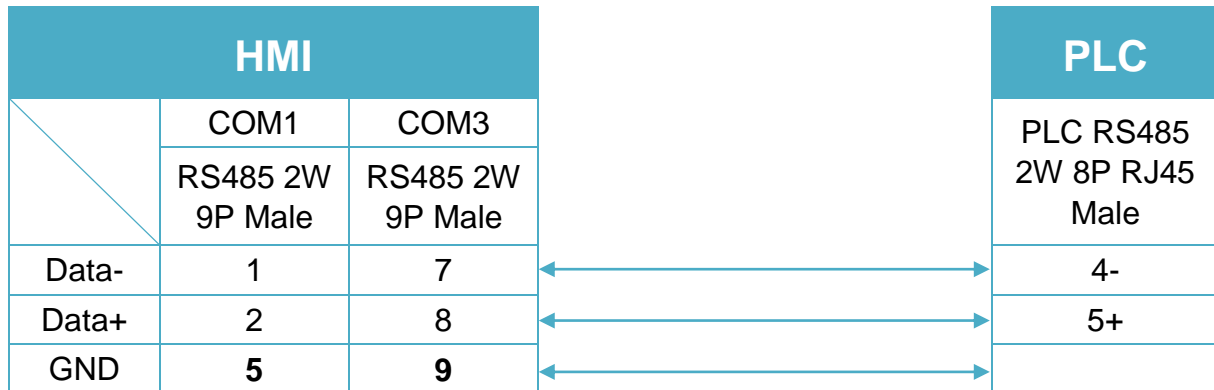


Diagram 4

MT-iE *MT8071iE / MT6071iE / MT8072iE / MT6072iE / MT8073iE /
MT8101iE / MT8102iE / MT8103iE*

MT-XE *MT8090XE / MT8092XE*

MT-iP *MT6103iP*

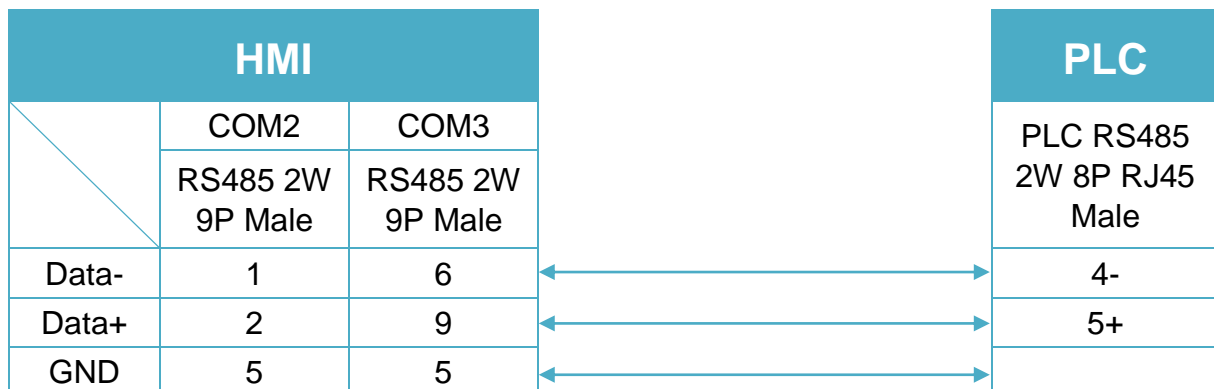
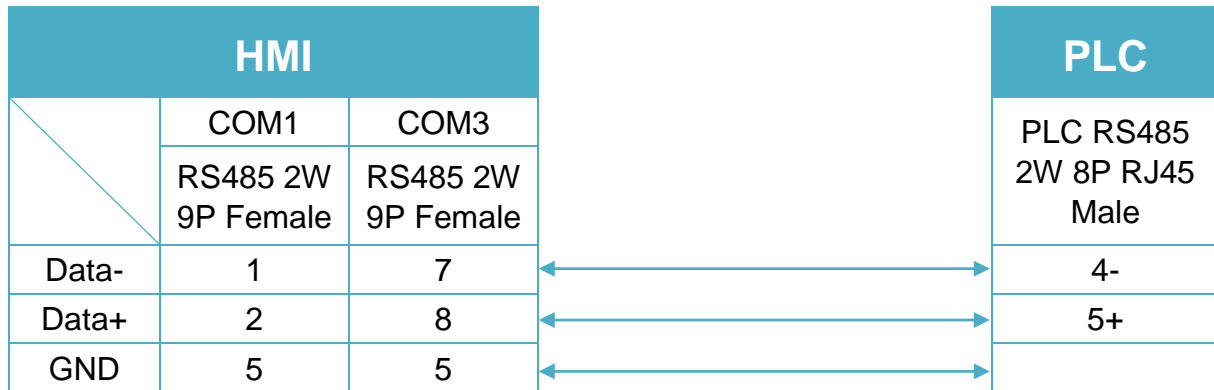
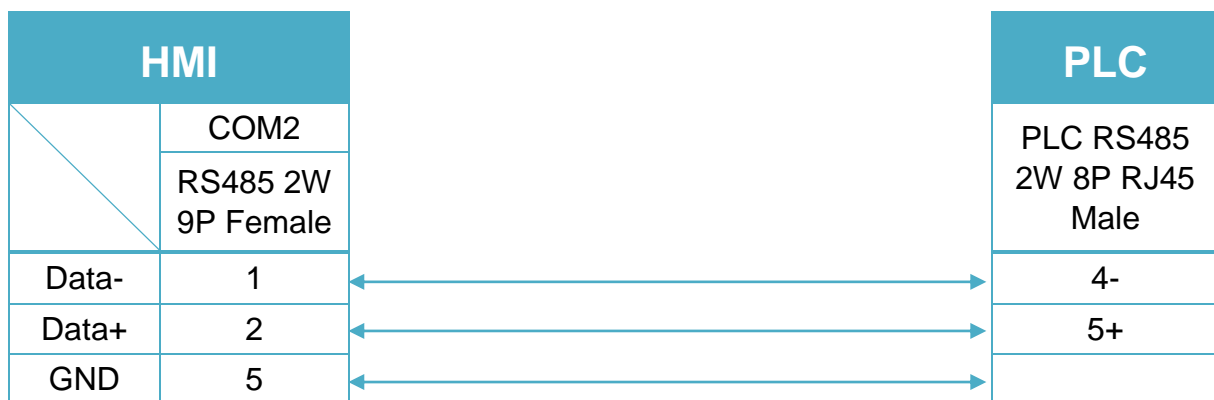


Diagram 5
MT-iE *MT8050iE*
MT-iP *MT6051iP*

Diagram 6
MT-iP *MT6071iP / MT8071iP*


SHIMADEN MR13/FP93

Supported Series: MR13, FP93 devices

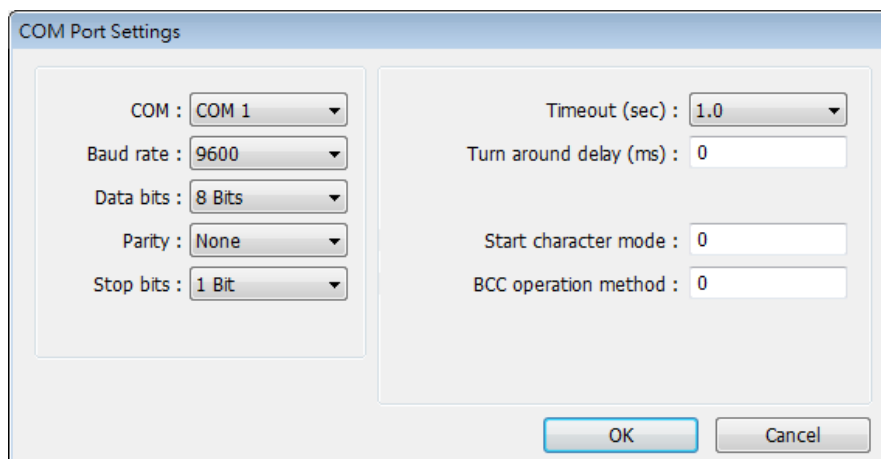
Website: <http://www.shimaden.co.jp>

HMI Setting:

Parameters	Recommended	Options	Notes
PLC type	SHIMADEN MR13/FP93		
PLC I/F	RS485 2W		
Baud rate	9600	1200-19200	
Data bits	7	7 or 8	
Parity	E	None/Even	
Stop bits	1	1	
PLC sta. no.	1	1~255	
Start Character Mode	Select 3 : @ _ : _ CR	0, 1 : STX_ETX_CR 2 : STX_ETX_CR LF 3 : @ _ : _ CR	For FP93, select 0,1
BCC Operation Method	Select 3 : XOR	0, 1 : Addition 2 : Addition +2's complement 3 : XOR 4 : None	

Note :

Address 018C is a communication control register, only when it is set to 1 can this register be allowed to write to other registers.



COM Port Settings

COM : COM 1

Baud rate : 9600

Data bits : 8 Bits

Parity : None

Stop bits : 1 Bit

Timeout (sec) : 1.0

Turn around delay (ms) : 0

Start character mode : 0

BCC operation method : 0

OK Cancel

Device Address:

Bit/Word	Device	Format	Range	Memo
W	Channel 1	HHHH	0 ~ ffff	Read/Write 1st Channel Register
W	Channel 2	HHHH	0 ~ ffff	Read/Write 2nd Channel Register
W	Channel 3	HHHH	0 ~ ffff	Read/Write 3rd Channel Register

Wiring Diagram:

Diagram 1

cMT Series *cMT3151*

eMT Series *eMT3070 / eMT3105 / eMT3120 / eMT3150*

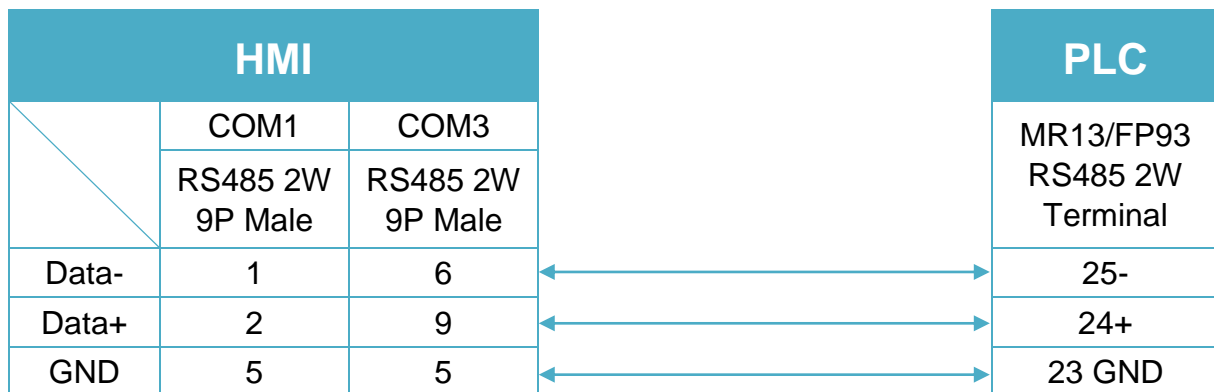


Diagram 2

cMT Series *cMT-SVR*

mTV *mTV*

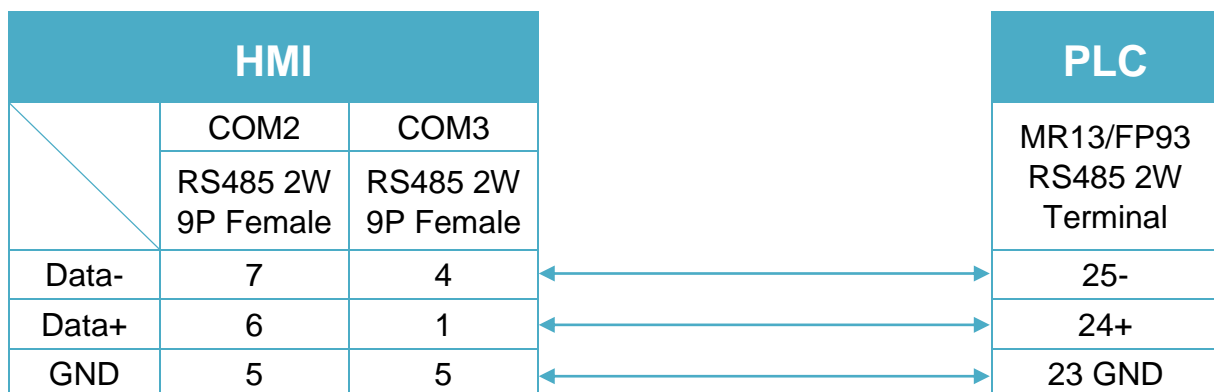


Diagram 3

MT-iE *MT8070iE / MT6070iE / MT8100iE / MT8121iE / MT8150iE*

MT-XE *MT8121XE / MT8150XE*

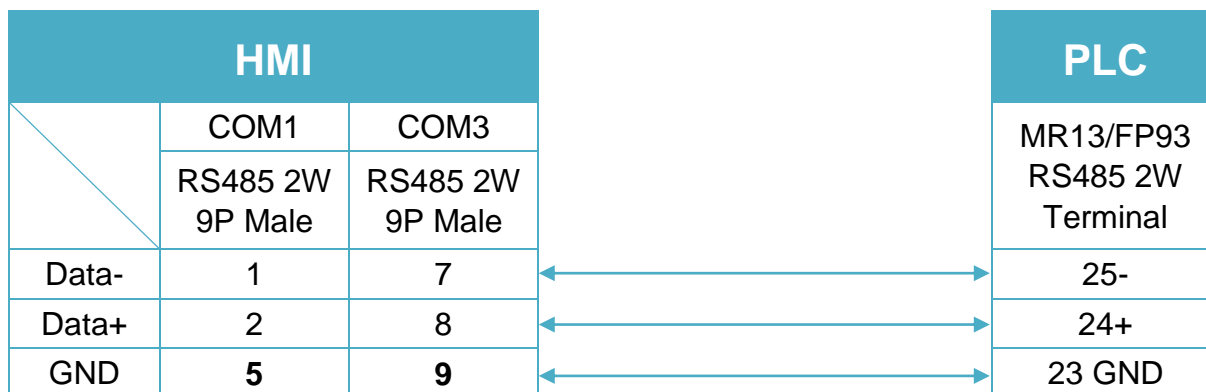


Diagram 4

MT-iE *MT8071iE / MT6071iE / MT8072iE / MT6072iE / MT8073iE /
MT8101iE / MT8102iE / MT8103iE*

MT-XE *MT8090XE / MT8092XE*

MT-iP *MT6103iP*

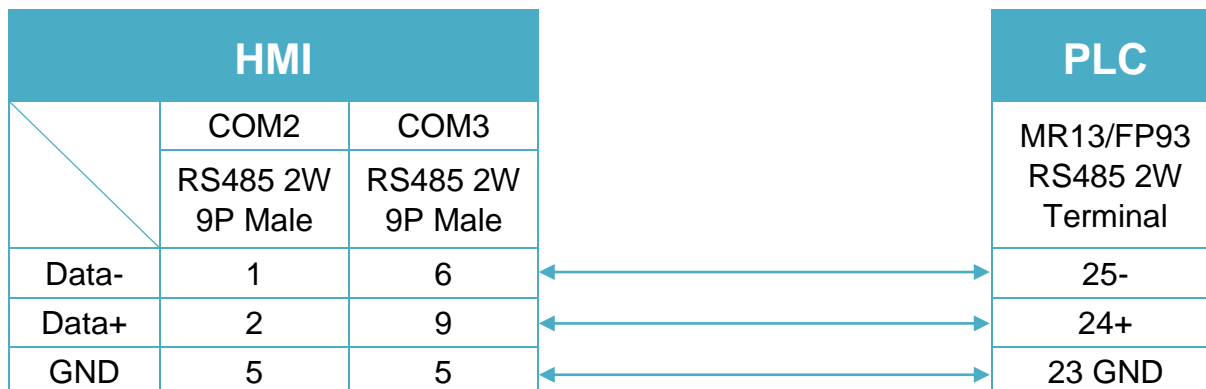


Diagram 5

MT-iE *MT8050iE*

MT-iP *MT6051iP*

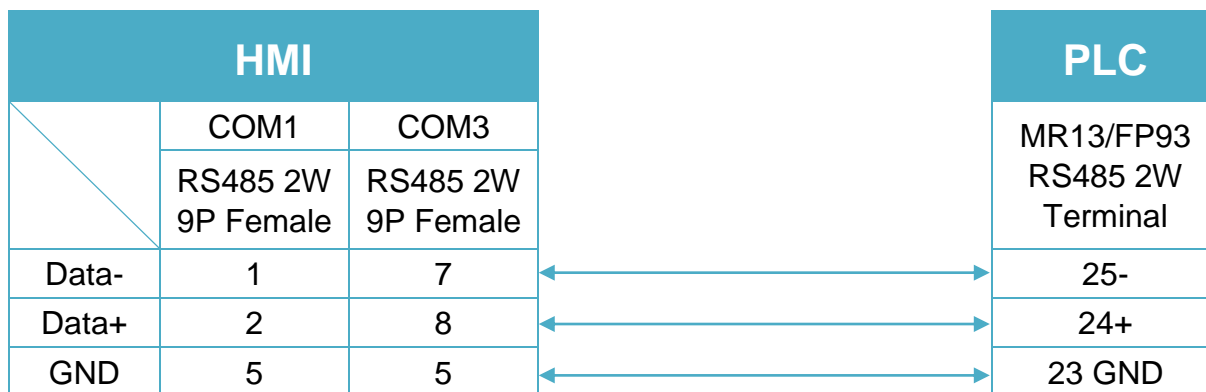


Diagram 6

MT-iP *MT6071iP / MT8071iP*



MR13 Communication Parameter Settings

Data Address	Parameter	Details of Parameter	R /W
0100	PV Value	Within measuring range	R
0101	E_SV Execution SV Value	Within setting range	R
0102	OUT Control Output Value	Within range 0.0~100.0%	R
0103	Reserved		

0104	Action Flag	(See detailed explanation below.)	R
0105	Event Output Flag	(See detailed explanation below.)	R
0106	Reserved		
0107	Reserved		
0108	REM Value	Within setting range	R
0109	Reserved		
010A	Reserved		
010B	DI Input State Flag	(See detailed explanation below.)	R
Data Address (hex)	Parameter	Details of Parameter	R /W
0111	RANGE	Refer to the measuring range code list.	R
0112	Reserved		
0113	DP Decimal Point	Position of decimal point (0:Without decimal point 1:With decimal point)	R
0114	PV Sc_L Lower Limit	For Linear Input:-1999~9999 unit For Thermocouple, and RTD Input: Measuring range to be displayed.	R
0115	PV Sc_H Higher Limit		R

Data Address (hex)	Parameter	Details of Parameter	R/W
0120	E_PRG	Program Action Flag	R
0121	Reserved		
0122	Reserved		
0123	E_PRT	The number of execution patterns (When program is reset, value=7FFEh)	R
0124	E_STP	Execution step number (When program is reset, value=7FFEh)	R
0125	E_TIM	Remaining time of execution step (When program is reset, value=7FFEh)	R
0126	E_PID	Execution PID number (When program is reset, value=7FFEh)	R

Data Address	Parameter	Details of Parameter	R/W
0184	AT Auto Tuning	0:No execution 1:Execution	W

018C	Operation	0:Local 1:COM	W
------	-----------	------------------	---

0190	PROG RUN/RST Program Run/Reset	0 : RST, 1 : RUN (Writing is possible only in CH1)	W
------	-----------------------------------	---	---

0191	PROG HLD Program Hold	0 : Release, 1 : HLD (Writing is possible only in CH1)	W
------	--------------------------	---	---

0300	SV	Local SV Value, within set value limiter	R/W
------	----	--	-----

Data Address	Parameter	Details of Parameter	R/W
030A	SV Limt_L Lower Limit	Within measuring range, On condition that SV Limt_L<SV Limt_H	R/W
030B	SV Limt_h Higher Limit		

0314	REM SC_L	Within measuring range On condition that REM SC_L ≠ REM SC_H	R/W
0315	REM SC_H		
0316	REM Bias	Range: -1999~5000 unit	R/W
0317	REM Filt	Range: 0~100 seconds	R/W

031A	REM-CH	Remote channel assignment 0 : OFF , 1 : CH1 , 2 : CH2 , 3 : CH3	R/W
------	--------	--	-----

Data Address	Parameter	Details of Parameter	R/W
0320	SV Follow SW	CH2 & CH3 SV follow setting flag 1: Follow 0:No	R/W

Data Address	Parameter	Details of Parameter	R/W
0321	SV Follow	Follow type deviation SV set value: 1999~5000 unit	R/W

0400	FIX P	Control Output Proportional Baud Range: 0.0~999.9%(0.0:OFF)	R/W
0401	FIX I	Control Output Integral Time Range: 0~6000 Seconds (0.0:OFF)	R/W
0402	FIX D	Control Output Derivative Time Range 0~3600 Seconds (0.0:OFF)	R/W
0403	FIX MR	Manual Reset Range: -50.0~50.0%	R/W
0404	FIX DF	Hysteresis Range: 1~999 unit	R/W
0405	FIX OUT Limt_L	Control Output Lower Limit Output Limiter Range: 0.0~99.9%	R/W
0406	FIX OUT Limt_H	Control Output Higher Limit Output Limiter Range: 0.1~100.0%	R/W
0407	FIX SF	Control Output Target Value Function Range: OFF , 0.01~1.00	R/W
0408	Prog P1	PROG mode PB1 Range: 0.0~999.9% (0.0:OFF)	R/W
0409	Prog I1	PROG mode IT1 Range: 0~6000 seconds (0.0:OFF)	R/W
040A	Prog D1	PROG mode DT1 Range: 0~3600 seconds (0.0:OFF)	R/W
040B	Prog MR1	PROG mode MR1 Range: -50.0~50.0%	R/W
040C	Prog DF1	PROG mode DF1 Range: 1~999 unit	R/W
040D	Prog O_Lmt_L1	PROG mode lower limit side output limiter 1 Range: 0.0~99.9%	R/W
040E	Prog O_Lmt_H1	PROG mode higher limit side output limiter 1 Range: 0.1~100.0%	R/W
040F	Prog SF1	PROG mode target value function 1 Range: OFF,0.01~1.00	R/W
0410	Prog P2	PROG mode PB2 Range: 0.0~999.9% (0.0:OFF)	R/W

0411	Prog I2	PROG mode IT2 Range: 0~6000 seconds (0.0:OFF)	R/W
0412	Prog D2	PROG mode DT2 Range: 0~3600 seconds (0.0:OFF)	R/W
0413	Prog MR2	PROG mode MR2 Range: -50.0~50.0%	R/W
0414	Prog DF2	PROG mode DF2 Range: 1~999 unit	R/W
0415	Prog O_Lmt_L2	PROG mode lower limit side output limiter 2 Range: 0.0~99.9%	R/W
0416	Prog O_Lmt_H2	PROG mode higher limit side output limiter 2 Range: 0.1~100.0%	R/W
0417	Prog SF2	PROG mode target value function 2 Range: OFF,0.01~1.00	R/W
0418	Prog P3	PROG mode PB3 Range: 0.0~999.9% (0.0:OFF)	R/W
0419	Prog I3	PROG mode IT3 Range: 0~6000 seconds (0.0:OFF)	R/W
041A	Prog D3	PROG mode DT3 Range: 0~3600 seconds (0.0:OFF)	R/W
041B	Prog MR3	PROG mode MR3 Range: -50.0~50.0%	R/W
041C	Prog DF3	PROG mode DF3 Range: 1~999 unit	R/W
041D	Prog O_Lmt_L3	PROG mode lower limit side output limiter 3 Range: 0.0~99.9%	R/W
041E	Prog O_Lmt_H3	PROG mode higher limit side output limiter 3 Range: 0.1~100.0%	R/W
041F	Prog SF3	PROG mode target value function 3 Range: OFF,0.01~1.00	R/W

0500	EV1_MODE	0:Not assigned 1:Higher limit deviation value 2:Lower limit deviation value 3:Out of range between higher & lower limits 4:Within range between higher & lower limits 5:Higher limit absolute value 6:Lower limit absolute value 7:Scaleover 8:Program RUN 9:Program END 10:Program STEP Only when Subaddress=EV1_CH.	R/W
0501	EV1 Set Point	1. Higher limit deviation value alarm: 0~1999 unit 2. Lower limit deviation value alarm: 0~-1999 unit 3. Out of range between higher & lower limits value alarm: 0~1999 unit 4. Within range between higher and lower limits value alarm: 0~1999 unit 5. Higher limit absolute value alarm: Within measuring range 6. Lower limit absolute value alarm: Within measuring range Only when Subaddress=EV1_CH.	R/W
0502	EV1 Diffrent	Alarm hysteresis 1~999 unit Only when Subaddress=EV1_CH.	R/W
0503	EV1 Inhibit	Alarm stand by 1~4 Only when Subaddress=EV1_CH.	R/W
0504	EV1 Delay	Alarm delay time 0~9999 seconds Only when Subaddress=EV1_CH.	R/W
0506	EV1_CH	Channel number setting 1:CH1, 2:CH2, 3:CH3	R/W

0510	EV2_MODE	0:Not assigned 1:Higher limit deviation value 2:Lower limit deviation value 3:Out of range between higher & lower limits 4:Within range between higher & lower limits 5:Higher limit absolute value 6:Lower limit absolute value 7:Scaleover 8:Program RUN 9:Program END 10:Program STEP Only when Subaddress=EV2_CH.	R/W
0511	EV2 Set Point	1. Higher limit deviation value alarm: 0~1999 unit 2. Lower limit deviation value alarm: 0~-1999 unit 3. Out of range between higher & lower limits value alarm: 0~1999 unit 4. Within range between higher and lower limits value alarm: 0~1999 unit 5. Higher limit absolute value alarm: Within measuring range 6. Lower limit absolute value alarm: Within measuring range Only when Subaddress=EV2_CH.	R/W
0512	EV2 Diffrent	Alarm hysteresis 1~999 unit Only when Subaddress=EV2_CH.	R/W
0513	EV2 Inhibit	Alarm stand by 1~4 Only when Subaddress=EV2_CH.	R/W
0514	EV2 Delay	Alarm delay time 0~9999 seconds Only when Subaddress=EV2_CH.	R/W
0516	EV2_CH	Channel number setting 1:CH1, 2:CH2, 3:CH3	R/W

0520	EV3_MODE	0:Not assigned 1:Higher limit deviation value 2:Lower limit deviation value 3:Out of range between higher & lower limits 4:Within range between higher & lower limits 5:Higher limit absolute value 6:Lower limit absolute value 7:Scaleover 8:Program RUN 9:Program END 10:Program STEP Only when Subaddress=EV3_CH.	R/W
0521	EV3 Set Point	1. Higher limit deviation value alarm: 0~1999 unit 2. Lower limit deviation value alarm: 0~-1999 unit 3. Out of range between higher & lower limits value alarm: 0~1999 unit 4. Within range between higher and lower limits value alarm: 0~1999 unit 5. Higher limit absolute value alarm: Within measuring range 6. Lower limit absolute value alarm: Within measuring range Only when Subaddress=EV3_CH	R/W
0522	EV3 Diffrent	Alarm hysteresis 1~999 unit Only when Subaddress=EV3_CH.	R/W
0523	EV3 Inhibit	Alarm stand by 1~4 Only when Subaddress=EV3_CH.	R/W
0524	EV3 Delay	Alarm delay time 0~9999 seconds Only when Subaddress=EV3_CH.	R/W

0526	EV3_CH	Channel number setting 1:CH1, 2:CH2, 3:CH3	R/W
------	--------	---	-----

0580	DI	DI setting flag 0:NON 1:FLW 2:RUN 3:HLD 4:ADV	R/W
------	----	---	-----

05B0	MEM	1:EEP Program Memory 0:RAM Random Memory	R/W
------	-----	---	-----

0600	Out Actn	Output characteristic setting flag 0:Rev Act. 1:Dir Act	R/W
0601	Out Cyc	Control output cycle (Unit:0.5 seconds) Range: 0.5~120.0 seconds	R/W
0602	Reserved		
0603	SOFTSW	Soft start setting flag 0:OFF 1:ON	

0610	AT Point	AT pointer Range: 0~5000 unit	R/W
0611	Key Lock	0:OFF 1:LOCK1 2:LOCK2 3:LOCK3	R/W

- When Out_Cyc is written, writing data is adjusted to 0.5 sec as one unit.
- The write command lock by keylock is the same as the screen lock. (Refer to the manual of the instrument.)
- If there is a change in EV1_CH, EV2_CH, EV3_CH, the related parameters are initialized.

0701	PV Bias	PV bias Range: -1999~1999 unit	R/W
0702	PV Filt	PV filter Range: 0~100 seconds	R/W

0710	PFLW	Setting of CH2, CH3 PV input follow 0:OFF 1:ON	R/W
0711	CH_P	Selection of CH2, CH3 PV display or not 0-0 Window 0: Without 1: With	R/W

0800	FP_MOD	Selection between FIX and PROG 0:FIX 1:PROG (Writing possible only in CH1)	R/W
0801	PV_ST	Setting of PV start 0:OFF 1:ON (Writing possible only in CH1)	R/W

0882	STP	The number of steps 1~9 (Writing possible only in CH1)	R/W
0883	RPT	The number of execution repetitions 1~9999 (Writing possible only in CH1)	R/W
0884	ST_SV	Start SV (Writing possible only in CH1)	R/W

- For CH1, PFLW (window 1~30), CH_P (window1-29) display- - - .The read value is: 7FFEh, To a write command, error (0BH) is returned.

08A0	Step1 SV	Step No. 1 SV Value (Writing possible only in CH1)	R/W
08A1	Step1 Time	Step No. 1 Step Time (Writing possible only in CH1)	R/W
08A2	Step1 PID No	Step No. 1 PID No.	R/W
08A3	Reserved		
08A4	Step2 SV	Step No. 2 SV Value (Writing possible only in CH1)	R/W
08A5	Step2 Time	Step No. 2 Step Time (Writing possible only in CH1)	R/W
08A6	Step2 PID No	Step No. 2 PID No.	R/W
08A7	Reserved		
08A8	Step3 SV	Step No. 3 SV Value (Writing possible only in CH1)	R/W
08A9	Step3 Time	Step No. 3 Step Time (Writing possible only in CH1)	R/W
08AA	Step3 PID No	Step No. 3 PID No.	R/W
08AB	Reserved		
08AC	Step4 SV	Step No. 4 SV Value (Writing possible only in CH1)	R/W
08AD	Step4 Time	Step No. 4 Step Time (Writing possible only in CH1)	R/W
08AE	Step4 PID No	Step No. 4 PID No.	R/W
08AF	Reserved		
08B0	Step5 SV	Step No. 5 SV Value (Writing possible only in CH1)	R/W

08B1	Step5 Time	Step No. 5 Step Time (Writing possible only in CH1)	R/W
08B2	Step5 PID No	Step No. 5 PID No.	R/W
08B3	Reserved		
08B4	Step6 SV	Step No. 6 SV Value (Writing possible only in CH1)	R/W
08B5	Step6 Time	Step No. 6 Step Time (Writing possible only in CH1)	R/W
08B6	Step6 PID No	Step No. 6 PID No.	R/W
08B7	Reserved		
08B8	Step7 SV	Step No. 7 SV Value (Writing possible only in CH1)	R/W
08B9	Step7 Time	Step No. 7 Step Time (Writing possible only in CH1)	R/W
08BA	Step7 PID No	Step No. 7 PID No.	R/W
08BB	Reserved		
08BC	Step8 SV	Step No. 8 SV Value (Writing possible only in CH1)	R/W
08BD	Step8 Time	Step No. 8 Step Time (Writing possible only in CH1)	R/W
08BE	Step8 PID No	Step No. 8 PID No.	R/W
08BF	Reserved		
08C0	Step9 SV	Step No. 9 SV Value (Writing possible only in CH1)	R/W
08C1	Step9 Time	Step No. 9 Step Time (Writing possible only in CH1)	R/W
08C2	Step9 PID No	Step No. 9 PID No.	R/W

SHJ-A

HMI Setting:

Parameters	Recommended	Options	Notes
PLC type	SHJ-A		
PLC I/F	RS485 2W		
Baud rate	9600		
Data bits	8		
Parity	None		
Stop bits	1		
PLC sta. no.	0		

Device Address:

Bit/Word	Device type	Format	Range	Memo
W	Word	DD	0 ~ 89	

Wiring Diagram:

Diagram 1

cMT Series

cMT3151

eMT Series

eMT3070 / eMT3105 / eMT3120 / eMT3150

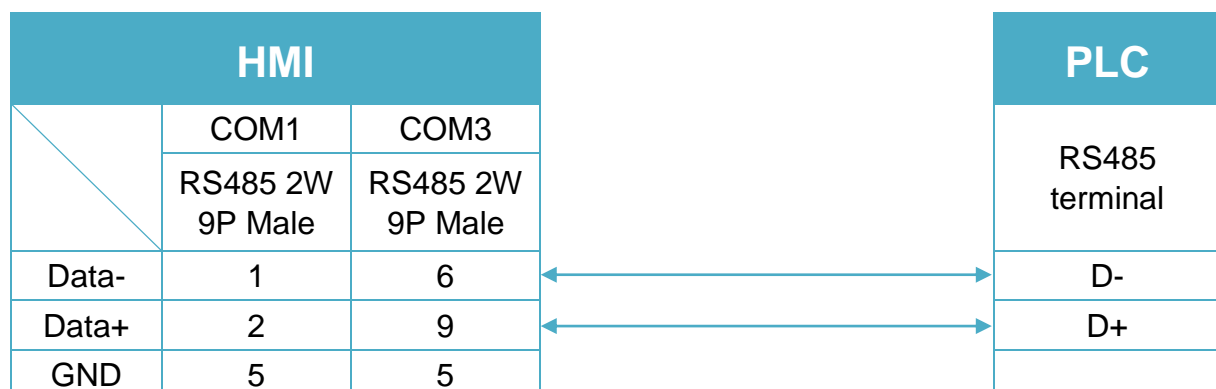


Diagram 2

cMT Series *cMT-SVR*

mTV *mTV*

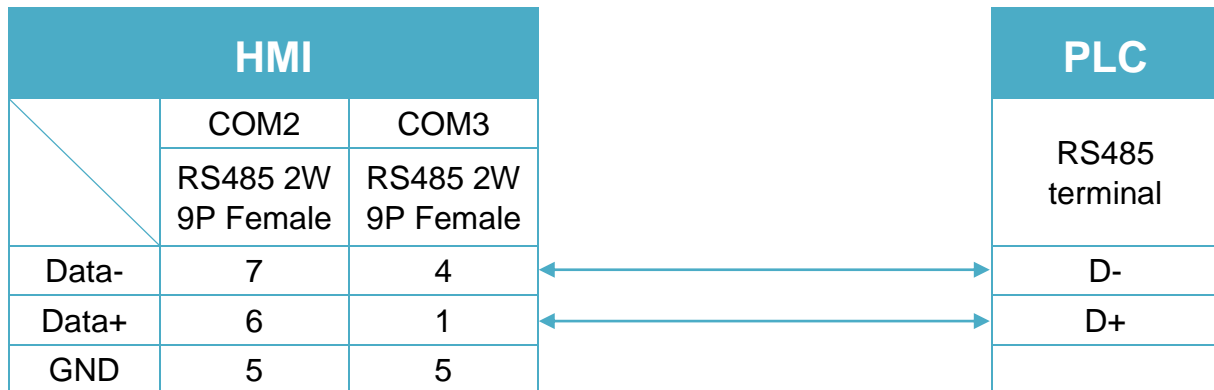


Diagram 3

MT-iE *MT8070iE / MT6070iE / MT8100iE / MT8121iE / MT8150iE*

MT-XE *MT8121XE / MT8150XE*

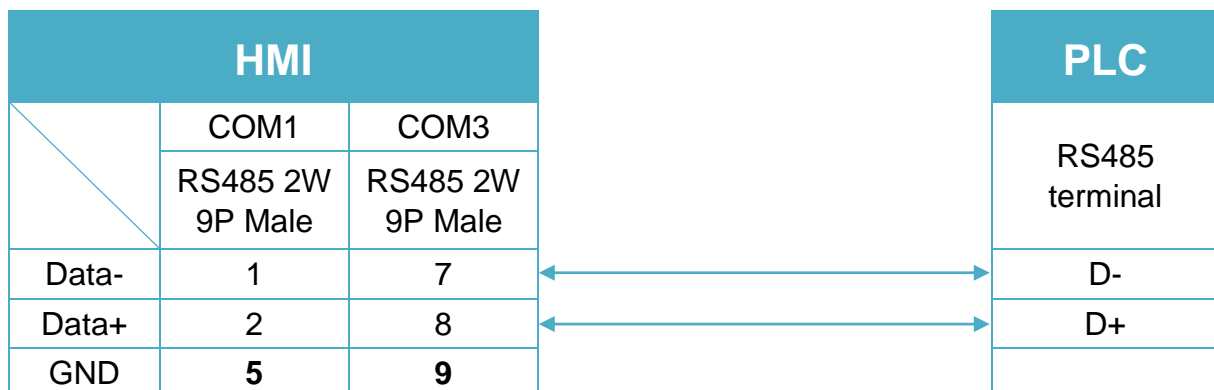
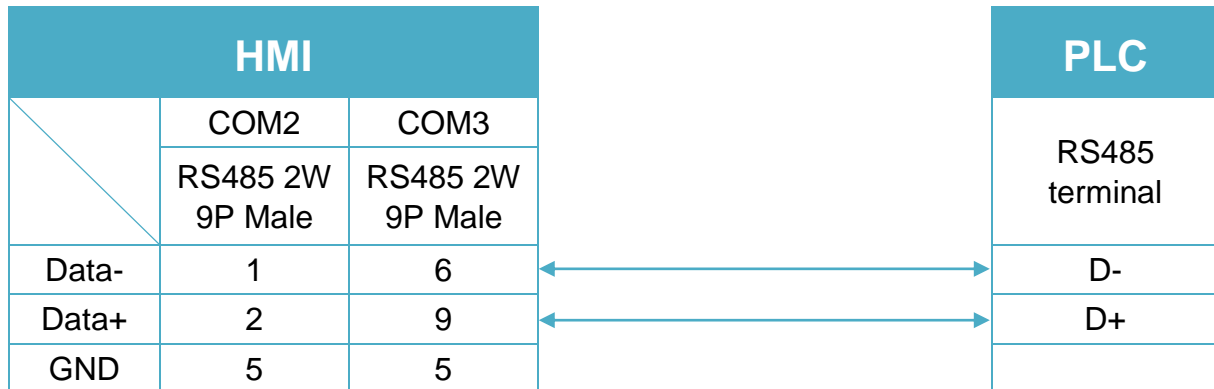


Diagram 4

MT-iE *MT8071iE / MT6071iE / MT8072iE / MT6072iE / MT8073iE /
MT8101iE / MT8102iE / MT8103iE*

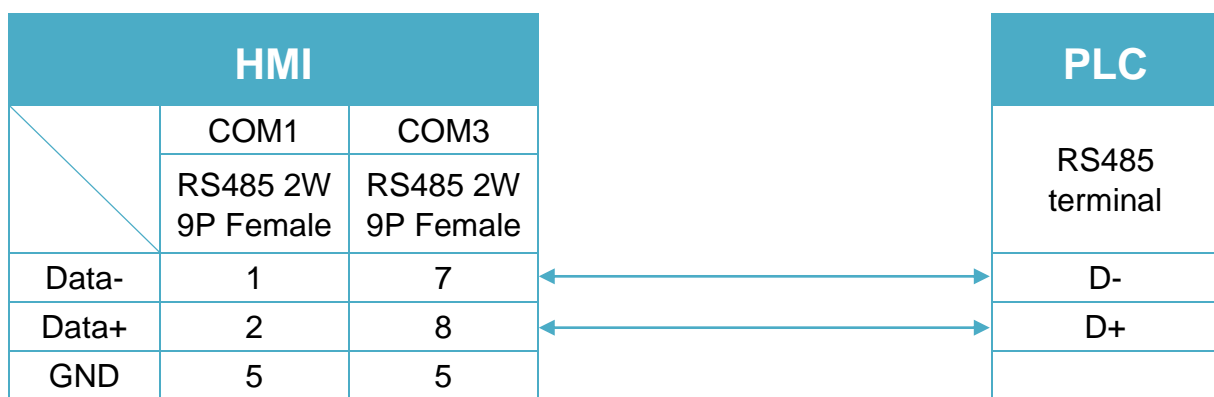
MT-XE *MT8090XE / MT8092XE*

MT-iP *MT6103iP*

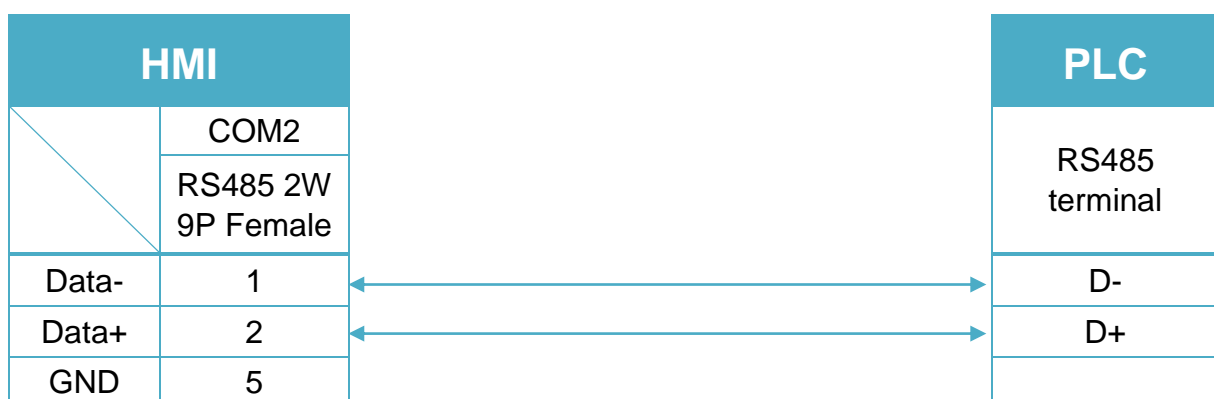

Diagram 5

MT-iE *MT8050iE*

MT-iP *MT6051iP*


Diagram 6

MT-iP *MT6071iP / MT8071iP*



SICK FLEXI SOFT

HMI Setting:

Parameters	Recommended	Options	Notes
PLC type	SICK FLEXI SOFT		
PLC I/F	RS232		
Baud rate	115200	9600,19200,3840 0,57600,115200	
Data bits	8		
Parity	None		
Stop bits	1		
PLC sta. no.	0		

Device Address:

Bit/Word	Device type	Format	Range	Memo
B	I	DDo	0 ~ 127	Input
B	Q	DDo	0 ~ 127	Output
B	Logic result	DDo	0 ~ 47	Logic Result
B	RS-232	DDo	0 ~ 37	RS-232
B	Flexi soft to RS-232_Bit	DDo	0 ~ 997	
B	Module Status Bit Array_Bit	DDo	0 ~ 597	
B	Operating Data Block_Bit	Do	0 ~ 97	
B	Configuration CRCs_Bit	DDo	0 ~ 197	
B	CPU Module Type Key_Bit	DDo	0 ~ 177	
B	Extension Modules Type_Bit	DDDo	0 ~ 3377	
W	RS-232 to Flexi soft	D	0 ~ 2	
W	Flexi soft to RS-232	DD	0 ~ 98	
W	Module Status Bit Array	DD	0 ~ 58	
W	Operating Data Block	D	0 ~ 8	
W	Configuration CRCs	DD	0 ~ 18	
W	CPU Module Type Key	DD	0 ~ 16	
W	Extension Modules Type	DDD	0 ~ 336	

Wiring Diagram:

The following is the view from the soldering point of a cable.



Diagram 1

cMT Series	<i>cMT3151</i>
eMT Series	<i>eMT3070 / eMT3105 / eMT3120 / eMT3150</i>
MT-iE	<i>MT8073iE / MT8102iE</i>
MT-XE	<i>MT8092XE</i>
MT-iP	<i>MT6103iP</i>

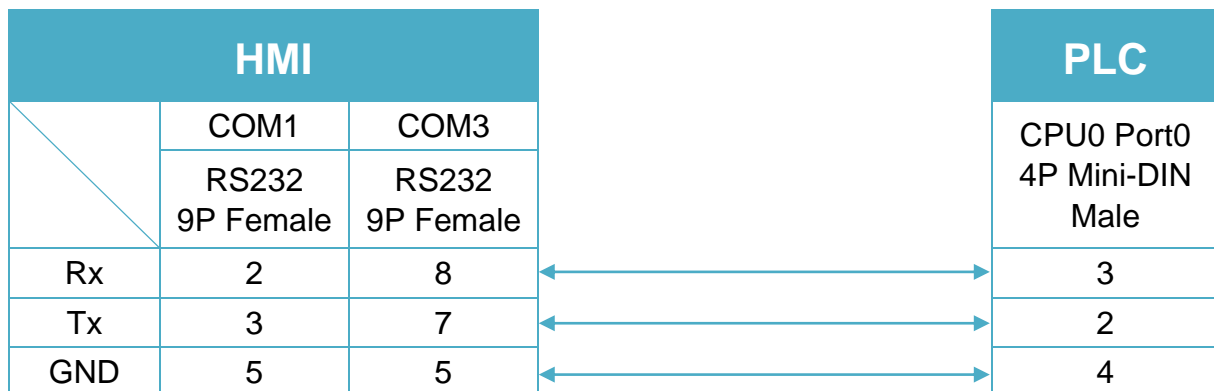


Diagram 2

cMT Series	cMT-SVR
mTV	mTV
MT-iE	MT8070iE / MT6070iE / MT8100iE / MT8121iE / MT8150iE / MT8071iE / MT6071iE / MT8072iE / MT6072iE / MT8073iE / MT8101iE / MT8102iE / MT8103iE
MT-XE	MT8121XE / MT8150XE / MT8090XE



Diagram 3

MT-iE	MT8050iE
MT-iP	MT6051iP / MT6071iP / MT8071iP



Siemens LOGO (Ethernet)

Supported Series: Siemens LOGO! 0BA7,0BA8

Website: <http://www.siemens.com/entry/cc/en/>

HMI Setting:

Parameters	Recommended	Options	Notes
PLC type	Siemens LOGO (Ethernet)		
PLC I/F	Ethernet		
Port no.	102		
PLC sta. no.	1	1~99	
Local TSAP	1000		Must be greater than 1000
Remote TSAP	2100		Range:2000~2700

★ For TSAP settings please refer to PLC Setting below.

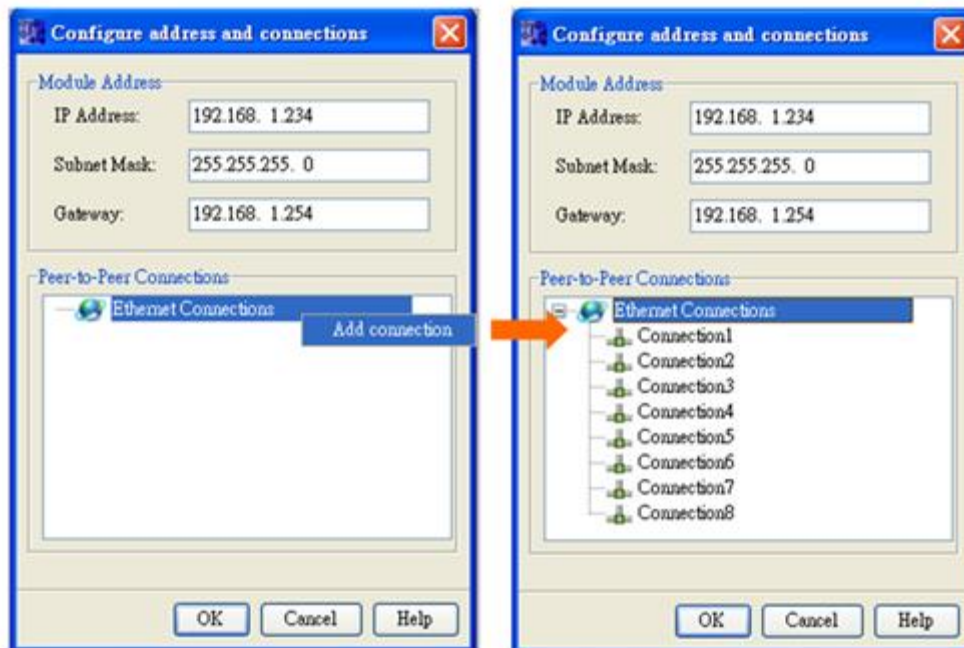
PLC Setting:

Siemens LOGO! multi connection setting requires LOGO! Soft Comfort software to set PLC to identify the connected devices. The following introduces LOGO! Soft Comfort settings.

Step 1. Tools -> Ethernet Connections

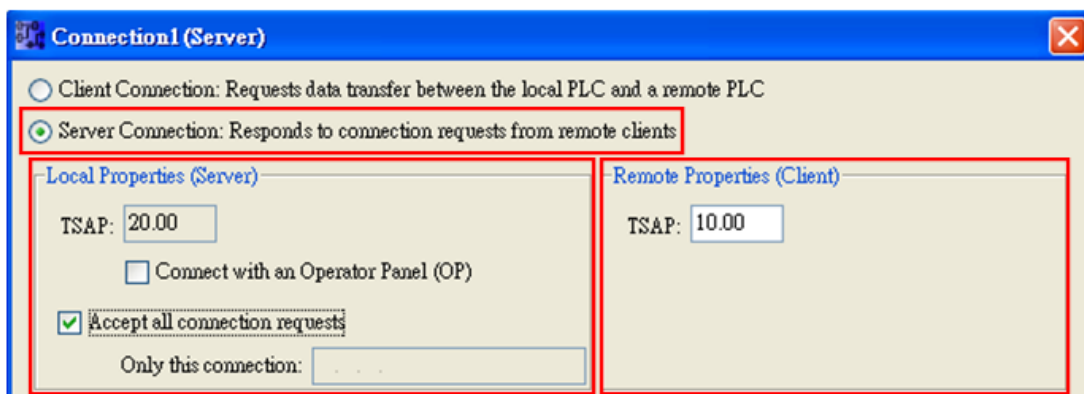


Step 2. Right click on "Ethernet Connections" and click "Add connections" to add a connection, up to eight connections are allowed.

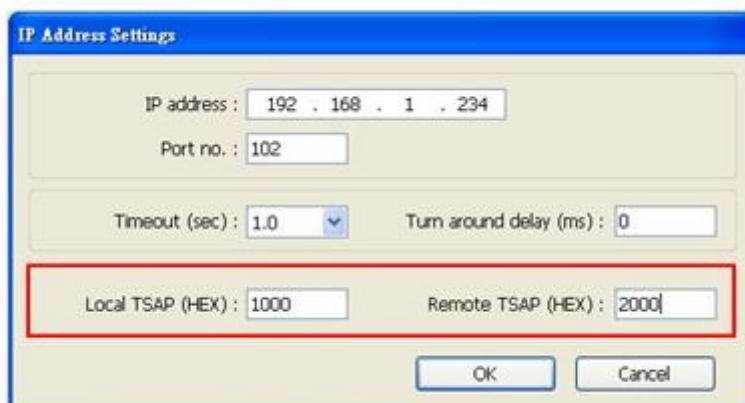


Step 3. Setting Server

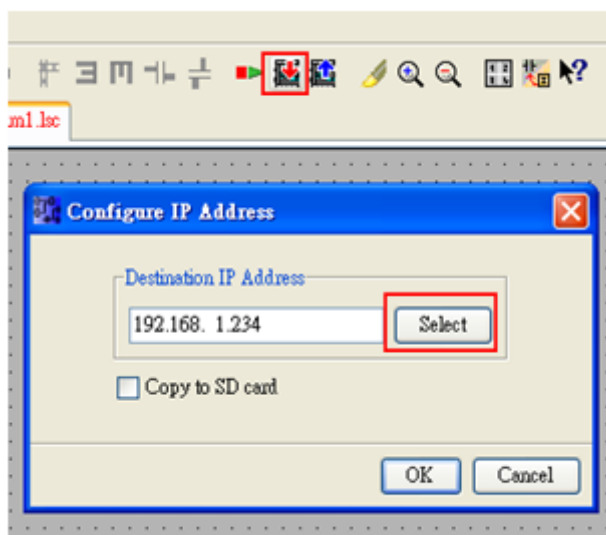
- I. Double click on Connection1, then select "Server Connection".
- II. Local TSAP is system default and can't be modified. Tick "Accept all connection requests" to connect to any IP.
- III. Remote TSAP set to "10.00".
- IV. Connection 2~8 can all be set as above.



Note: The value of Local TSAP and Remote TSAP must be set oppositely in EasyBuilder for communication.



Step 4. Complete settings, download connection to Siemens LOGO!



Device Address:

Bit/Word	Device type	Format	Range	Memo
B	I	DD	1~64	Read Only
B	Q	DD	1~64	
B	M	DD	1~112	
B	NI	DDD	1~128	
B	NQ		1~128	
B	V	DDDDo	0~14697	VW_Bit
W	AI	D	1~16	
W	AQ	D	1~16	
W	AM	DD	1~64	
W	NAI		1~64	

Bit/Word	Device type	Format	Range	Memo
W	NAQ		1~32	
W	VW	DDDD	0~1468	See Table 1&2 Address Mapping
DW	VD	DDDD	0~1466	

Table 1 Address Mapping (LOGO! 0BA7)

I	VW	Q	VW	M	VW	AI	VW	AQ	VW	AM	VW
I1	V923.0	Q1	V942.0	M1	V948.0	AI1	VW926	AQ1	VW944	AM1	VW952
I2	V923.1	Q2	V942.1	M2	V948.1	AI2	VW928	AQ2	VW946	AM2	VW954
I3	V923.2	Q3	V942.2	M3	V948.2	AI3	VW930			AM3	VW956
I4	V923.3	Q4	V942.3	M4	V948.3	AI4	VW932			AM4	VW958
I5	V923.4	Q5	V942.4	M5	V948.4	AI5	VW934			AM5	VW960
I6	V923.5	Q6	V942.5	M6	V948.5	AI6	VW936			AM6	VW962
I7	V923.6	Q7	V942.6	M7	V948.6	AI7	VW938			AM7	VW964
I8	V923.7	Q8	V942.7	M8	V948.7	AI8	VW940			AM8	VW966
I9	V924.0	Q9	V943.0	M9	V949.0					AM9	VW968
I10	V924.1	Q10	V943.1	M10	V949.1					AM10	VW970
I11	V924.2	Q11	V943.2	M11	V949.2					AM11	VW972
I12	V924.3	Q12	V943.3	M12	V949.3					AM12	VW974
I13	V924.4	Q13	V943.4	M13	V949.4					AM13	VW976
I14	V924.5	Q14	V943.5	M14	V949.5					AM14	VW978
I15	V924.6	Q15	V943.6	M15	V949.6					AM15	VW980
I16	V924.7	Q16	V943.7	M16	V949.7					AM16	VW982
I17	V925.0			M17	V950.0						
I18	V925.1			M18	V950.1						
I19	V925.2			M19	V950.2						
I20	V925.3			M20	V950.3						
I21	V925.4			M21	V950.4						
I22	V925.5			M22	V950.5						
I23	V925.6			M23	V950.6						
I24	V925.7			M24	V950.7						
				M25	V951.0						
				M26	V951.1						
				M27	V951.2						

Table 2 Address Mapping (LOGO! 0BA8)

Device Type	VM (From)	VM (To)	Range
I	1024	1031	8 Bytes
AI	1032	1063	32 Bytes
Q	1064	1071	8 Bytes
AQ	1072	1103	32 Bytes
M	1104	1117	14 Bytes
AM	1118	1245	128 Bytes
NI	1246	1261	16 Bytes
NAI	1262	1389	128 Bytes
NQ	1390	1405	16 Bytes
NAQ	1406	1469	64 Bytes

Wiring Diagram:

Ethernet cable:



Siemens S7-1200 (symbolic addressing)

(Ethernet)

Supported Series: Siemens S7-1200 series Ethernet.

Website: <http://www.siemens.com/entry/cc/en/>

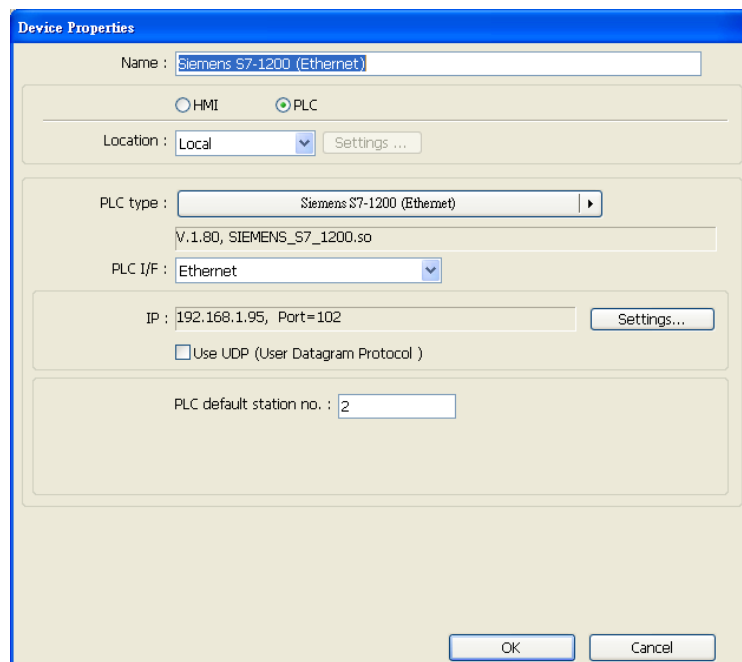
HMI Setting:

Parameters	Recommended	Options	Notes
PLC type	Siemens S7-1200 (symbolic addressing) (Ethernet)		
PLC I/F	Ethernet		
Port no.	102		
PLC sta. no.	2		
Rack	0		
CPU slot	1		

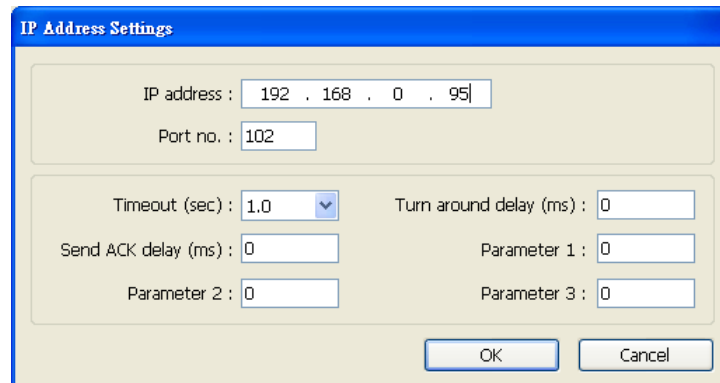
On-line simulator	Yes	Multi-HMI connect	Yes (Max:3 HMI)
--------------------------	-----	--------------------------	-----------------

PLC Setting:

1. In S7-1200 program software create PLC program and tag and then download to PLC.
2. Select Go offline, EasyBuilder will connect to PLC and get tag data. In PLC type select "SIEMENS S7-1200 (Ethernet)".



- Click “Settings...”, input PLC IP address.

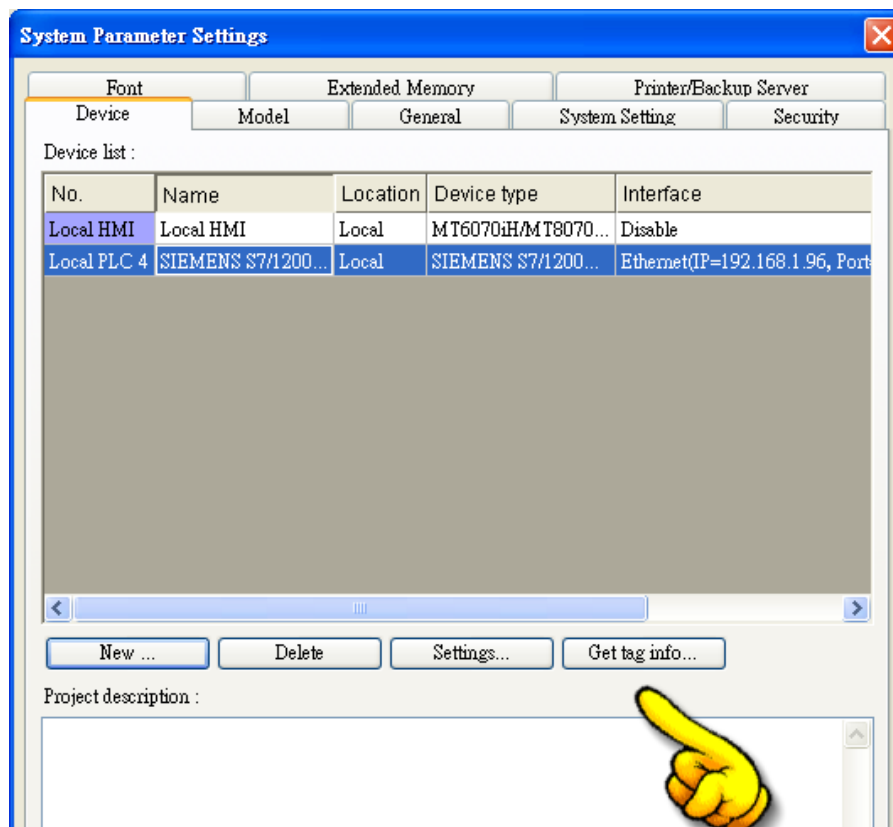


The IP Address Settings dialog box contains the following fields:

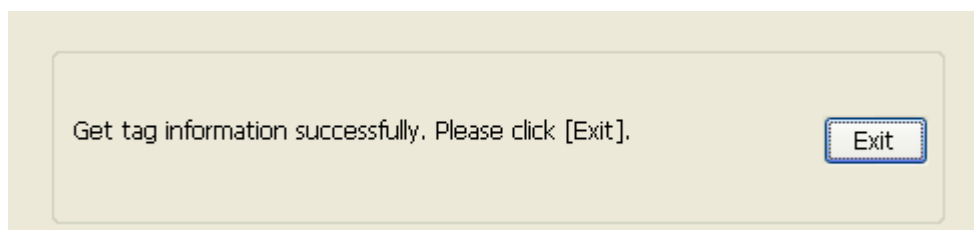
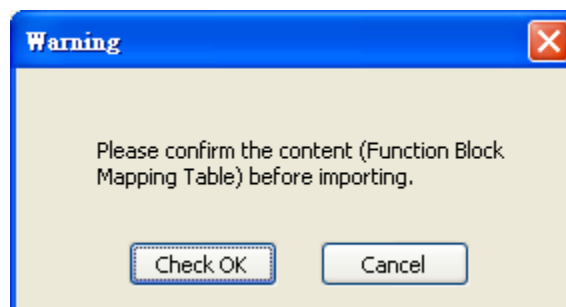
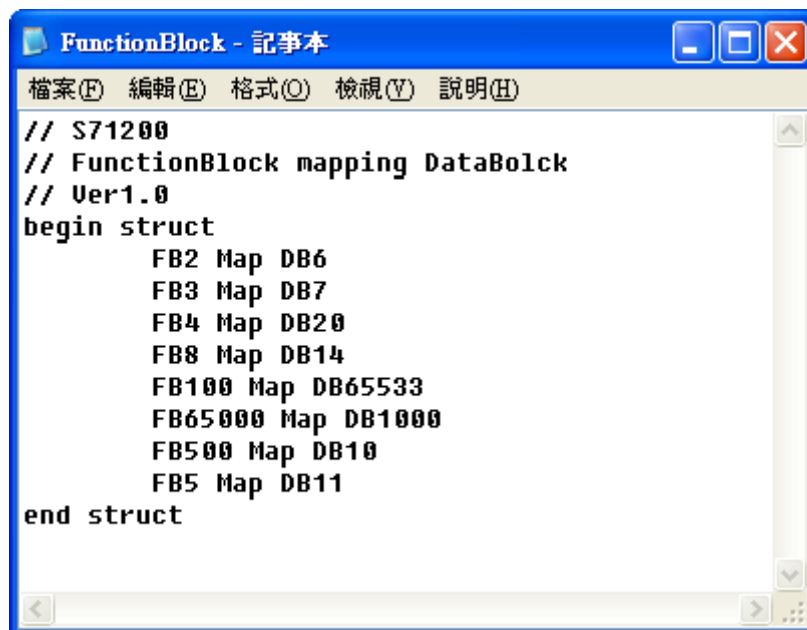
- IP address : 192 . 168 . 0 . 95
- Port no. : 102
- Timeout (sec) : 1.0 (dropdown menu)
- Turn around delay (ms) : 0
- Send ACK delay (ms) : 0
- Parameter 1 : 0
- Parameter 2 : 0
- Parameter 3 : 0

Buttons: OK, Cancel

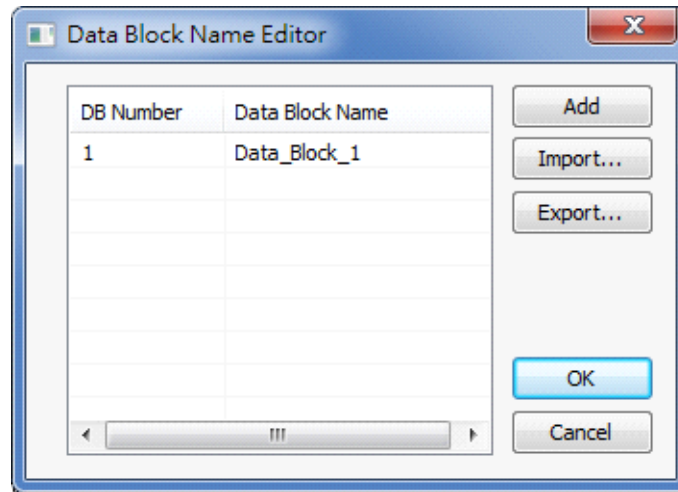
- Check the PLC that is not connected to any PC. Click “Get tag info...”.
- Supported by firmware V3.X and previous versions. For V4.0 or later, please see **How to Connect With S7-1200 Firmware V4.0**



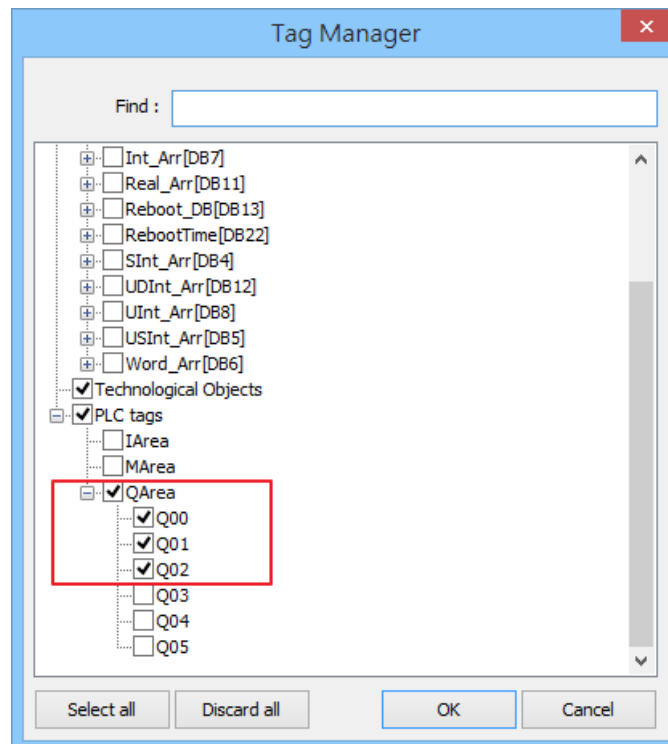
6. If the software used is a version later than TIA Portal V11 , SP2, a dialog of FunctionBlock directory will be shown, users have to define the mapping from FB to DB in this directory then click “Check OK” . The tag information will be gained and a successful message is shown.



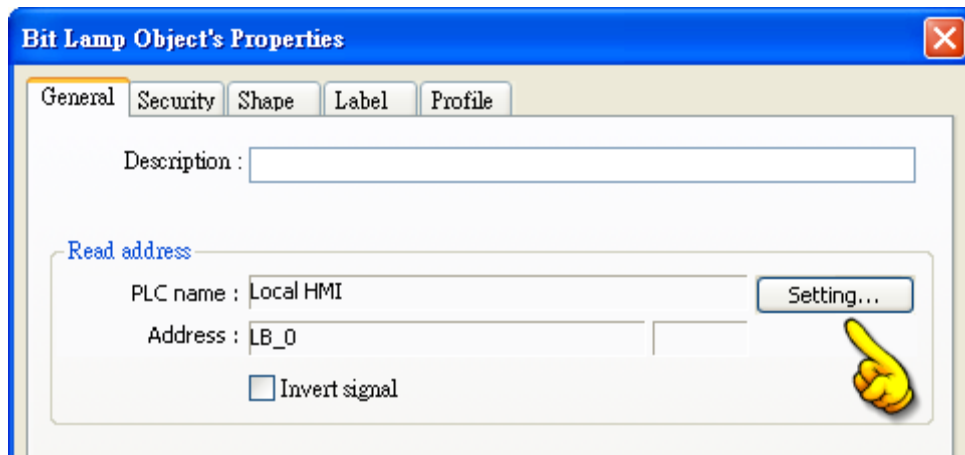
7. When opening an existing project and get the tag information again, if the PLC software used is TIA Portal V12 and later versions, the DB name must be entered again in order to compile the project.



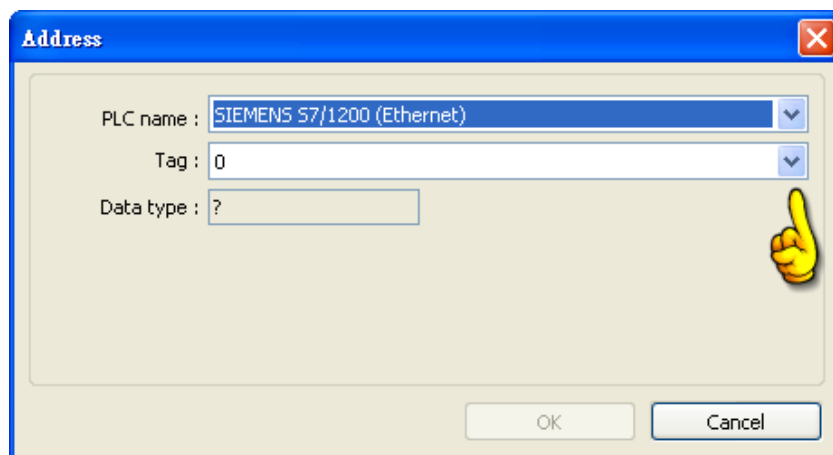
8. Added Tag Manager that allows selecting the Siemens S7-1200 PLC tags to be imported.



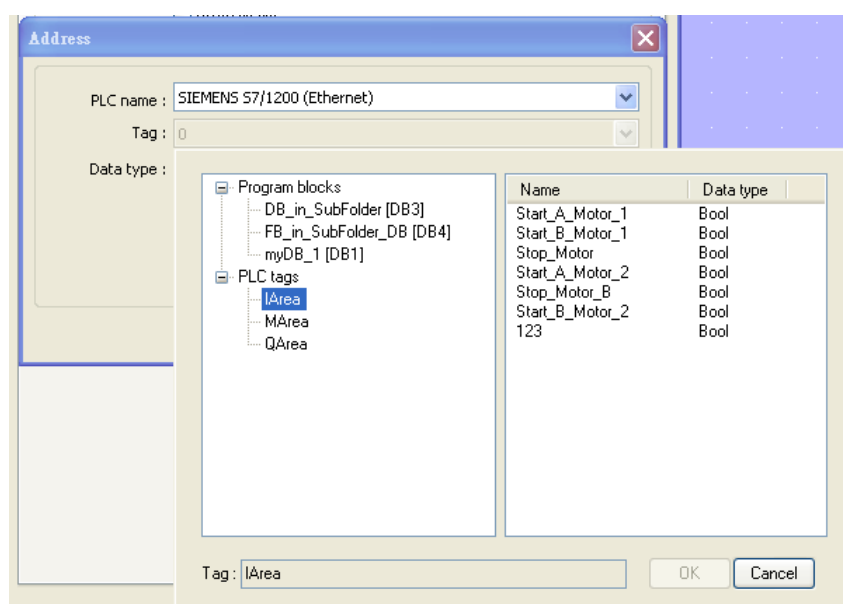
9. Create an object and click read address “Setting...”



10. In PLC name select S7-1200 then click Tag.



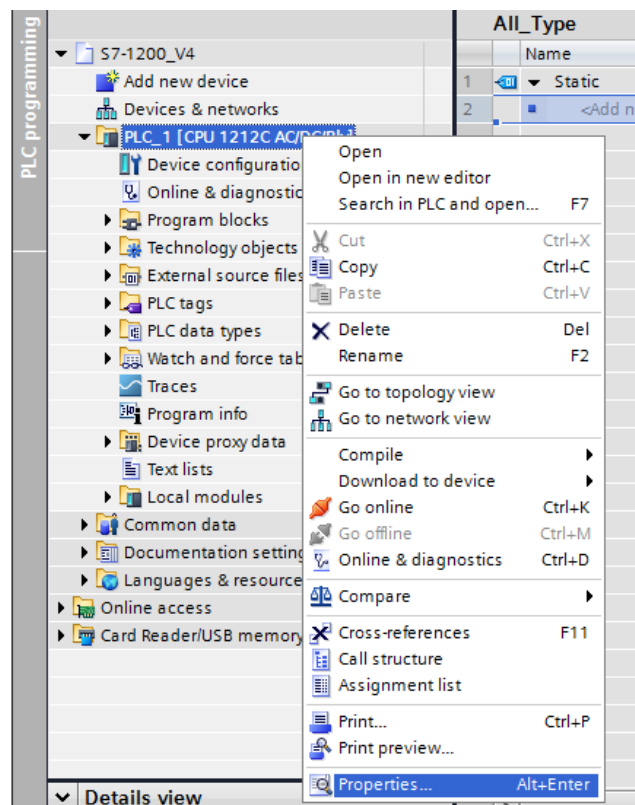
11. Select PLC tag.



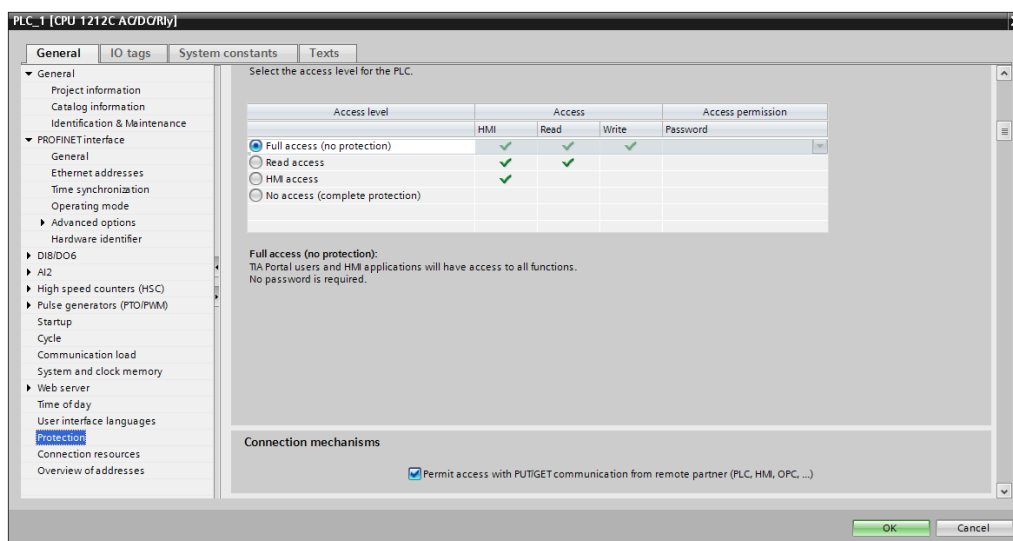
How to Connect With S7-1200 Firmware V4.0

There are certain restrictions in S7-1200 firmware V4.0, therefore, to avoid communication errors, please follow the steps to set up. (EasyBuilder8000 does not support Siemens S7-1200 firmware V4.0 and later versions).

Right click on the PLC program, and then click **[Properties]**.



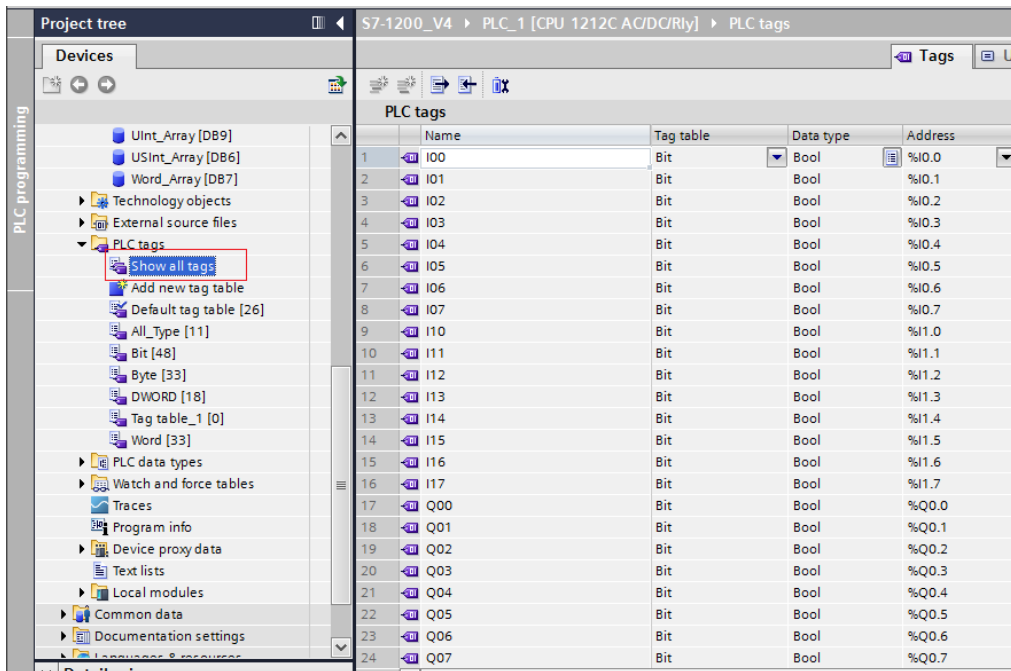
Select **[Protection]**, and then select **[Permit access with PUT/GET communication from remote partner (PLC,HMI,OPC,...)]**.



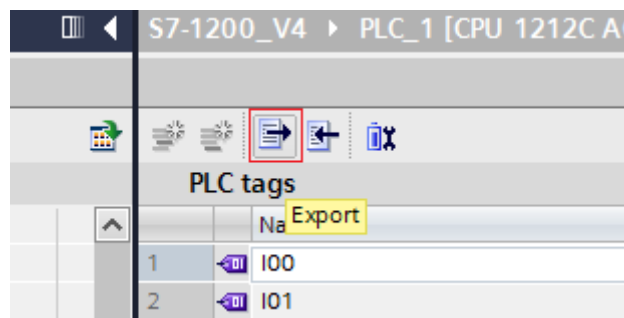
The following part introduces how to export S7-1200 PLC Tags and Program Blocks.

Exporting PLC Tags (I,Q,M tags)

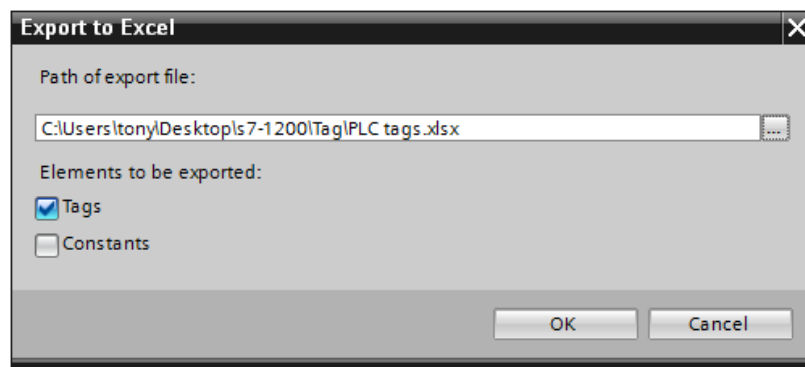
1. Under **[PLC tags]** select **[Show all tags]**.



2. Click **[Export]** to export the tags.

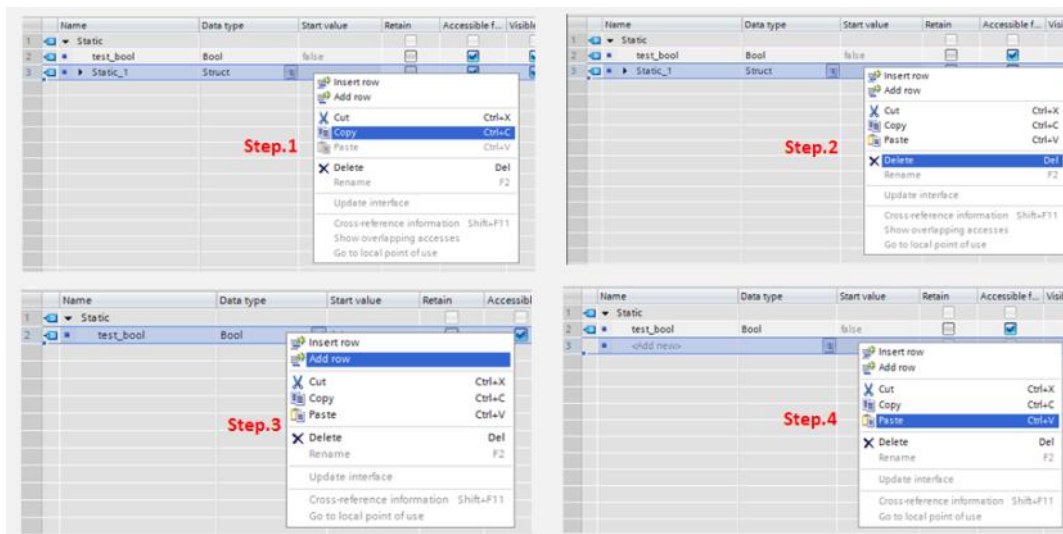


3. Browse for the directory to save the exported file and then click **[OK]**.

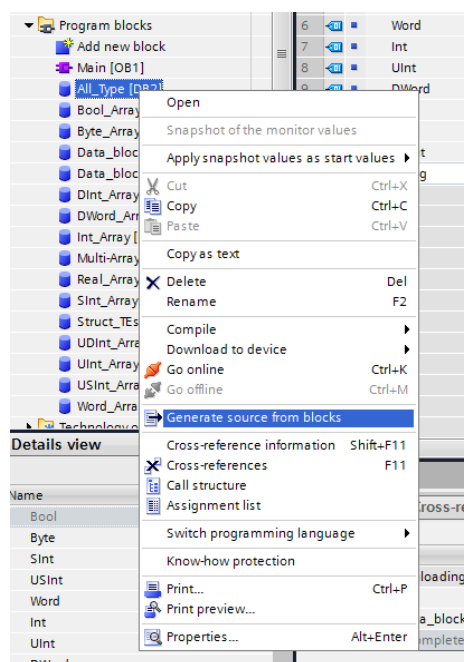


Exporting Program Blocks(DB)

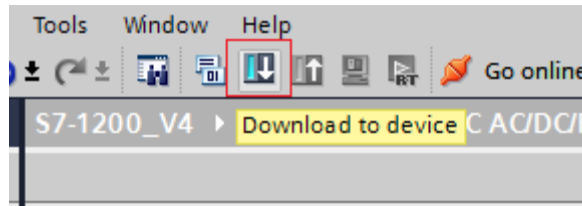
1. When the database contains Struct data type, please note the following restrictions.
 - Please at least add one data member that doesn't belong to Struct data type into DB, otherwise, the data cannot be imported to EasyBuilder.
 - Multidimensional Arrays and Multilayer Structs are not supported.
 - After building DB, please do the following actions for Struct address:
 - (1) Copy the complete Struct data.
 - (2) Delete data.
 - (3) Add a new row.
 - (4) Paste data.



2. Right click on DB, click **[Generate source from blocks]**, and then enter the file name to save.

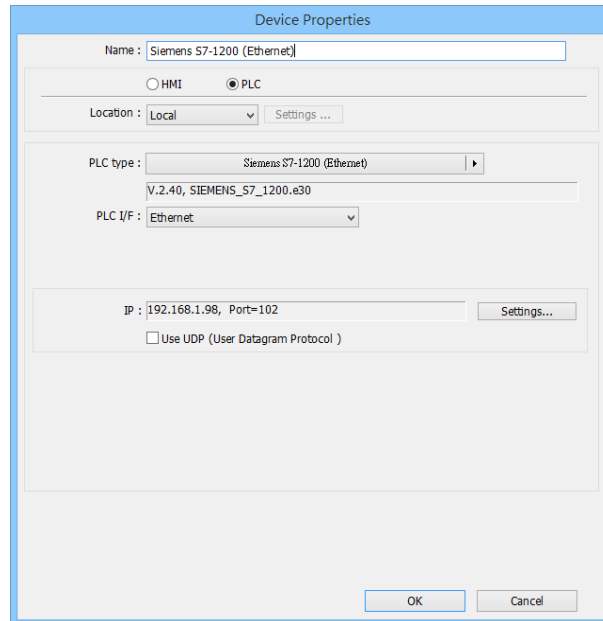


After building and importing PLC Tags and Program Blocks, click **[Download to device]**.

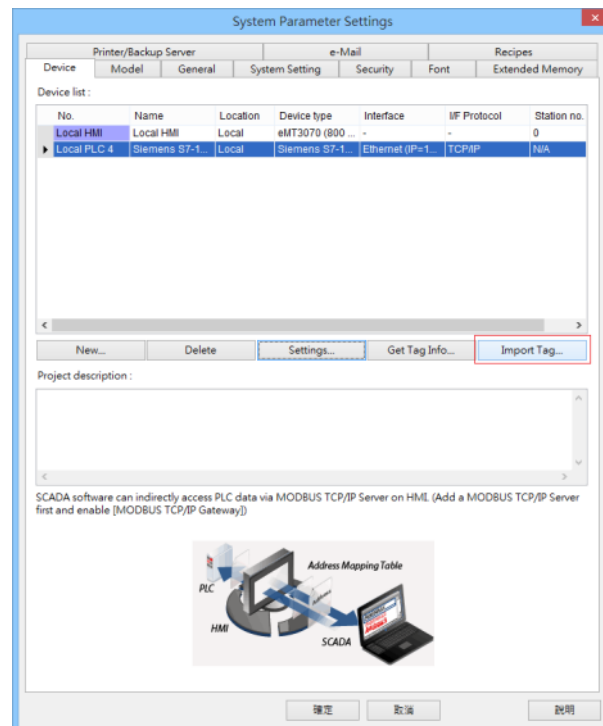


Importing PLC Tags and Program Blocks(DB)

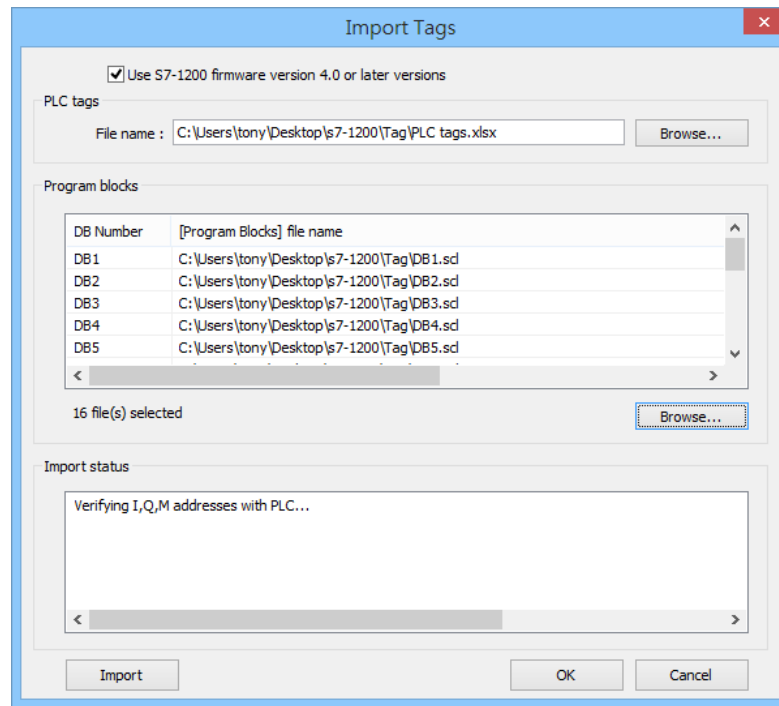
1. Launch EasyBuilder and set the IP address.



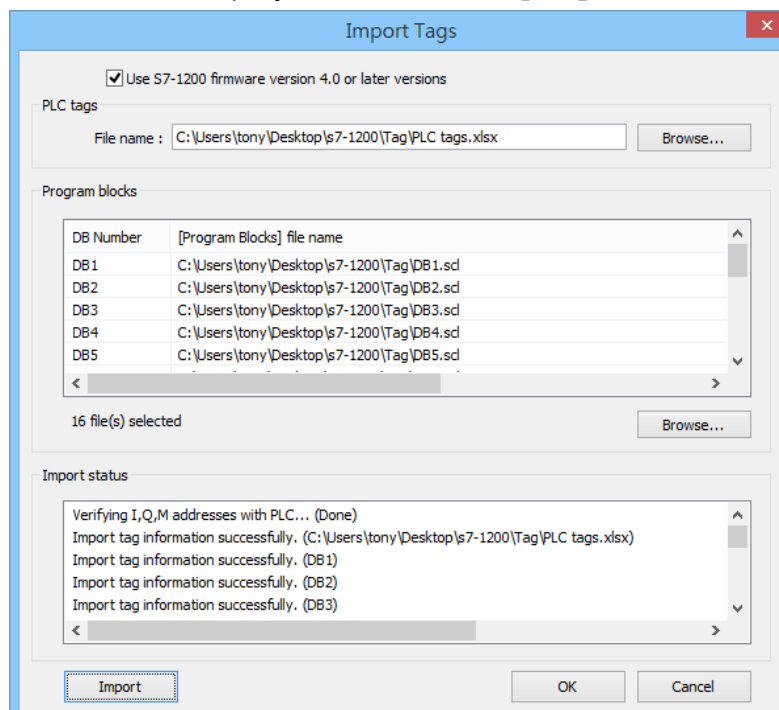
2. Click **[Import Tag...]**.



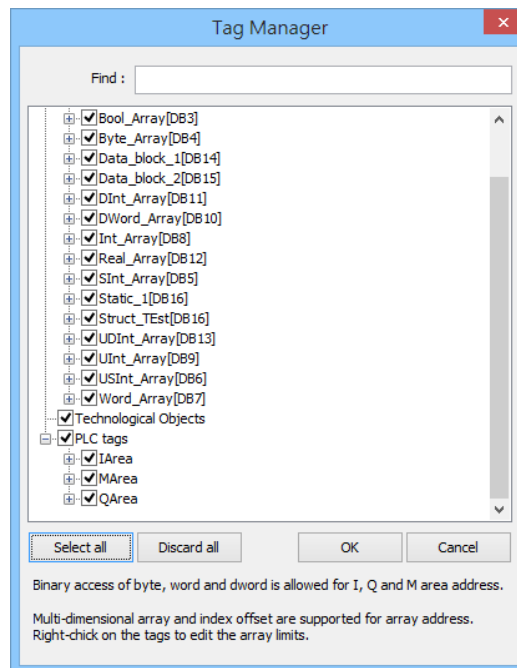
3. Select the PLC Tags and Program Blocks to be imported. Please remember to change DB number, and select **[Use S7-1200 firmware version 4.0 or later versions]**. Click **[Import]** to import the files. The I, Q, and M addresses will be checked, if an error occurs, the communication will fail. If this happens, please check your communication environment, and try to import again.



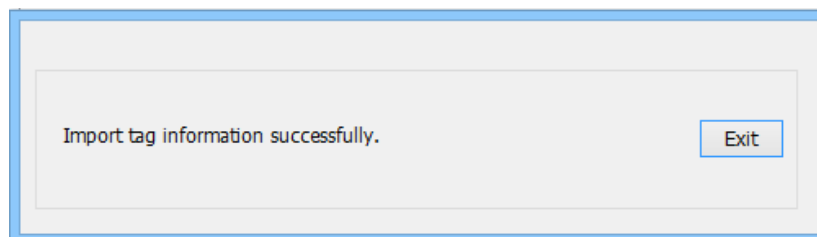
4. The "Import status" field will display the result, click **[OK]**.



5. Select the tags to be imported and then click **[OK]**.



6. The following message is displayed when the import has succeeded.



Support Device Type:

S7-1200 data type	EasyBuilder data format	Memo
Bool	bit	
Byte	16-bit BCD, Hex, Binary, Unsigned	8-bit
SInt	16-bit BCD, Hex, Binary, Signed	8-bit
USInt	16-bit BCD, Hex, Binary, Unsigned	8-bit
Word	16-bit BCD, Hex, Binary, Unsigned	16-bit
Int	16-bit BCD, Hex, Binary, Signed	16-bit
UInt	16-bit BCD, Hex, Binary, Unsigned	16-bit
DWord	32-bit BCD, Hex, Binary, Unsigned	32-bit
DInt	32-bit BCD, Hex, Binary, Signed	32-bit
Real	32-bit Float	32-bit
UDInt	32-bit BCD, Hex, Binary, Unsigned	32-bit
Char	16-bit BCD, Hex, Binary, Unsigned	USInt
CREF		Struct
Date	16-bit BCD, Hex, Binary, Unsigned	UInt
DTL		
ErrorStruct		
IEC_COUNTER		
IEC_DCOUNTER		
IEC_SCOUNTER		
IEC_TIMER		
IEC_UCOUNTER		
IEC_UDCOUNTER		
IEC_USCOUNTER		
NREF		
Time	32-bit BCD, Hex, Binary, Unsigned	DWord
Time_Of_Day	32-bit BCD, Hex, Binary, Unsigned	DWord

S7-1200 data type	EasyBuilder data format	Memo
Array		Bool, Byte, SINT, USInt, Word, Int, UInt, DWord, Dint, Real, UDInt
Struct		Bool, Byte, SINT, USInt, Word, Int, UInt, DWord, Dint, Real, UDInt

Wiring Diagram:

Ethernet cable:



Siemens S7-1200/S7-1500 (absolute addressing) (Ethernet)

Supported Series: Siemens S7-1500/1200 series Ethernet.

Website: <http://www.siemens.com/entry/cc/en/>

HMI Setting:

Parameters	Recommended	Options	Notes
PLC type	Siemens S7-1200/S7-1500 (absolute addressing) (Ethernet)		
PLC I/F	Ethernet		
Port no.	102		
PLC sta. no.	2		
Rack	0		
CPU slot	1		

On-line simulator	Yes	Multi-HMI connect	Yes (Max:3 HMI)
--------------------------	-----	--------------------------	-----------------

Support Device Type:

S7-1200 data type	EasyBuilder data format	Memo
Bool	bit	
Byte	16-bit BCD, Hex, Binary, Unsigned	8-bit
SInt	16-bit BCD, Hex, Binary, Signed	8-bit
USInt	16-bit BCD, Hex, Binary, Unsigned	8-bit
Word	16-bit BCD, Hex, Binary, Unsigned	16-bit
Int	16-bit BCD, Hex, Binary, Signed	16-bit
UInt	16-bit BCD, Hex, Binary, Unsigned	16-bit
DWord	32-bit BCD, Hex, Binary, Unsigned	32-bit
DInt	32-bit BCD, Hex, Binary, Signed	32-bit
Real	32-bit Float	32-bit
UDInt	32-bit BCD, Hex, Binary, Unsigned	32-bit
Array		

Device Address:

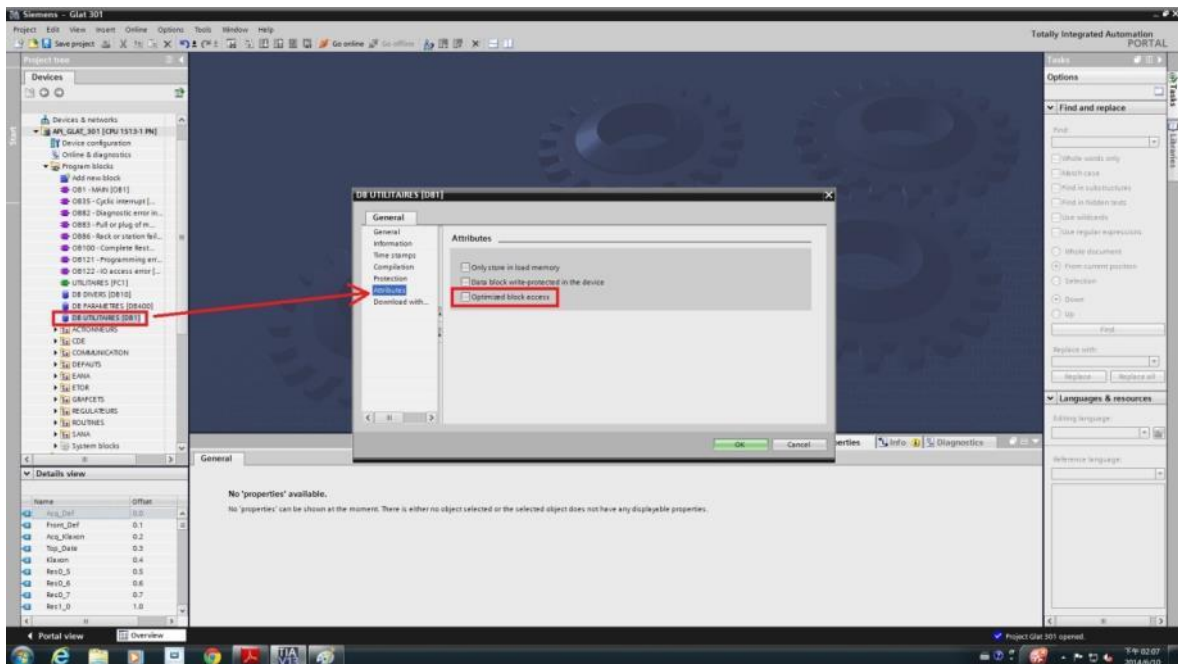
Bit/Word	Device type	Format	Range	Memo
B	I	DDDDDo	0 ~ 655357	Input (I)
B	Q	DDDDDo	0 ~ 655357	Output (O)
B	M	DDDDDo	0 ~ 655357	Bit Memory
B	DBnBit	FFFFFFDDDDo	0 ~ 655359997	
B	DBxBit	FFFFFFDDDDDo	0 ~ 10700655327	
B	DB1Bit-DB99Bit	DDDDDo	0 ~ 655327	Data Register Bit
BYTE	IB	DDDDD	0 ~ 65535	Input (I)
W	IW	DDDDD	0 ~ 65533	Input (I)
DW	ID	DDDDD	0 ~ 65532	Input (I)
BYTE	QB	DDDDD	0 ~ 65535	Output (O)
W	QW	DDDDD	0 ~ 65533	Output (O)
DW	QD	DDDDD	0 ~ 65532	Output (O)
BYTE	MB	DDDDD	0 ~ 65535	Bit Memory
W	MW	DDDDD	0 ~ 65533	Bit Memory
DW	MD	DDDDD	0 ~ 65532	Bit Memory
BYTE	DBBn	FFFFFFDDDD	0 ~ 655359999	Data Register
BYTE	DBBx	FFFFFFDDDD	0 ~ 1070065532	Data Register
W	DBn	FFFFFFDDDD	0 ~ 655359999	Data Register
W	DBx	FFFFFFDDDD	0 ~ 1070065532	Data Register
DW	DBDn	FFFFFFDDDD	0 ~ 655359999	Data Register
DW	DBDx	FFFFFFDDDD	0 ~ 1070065532	Data Register
W	DBn_String	FFFFFFDDDD	0 ~ 655359999	Char Array
W	DBx_String	FFFFFFDDDD	0 ~ 1070065532	Char Array
W	DBn_String1	FFFFFFDDDD	0 ~ 655359999	String
W	DBx_String1	FFFFFFDDDD	0 ~ 1070065532	String
DW	DBDn_String	FFFFFFDDDD	0 ~ 655359999	Char Array
DW	DBDx_String	FFFFFFDDDD	0 ~ 1070065532	Char Array
W	DB1 ~ DB99	DDDDD	0 ~ 65532	Data Register
DW	S5TIME_10Ms	FFFFFFDDDD	0 ~ 655359999	
DW	S5TIME_100Ms	FFFFFFDDDD	0 ~ 655359999	
DW	S5TIME_1S	FFFFFFDDDD	0 ~ 655359999	
DW	S5TIME_10S	FFFFFFDDDD	0 ~ 655359999	

- Double word and floating point value must use DBDn device type.

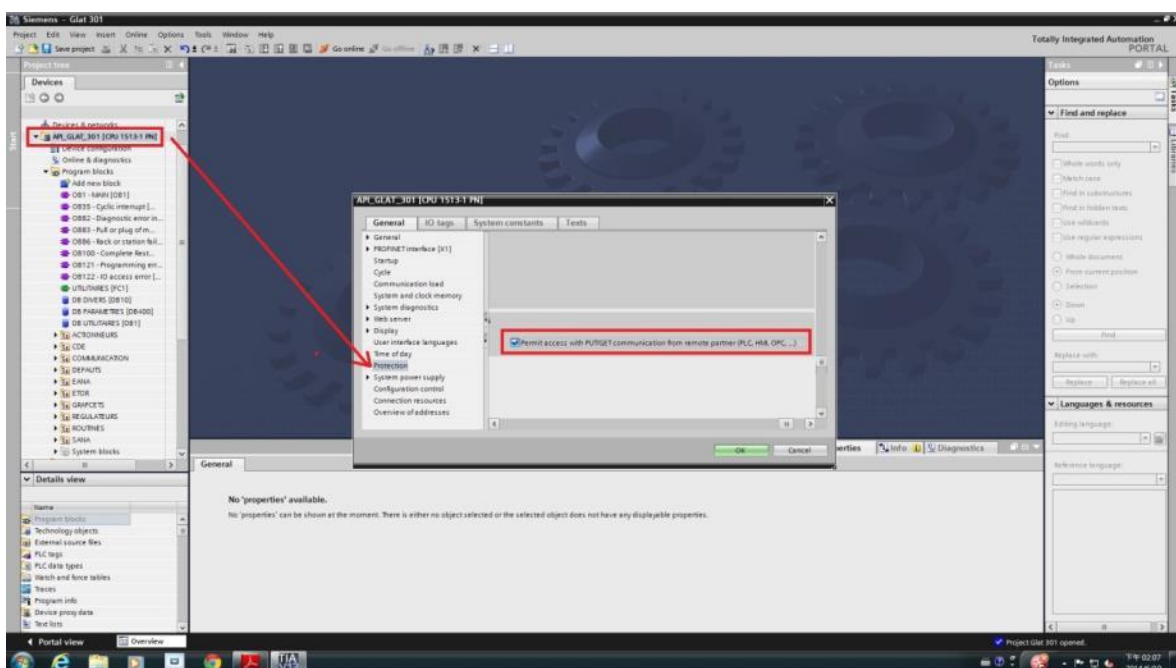
PLC Setting:

Note: Please follow the settings below, or the communication may fail.

1. Do not check [DB UTILITAIRES] -> [Attributes] -> [Optimized block access]



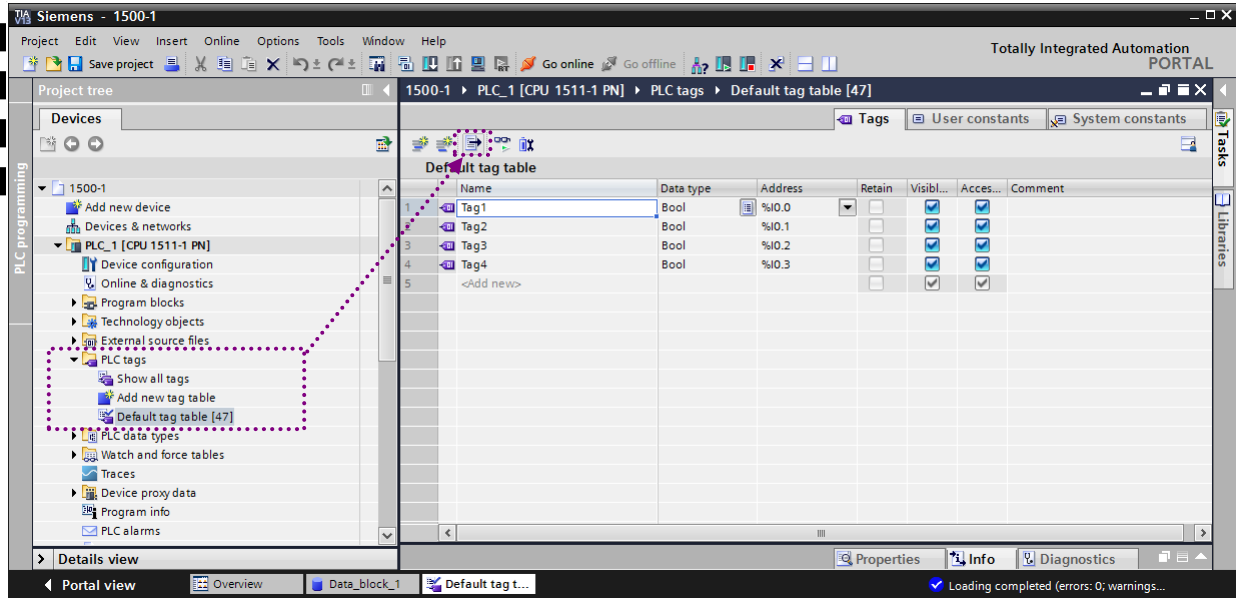
2. Check [General] -> [Protection] -> [Permit access with PUT/GET communication from remote partner]



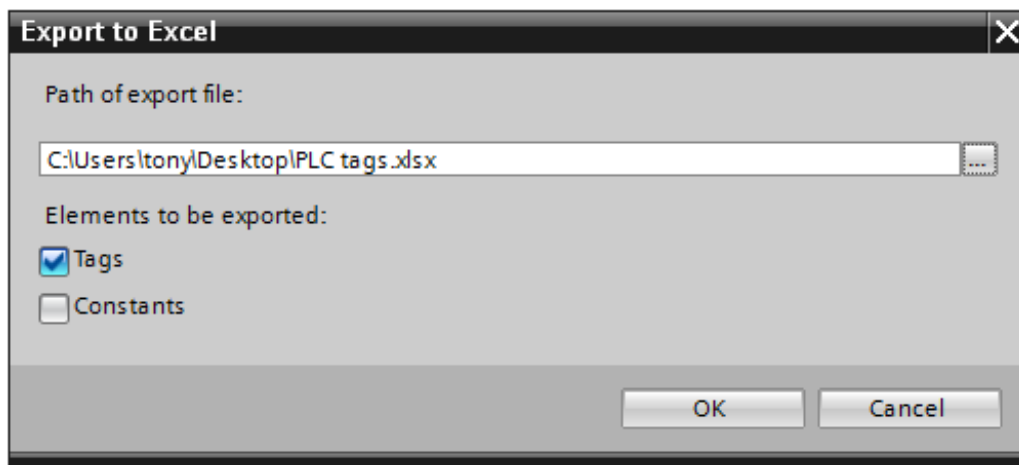
How to import address tags using TIA portal?

1. Exporting PLC Tags (.xlsx file format).

1.1 Under [PLC tags] create the address tags and then click the Export icon.

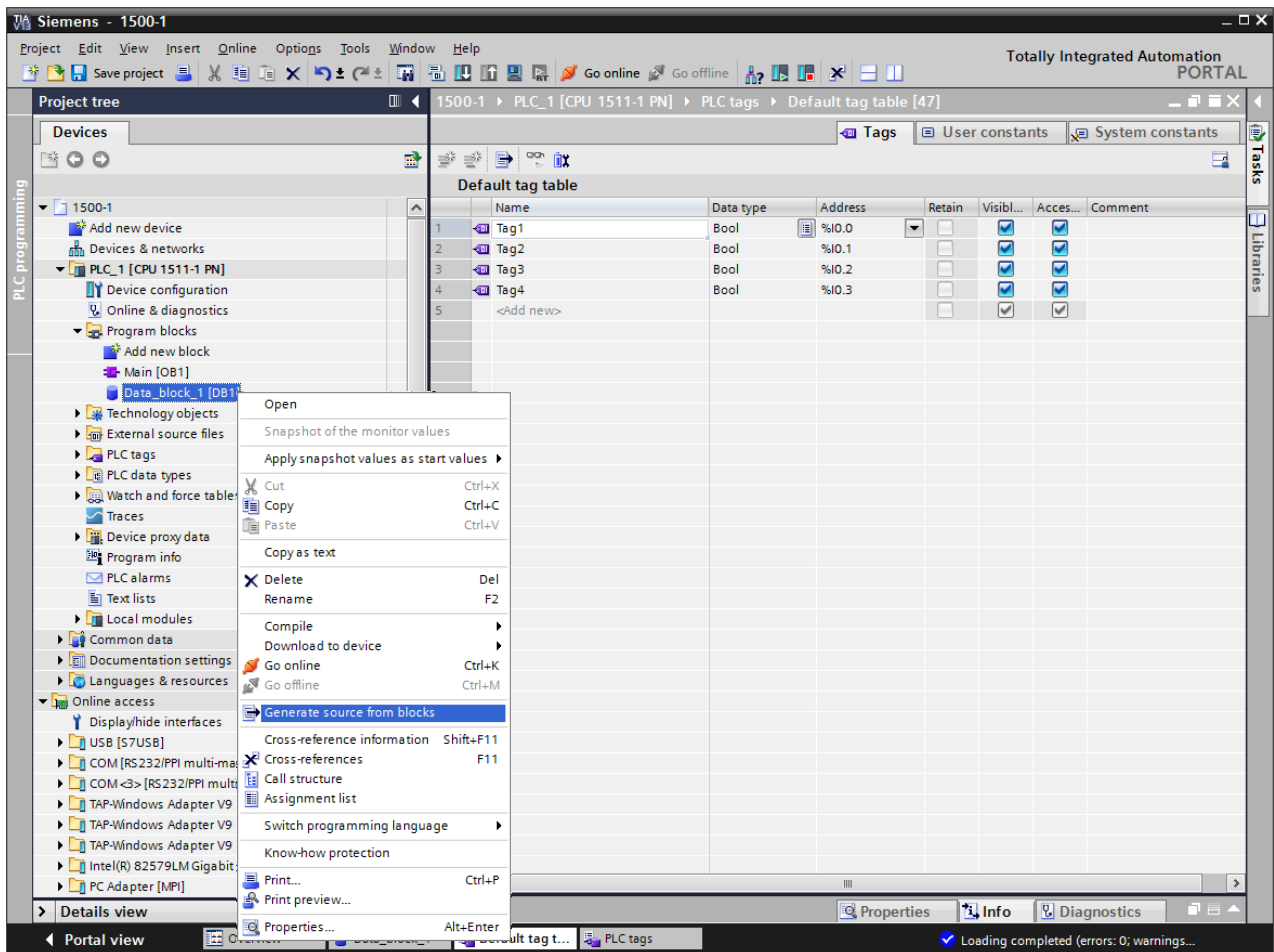


1.2 Designate the directory to save the file and click OK button.

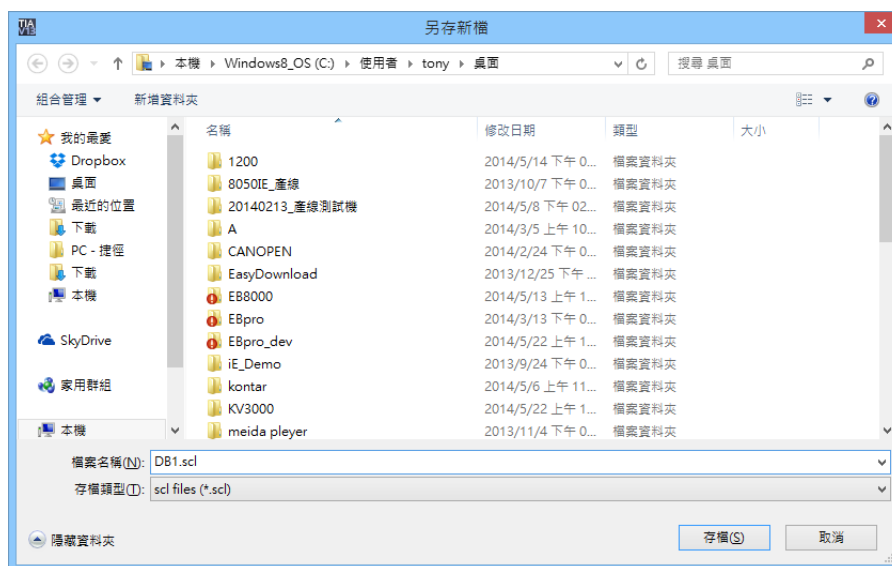


2. Exporting Program Blocks (.scl file format).

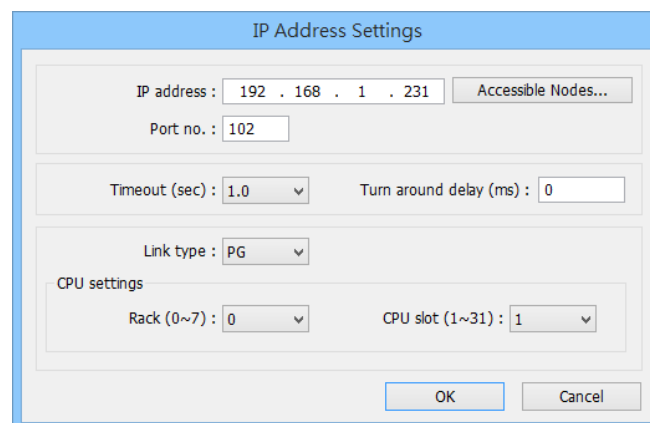
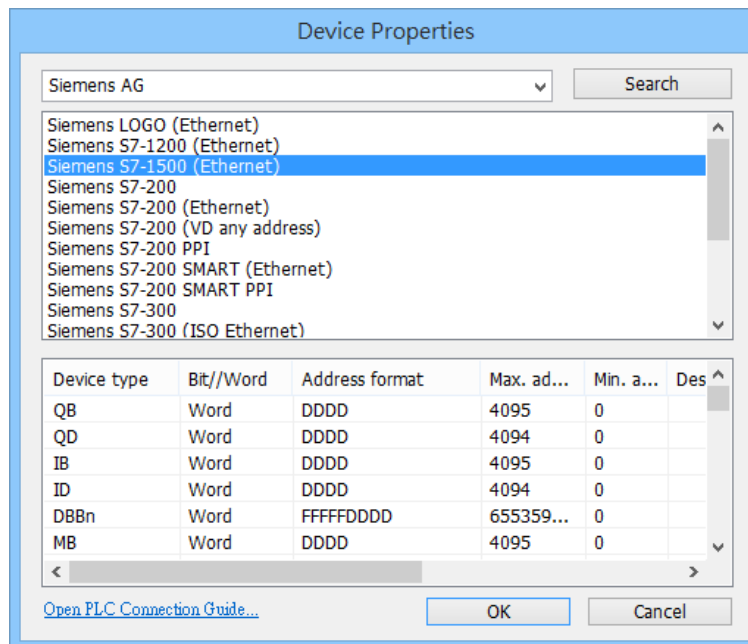
2.1 Under [Program blocks] create “Data_block_1 [DB1]” as shown in the following figure. Click the right mouse button on [DB1] and then click [Generate source from blocks].



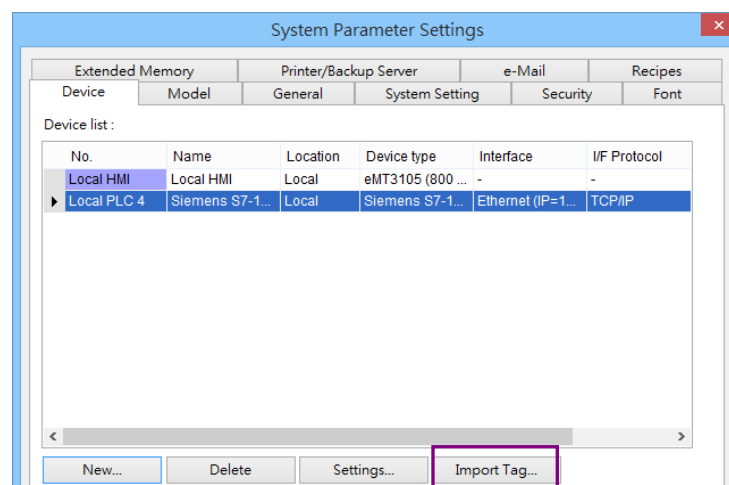
2.2 Designate the directory to save the file.



3. In EasyBuilder click [New PLC...], select *Siemens S7-1500 (Ethernet)* PLC type, and then click [Settings...] to set the parameters.

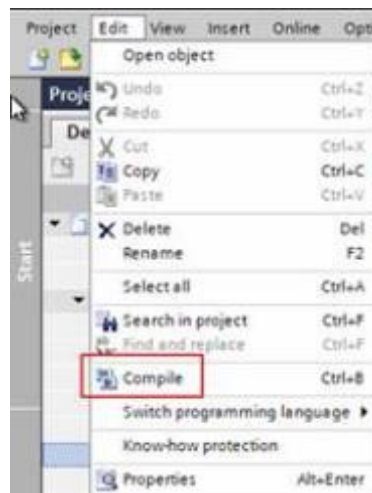
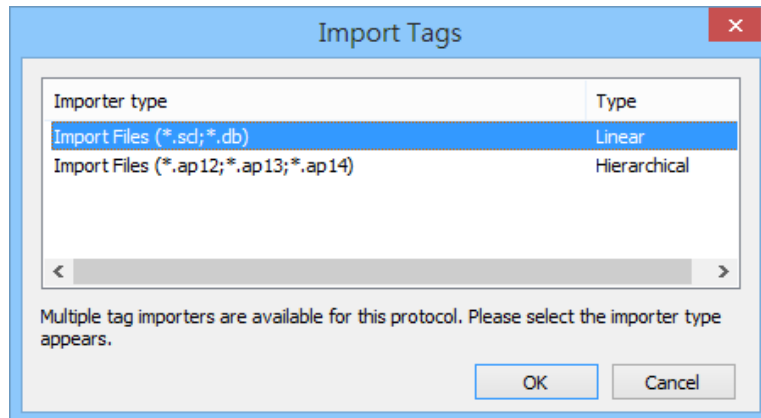


4. Click [Import Tag...] button.

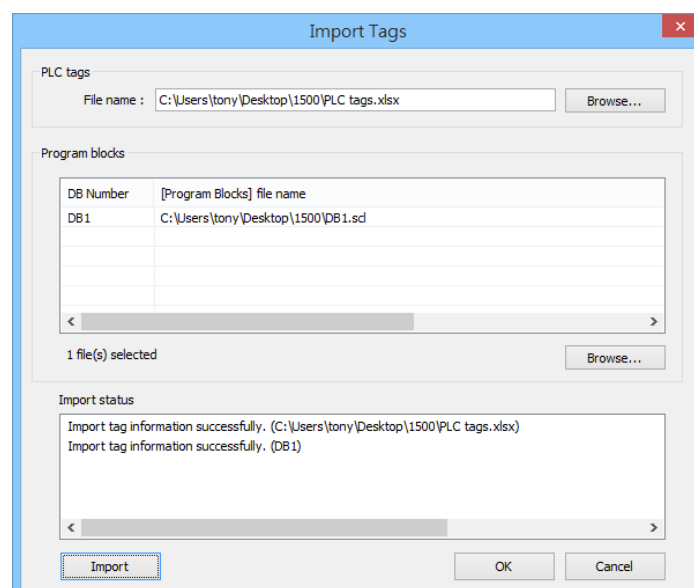


5. Select file type (*.sd; *.db) or select TIA file (*.ap12; *.ap13; *.ap14) for import.

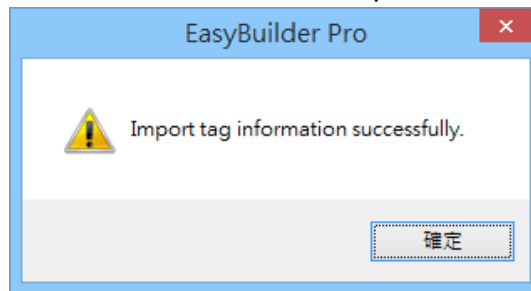
Compiling the TIA file by using TIA software before import is necessary to avoid importing incomplete data.



6. Select the PLC Tags and Program Blocks to be imported, click [Import] button, and then click [OK] to leave when the tags are imported successfully.



7. The following message window is shown if the import has succeeded.



Wiring Diagram:

Ethernet cable:



Siemens S7-200

Supported Series: Siemens S7-200 series PLC
(CPU212/214/215/216/221/222/224/226/226XM)

Website: <http://www.siemens.com/entry/cc/en/>

HMI Setting:

Parameters	Recommen	Options	Notes
PLC type	SIEMENS S7-200		
PLC I/F	RS485 2w	RS485 2w	
Baud rate	9600	9600, 19200, 187.5K	The HMI which has a sticker "MPI187.5" on the rear cover supports 187.5K
Data bits	8	7,8	
Parity	Even	Even, Odd, None	
Stop bits	1	1, 2	
PLC sta. no.	2	1 ~ 126	
Turn around delay	5		
Send ACK delay(ms)	30		

Online simulator	YES	Extend address mode	NO
Broadcast command	NO		

PLC Setting:

Communication	Set station number to 2
---------------	-------------------------

Device Address:

Bit/Word	Device type	Format	Range	Memo
B	I	DDDDo	0 ~ 40957	Input (I)
B	Q	DDDDo	0 ~ 40957	Output (O)
B	M	DDDDo	0 ~ 40957	Bit Memory
B	VW_Bit	DDDDDo	0 ~ 102397	V Memory Bit Address
B	S	DDDDo	0 ~ 40957	SCR
B	SM	DDDDo	0 ~ 40957	Special Memory
B	T_Bit	DDD	0 ~ 255	Timer
B	C_Bit	DDD	0 ~ 255	Counter

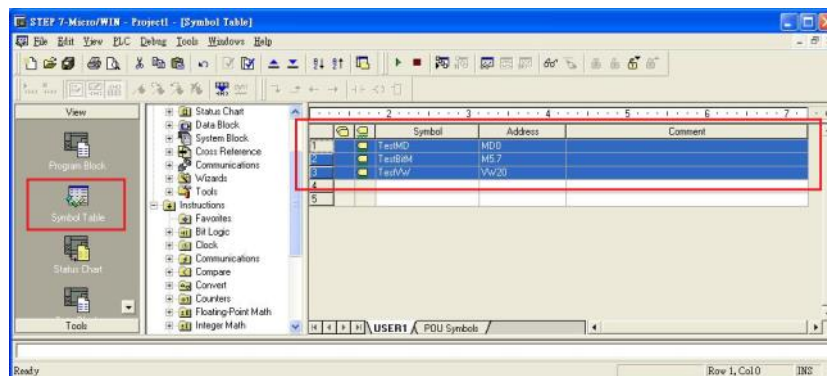
Bit/Word	Device type	Format	Range	Memo
Byte	VB	DDDDD	0 ~ 10239	V Memory
W	VW	DDDDD	0 ~ 10239	V Memory
W	VW_Odd	DDDDD	0 ~ 10239	V Memory
DW	VD	DDDDD	0 ~ 10239	V Memory Double Word
DW	VD_Odd	DDDDD	0 ~ 10239	V Memory Double Word
W	VW_String	DDDDD	0 ~ 10239	String
W	VW_String_Odd	DDDDD	0 ~ 10239	String
DW	VD_String	DDDDD	0 ~ 10239	String
DW	VD_String_Odd	DDDDD	0 ~ 10239	String
Byte	MB	DDDDD	0 ~ 10239	Byte Memory
W	MW	DDDDD	0 ~ 10239	Word Memory
W	MW_Odd	DDDDD	0 ~ 10239	Word Memory
DW	MD	DDDDD	0 ~ 10239	Word Memory
Byte	SB	DDDDD	0 ~ 10239	SCR
W	SW	DDDDD	0 ~ 10239	SCR
DW	SD	DDDDD	0 ~ 10239	SCR
Byte	SMB	DDDDD	0 ~ 10239	Special Memory
W	SMW	DDDDD	0 ~ 10239	Special Memory
DW	SMD	DDDDD	0 ~ 10239	Special Memory
W	T	DDD	0 ~ 255	Timer
W	C	DDD	0 ~ 255	Counter

- Double word and floating point value must use VD device type.

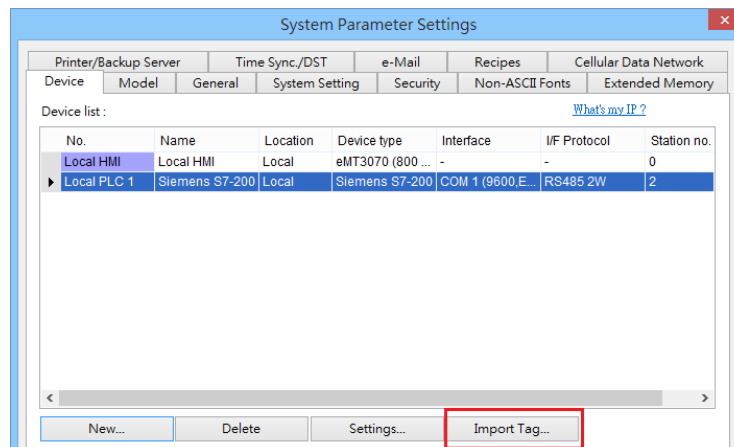
How to Import Tag:

The tags created in the Symbol Table in Step7-MicroWIN software can be imported to EasyBuilder.

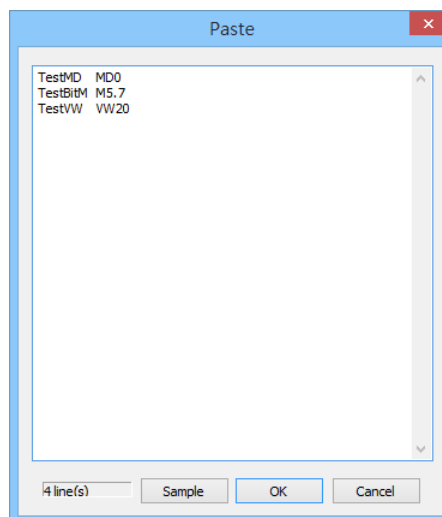
1. In **Symbol Table** create the tags. Select all the tags and click the right mouse button then **copy** the tags.



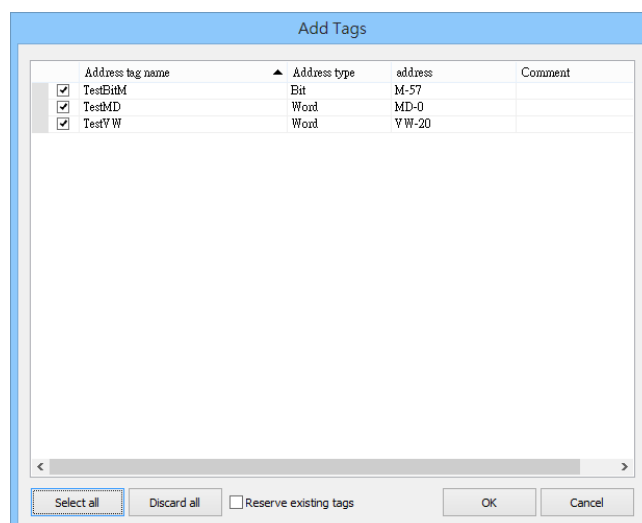
2. Launch EasyBuilder, add the driver in the device list in **System Parameter Settings**, and then click **Import Tag** button.



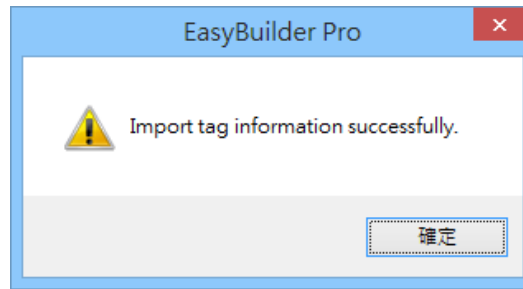
3. **Paste** the tags copied in step 1 and then click **OK**.



4. Select all the tags and then click **OK**.



5. If succeeded, the following message window shows.



Wiring Diagram:

Diagram 1

cMT Series

cMT3151

eMT Series

eMT3070 / eMT3105 / eMT3120 / eMT3150

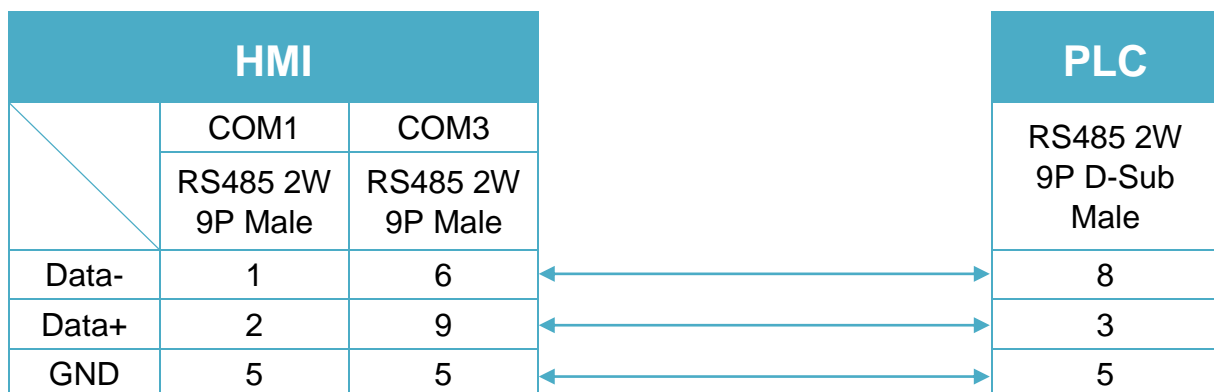


Diagram 2

cMT Series

cMT-SVR

mTV

mTV

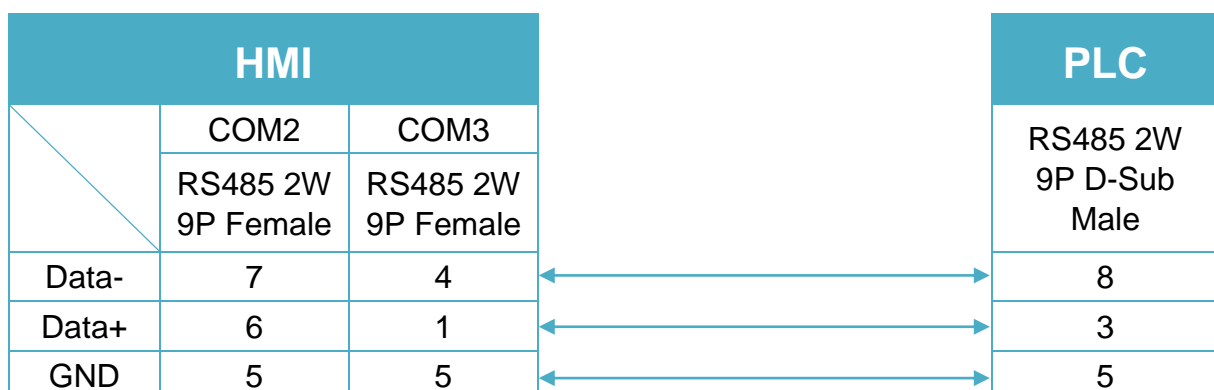


Diagram 3

MT-iE *MT8070iE / MT6070iE / MT8100iE / MT8121iE / MT8150iE*

MT-XE *MT8121XE / MT8150XE*

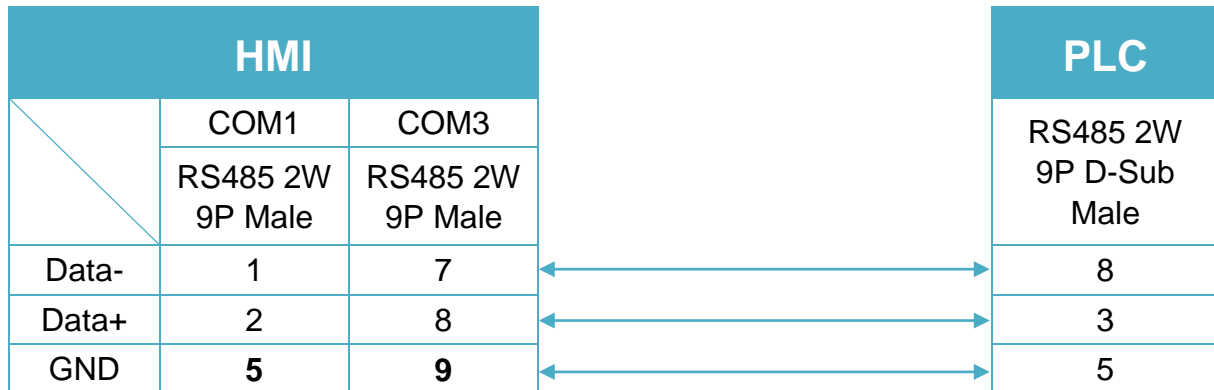


Diagram 4

MT-iE *MT8071iE / MT6071iE / MT8072iE / MT6072iE / MT8073iE /
MT8101iE / MT8102iE / MT8103iE*

MT-XE *MT8090XE / MT8092XE*

MT-iP *MT6103iP*

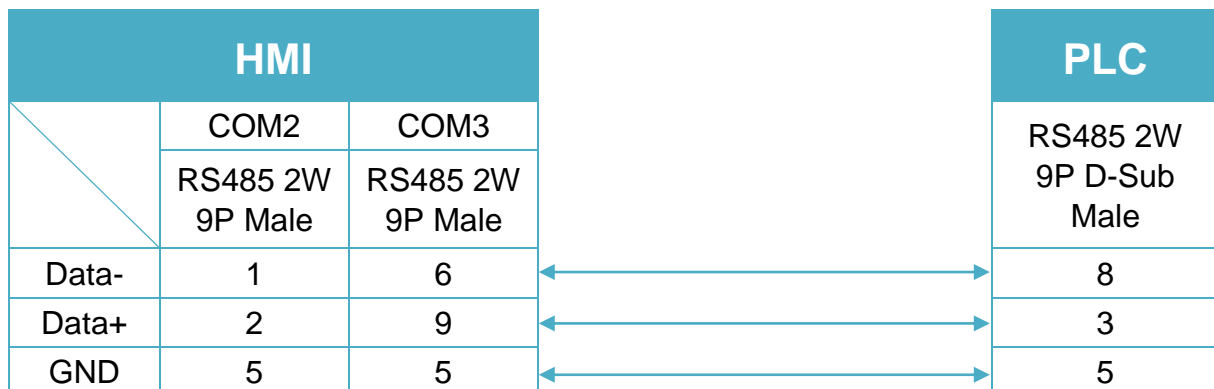
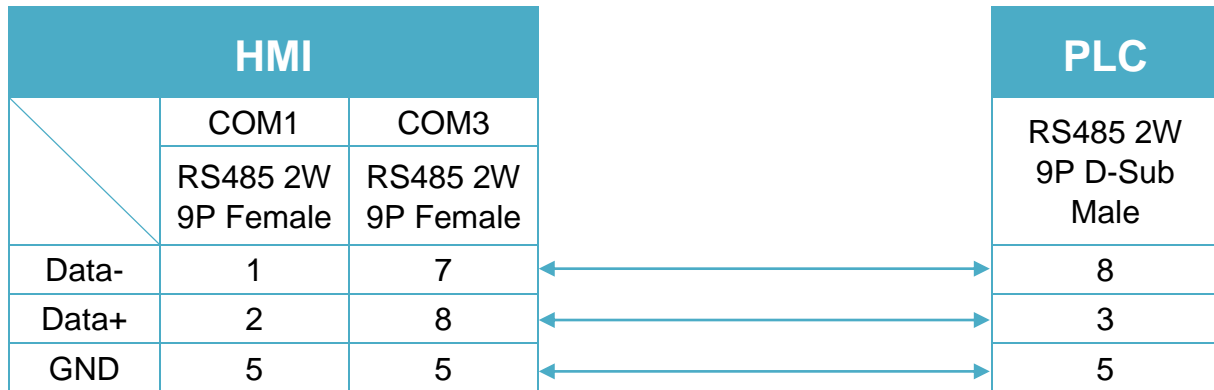


Diagram 5
MT-iE *MT8050iE*
MT-iP *MT6051iP*

Diagram 6
MT-iP *MT6071iP / MT8071iP*


Siemens S7-200 (Ethernet)

Supported Series: Siemens S7/200 Ethernet Series PLC

(CPU212/214/215/216/221/222/224/226/226XM) with CP243-1 Ethernet module

Website: <http://www.siemens.com/entry/cc/en/>

HMI Setting:

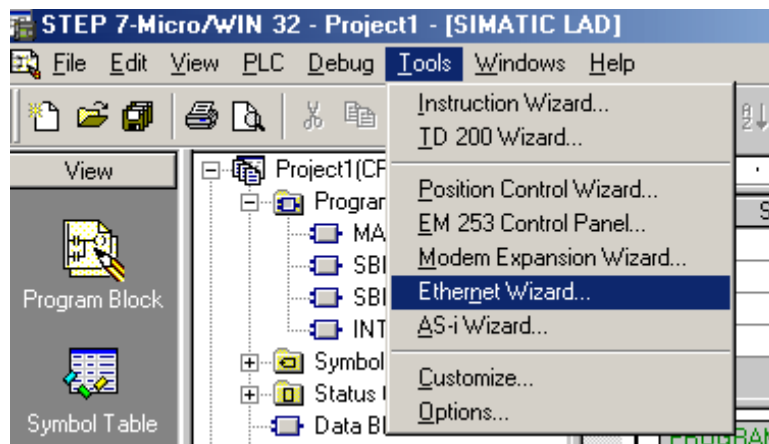
Parameters	Recommended	Options	Notes
PLC type	SIEMENS S7-200 (Ethernet)		
PLC I/F	Ethernet		
Port no.	102		
PLC sta. no.	1	0-31	

PLC Setting:

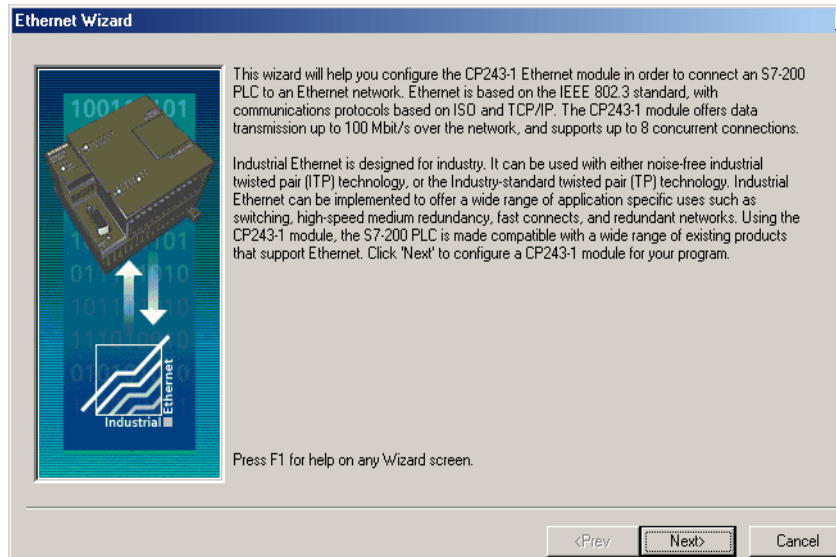
S7/200 Ethernet Multi-Connection Settings

Step 1: Launching the Ethernet Wizard

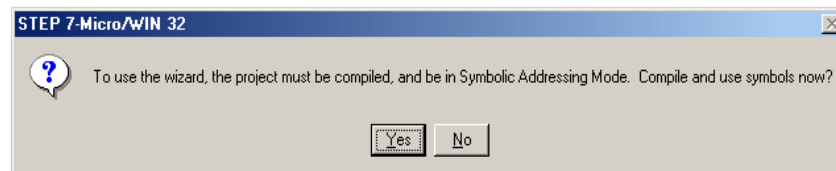
1. In the Micro/WIN main menu, click **Tools / Ethernet Wizard**.



2. Then, click **Next**.

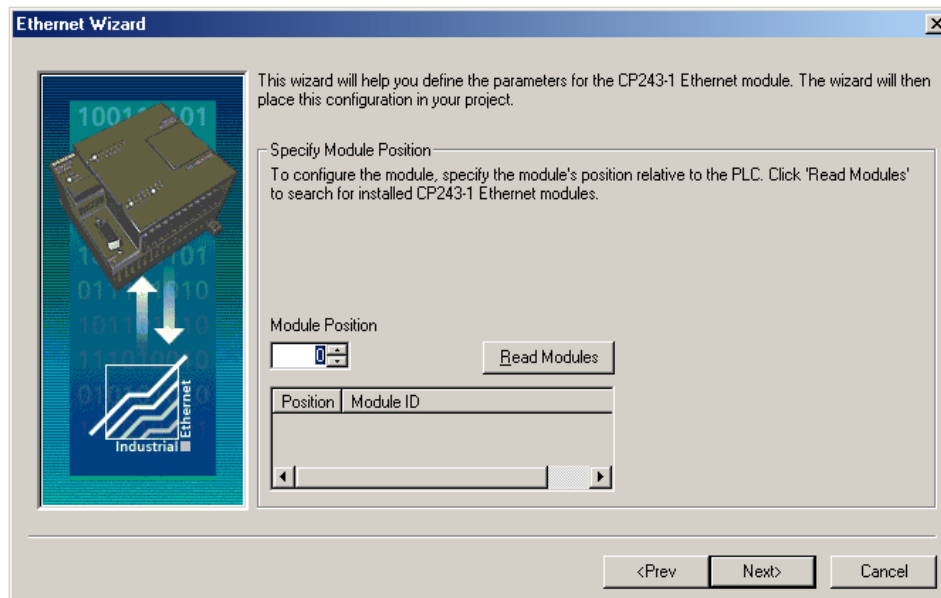


3. Click **Yes** to proceed.

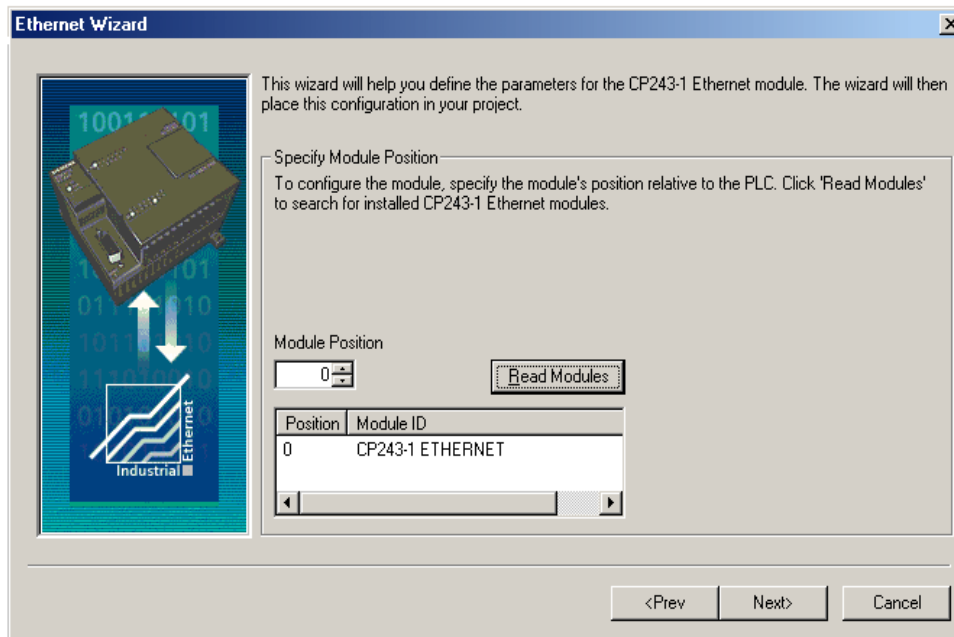


Step 2: Setting CP243-1 Module Position

1. Click **Read Modules**.

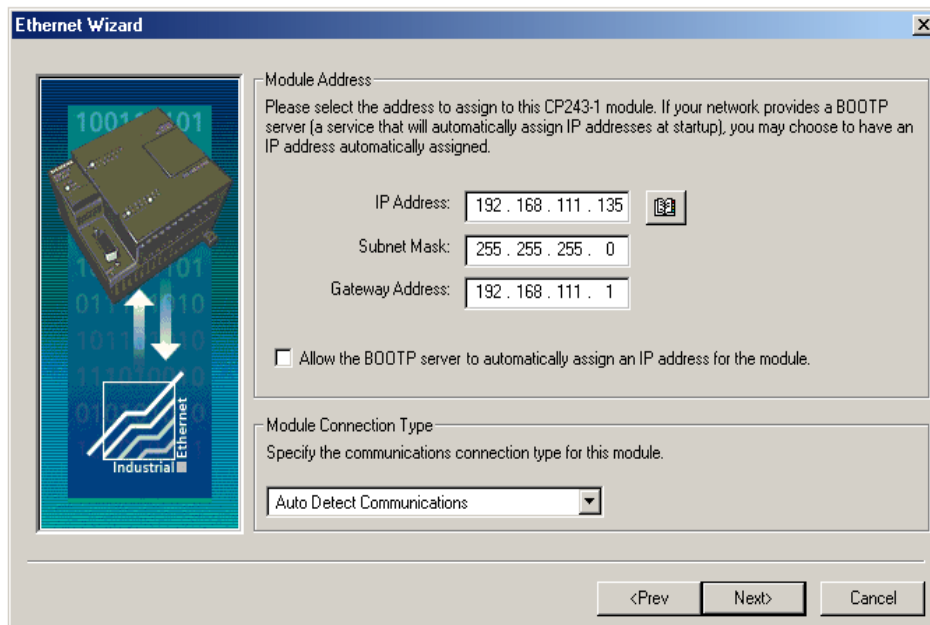


- To view the results of Read Modules, select the **Ethernet module**. Click **Next**.

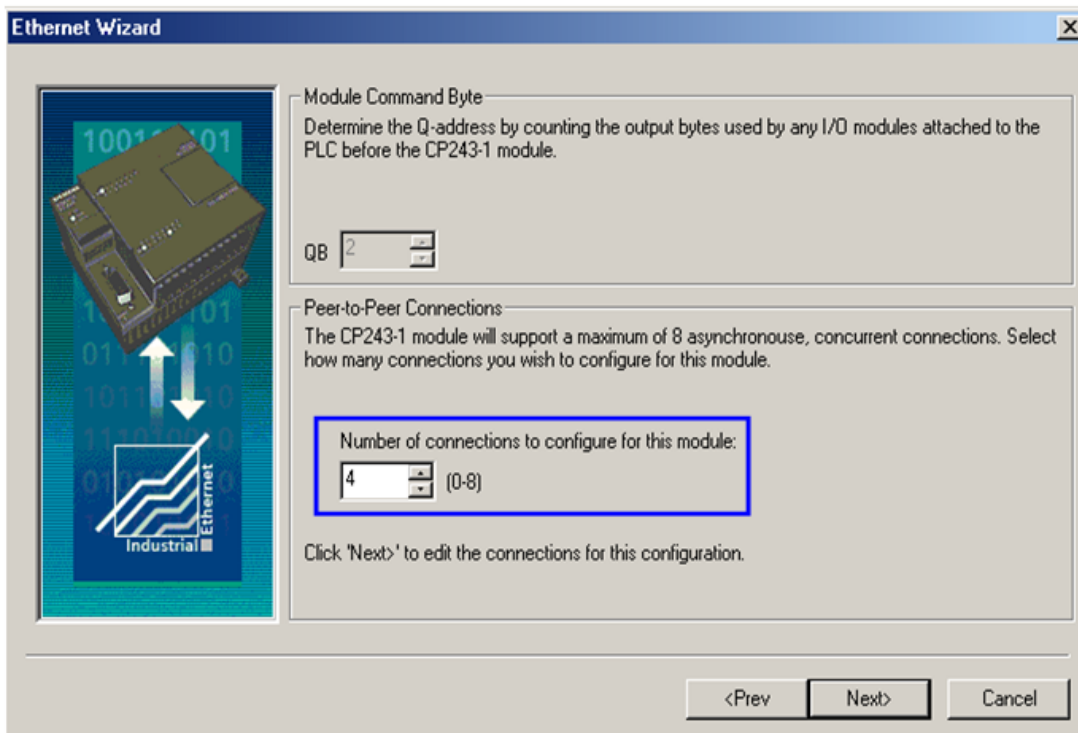


Step 3: Assigning Module Address

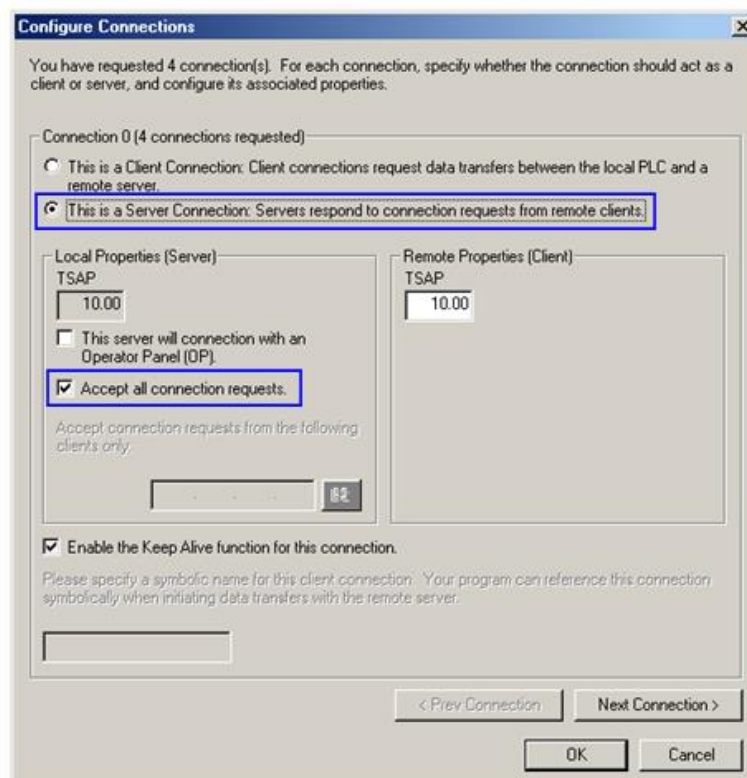
- Click **Next**.



2. Enter the number of desired available connections for this device. If 0 is entered, the only connection available will be the PG mode. The image below shows there are 4 connections for this module.

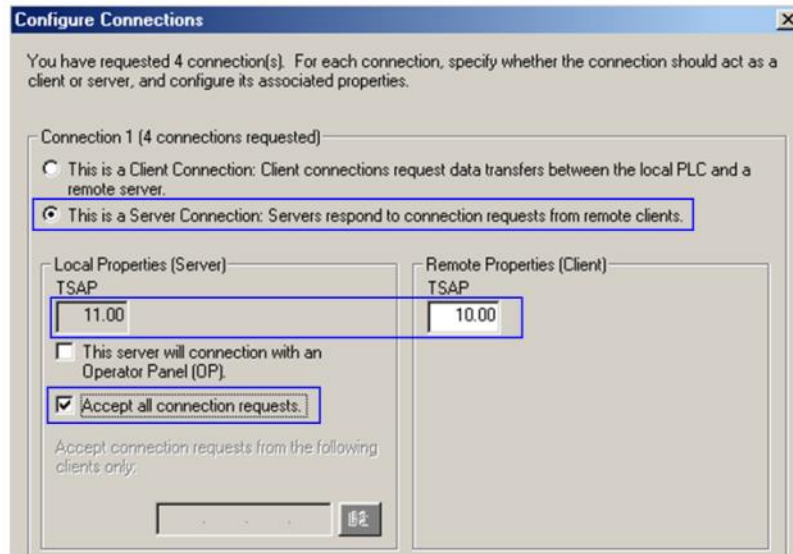


3. Connection0 -> Select **This is a Server Connection....**
Notice the **Local TSAP** automatically incremented to **10.00**.

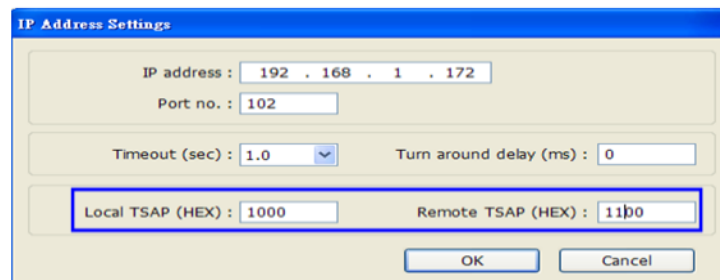


4. Connection1 › Select **This is a Server Connection....**

Notice the **Local TSAP** automatically incremented to **11.00**.



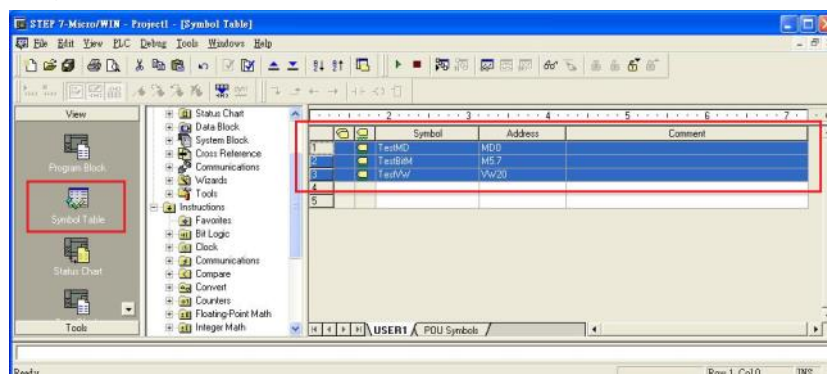
- Upon completion of the settings above, set parameters in EasyBuilder. Set the value of Local TSAP here to the value of Remote TSAP in Micro/WIN and vice versa to realize multi-connection.



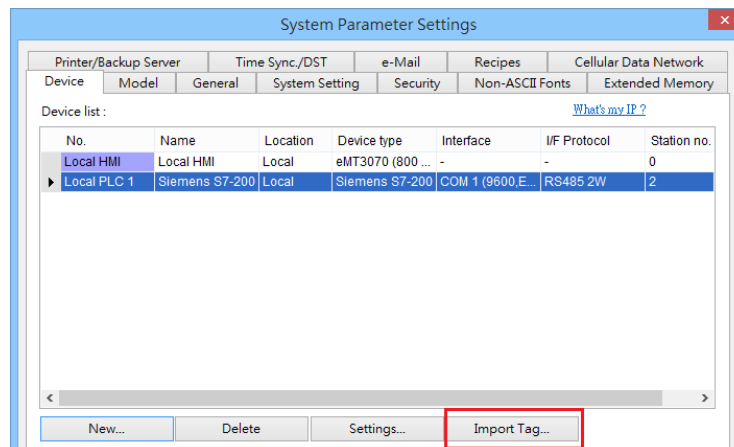
How to Import Tag:

The tags created in the Symbol Table in Step7-MicroWIN software can be imported to EasyBuilder.

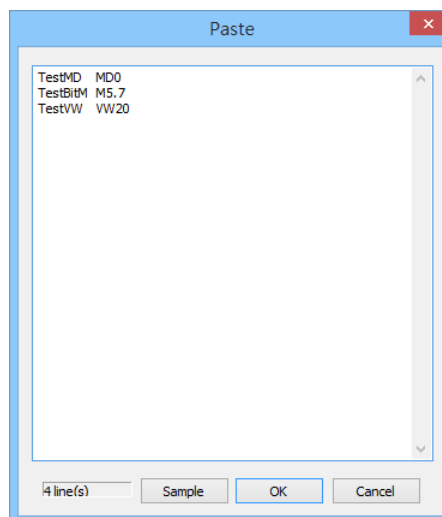
- In **Symbol Table** create the tags. Select all the tags and click the right mouse button then **copy** the tags.



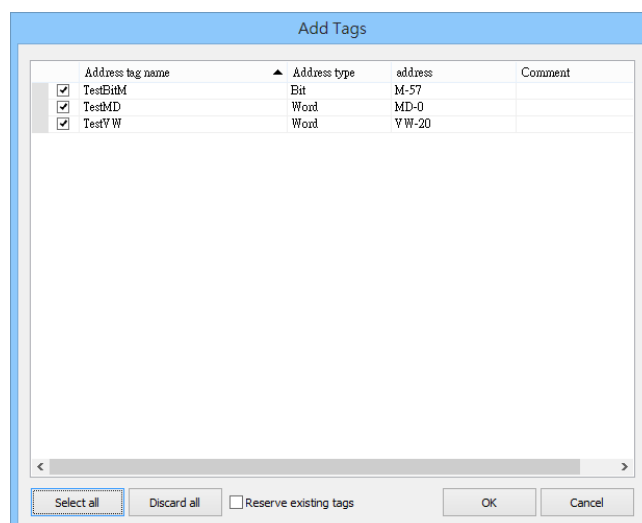
2. Launch EasyBuilder, add the driver in the device list in **System Parameter Settings**, and then click **Import Tag** button.



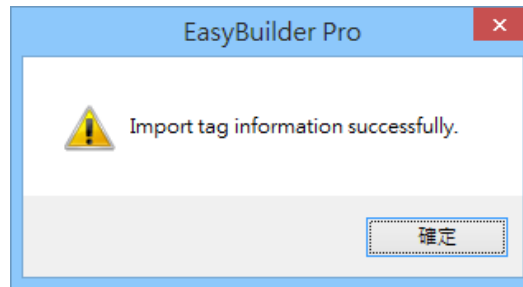
3. **Paste** the tags copied in step 1 and then click **OK**.



4. Select all the tags and then click **OK**.



5. If succeeded, the following message window shows.



Device Address:

Bit/Word	Device	Format	Range	Memo
B	I	DDDDo	0 ~ 40957	Input (I)
B	Q	DDDDo	0 ~ 40957	Output (O)
B	M	DDDDo	0 ~ 40957	Bit Memory
B	VW_Bit	DDDDDo	0 ~ 102397	V Memory Bit Address
B	S	DDDDo	0 ~ 40957	SCR
B	SM	DDDDo	0 ~ 40957	Special Memory
W	VW	DDDDD	0 ~ 10239	V Memory
DW	VD	DDDDD	0 ~ 10239	V Memory Double Word
W	VW_String	DDDDD	0 ~ 10239	String
DW	VD_String	DDDDD	0 ~ 10239	String
DW	MD	DDDDD	0 ~ 10239	Word Memory
Byte	VB	DDDDD	0 ~ 10239	V Memory Byte
Byte	SB	DDDDD	0 ~ 10239	SCR
W	SW	DDDDD	0 ~ 10239	SCR
DW	SD	DDDDD	0 ~ 10239	SCR
Byte	SMB	DDDDD	0 ~ 10239	Special Memory
W	SMW	DDDDD	0 ~ 10239	Special Memory
DW	SMD	DDDDD	0 ~ 10239	Special Memory

- Double word and floating point value must use VD device type.

Wiring Diagram:

Ethernet cable:



Siemens S7-200 (VD any address)

Supported Series: Siemens S7-200 series PLC
(CPU212/214/215/216/221/222/224/226/226XM)

Website: <http://www.siemens.com/entry/cc/en/>

HMI Setting:

Parameters	Recommen	Options	Notes
PLC type	Siemens S7-200 (VD any address)		
PLC I/F	RS485 2w	RS485 2w	
Baud rate	9600	9600, 19200, 187.5K	The HMI which has a sticker "MPI187.5" on the rear cover supports 187.5K
Data bits	8	7,8	
Parity	Even	Even, Odd, None	
Stop bits	1	1, 2	
PLC sta. no.	2	1 ~ 126	
Turn around delay	5		
Reserved 1	30		ACK delay time

Online simulator	YES	Extend address mode	NO
Broadcast command	NO		

PLC Setting:

Communication mode	Set station number to 2
---------------------------	-------------------------

Device Address:

Bit/Word	Device type	Format	Range	Memo
B	I	DDDDo	0 ~ 40957	Input (I)
B	Q	DDDDo	0 ~ 40957	Output (O)
B	M	DDDDo	0 ~ 40957	Bit Memory
B	VW_Bit	DDDDDo	0 ~ 102397	V Memory Bit Address
B	S	DDDDo	0 ~ 40957	SCR
B	SM	DDDDo	0 ~ 40957	Special Memory
W	VW	DDDDD	0 ~ 10239	V Memory

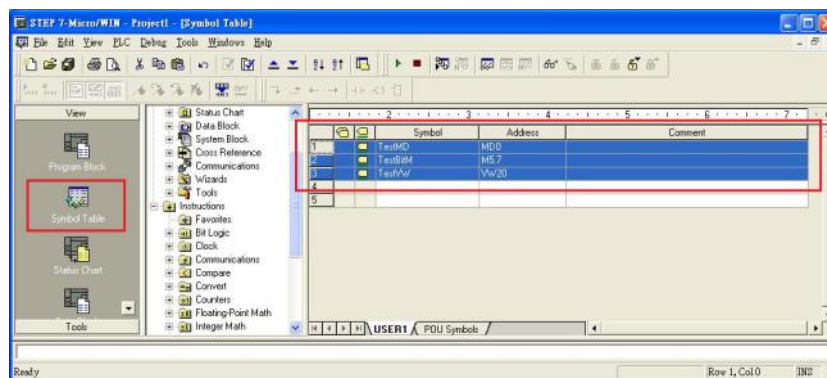
Bit/Word	Device type	Format	Range	Memo
DW	VD	DDDDD	0 ~ 10239	V Memory Double Word
W	VW_String	DDDDD	0 ~ 10239	String
DW	VD_String	DDDDD	0 ~ 10239	String
W	MW	DDDDD	0 ~ 10239	Word Memory
W	T	DDD	0 ~ 255	Timer
W	C	DDD	0 ~ 255	Counter
DW	MD	DDDDD	0 ~ 10239	Word Memory
Byte	SB	DDDDD	0 ~ 10239	SCR
W	SW	DDDDD	0 ~ 10239	SCR
DW	SD	DDDDD	0 ~ 10239	SCR
Byte	SMB	DDDDD	0 ~ 10239	Special Memory
W	SMW	DDDDD	0 ~ 10239	Special Memory
DW	SMD	DDDDD	0 ~ 10239	Special Memory

- Double word and floating point value must use VD device type.
- VD register can set to any value, not necessarily a multiple of 4.

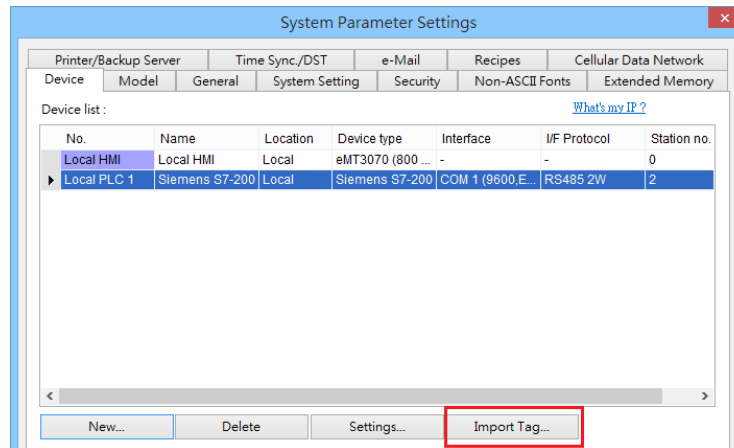
How to Import Tag:

The tags created in the Symbol Table in Step7-MicroWIN software can be imported to EasyBuilder.

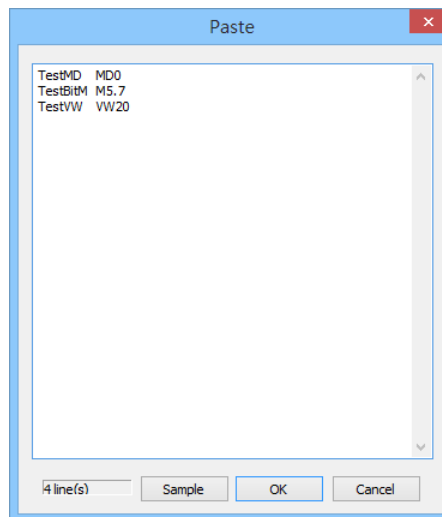
1. In **Symbol Table** create the tags. Select all the tags and click the right mouse button then **copy** the tags.



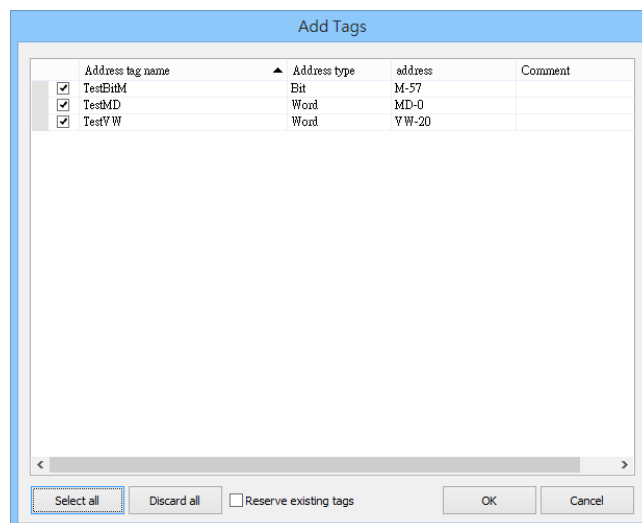
2. Launch EasyBuilder, add the driver in the device list in **System Parameter Settings**, and then click **Import Tag** button.



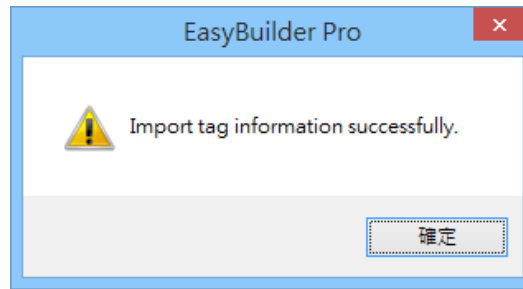
3. **Paste** the tags copied in step 1 and then click **OK**.



4. Select all the tags and then click **OK**.



5. If succeeded, the following message window shows.



Wiring Diagram:

Diagram 1

cMT Series

cMT3151

eMT Series

eMT3070 / eMT3105 / eMT3120 / eMT3150

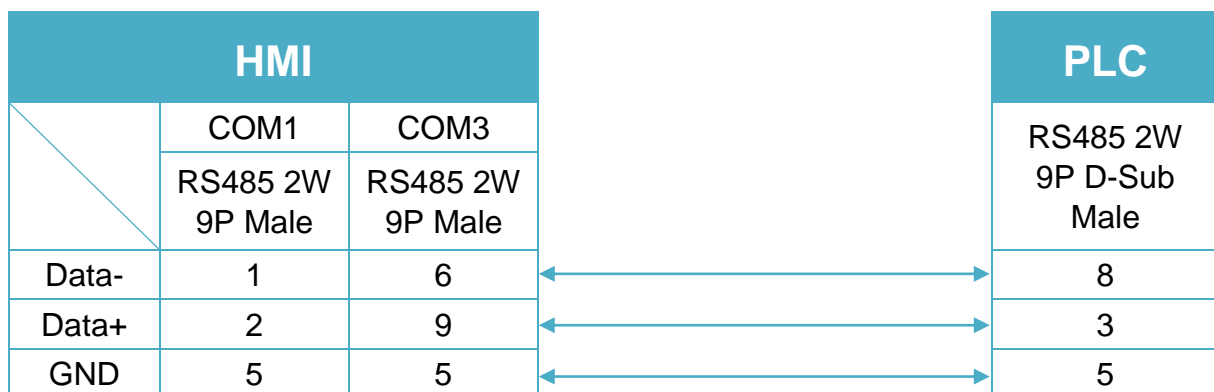


Diagram 2

cMT Series

cMT-SVR

mTV

mTV

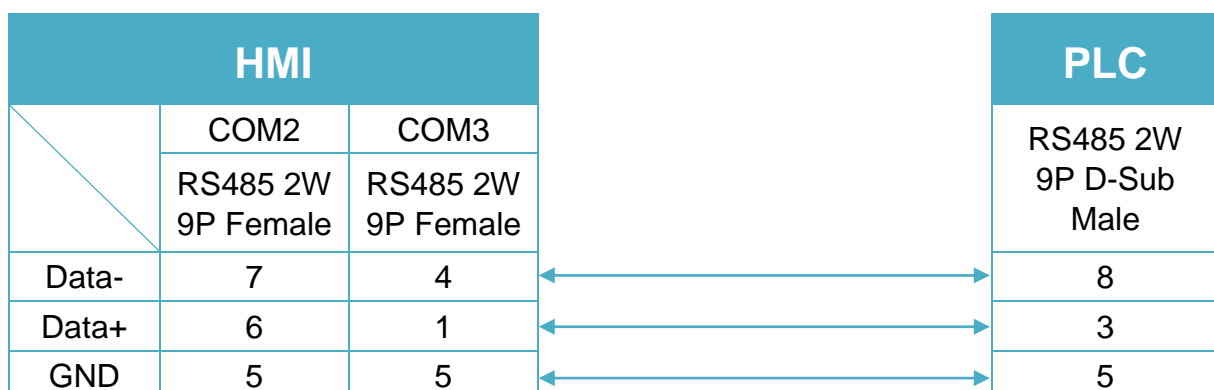


Diagram 3

MT-iE *MT8070iE / MT6070iE / MT8100iE / MT8121iE / MT8150iE*

MT-XE *MT8121XE / MT8150XE*

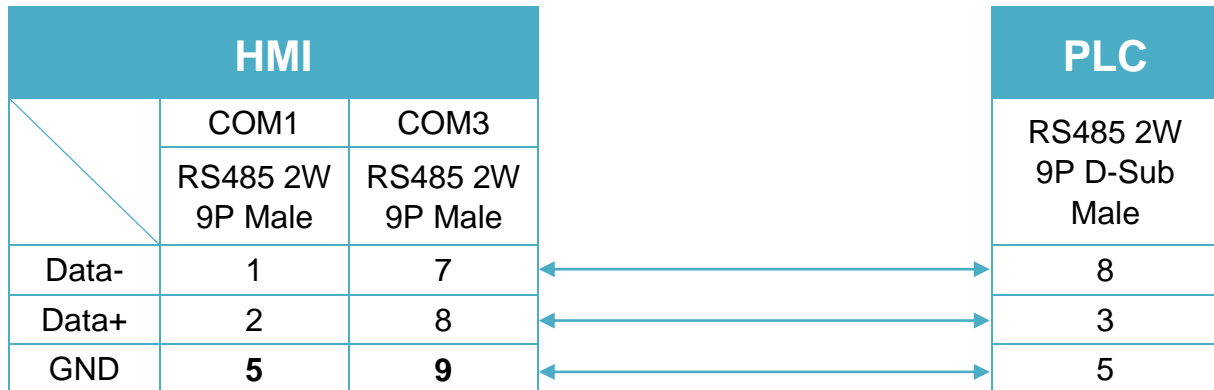


Diagram 4

MT-iE *MT8071iE / MT6071iE / MT8072iE / MT6072iE / MT8073iE /
MT8101iE / MT8102iE / MT8103iE*

MT-XE *MT8090XE / MT8092XE*

MT-iP *MT6103iP*

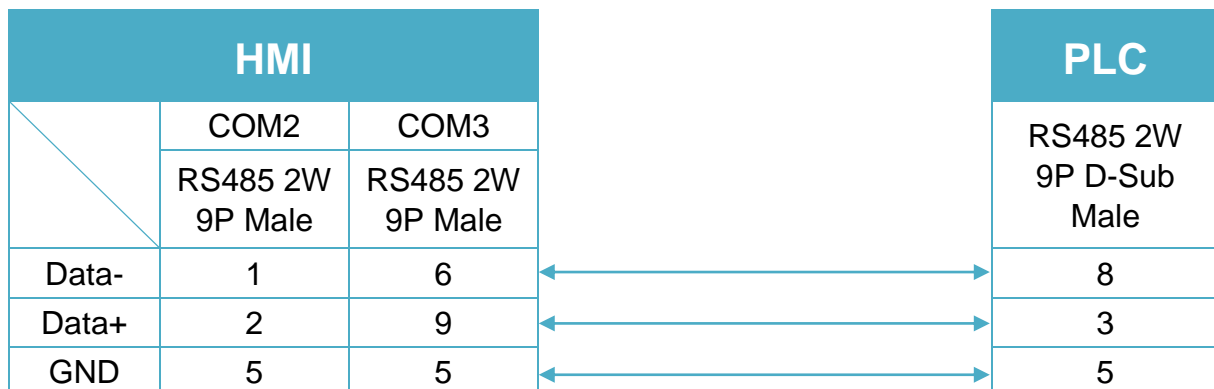
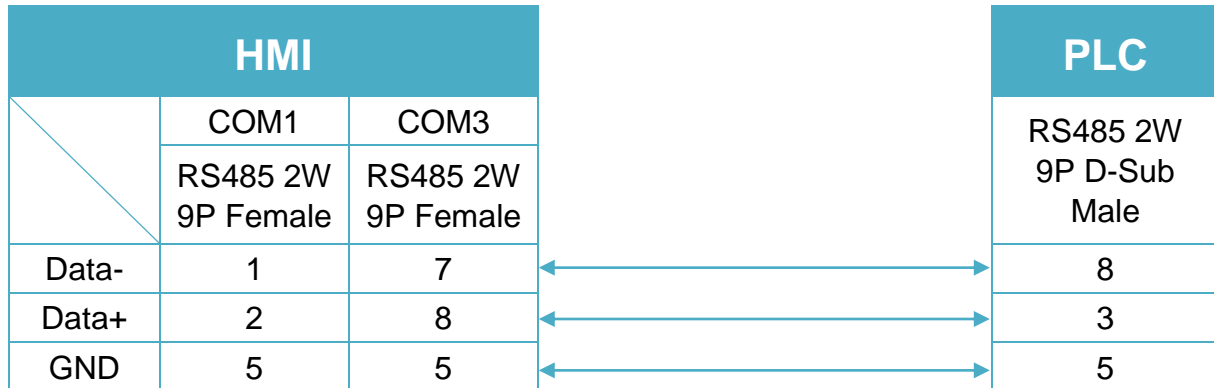
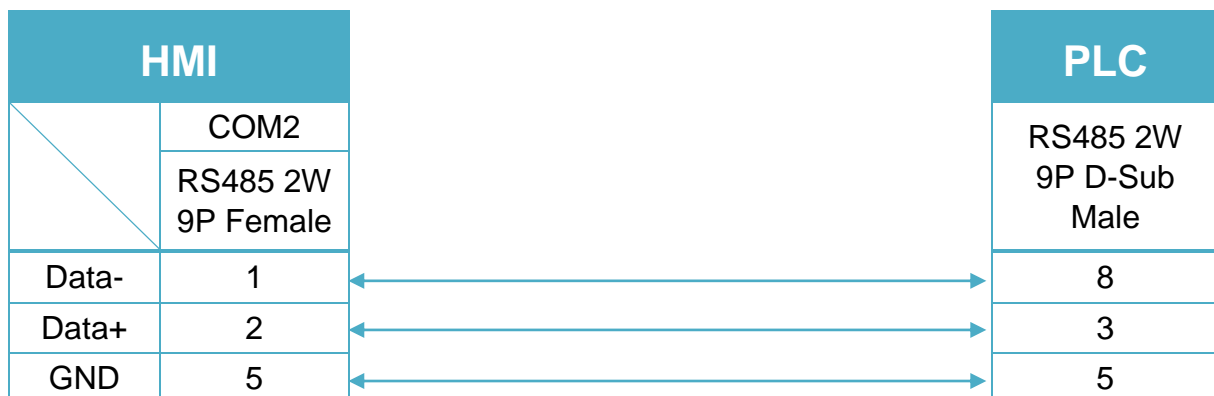


Diagram 5
MT-iE *MT8050iE*
MT-iP *MT6051iP*

Diagram 6
MT-iP *MT6071iP / MT8071iP*


Siemens S7-200 PPI

Supported Series: Siemens S7-200 series PLC
(CPU212/214/215/216/221/222/224/226/226XM)

Website: <http://www.siemens.com/entry/cc/en/>

HMI Setting:

Parameters	Recommended	Options	Notes
PLC type	SIEMENS S7-200 PPI		
PLC I/F	RS485 2w	RS485 2w	
Baud rate	9600	9600, 19200, 187.5K	Only MT6000/8000V2 support baud rate 187.5 K
Data bits	8	7,8	
Parity	Even	Even, Odd, None	
Stop bits	1	1, 2	
Turn around delay	5		
ACK delay time (ms)	30		
PLC sta. no.	2	1 ~ 126	

Online simulator	YES	Extend address mode	YES
Broadcast command	NO		

PLC Setting:

PLC setting	PLC sta. no. can not be the same as HMI sta. no.
-------------	--

Device Address:

Bit/Word	Device type	Format	Range	Memo
B	I	DDDDo	0 ~ 40957	Input (I)
B	Q	DDDDo	0 ~ 40957	Output (O)
B	M	DDDDo	0 ~ 40957	Bit Memory
B	VW_Bit	DDDDDo	0 ~ 102397	V Memory Bit Address
B	S	DDDDo	0 ~ 40957	SCR
B	SM	DDDDo	0 ~ 40957	Special Memory
B	T_Bit	DDD	0 ~ 255	Timer
B	C_Bit	DDD	0 ~ 255	Counter
Byte	VB	DDDDD	0 ~ 10239	

Bit/Word	Device type	Format	Range	Memo
W	VW	DDDDD	0 ~ 10239	V Memory
W	VW_Odd	DDDDD	0 ~ 10239	V Memory
DW	VD	DDDDD	0 ~ 10239	V Memory Double Word
DW	VD_Odd	DDDDD	0 ~ 10239	V Memory Double Word
W	VW_String	DDDDD	0 ~ 10239	String
W	VW_String_Odd	DDDDD	0 ~ 10239	String
DW	VD_String	DDDDD	0 ~ 10239	String
DW	VD_String_Odd	DDDDD	0 ~ 10239	String
Byte	MB	DDDDD	0 ~ 10239	Byte Memory
W	MW	DDDDD	0 ~ 10239	Word Memory
W	MW_Odd	DDDDD	0 ~ 10239	Word Memory
W	T	DDD	0 ~ 255	Timer
W	C	DDD	0 ~ 255	Counter
DW	MD	DDDDD	0 ~ 10239	Word Memory
Byte	SB	DDDDD	0 ~ 10239	SCR
W	SW	DDDDD	0 ~ 10239	SCR
DW	SD	DDDDD	0 ~ 10239	SCR
Byte	SMB	DDDDD	0 ~ 10239	Special Memory
W	SMW	DDDDD	0 ~ 10239	Special Memory
DW	SMD	DDDDD	0 ~ 10239	Special Memory

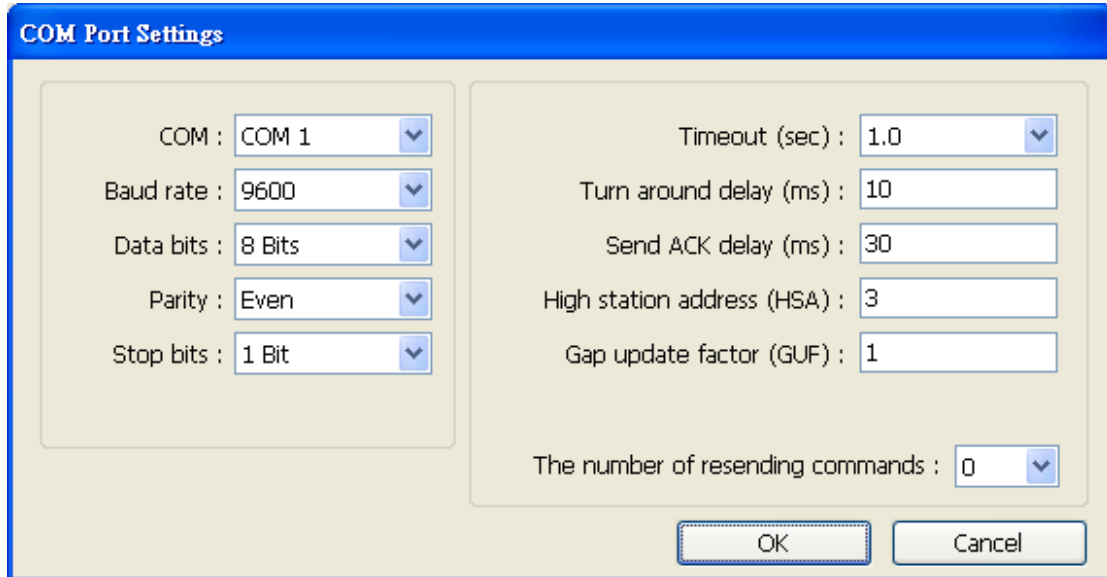
- Double Word and floating point value must use VD device type.

Multi-HMIs-Multi-PLCs Communication Setting:



For S7-200 PLC, Multi-HMIs-Multi-PLCs communication can be achieved using S7/200 PPI driver, please refer to the settings below.

IN EasyBuilder COM Port Settings, two important parameters must be set:

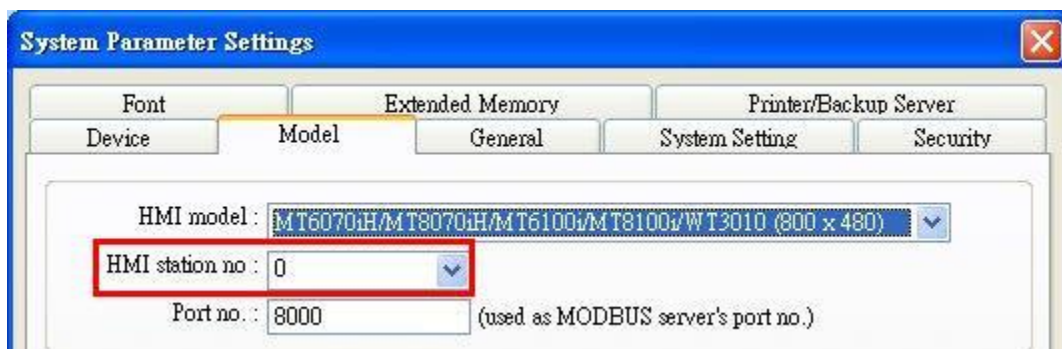


3. [High station address (HSA)]:

Setting Max. Station Number of HMI in PPI network.

For the effectiveness of system operation, it is highly recommended that the HMI station number starts from zero and go on sequentially. If there are 4 HMI in PPI network, set station no. from 0~3, and [High station address (HSA)] to 3.

Set HMI station number in [System Parameters] / [Model] / [HMI station no.]:



4. [Gap update factor(GUF)]:

The condition to pass a Token. In PPI network only HMI can hold a Token, PLC can only be controlled.

When the HMI that holds Token communicates with PLC for a number of times that equals to the value set here, HMI will pass the Token (control of PLC) to the next HMI. For example, if GUF is set to "1", HMI will pass the control of PLC to the next HMI when read or write the value in an address.

If GUF is set to a bigger value, the HMI that holds Token will control the PLC for a longer time and therefore the Token won't be passed to another HMI and cause failure in communicating with PLC.

A complete communication means HMI reads / writes PLC value for one time.

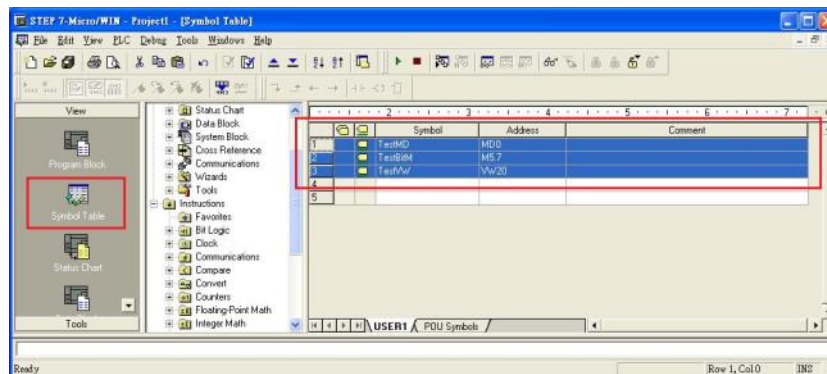
Note:

- HMI sta. no. can not be the same as PLC sta. no.
- Highly recommended that HMI sta. no. starts from 0 and go on sequentially for the effectiveness of operation.
- Available for EasyBuilder V4.50 and later.

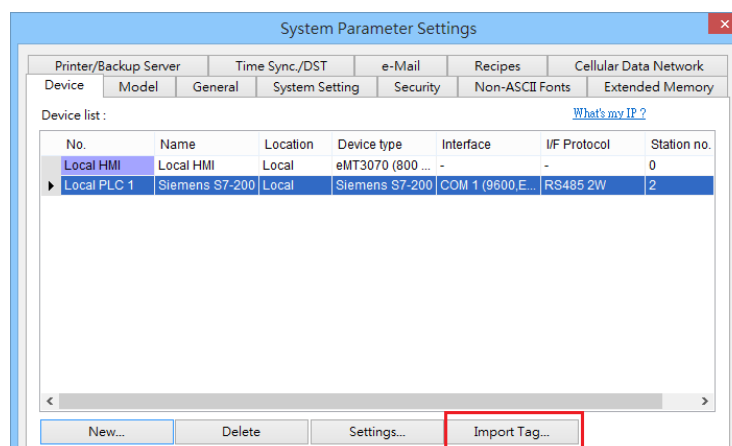
How to Import Tag:

The tags created in the Symbol Table in Step7-MicroWIN software can be imported to EasyBuilder.

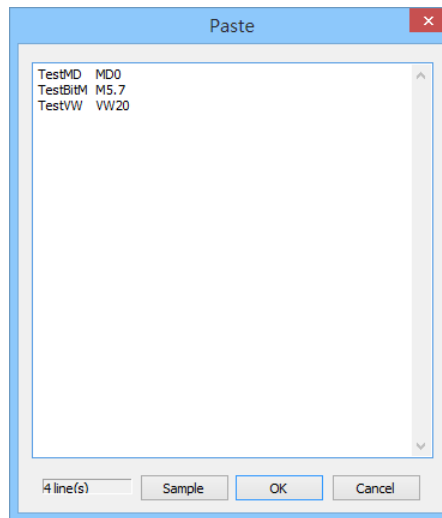
1. In **Symbol Table** create the tags. Select all the tags and click the right mouse button then **copy** the tags.



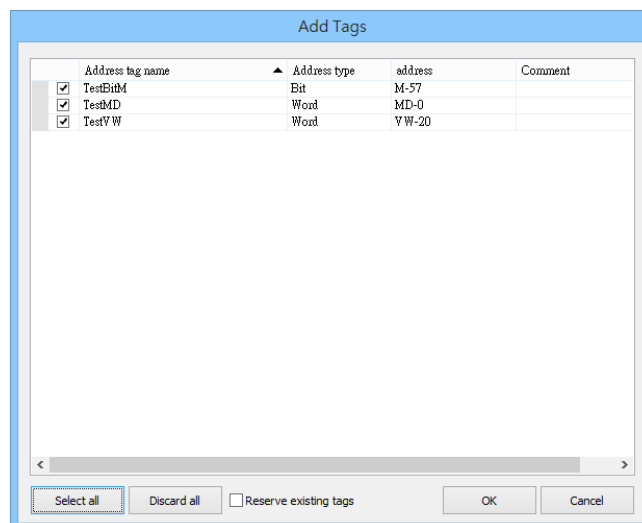
2. Launch EasyBuilder, add the driver in the device list in **System Parameter Settings**, and then click **Import Tag** button.



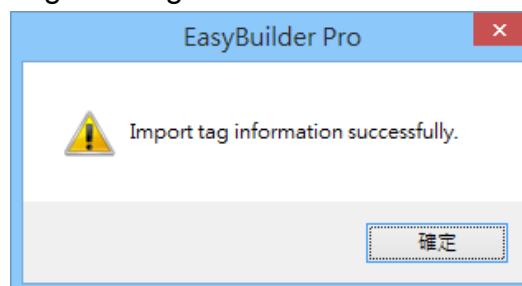
3. **Paste** the tags copied in step 1 and then click **OK**.



4. Select all the tags and then click **OK**.

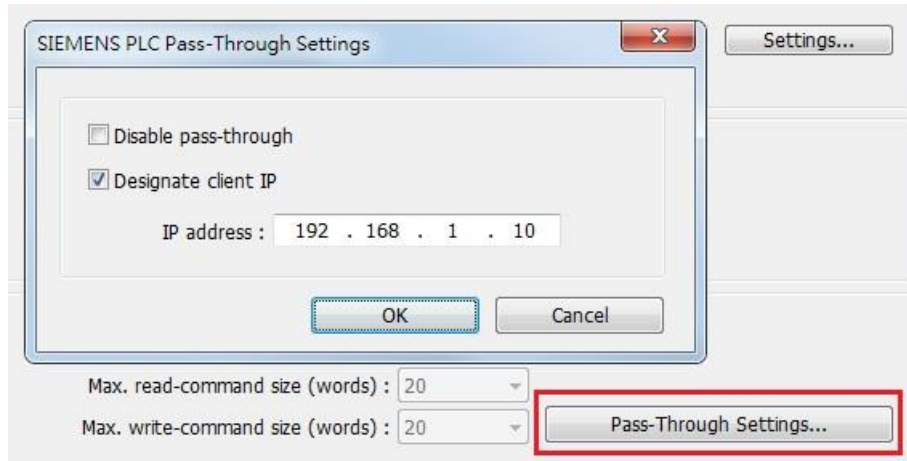


5. If succeeded, the following message window shows.



Pass-Through Settings:

[Designate client IP]: In Pass-through mode designate the client IP address to connect HMI. The “client” usually refers to Siemens Step 7 application.



The following lists the system registers relevant to Siemens S7-200 PPI and Siemens S7-300 MPI Pass-through feature.

- [LW-10850: disable/enable (0 : disable, 1 : normal, 2 : IP limited) (siemens pass-through)]
- [LW-10851: destination COM port (siemens pass-through)]: Generally refers to the COM port connected with PLC.
- [LW-10852: destination PLC station no. (siemens pass-through)]
- [LW-10853: communication protocol (0 : invalid, 1 : PPI, 2 : MPI) (siemens pass-through)]
- [LW-10854 to LW-10857: IP of connecting client (siemens pass-through)]: Displays current client IP address connected with HMI.
- [LW-10858 to LW-10861: IP of designated client (siemens pass-through)]: If LW-10850 is set to 1, the system registers can be used to designate the client IP connected with HMI.
- [LW-10862: connection status (0 : ready, 1 : client connecting) (siemens pass-through)]
- [LW-10863: execution status (0 : normal, 1 : error) (siemens pass-through)]
- [LW-10864: the last error (siemens pass-through)]

The following table lists the error codes, the description of each code, and the possible reason.

Error Code	Description	Possible Reason
0	Successfully executed	
1	Prohibit client from connecting HMI	HMI is already running pass-through and won't accept any request from other client.
2	Prohibit client from connecting HMI	When LW-10850 is set to 1, the client IP for connecting HMI is different from the IP specified in LW-10858 ~ LW-10861.
3	Invalid communication protocol	Invalid setting in LW-10853.
4	Invalid PLC station number	The PLC station number specified in LW-10852 does not exist.
5	Delayed communication	PLC connection failure.
6	Busy communication	PLC does not accept pass-through request, please confirm PLC settings.
7	Invalid pass-through request	Environment setup failure.

Wiring Diagram:

Diagram 1

cMT Series *cMT3151*

eMT Series *eMT3070/ eMT3105 / eMT3120 / eMT3150*

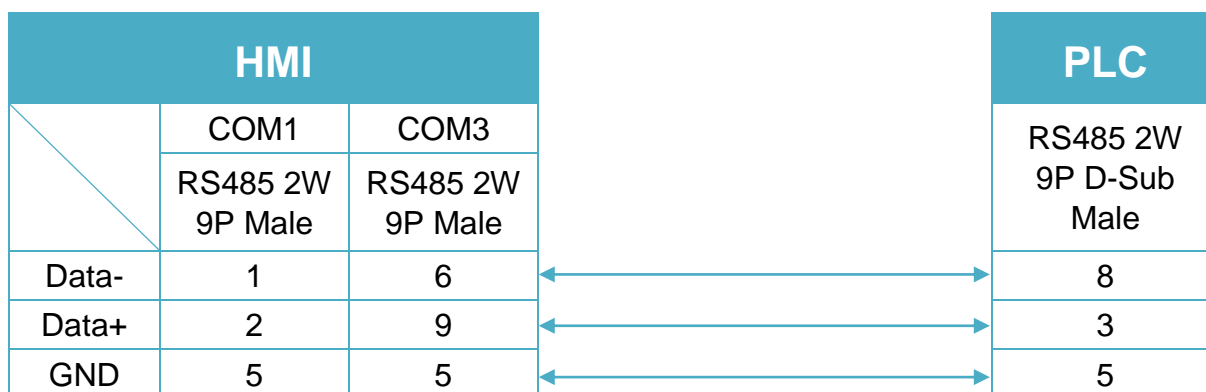


Diagram 2

cMT Series *cMT-SVR*

mTV *mTV*

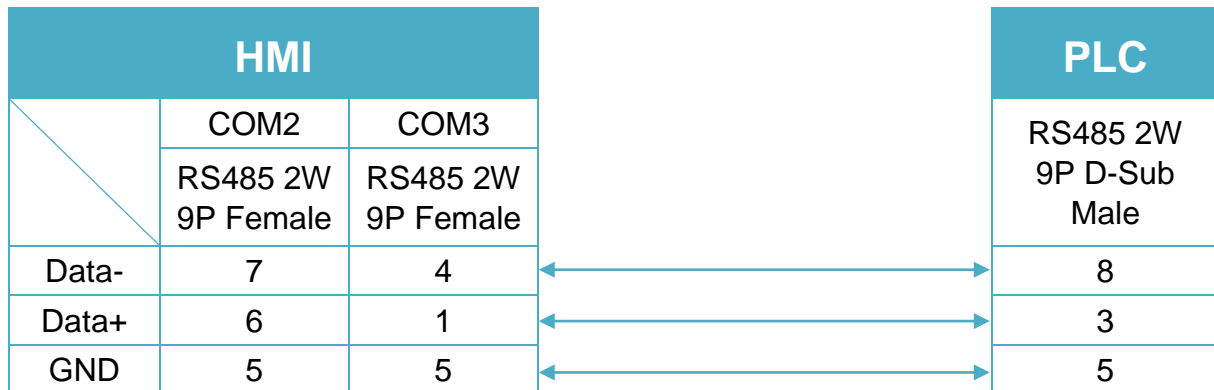


Diagram 3

MT-iE *MT8070iE / MT6070iE / MT8100iE / MT8121iE / MT8150iE*

MT-XE *MT8121XE / MT8150XE*

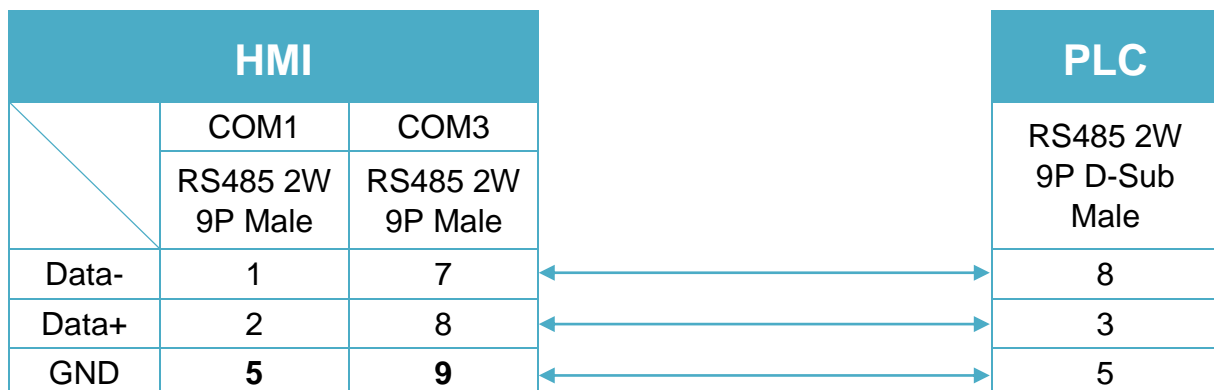
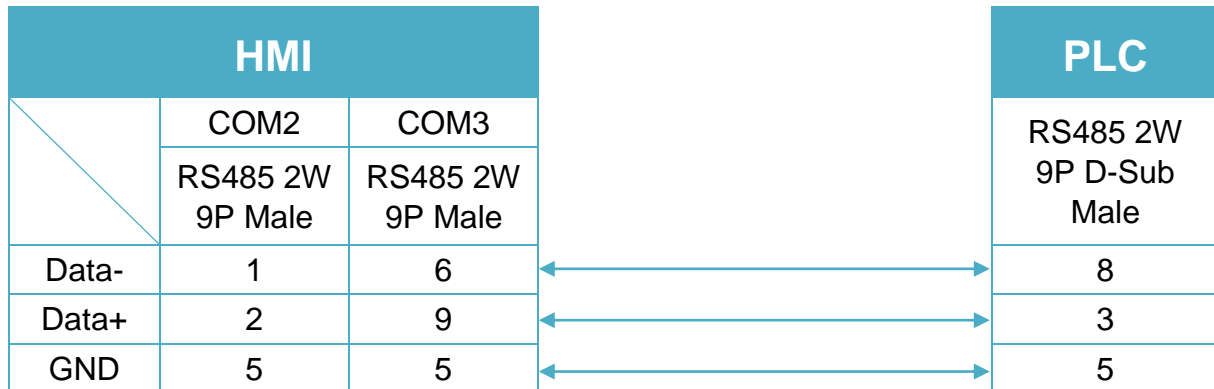
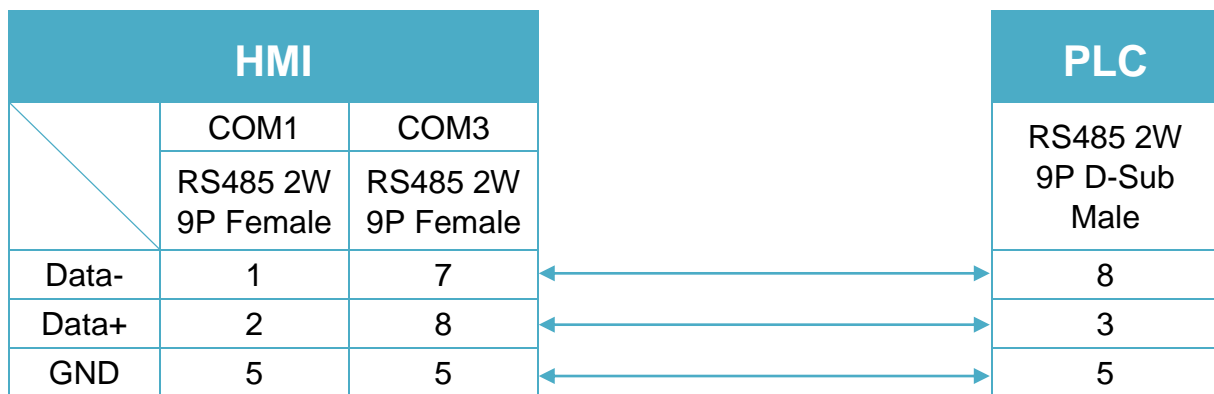


Diagram 4

MT-iE *MT8071iE / MT6071iE / MT8072iE / MT6072iE / MT8073iE /
MT8101iE / MT8102iE / MT8103iE*

MT-XE *MT8090XE / MT8092XE*

MT-iP *MT6103iP*


Diagram 5
MT-iE *MT8050iE*
MT-iP *MT6051iP*

Diagram 6
MT-iP *MT6071iP / MT8071iP*


Siemens S7-200 SMART (Ethernet)

Supported Series: Siemens S7/200 SMART Series Ethernet Module.

Website: <http://www.siemens.com/entry/cc/en/>

HMI Setting:

Parameters	Recommended	Options	Notes
PLC type	Siemens S7-200 SMART (Ethernet)		
PLC I/F	Ethernet		
Port no.	102		
PLC sta. no.	2		

Online simulator	Yes	Multiple HMI connection	Yes
-------------------------	-----	--------------------------------	-----

*At most four HMIs can be connected with PLC simultaneously.

Device Address:

Bit/Word	Device	Format	Range	Memo
B	I	DDo	0 ~ 317	Input
B	Q	DDo	0 ~ 317	Output
B	M	DDo	0 ~ 317	Bit Memory
B	V	DDDDDo	0 ~ 204797	V Memory Bit
B	S	DDo	0 ~ 317	SCR
B	SM	DDDDDo	0 ~ 15357	Special Memory Bit
B	Timer	DDD	0 ~ 255	Timer
B	Counter	DDD	0 ~ 255	Counter
W	MW	DD	0 ~ 30	Word Memory
W	VW	DDDDD	0 ~ 20478	V Memory
W	SMW	DDDD	0 ~ 1534	Special Memory
W	T	DDD	0 ~ 255	Timer
W	C	DDD	0 ~ 255	Counter
W	AIW	DDD	0 ~ 110	Analog Input
W	AQW	DDD	0 ~ 110	Analog Output
DW	VD	DDDDD	0 ~ 20476	V Memory (Double Word)
Byte	VB	DDDD	0 ~ 8191	V Memory Byte

- Double word and floating point value must use VD device type.

Wiring Diagram:

Ethernet cable:



Siemens S7-200 SMART PPI

Supported Series: Siemens S7-200 SMART series PLC

Website: <http://www.siemens.com/entry/cc/en/>

HMI Setting:

Parameters	Recommended	Options	Notes
PLC type	Siemens S7-200 SMART PPI		
PLC I/F	RS485 2W	RS485 2W	
Baud rate	9600	9600, 19200, 187.5K	Only MT6000/8000V2 support baud rate 187.5 K
Data bits	8	7,8	
Parity	Even	Even, Odd, None	
Stop bits	1	1, 2	
Turn around delay	5		
ACK delay time (ms)	30		
PLC sta. no.	2	1 ~ 126	

Online simulator	YES	Extend address mode	NO
Broadcast command	NO		

PLC Setting:

PLC setting	PLC sta. no. can not be the same as HMI sta. no.
--------------------	--

Device Address:

Bit/Word	Device type	Format	Range	Memo
B	I	DDo	0 ~ 317	Input
B	Q	DDo	0 ~ 317	Output
B	M	DDo	0 ~ 317	Bit Memory
B	V	DDDDDo	0 ~ 204797	V Memory bit
B	S	DDo	0 ~ 317	SCR
B	SM	DDDDDo	0 ~ 15357	Special Memory Bit
B	Timer	DDD	0 ~ 255	Timer
B	Counter	DDD	0 ~ 255	Counter
W	MW	DD	0 ~ 30	Word Memory
W	VW	DDDDD	0 ~ 20478	V Memory

Bit/Word	Device type	Format	Range	Memo
W	SMW	DDDD	0 ~ 1534	Special Memory
W	T	DDD	0 ~ 255	Timer
W	C	DDD	0 ~ 255	Counter
W	AIW	DDD	0 ~ 110	Analog input
W	AQW	DDD	0 ~ 110	Analog Output
DW	VD	DDDDD	0 ~ 20476	V Memory (Double Word)
Byte	VB	DDDD	0 ~ 8191	V Memory (Byte)

- Double Word and floating point value must use VD device type.

Wiring Diagram:

Diagram 1

cMT Series

cMT3151

eMT Series

eMT3070/ eMT3105 / eMT3120 / eMT3150

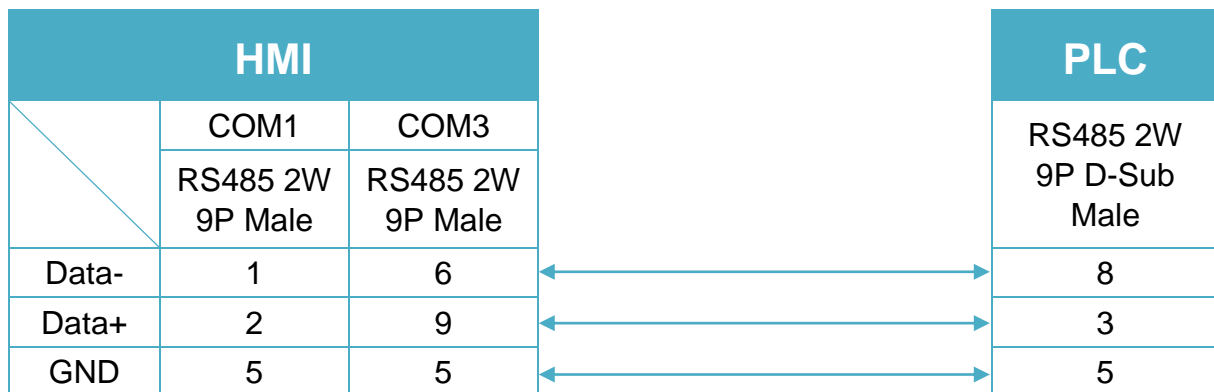


Diagram 2

cMT Series

cMT-SVR

mTV

mTV

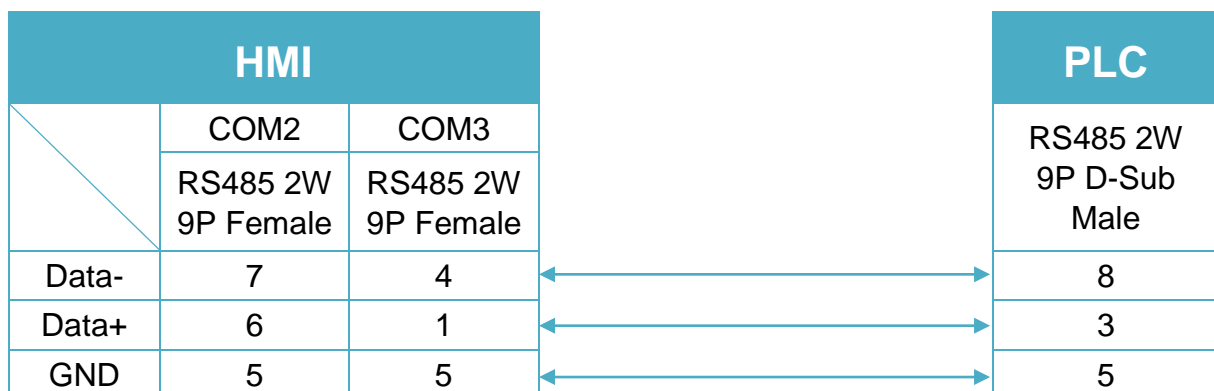


Diagram 3

MT-iE *MT8070iE / MT6070iE / MT8100iE / MT8121iE / MT8150iE*

MT-XE *MT8121XE / MT8150XE*

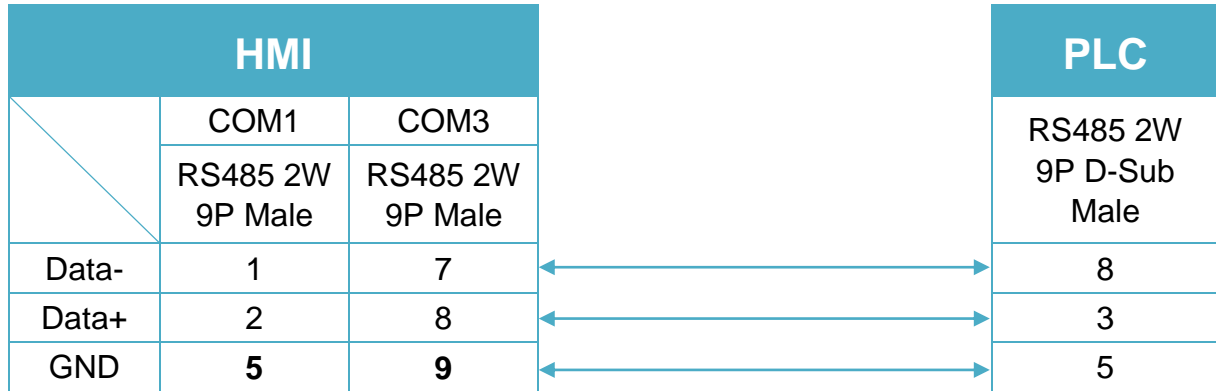


Diagram 4

MT-iE *MT8071iE / MT6071iE / MT8072iE / MT6072iE / MT8073iE /
MT8101iE / MT8102iE / MT8103iE*

MT-XE *MT8090XE / MT8092XE*

MT-iP *MT6103iP*

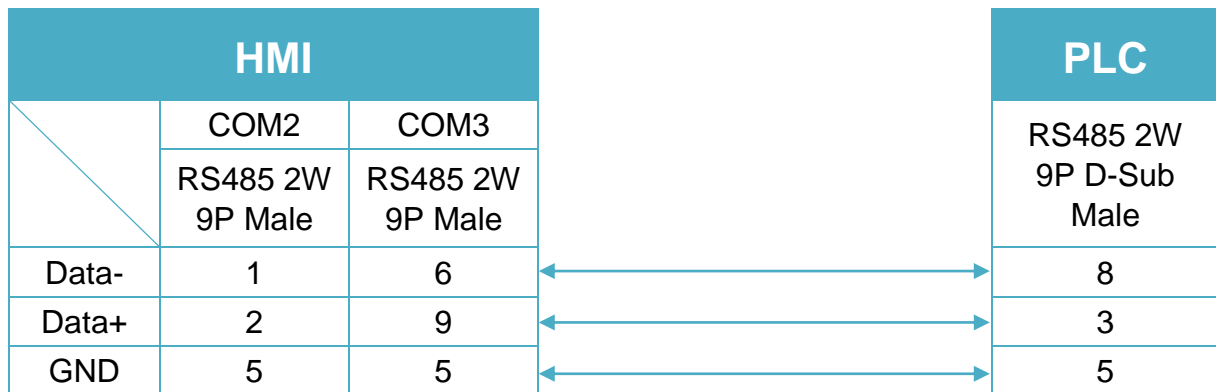
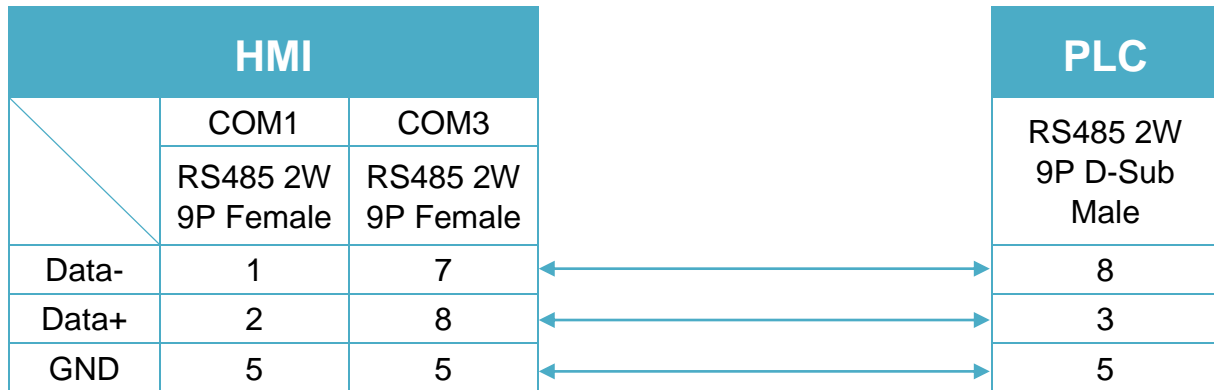


Diagram 5
MT-iE *MT8050iE*
MT-iP *MT6051iP*

Diagram 6
MT-iP *MT6071iP / MT8071iP*


Siemens S7-300

Supported Series: Siemens S7-300 series PLC

Website: <http://www.siemens.com/entry/cc/en/>

HMI Setting:

Parameters	Recommended	Options	Notes
PLC type	SIEMENS S7-300		
PLC I/F	RS232		
Baud rate	19200	9600,19200	
Data bits	8		
Parity	Odd		
Stop bits	1		
PLC sta. no.	2		Must be same as the PLC setting.

Device Address:

Bit/Word	Device type	Format	Range	Memo
B	I	DDDDo	0 ~ 40957	Input (I)
B	Q	DDDDo	0 ~ 40957	Output (O)
B	M	DDDDo	0 ~ 40957	Bit Memory
B	DBnBit	FFFFFFDDDDo	0 ~ 655359997	Data Register Bit
B	DBxBit	FFFFFFDDDDDo	0 ~ 10700655327	
B	DB1Bit ~ DB99Bit	DDDDDo	0 ~ 655327	
W	IW	DDDD	0 ~ 4095	Input (I)
W	QW	DDDD	0 ~ 4095	Output (O)
W	MW	DDDD	0 ~ 4095	Bit Memory
DW	MD	DDDD	0 ~ 4094	
Byte	MB	DDDD	0 ~ 4095	Bit Memory Byte
Byte	DBBn	FFFFFFDDDD	0 ~ 655359999	Data Register Byte
Byte	DBBx	FFFFFFDDDD	0 ~ 1070065532	
W	DBx	FFFFFFDDDD	0 ~ 1070065532	
W	DBn	FFFFFFDDDD	0 ~ 655359999	Data Register (must be even)
DW	DBDn	FFFFFFDDDD	0 ~ 655359999	Data Register Double Word (must be even)
DW	DBDx	FFFFFFDDDD	0 ~ 1070065532	

Bit/Word	Device type	Format	Range	Memo
W	DBn_String	FFFFFFDDDD	0 ~ 655359999	
W	DBx_String	FFFFFFDDDD	0 ~ 1070065532	
W	DBn_String1	FFFFFFDDDD	0 ~ 655359999	
W	DBx_String1	FFFFFFDDDD	0 ~ 1070065532	
DW	DBDn_String	FFFFFFDDDD	0 ~ 655359999	Data Register Double Word (must be even)
DW	DBDx_String	FFFFFFDDDD	0 ~ 1070065532	
W	DB1-DB99	DDDD	0 ~ 8192	Data Register

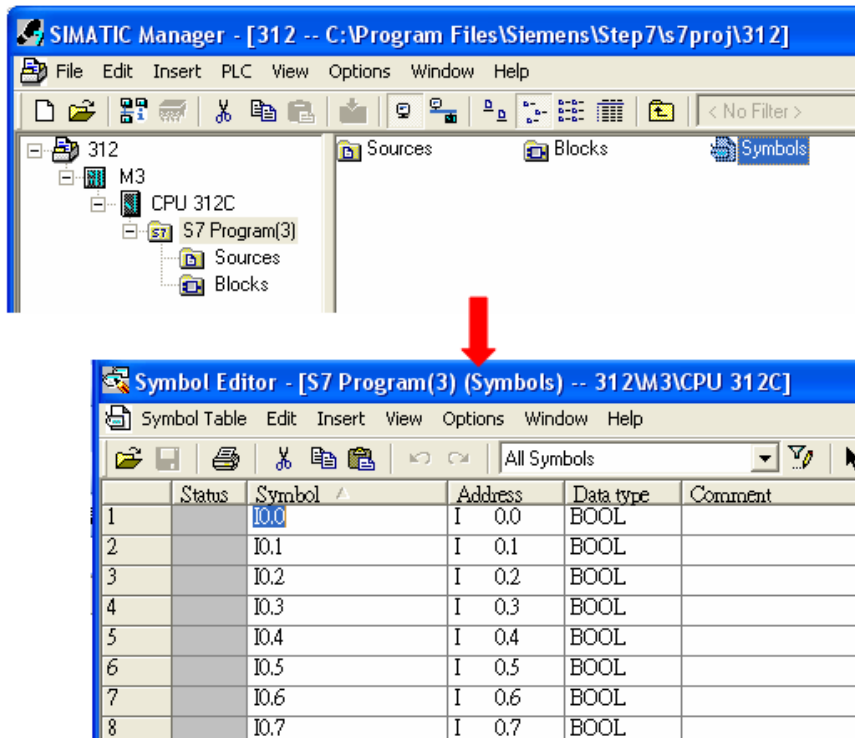
* Double word and floating point value must use DBDn device type.

How to Import Tag:

SIEMENS STEP 7 program allows building files of user-defined tag (*.dif file and *.AWL file), and import these files in EasyBuilder8000/EasyBuilderPro -> System Parameter Settings. The following describes how to build and import these two types of files.

1. Building *.dif File

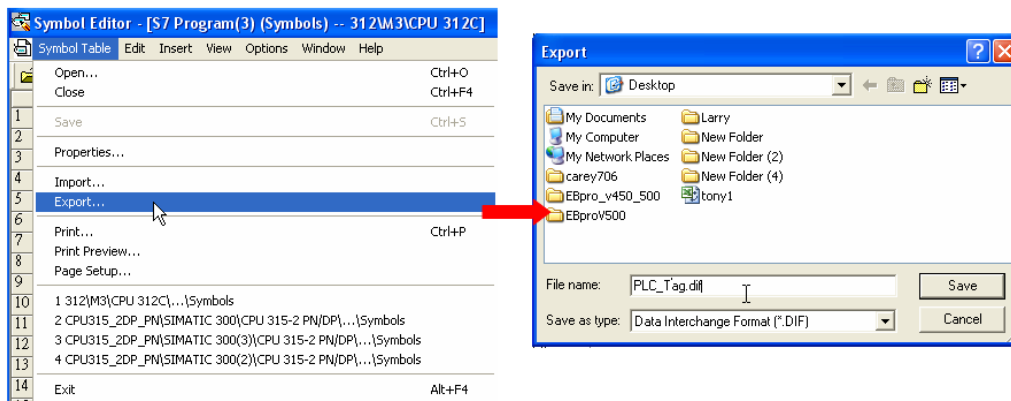
- a. In "Symbols" create user-defined tag.



The screenshot shows the SIMATIC Manager interface. The project tree on the left shows a project named '312' containing a sub-project 'M3' with a 'CPU 312C' and an 'S7 Program(3)'. The 'S7 Program(3)' contains 'Sources' and 'Blocks'. The 'Symbols' window is open, showing a table of symbols.

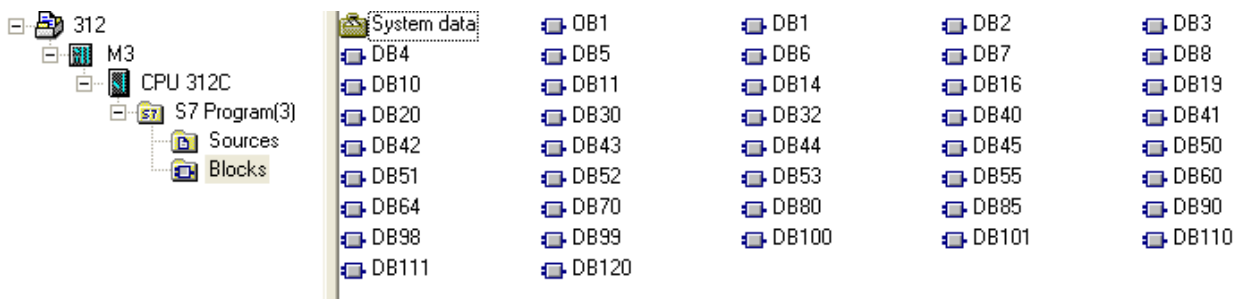
Status	Symbol	Address	Data type	Comment
	I0.0	I 0.0	BOOL	
	I0.1	I 0.1	BOOL	
	I0.2	I 0.2	BOOL	
	I0.3	I 0.3	BOOL	
	I0.4	I 0.4	BOOL	
	I0.5	I 0.5	BOOL	
	I0.6	I 0.6	BOOL	
	I0.7	I 0.7	BOOL	

b. Click **Export** to export the edited file and click **Save**.

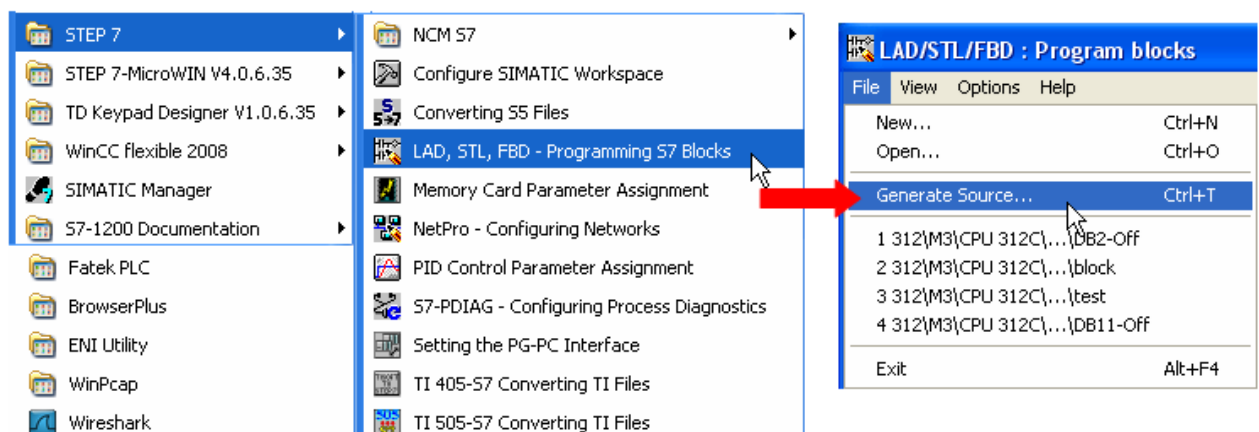


2. Building *.AWF File

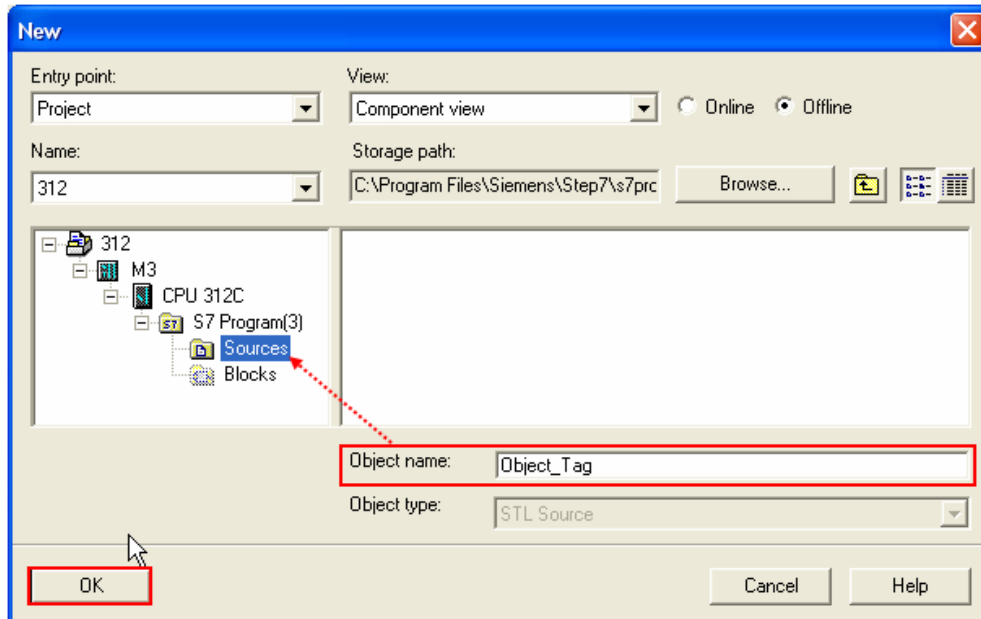
a. In **Blocks** create items as shown below:



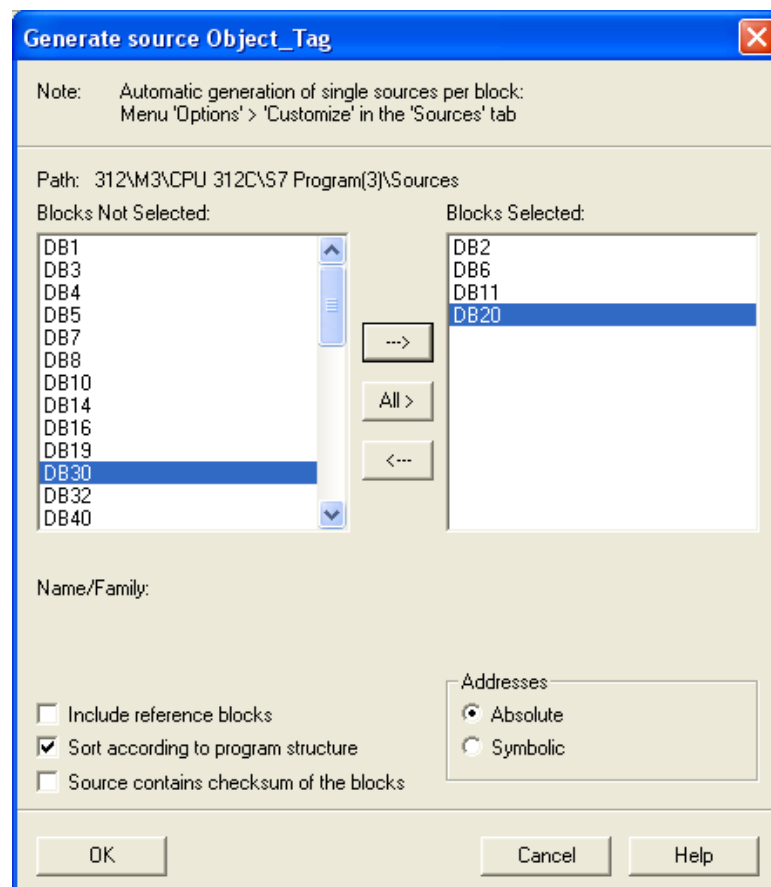
b. Open **LAD/STL, FBD – Programming S7 Blocks**, click **File -> Generate Source**.



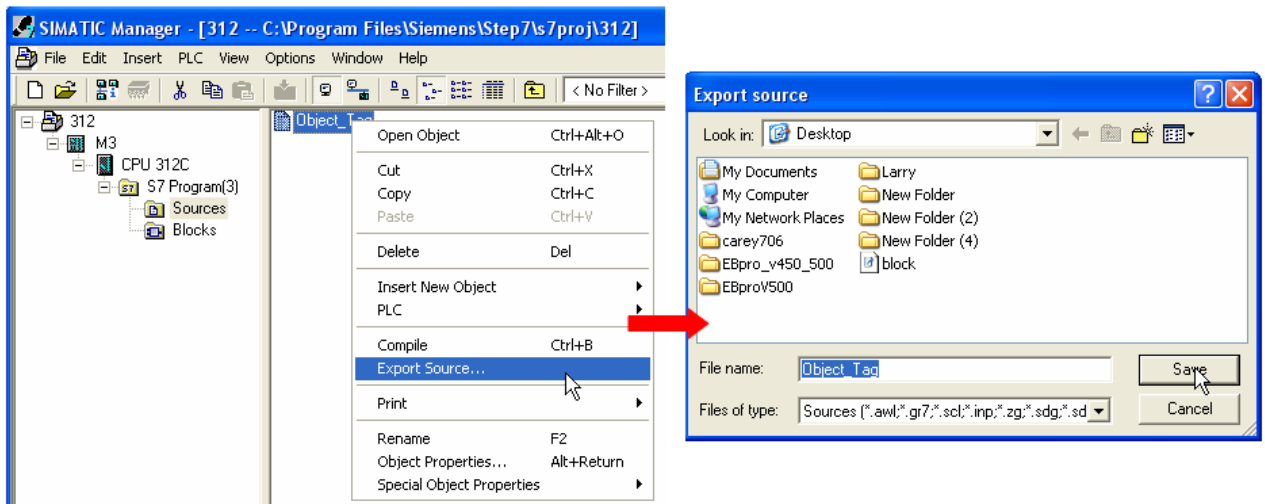
- c ․ Select **Sources** as storage path, specify the file name then click **OK**.



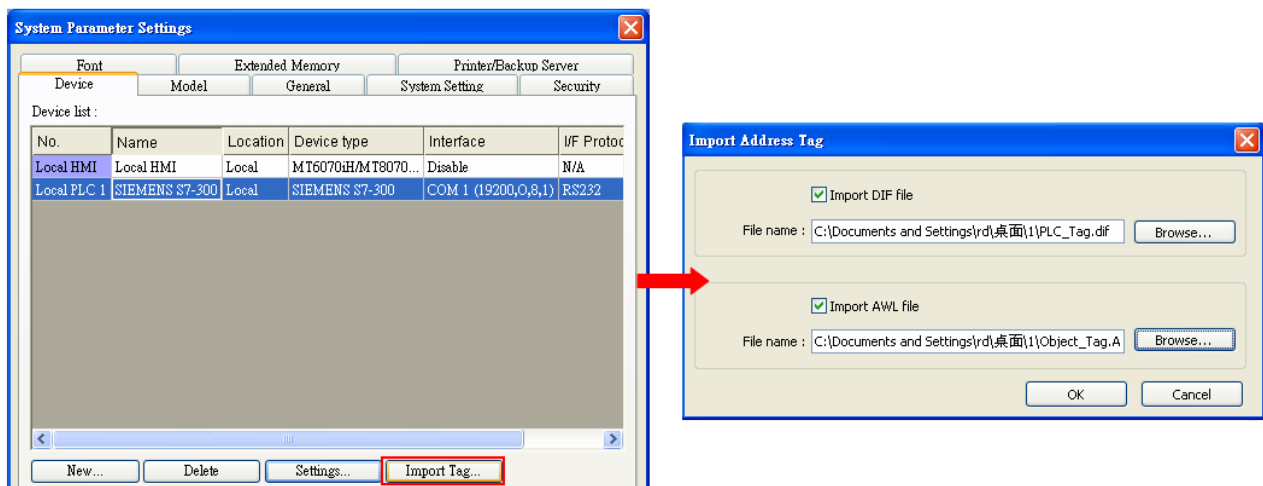
- d ․ Select the objects to be exported then click **OK**.



e、 Under **Sources** there will be names of the saved files, select **Export Source** to build *.AWL file.



The generated *.dif and *.AWL files can be imported in EasyBuilder8000/EasyBuilderPro **System Parameter Settings**, by clicking **Import Tag**.



Tag information successfully imported.



Wiring Diagram:

Siemens S7-300 PC Adapter : 9P D-Sub to 9P D-Sub (Diagram 1 ~ Diagram 3)

Diagram 1

cMT Series	<i>cMT3151</i>
eMT Series	<i>eMT3070/ eMT3105 / eMT3120 / eMT3150</i>
MT-iE	<i>MT8073iE / MT8102iE</i>
MT-XE	<i>MT8092XE</i>
MT-iP	<i>MT6103iP</i>

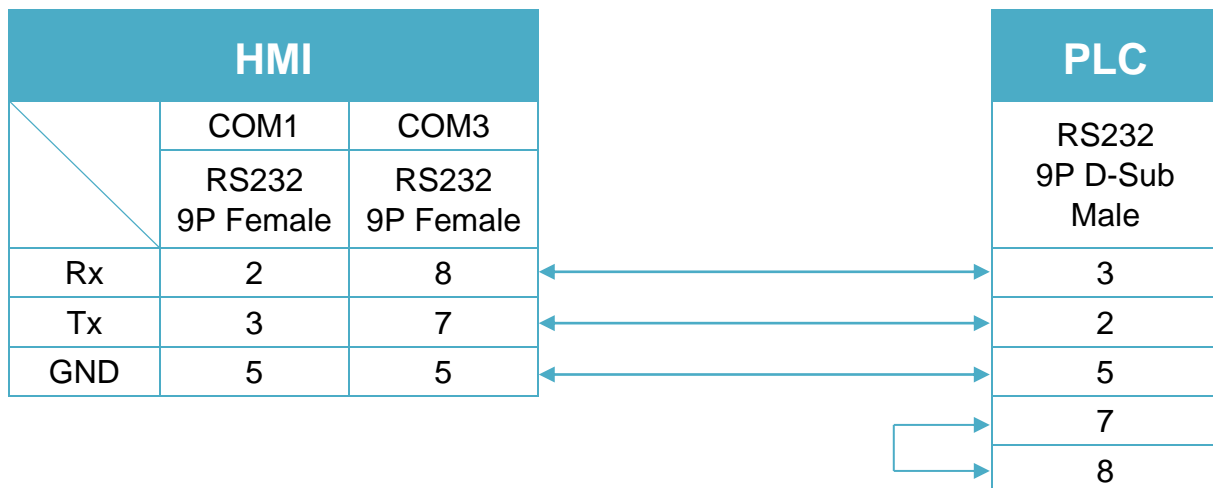


Diagram 2

cMT Series	<i>cMT-SVR</i>
mTV	<i>mTV</i>
MT-iE	<i>MT8070iE / MT6070iE / MT8100iE / MT8121iE / MT8150iE / MT8071iE / MT6071iE / MT8072iE / MT6072iE / MT8073iE / MT8101iE / MT8102iE / MT8103iE</i>
MT-XE	<i>MT8121XE / MT8150XE / MT8090XE</i>

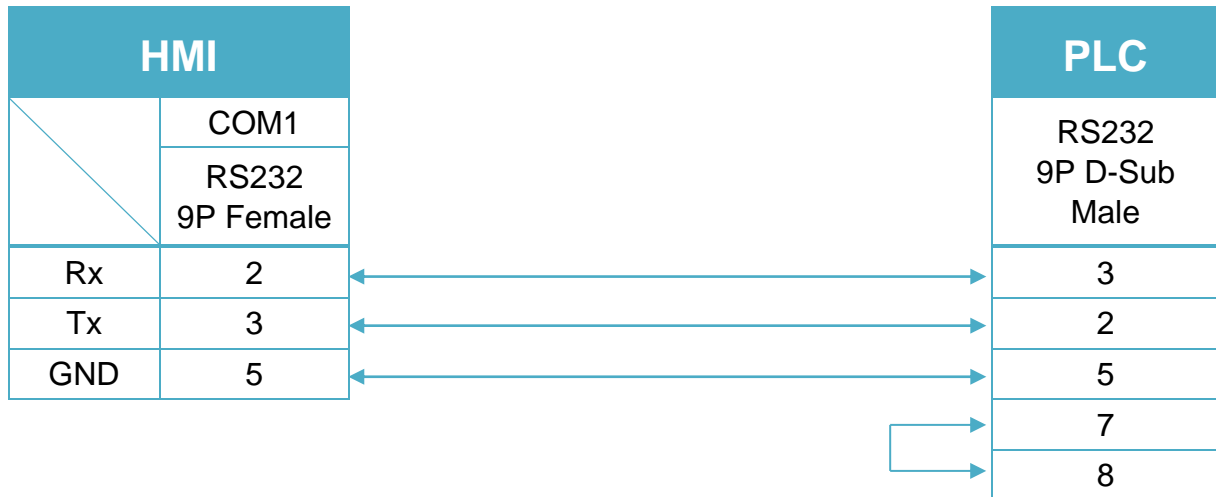
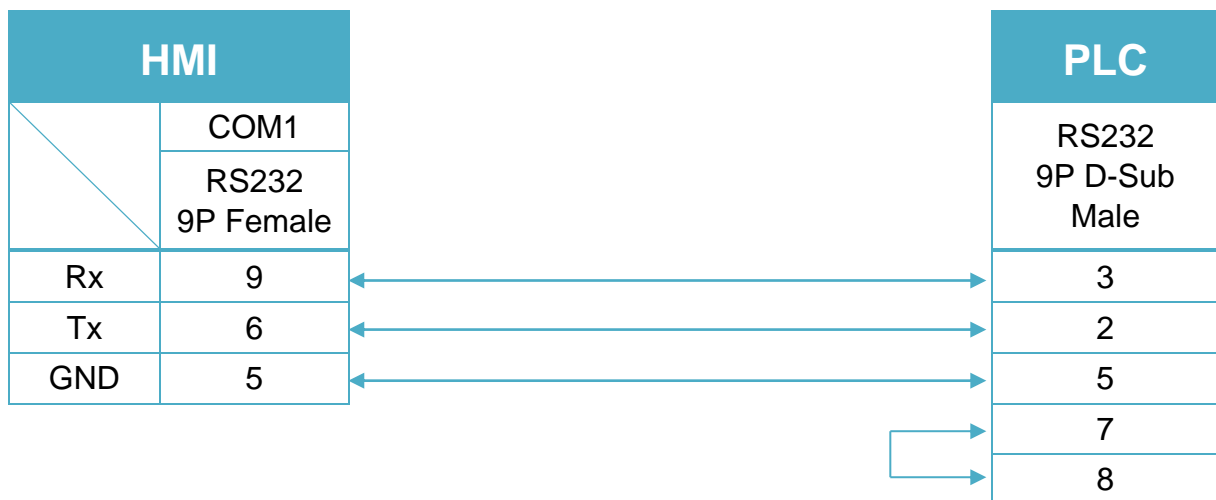


Diagram 3

MT-iE *MT8050iE*

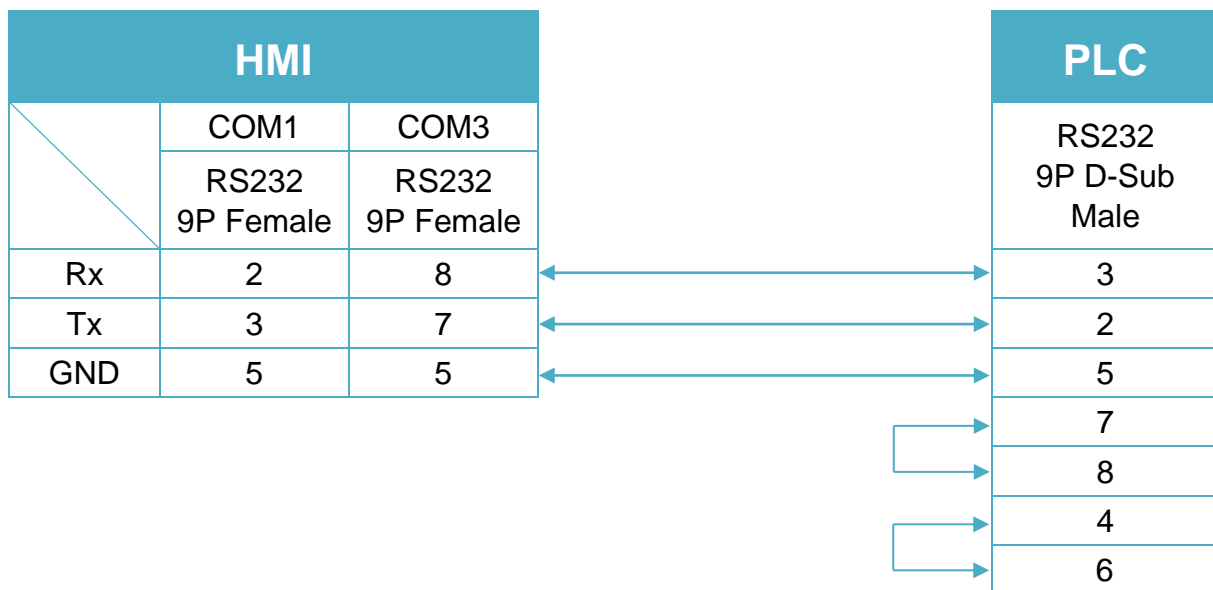
MT-iP *MT6051iP / MT6071iP / MT8071iP*



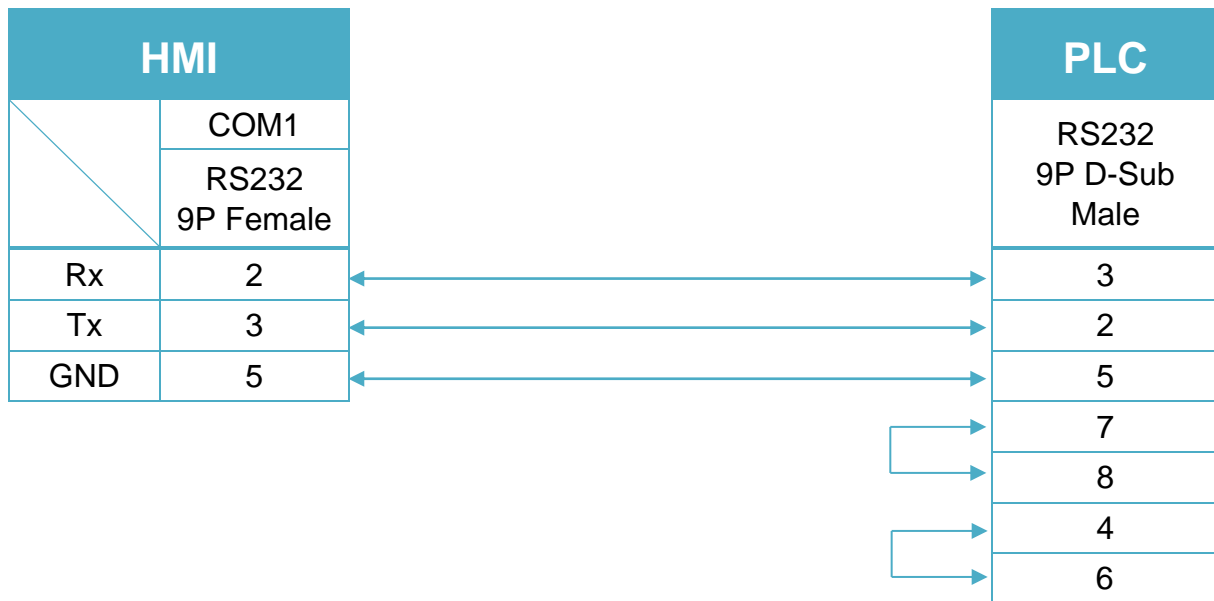
Systeme Helmholz SSW7-TS : 9P D-Sub to 9P D-Sub (Diagram 4 ~ Diagram 6)

Diagram 4

cMT Series	<i>cMT3151</i>
eMT Series	<i>eMT3070 / eMT3105 / eMT3120 / eMT3150</i>
MT-iE	<i>MT8073iE / MT8102iE</i>
MT-XE	<i>MT8092XE</i>
MT-iP	<i>MT6103iP</i>

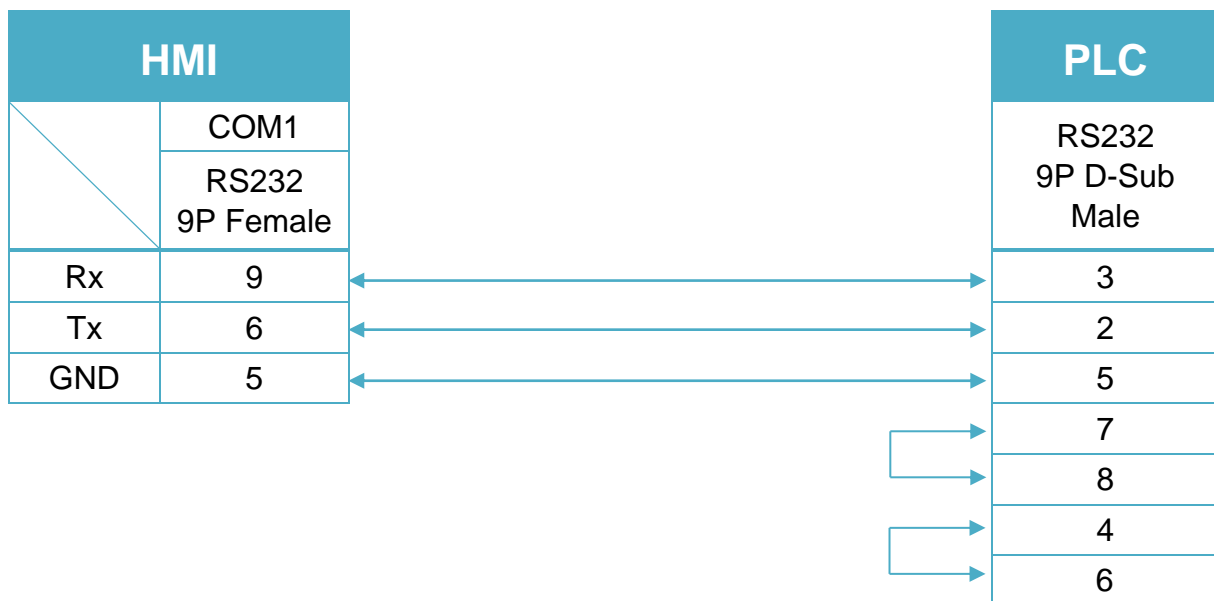

Diagram 5

cMT Series	<i>cMT-SVR</i>
mTV	<i>mTV</i>
MT-iE	<i>MT8070iE / MT6070iE / MT8100iE / MT8121iE / MT8150iE / MT8071iE / MT6071iE / MT8072iE / MT6072iE / MT8073iE / MT8101iE / MT8102iE / MT8103iE</i>
MT-XE	<i>MT8121XE / MT8150XE / MT8090XE</i>


Diagram 6

MT-iE *MT8050iE*

MT-iP *MT6051iP / MT6071iP / MT8071iP*



Siemens S7-300/S7-400 (ISO Ethernet)

Supported Series: Siemens S7-300 Ethernet Series PLC, Ethernet module CP-343-1, CPU315-2 PN/DP, CPU317-2 PN/DP, CPU319-3 PN/DP, ET200S, CP-443-1.

Website: <http://www.siemens.com/entry/cc/en/>

HMI Setting:

Parameters	Recommended	Options	Notes
PLC type	Siemens S7-300/S7-400 (ISO Ethernet)		
PLC I/F	Ethernet		
Local TSAP	100		
Remote TSAP	103		

Online simulator	No
-------------------------	----

IP Address Settings

MAC : 08 : 00 : 06 : 95 : 7F : 72

Accessible Nodes...

Timeout (sec) : 1.0 v Turn around delay (ms) : 0

Local TSAP (HEX) : 100 Remote TSAP (HEX) : 103

The number of resending commands : 0 v

Device Address:

Bit/Word	Device type	Format	Range	Memo
B	I	DDDDo	0 ~ 40957	Input (I)
B	Q	DDDDo	0 ~ 40957	Output (O)
B	M	DDDDo	0 ~ 40957	Bit Memory
B	DBnBit	FFFFFFDDDDo	0 ~ 655359997	
B	DBxBit	FFFFFFDDDDDo	0 ~ 10700655327	
B	DB0Bit-DB99Bit	DDDDDo	0 ~ 655327	Data Register Bit
W	IW	DDDD	0 ~ 4095	Input (I)
W	QW	DDDD	0 ~ 4095	Output (O)
Byte	MB	DDDD	0 ~ 4095	Bit Memory Byte
W	MW	DDDD	0 ~ 4095	Bit Memory
DW	MD	DDDD	0 ~ 4094	Bit Memory Double Word
DW	MD_Anyaddr	DDDD	0 ~ 4094	Bit Memory Double Word (must be even)
Byte	DBBn	FFFFFFDDDD	0 ~ 655359999	Data Register Byte
Byte	DBBx	FFFFFFDDDD	0 ~ 1070065532	
W	DBn	FFFFFFDDDD	0 ~ 655359999	Data Register(must be even)
W	DBx	FFFFFFDDDD	0 ~ 1070065532	
DW	DBDn	FFFFFFDDDD	0 ~ 655359999	Data Register Double Word (must be even)
DW	DBDx	FFFFFFDDDD	0 ~ 1070065532	
DW	DBDn_Anyaddr	FFFFFFDDDD	0 ~ 655359999	Data Register Double Word (must be even)
W	DBn_String	FFFFFFDDDD	0 ~ 655359999	
W	DBx_String	FFFFFFDDDD	0 ~ 1070065532	
W	DBn_String1	FFFFFFDDDD	0 ~ 655359999	
W	DBx_String1	FFFFFFDDDD	0 ~ 1070065532	
DW	DBDn_String	FFFFFFDDDD	0 ~ 655359999	
DW	DBDx_String	FFFFFFDDDD	0 ~ 1070065532	
W	DB0 ~ DB99	DDDD	0 ~ 65532	Data Register(must be even)

- Double word and floating point value must use DBDn device type.

Wiring Diagram:

Ethernet cable:



Siemens S7-300 MPI

Supported Series: Siemens S7-300 series PLC

Website: <http://www.siemens.com/entry/cc/en/>

HMI Setting:

Parameters	Recommend	Options	Notes
PLC type	SIEMENS S7-300 MPI		
PLC I/F	RS-485 2W		
Baud rate	187.5K	19200,187.5K	
Data bits	8		
Parity	Even		
Stop bits	1		
PLC sta. no.	2	2 ~ 31	

Online simulator	NO	Extend address mode	Yes
Broadcast command	NO		

Device Address:

Bit/Word	Device type	Format	Range	Memo
B	I	DDDDo	0 ~ 40957	Input (I)
B	Q	DDDDo	0 ~ 40957	Output (O)
B	M	DDDDo	0 ~ 40957	Bit Memory
B	DBnBit	FFFFFFDDDDo	0 ~ 655359997	Data Register Bit
B	DBxBit	FFFFFFDDDDo	0 ~ 10700655327	
B	DB1Bit ~ DB99Bit	DDDDDo	0 ~ 655327	Data Register Bit
W	IW	DDDD	0 ~ 4095	Input (I)
W	QW	DDDD	0 ~ 4095	Output (O)
Byte	MB	DDDD	0 ~ 4095	Bit Memory Byte
W	MW	DDDD	0 ~ 4095	Bit Memory
DW	MD	DDDD	0 ~ 4094	
Byte	DBBn	FFFFFFDDDD	0 ~ 655359999	Data Register
Byte	DBBx	FFFFFFDDDD	0 ~ 1070065532	
W	DBn	FFFFFFDDDD	0 ~ 655359999	Data Register (must be even)

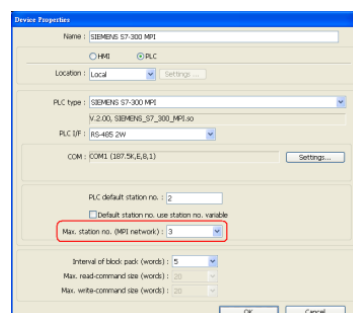
Bit/Word	Device type	Format	Range	Memo
W	DBx	FFFFFFDDDD	0 ~ 1070065532	
DW	DBDn	FFFFFFDDDD	0 ~ 655359999	Data Register Double Word (must be even)
DW	DBDx	FFFFFFDDDD	0 ~ 1070065532	
W	DBn_String	FFFFFFDDDD	0 ~ 655359999	
W	DBx_String	FFFFFFDDDD	0 ~ 1070065532	
W	DBn_String1	FFFFFFDDDD	0 ~ 655359999	
W	DBx_String1	FFFFFFDDDD	0 ~ 1070065532	
DW	DBDn_String	FFFFFFDDDD	0 ~ 655359999	
DW	DBDx_String	FFFFFFDDDD	0 ~ 1070065532	
W	DB1 ~ DB99	DDDD	0 ~ 65532	Data Register (must be even)

- Double word and floating point value must use DBDn device type.

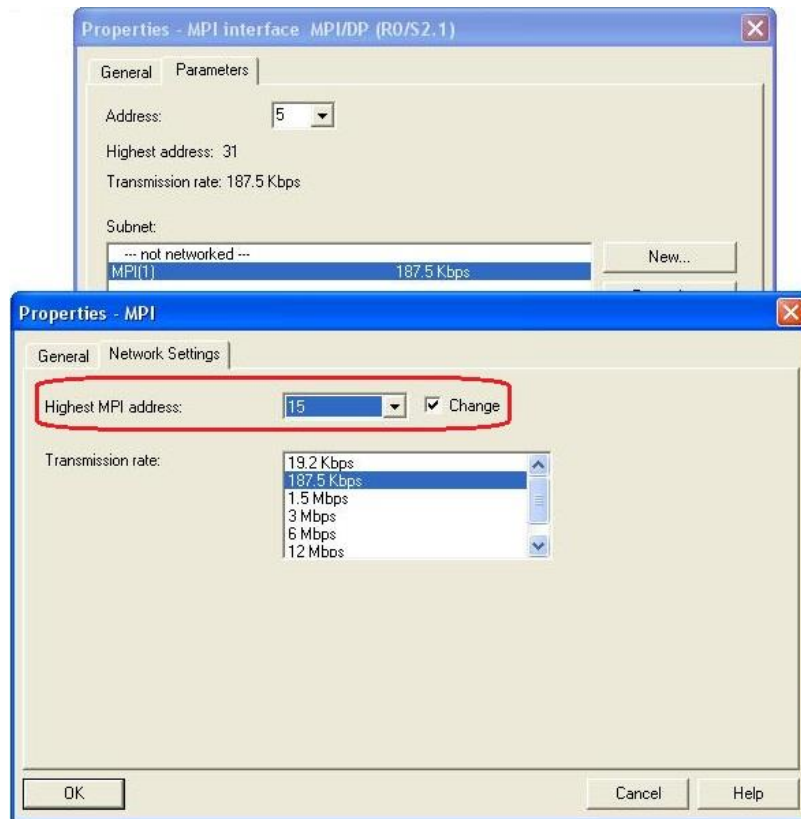
Multi-HMIs-Multi-PLCs Communication Setting:



For SIEMENS S7-300 MPI driver in Multi-HMIs-Multi-PLCs communication, [Max. station no. (MPI network)] parameter must be correctly set. This setting is relevant to the station no. of the devices, as shown, two HMI (station no. 0, 1) and two PLC (station no. 2, 3) are in MPI network, Max. Station No. should be set to 3.



For the effectiveness of communication, users may set PLC device in STEP 7 as shown below. In Properties MPI / Network Settings, set Highest MPI address to the number closest to the actual device station number.



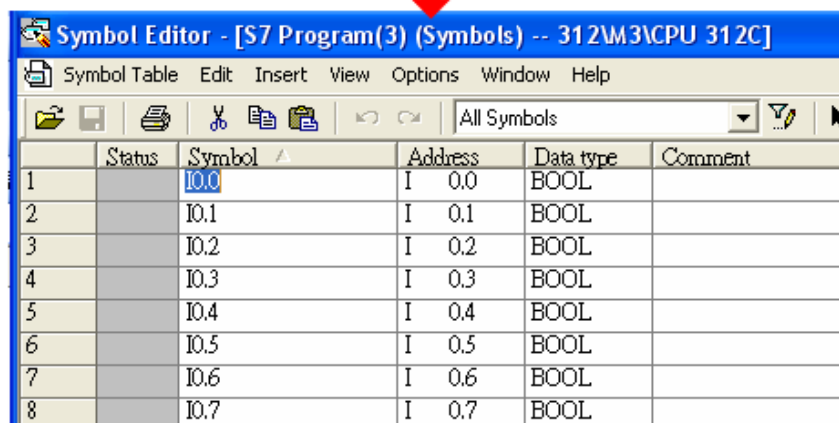
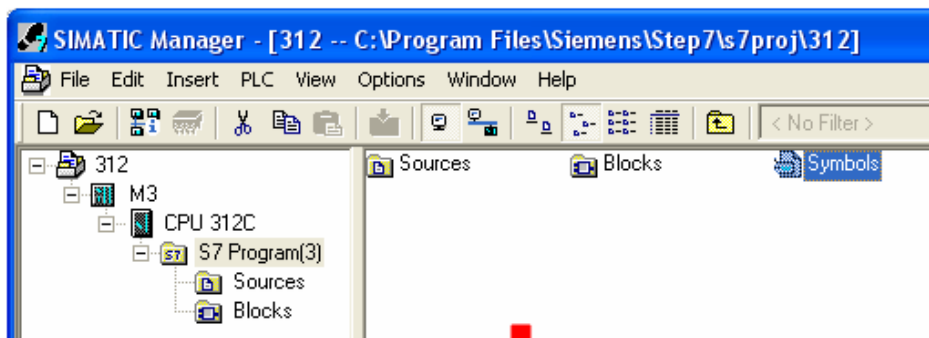
- HMI sta. no. can not be the same as PLC sta. no.
- Highly recommended that the device station numbers start from 0 sequentially and correctly set [Max. station no. (MPI network)].
- Available for EasyBuilder V4.50 and later.
- X Series does not support multiple-HMI-to-multiple-PLC communication, and supports only 1-HMI-to-1-PLC communication.

How to Import Tag:

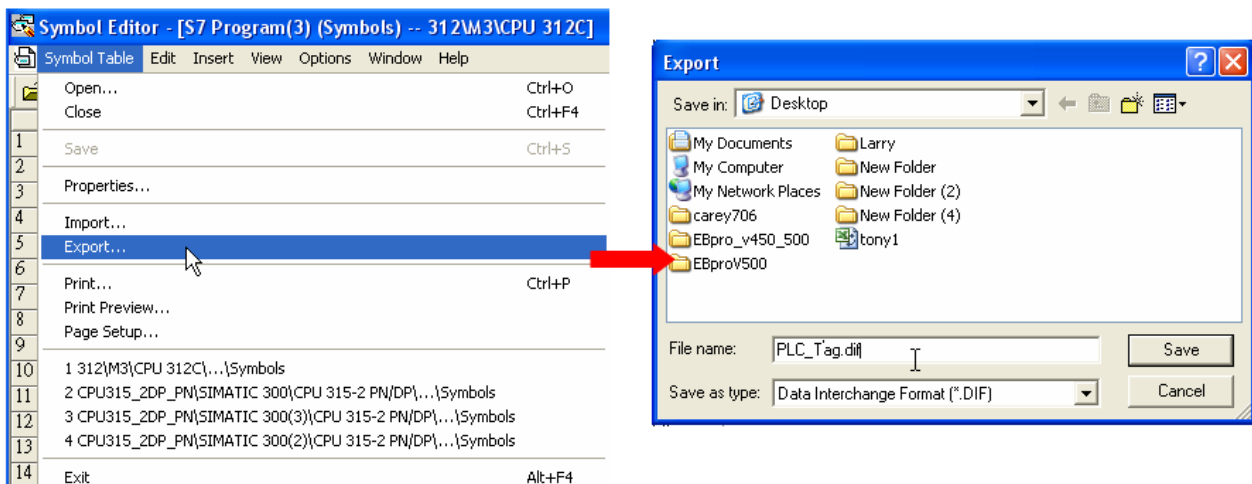
SIEMENS STEP 7 program allows building files of user-defined tag (*.dif file and *.AWL file), and import these files in EasyBuilder8000/EasyBuilderPro -> System Parameter Settings. The following describes how to build and import these two types of files.

1. Building *.dif File

- a. In "Symbols" create user-defined tag.

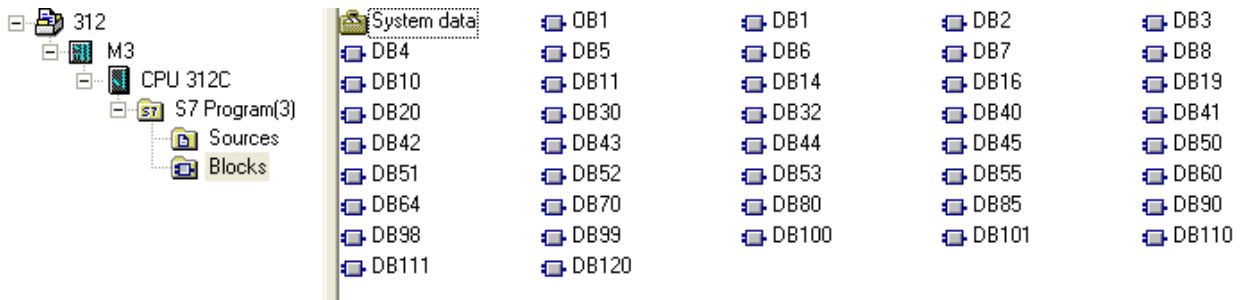


- b. Click **Export** to export the edited file and click **Save**.

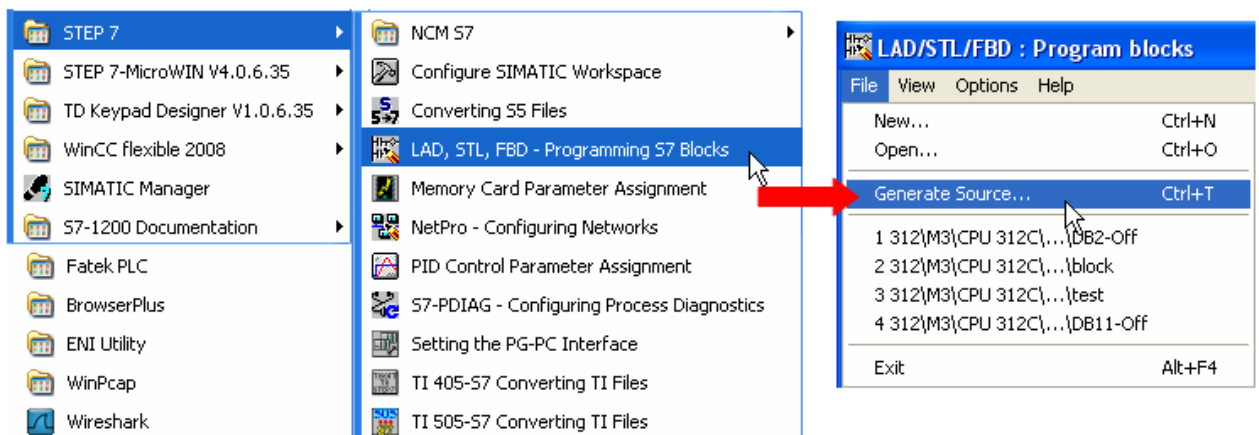


2. Building *.AWF File

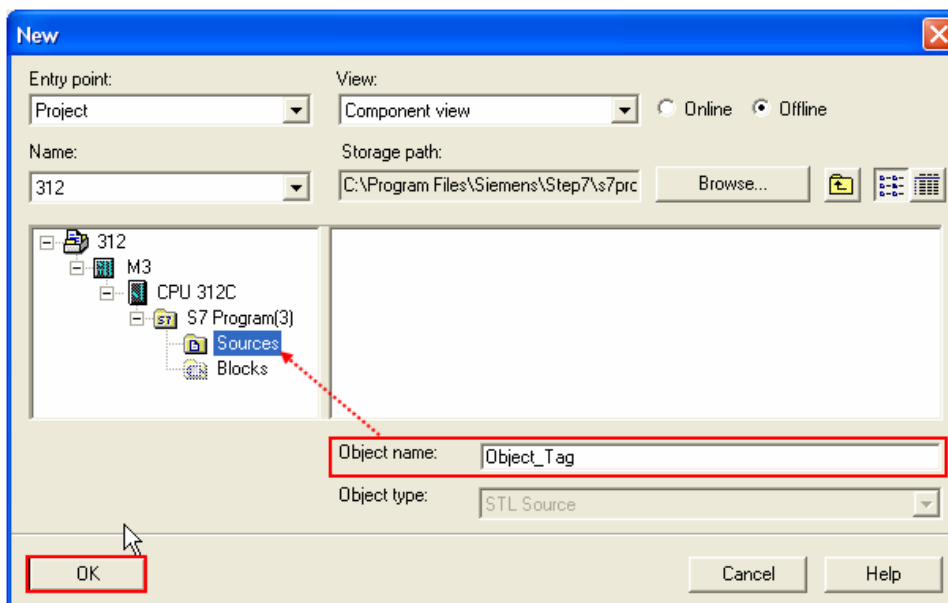
a. In **Blocks** create items as shown below:



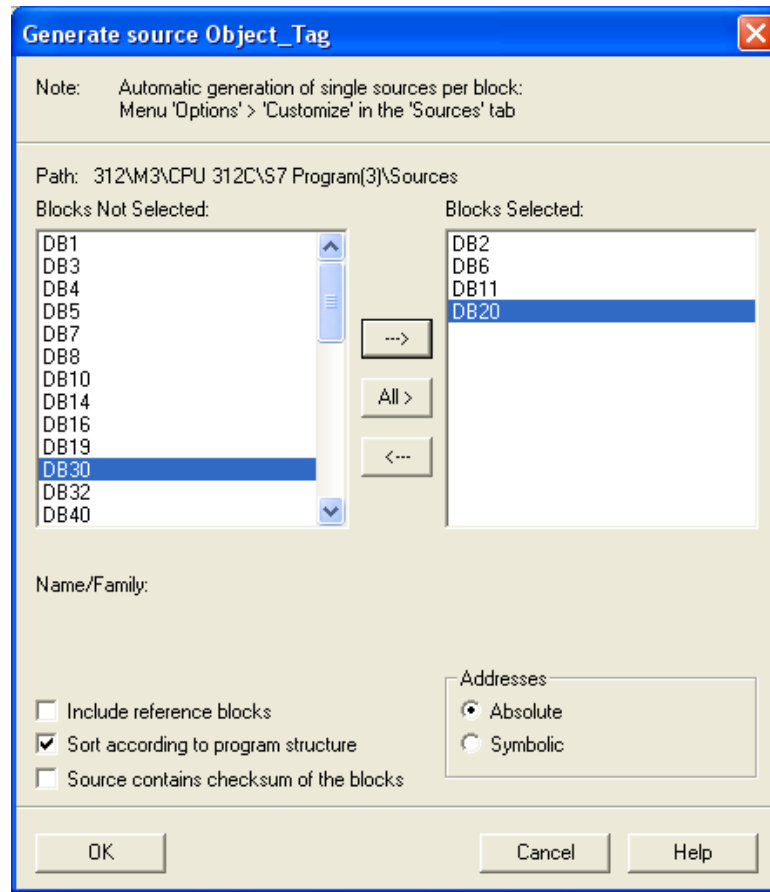
b. Open **LAD/STL, FBD – Programming S7 Blocks**, click **File -> Generate Source**.



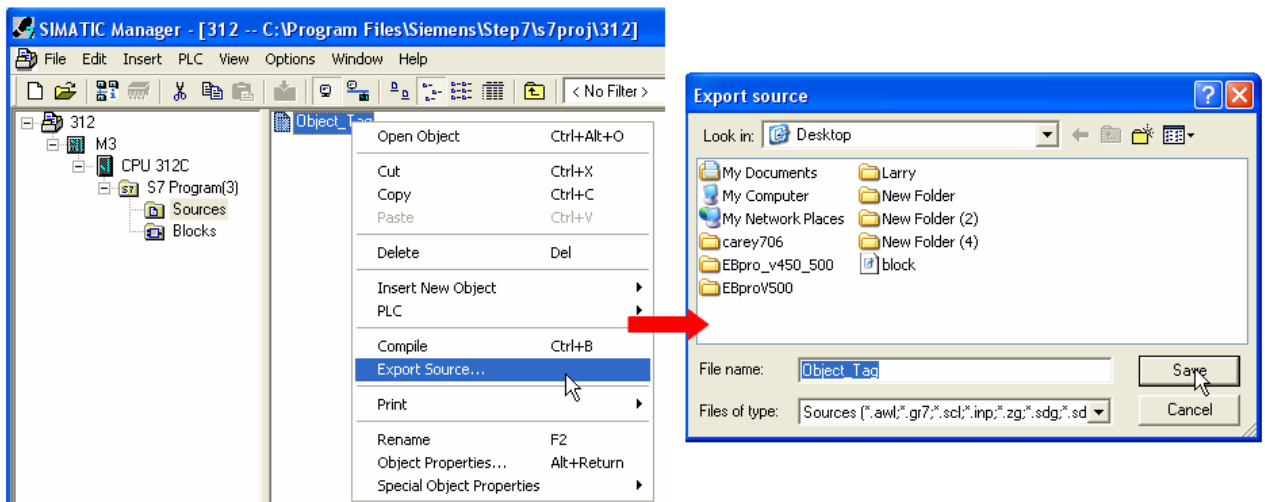
c. Select **Sources** as storage path, specify the file name then click **OK**.



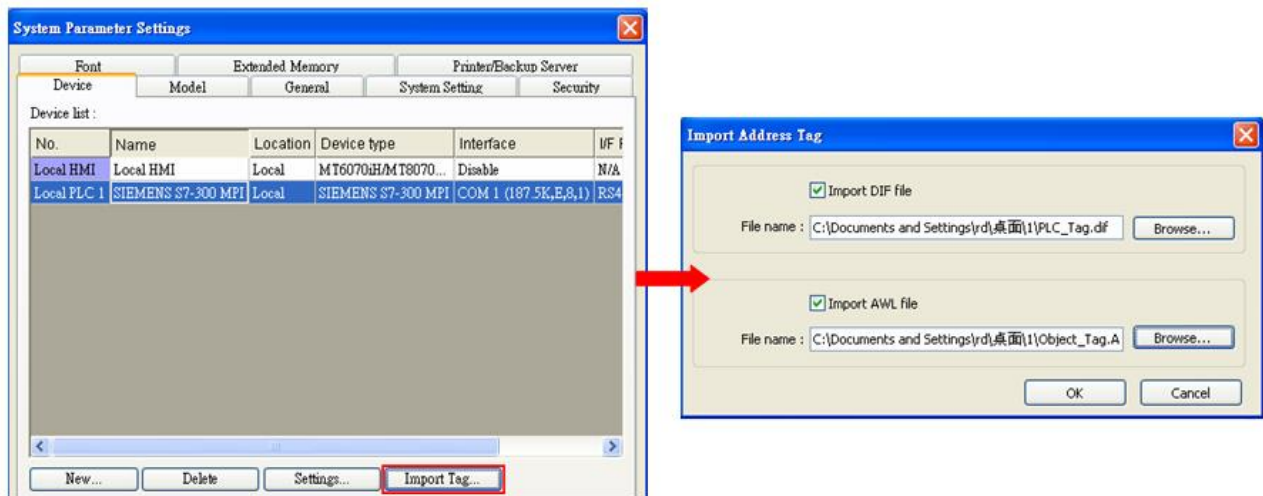
- d. Select the objects to be exported then click **OK**.



- e. Under **Sources** there will be names of the saved files, select **Export Source** to build *.AWL file.



The generated *.dif and *.AWL files can be imported in EasyBuilder8000/EasyBuilderPro **System Parameter Settings**, by clicking **Import Tag**.

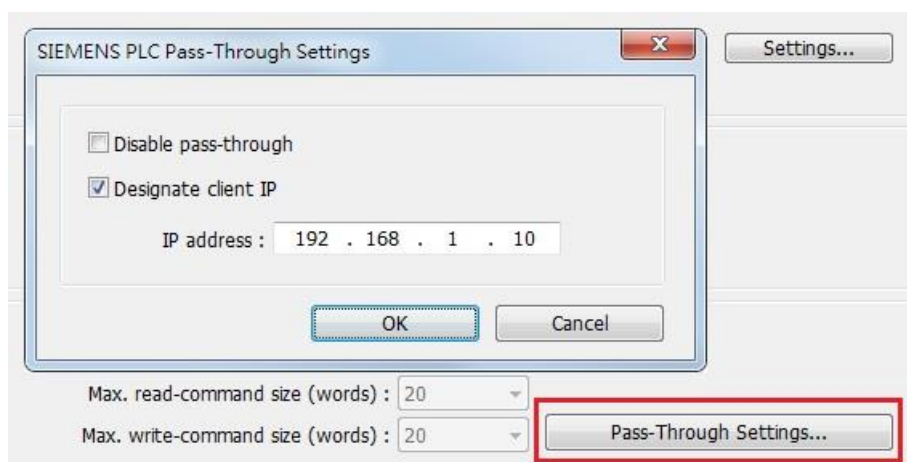


Tag information successfully imported.



Pass-Through Settings:

[Designate client IP]: In Pass-through mode designate the client IP address to connect HMI. The “client” usually refers to Siemens Step 7 application.



The following lists the system registers relevant to Siemens S7-200 PPI and Siemens S7-300 MPI Pass-through feature.

- [LW-10850: disable/enable (0 : disable, 1 : normal, 2 : IP limited) (siemens pass-through)]
- [LW-10851: destination COM port (siemens pass-through)]: Generally refers to the COM port connected with PLC.
- [LW-10852: destination PLC station no. (siemens pass-through)]
- [LW-10853: communication protocol (0 : invalid, 1 : PPI, 2 : MPI) (siemens pass-through)]
- [LW-10854 to LW-10857: IP of connecting client (siemens pass-through)]: Displays current client IP address connected with HMI.
- [LW-10858 to LW-10861: IP of designated client (siemens pass-through)]: If LW-10850 is set to 1, the system registers can be used to designate the client IP connected with HMI.
- [LW-10862: connection status (0 : ready, 1 : client connecting) (siemens pass-through)]
- [LW-10863: execution status (0 : normal, 1 : error) (siemens pass-through)]
- [LW-10864: the last error (siemens pass-through)]

The following table lists the error codes, the description of each code, and the possible reason.

Error Code	Description	Possible Reason
0	Successfully executed	
1	Prohibit client from connecting HMI	HMI is already running pass-through and won't accept any request from other client.
2	Prohibit client from connecting HMI	When LW-10850 is set to 1, the client IP for connecting HMI is different from the IP specified in LW-10858 ~ LW-10861.
3	Invalid communication protocol	Invalid setting in LW-10853.
4	Invalid PLC station number	The PLC station number specified in LW-10852 does not exist.
5	Delayed communication	PLC connection failure.
6	Busy communication	PLC does not accept pass-through request, please confirm PLC settings.
7	Invalid pass-through request	Environment setup failure.

Wiring Diagram:

S7-200 PPI , S7-300 MPI :RS485 2W

Diagram 1

cMT Series *cMT3151*

eMT Series *eMT3070/ eMT3105 / eMT3120 / eMT3150*

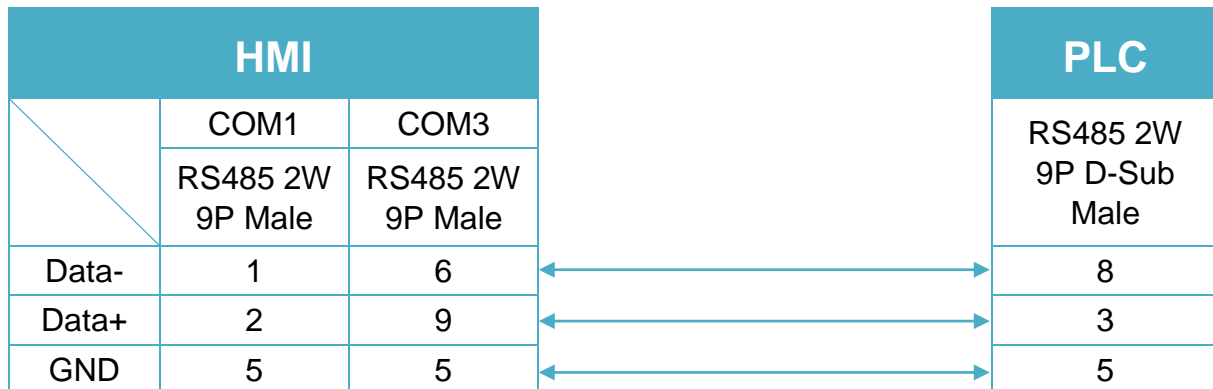


Diagram 2

cMT Series *cMT-SVR*

mTV *mTV*

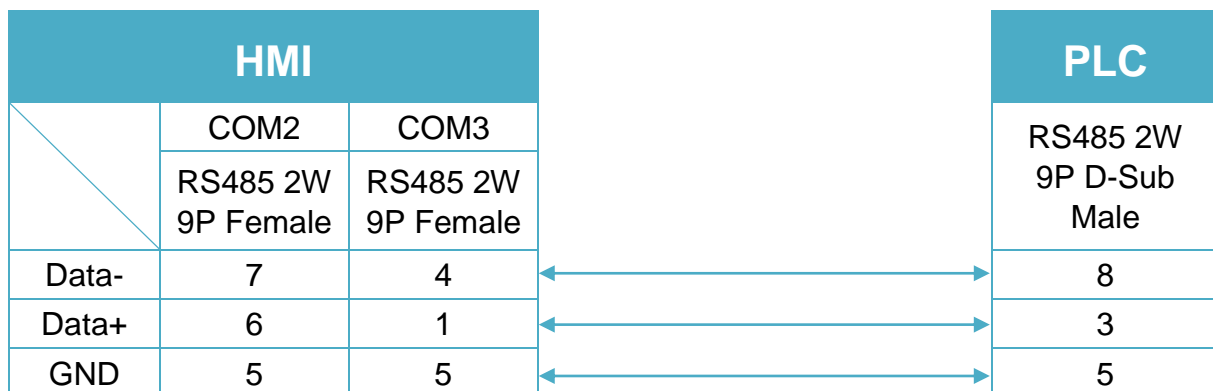


Diagram 3

MT-iE *MT8070iE / MT6070iE / MT8100iE / MT8121iE / MT8150iE*

MT-XE *MT8121XE / MT8150XE*

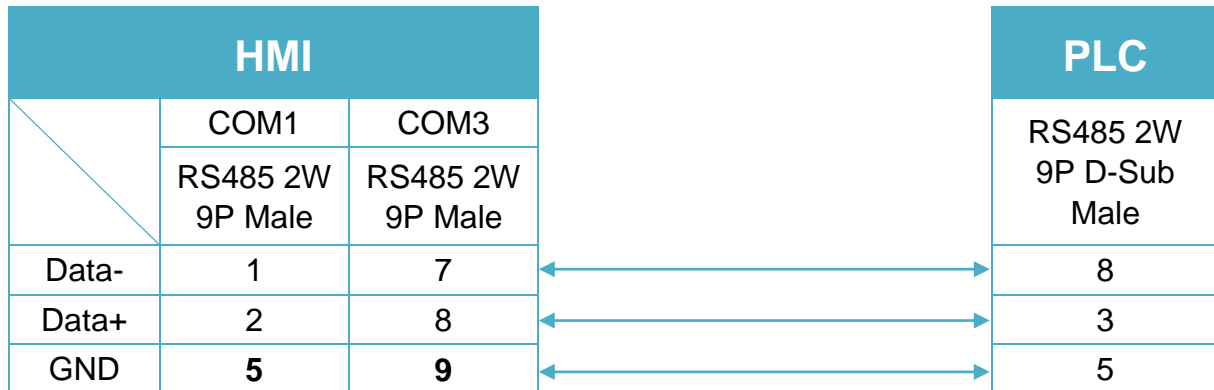


Diagram 4

MT-iE *MT8071iE / MT6071iE / MT8072iE / MT6072iE / MT8073iE /
MT8101iE / MT8102iE / MT8103iE*

MT-XE *MT8090XE / MT8092XE*

MT-iP *MT6103iP*

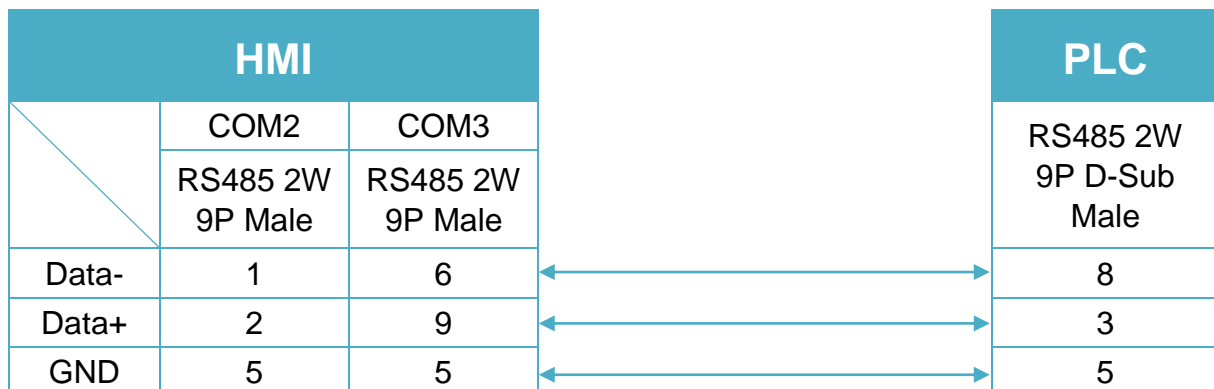


Diagram 5

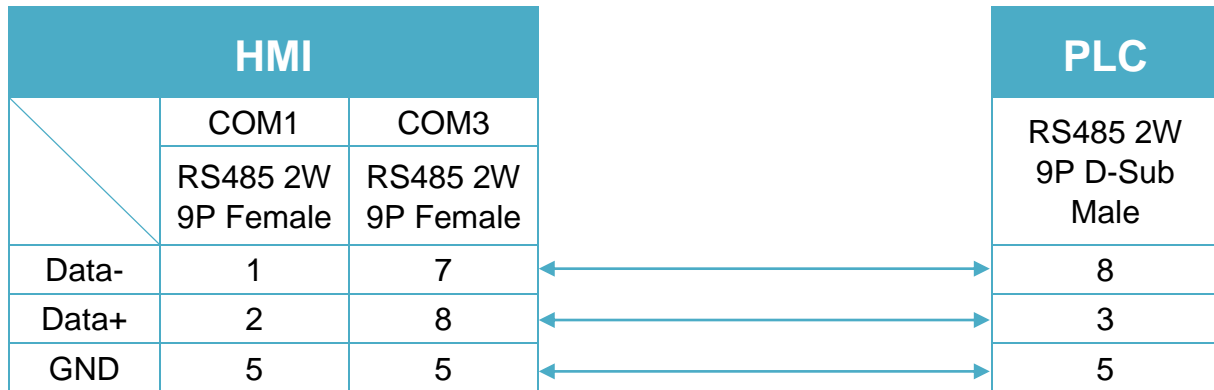
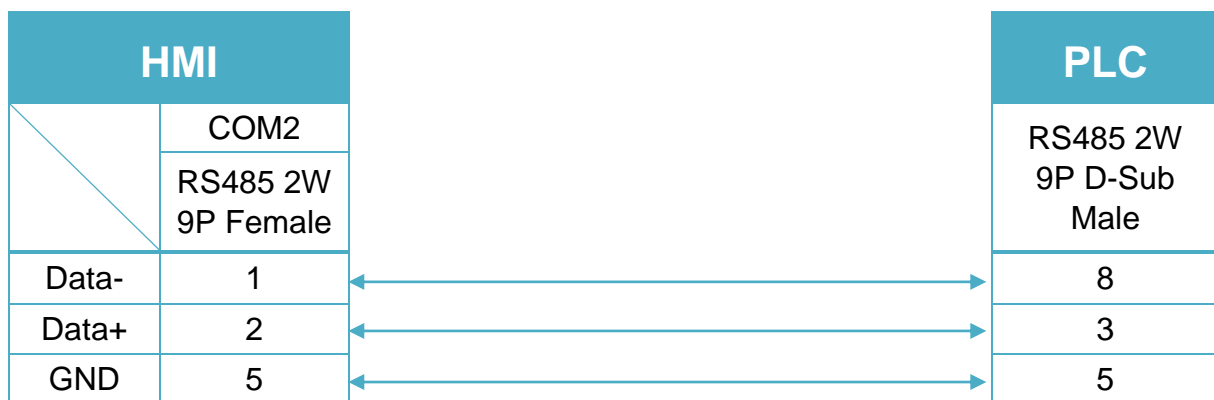
MT-iE *MT8050iE*
MT-iP *MT6051iP*


Diagram 6

MT-iP *MT6071iP / MT8071iP*


Siemens S7-300/ET200S (Ethernet)

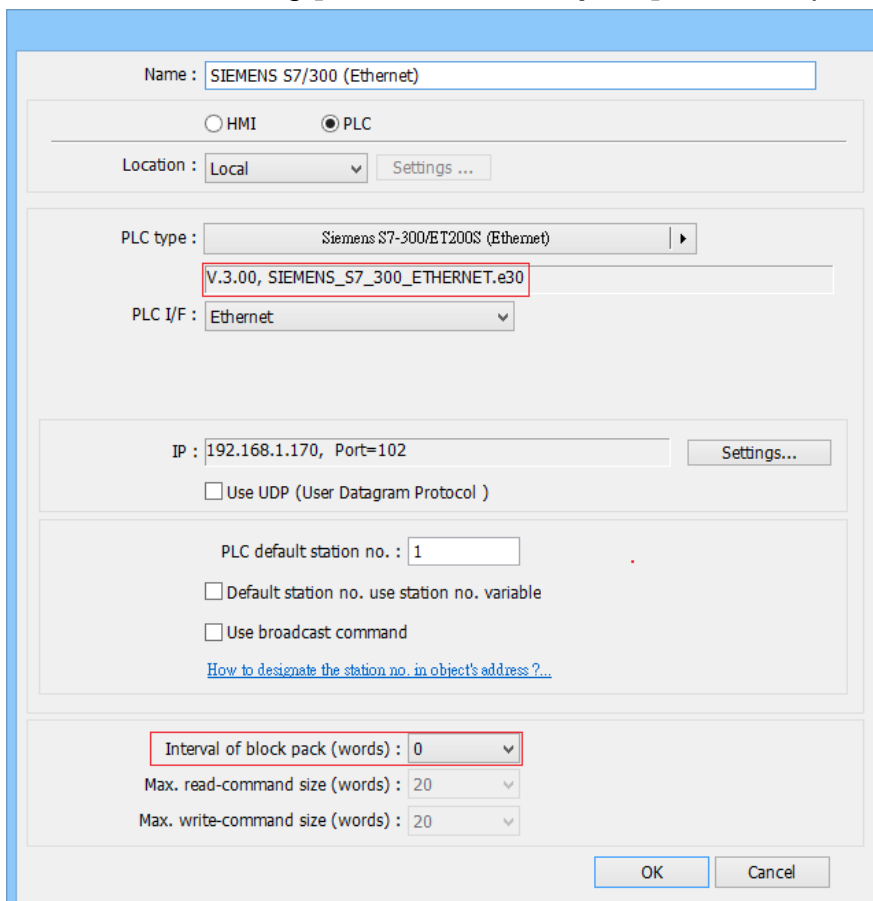
Supported Series: Siemens S7-300 Ethernet Series PLC, Ethernet module CP-343-1, CPU315-2 PN/DP, CPU317-2 PN/DP, CPU319-3 PN/DP, and ET200S.

Website: <http://www.siemens.com/entry/cc/en/>

HMI Setting:

Parameters	Recommended	Options	Notes
PLC type	SIEMENS S7-300/ET200S (Ethernet)		
PLC I/F	Ethernet		
Port no.	102		
PLC sta. no.	1	0-31	

In V3.00 and later versions, setting **[Interval of block pack]** to 0 can optimize efficiency.



The screenshot shows the configuration dialog for a Siemens S7-300/ET200S (Ethernet) PLC. The settings are as follows:

- Name: SIEMENS S7/300 (Ethernet)
- Mode: PLC
- Location: Local
- PLC type: Siemens S7-300/ET200S (Ethernet)
- PLC I/F: Ethernet
- IP: 192.168.1.170, Port=102
- Use UDP (User Datagram Protocol):
- PLC default station no.: 1
- Default station no. use station no. variable:
- Use broadcast command:
- Interval of block pack (words): 0
- Max. read-command size (words): 20
- Max. write-command size (words): 20

Device Address:

Bit/Word	Device type	Format	Range	Memo
B	I	DDDDo	0 ~ 40957	Input (I)
B	Q	DDDDo	0 ~ 40957	Output (O)
B	M	DDDDo	0 ~ 40957	Bit Memory
B	DBnBit	FFFFFFDDDDo	0 ~ 655359997	
B	DBxBit	FFFFFFDDDDDo	0 ~ 10700655327	
B	DB1Bit-DB99Bit	DDDDDo	0 ~ 655327	Data Register Bit
W	IW	DDDD	0 ~ 4095	Input (I)
W	QW	DDDD	0 ~ 4095	Output (O)
Byte	MB	DDDD	0 ~ 4095	Bit Memory Byte
W	MW	DDDD	0 ~ 4095	Bit Memory
DW	MD	DDDD	0 ~ 4094	Bit Memory Double Word
DW	MD_Anyaddr	DDDD	0 ~ 4094	Bit Memory Double Word (must be even)
Byte	DBBn	FFFFFFDDDD	0 ~ 655359999	Data Register Byte
Byte	DBBx	FFFFFFDDDD	0 ~ 1070065532	
W	DBn	FFFFFFDDDD	0 ~ 655359999	Data Register (must be even)
W	DBx	FFFFFFDDDD	0 ~ 1070065532	
DW	DBDn	FFFFFFDDDD	0 ~ 655359999	Data Register Double Word (must be even)
DW	DBDx	FFFFFFDDDD	0 ~ 1070065532	
DW	DBDn_Anyaddr	FFFFDDDD	0 ~ 40969999	Data Register Double Word (must be even)
W	DBn_String	FFFFFFDDDD	0 ~ 655359999	
W	DBx_String	FFFFFFDDDD	0 ~ 1070065532	
W	DBn_String1	FFFFFFDDDD	0 ~ 655359999	
W	DBx_String1	FFFFFFDDDD	0 ~ 1070065532	
DW	DBDn_String	FFFFFFDDDD	0 ~ 655359999	
DW	DBDx_String	FFFFFFDDDD	0 ~ 1070065532	
W	DB1 ~ DB99	DDDD	0 ~ 65532	Data Register(must be even)

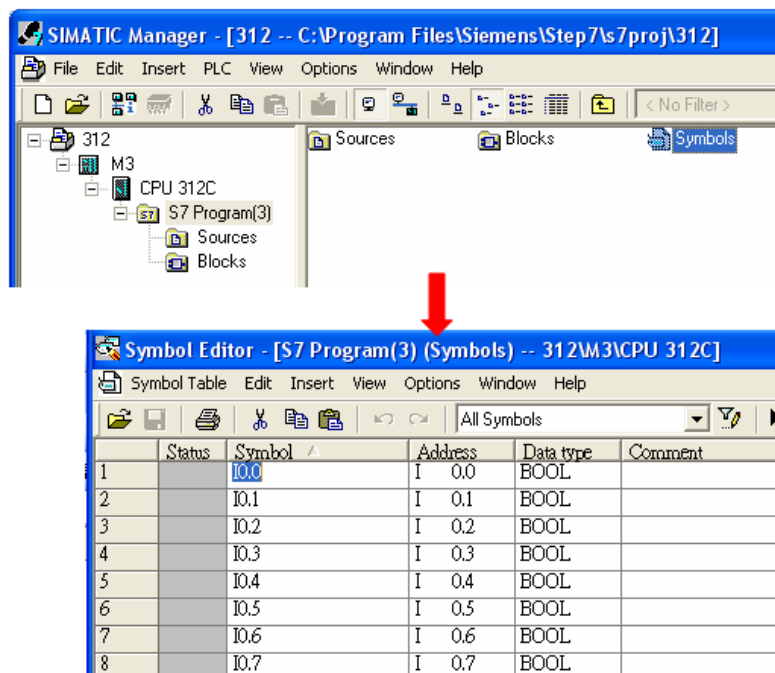
- Double word and floating point value must use DBDn device type.

How to Import Tag:

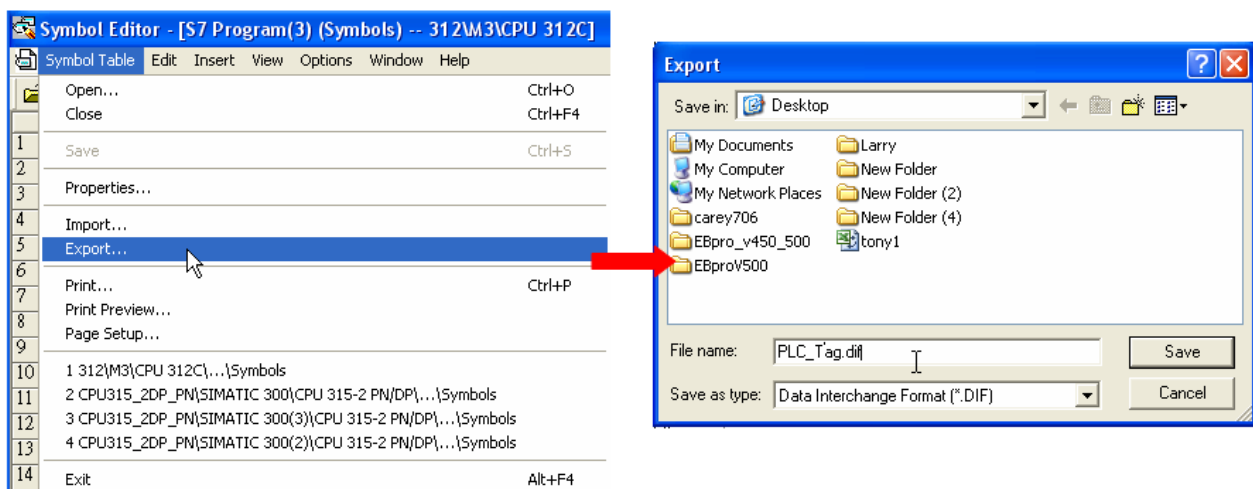
SIEMENS STEP 7 program allows building files of user-defined tag (*.dif file and *.AWL file), and import these files in EasyBuilder8000/EasyBuilderPro -> System Parameter Settings. The following describes how to build and import these two types of files.

1. Building *.dif File

- a. In “Symbols” create user-defined tag.

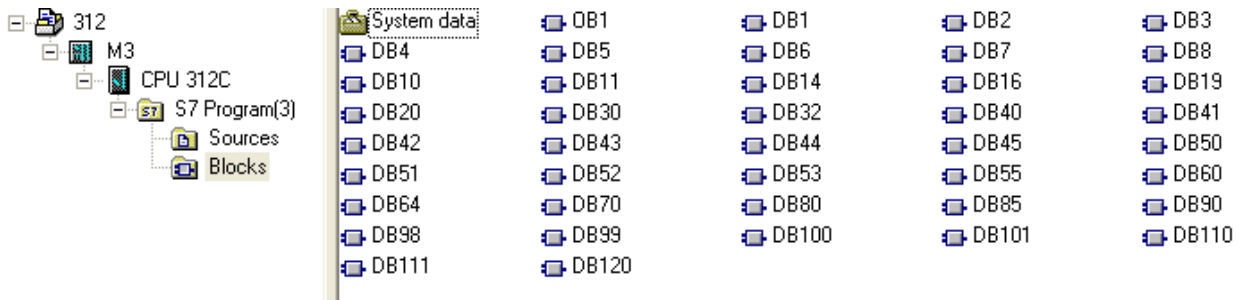


- b. Click **Export** to export the edited file and click **Save**.

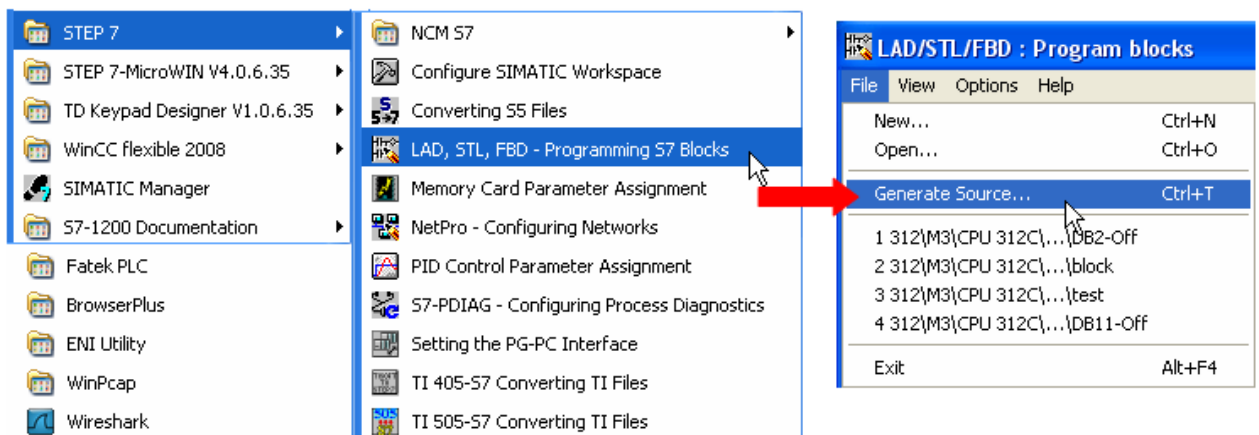


2. Building *.AWF File

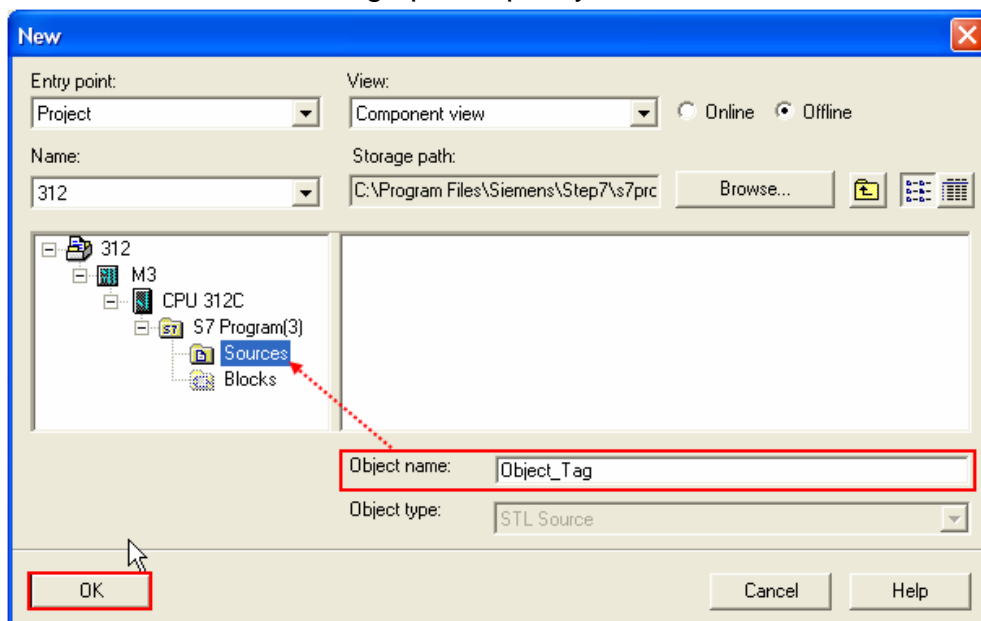
a、 In **Blocks** create items as shown below:



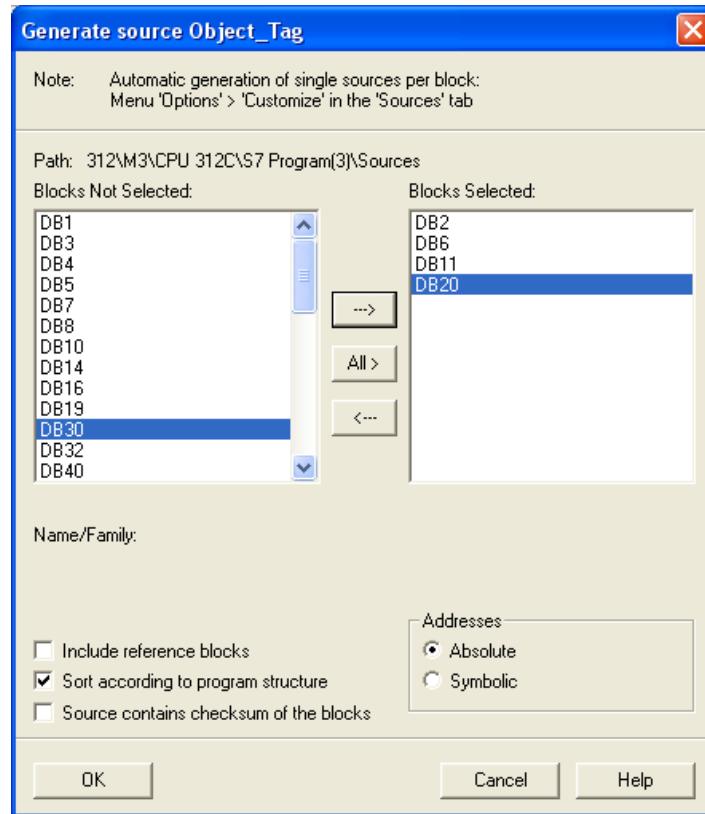
b、 Open **LAD/STL, FBD – Programming S7 Blocks**, click **File -> Generate Source**.



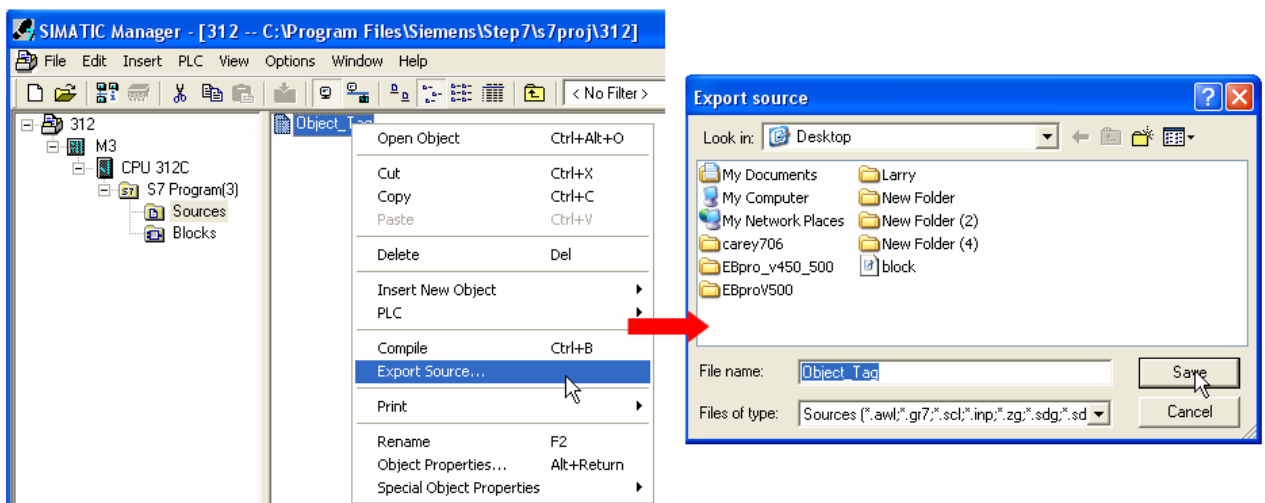
c、 Select **Sources** as storage path, specify the file name then click **OK**.



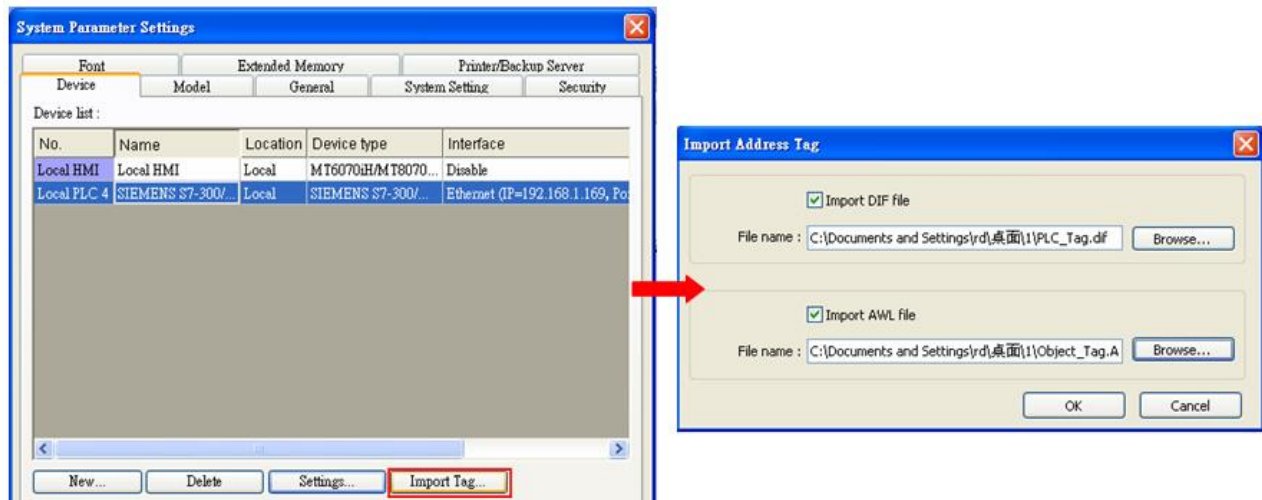
d、 Select the objects to be exported then click **OK**.



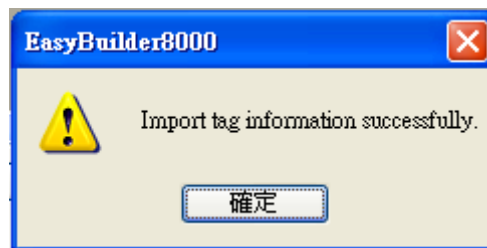
e、 Under **Sources** there will be names of the saved files, select **Export Source** to build ***.AWL** file.



The generated *.dif and *.AWL files can be imported in EasyBuilder8000/EasyBuilderPro **System Parameter Settings**, by clicking **Import Tag**.



Tag information successfully imported.



Wiring Diagram:

Ethernet cable:



Siemens S7-400 (Ethernet)

Supported Series: Siemens S7-400/1200 Ethernet PLC.

Website: <http://www.siemens.com/entry/cc/en/>

HMI Setting:

Parameters	Recommended	Options	Notes
PLC type	Siemens S7-400 (Ethernet)		
PLC I/F	Ethernet		
Port no.	102		
Link type	PG	PC, OP	
Rack	0	0-7	
CPU slot	3	1-31	To Connect with S7-1200,slot 1 must be selected.
PLC sta. no.	0	0-31	

Device Address:

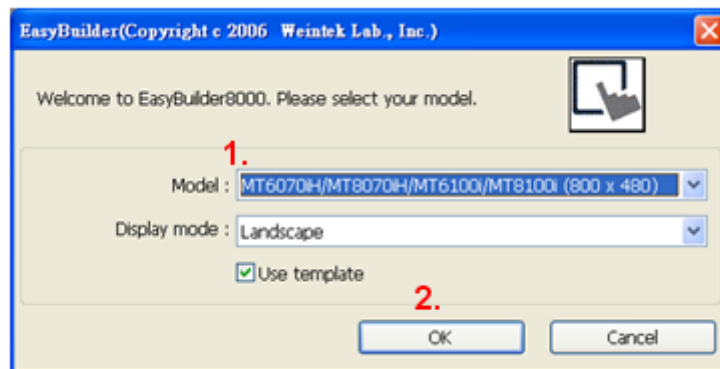
Bit/Wor	Device type	Format	Range	Memo
B	I	DDDDo	0 ~ 40957	Input (I)
B	Q	DDDDo	0 ~ 40957	Output (O)
B	M	DDDDo	0 ~ 40957	Bit Memory
B	DBnBit	FFFFFFDDDDo	0 ~ 655359997	
B	DBxBit	FFFFFFDDDDD	0 ~ 10700655327	
B	DB1Bit-DB99Bit	DDDDDo	0 ~ 655327	Data Register Bit
W	IW	DDDD	0 ~ 4095	Input (I)
W	QW	DDDD	0 ~ 4095	Output (O)
Byte	MB	DDDD	0 ~ 4095	Bit Memory Byte
W	MW	DDDD	0 ~ 4095	Bit Memory
DW	MD	DDDD	0 ~ 4094	
Byte	DBBn	FFFFFFDDDD	0 ~ 655359999	Data Register Byte
Byte	DBBx	FFFFFFDDDDD	0 ~ 1070065532	
W	DBn	FFFFFFDDDD	0 ~ 655359999	Data Register (must be even)
W	DBx	FFFFFFDDDDD	0 ~ 1070065532	
DW	DBDn	FFFFFFDDDD	0 ~ 655359999	Data Register Double Word (must be even)
DW	DBDx	FFFFFFDDDDD	0 ~ 1070065532	

Bit/Wor	Device type	Format	Range	Memo
W	DBn_String	FFFFFFDDDD	0 ~ 655359999	
W	DBx_String	FFFFFFDDDD	0 ~ 1070065532	
W	DBn_String1	FFFFDDDD	0 ~ 40969999	
W	DBx_String1	FFFFFFDDDD	0 ~ 1070065532	
DW	DBDn_String	FFFFFFDDDD	0 ~ 655359999	
DW	DBDn_String	FFFFFFDDDD	0 ~ 1070065532	
W	DB1 ~ DB99	DDDD	0 ~ 65532	Data Register (must be even)

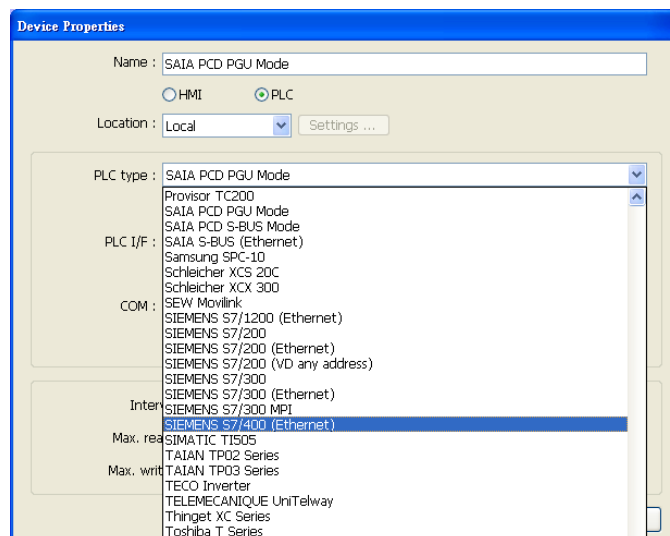
* Double word and floating point value must use DBDn device type.

EasyBuilder Device Setting Steps

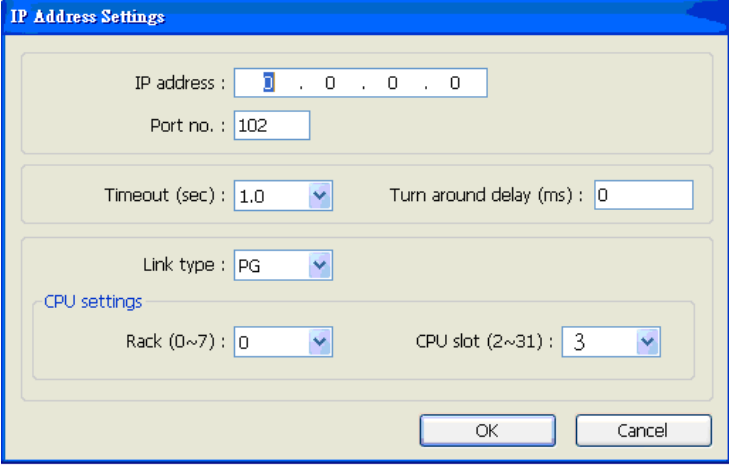
1. Open EasyBuilder, File/NEW, select HMI model and press [OK].



2. "System Parameter Settings" window is shown, click [New].
3. Select "SIEMENS S7-400(ETHERNET)".



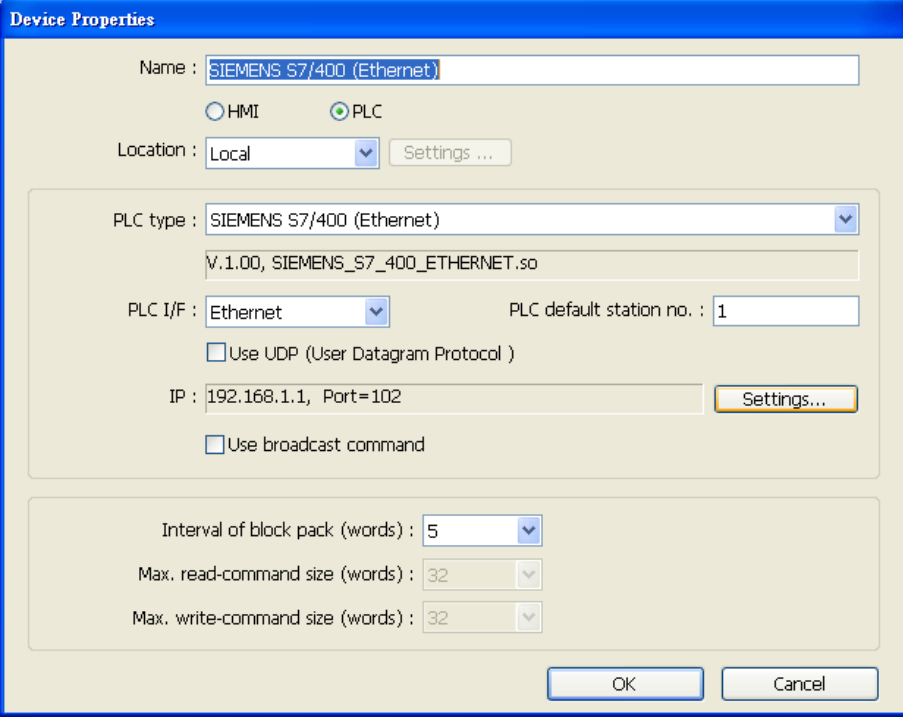
- Press [Settings].
- Set S7-400 IP, Port no., Link type, Rack and CPU slot. (must match PLC settings)



The IP Address Settings dialog box contains the following fields and controls:

- IP address: 192.168.1.1
- Port no.: 102
- Timeout (sec): 1.0
- Turn around delay (ms): 0
- Link type: PG
- CPU settings:
 - Rack (0~7): 0
 - CPU slot (2~31): 3
- Buttons: OK, Cancel

- The setting will be finished as below.



The Device Properties dialog box contains the following fields and controls:

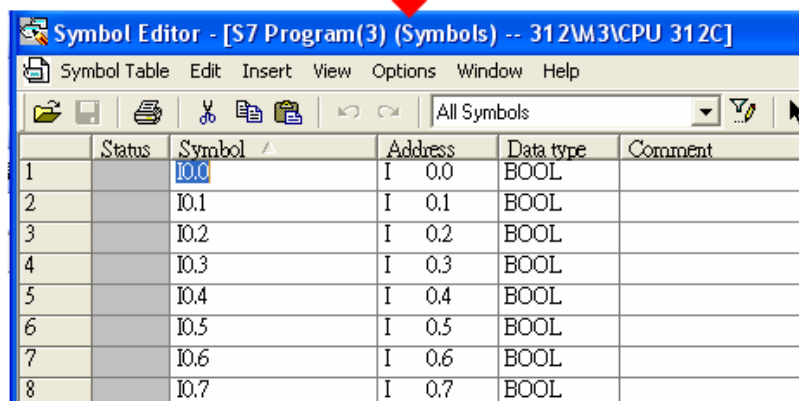
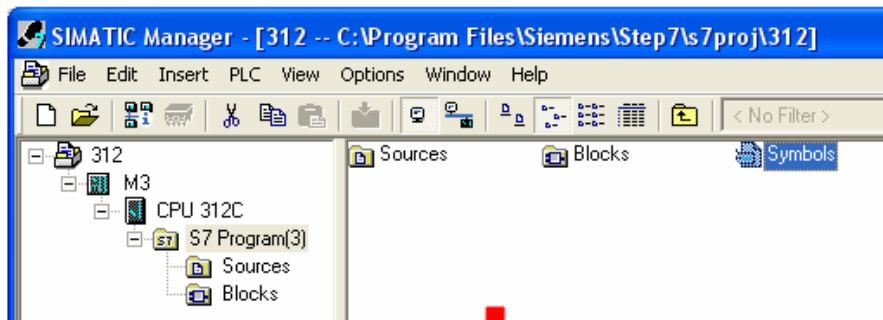
- Name: SIEMENS S7/400 (Ethernet)
- Radio buttons: HMI, PLC (selected)
- Location: Local
- Settings ... button
- PLC type: SIEMENS S7/400 (Ethernet)
- V.1.00, SIEMENS_S7_400_ETHERNET.so
- PLC I/F: Ethernet
- PLC default station no.: 1
- Use UDP (User Datagram Protocol)
- IP: 192.168.1.1, Port=102
- Settings... button
- Use broadcast command
- Interval of block pack (words): 5
- Max. read-command size (words): 32
- Max. write-command size (words): 32
- Buttons: OK, Cancel

How to Import Tag:

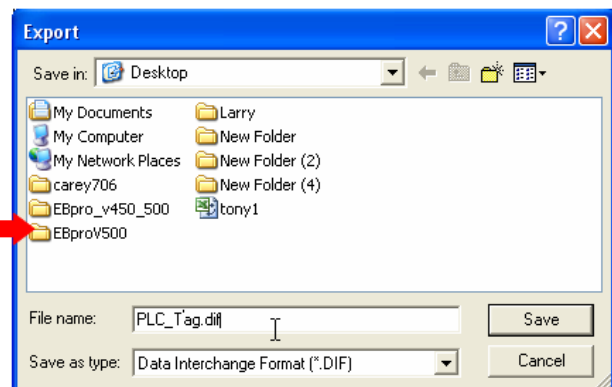
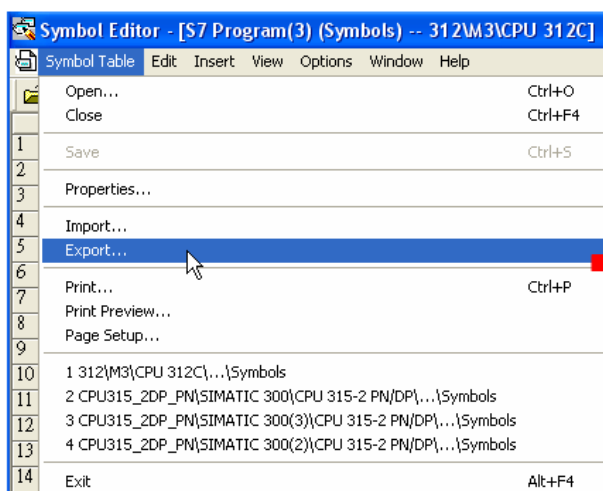
SIEMENS STEP 7 program allows building files of user-defined tag (*.dif file and *.AWL file), and import these files in EasyBuilder8000/EasyBuilderPro -> System Parameter Settings. The following describes how to build and import these two types of files.

1. Building *.dif File

a. In "Symbols" create user-defined tag.

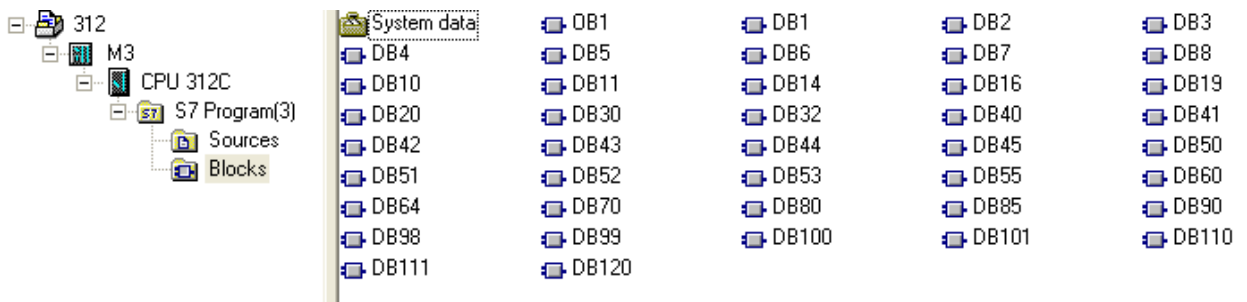


b. Click **Export** to export the edited file and click **Save**.

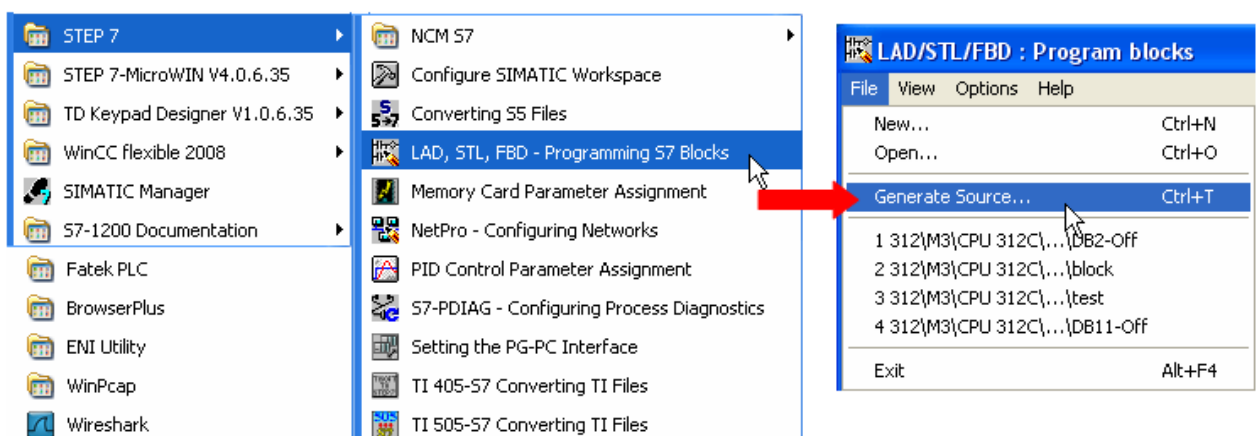


2. Building *.AWF File

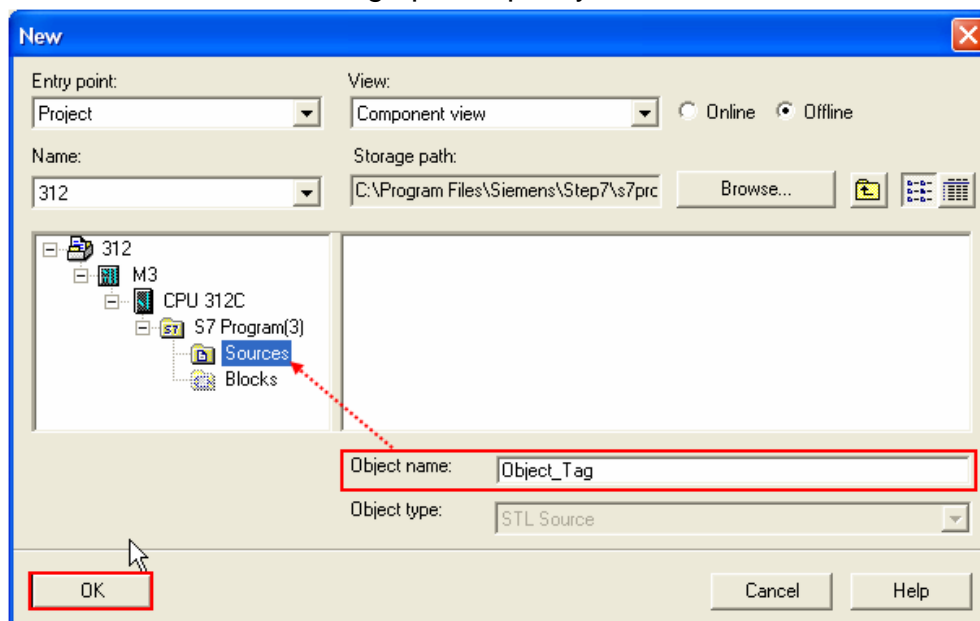
a. In **Blocks** create items as shown below:



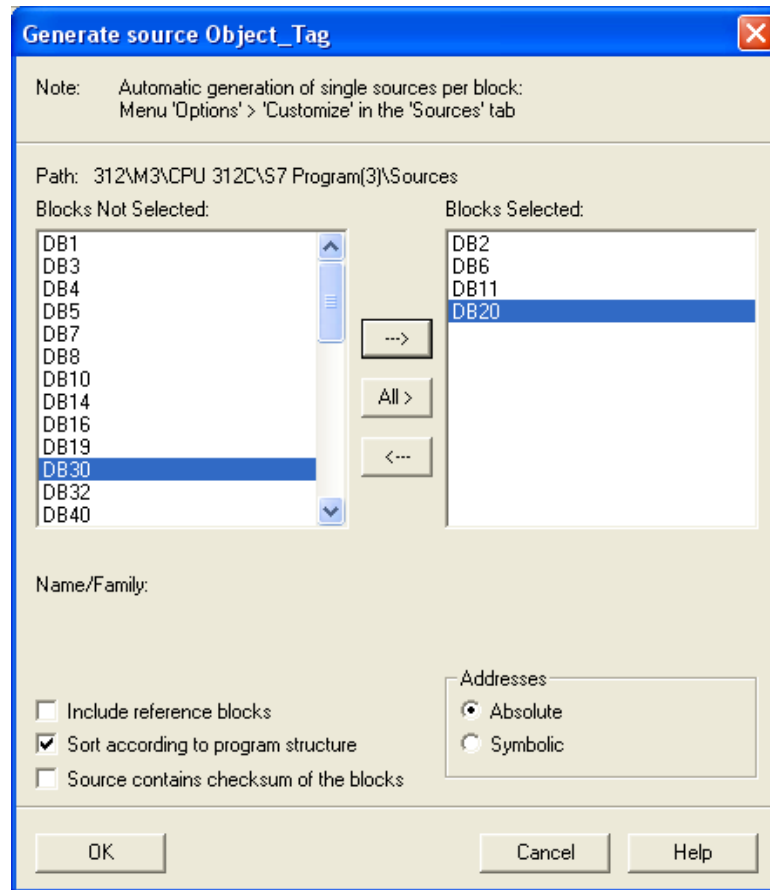
b. Open **LAD/STL, FBD – Programming S7 Blocks**, click **File -> Generate Source**.



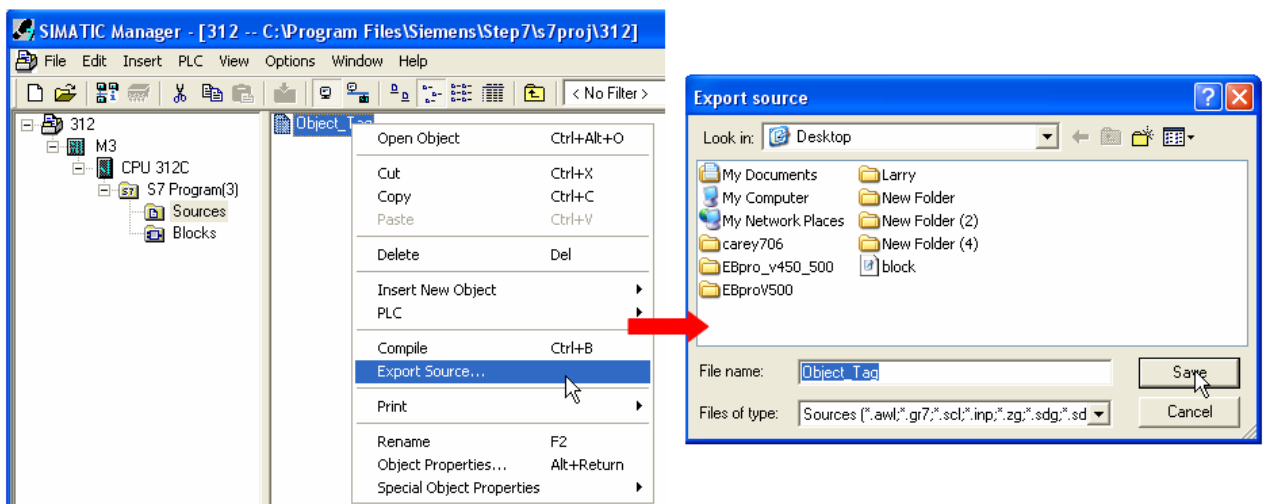
c. Select **Sources** as storage path, specify the file name then click **OK**.



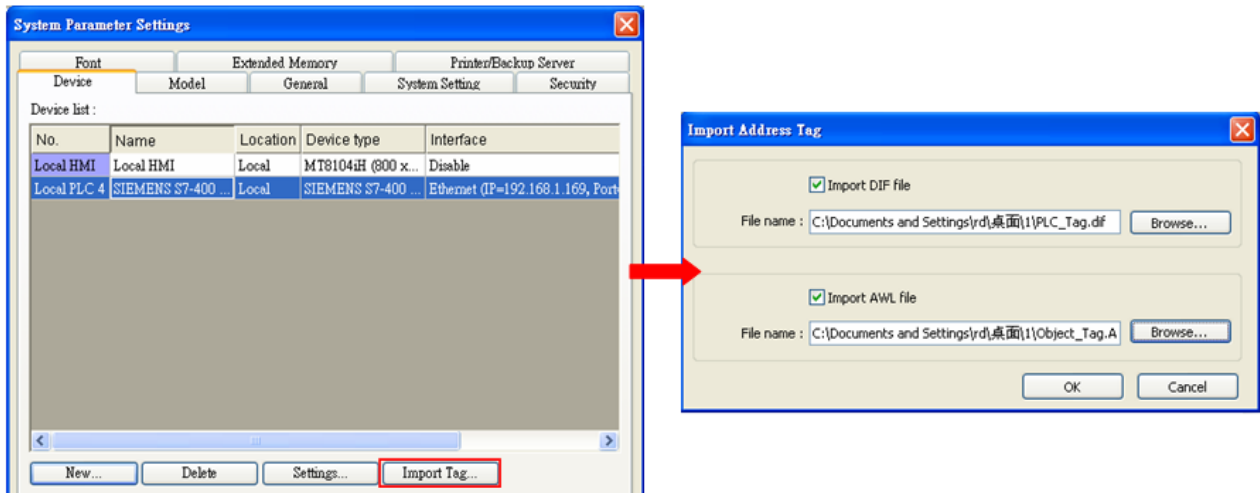
- d. Select the objects to be exported then click **OK**.



- e. Under **Sources** there will be names of the saved files, select **Export Source** to build *.AWL file.



The generated *.dif and *.AWL files can be imported in EasyBuilder8000/EasyBuilderPro **System Parameter Settings**, by clicking **Import Tag**.

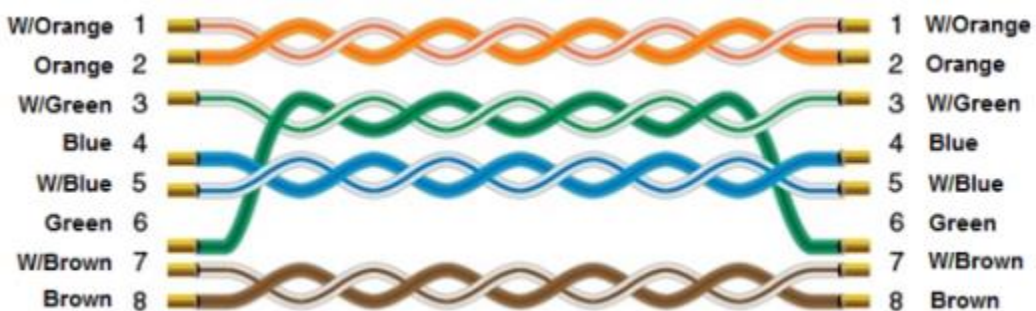


Tag information successfully imported.



Wiring Diagram:

Ethernet cable:



Siemens TI505

Supported Series: SIMATIC TI505 Series PLCs: TI520, TI525, TI530, TI535, TI545, TI555, TI560, TI565, TI575. Use NITP protocol in a point-to-point, single master, single slave format.

CTI 2500 Series PLCs (Classic and Compact): C100, C200, C300 and C400.

Website Siemens: <http://www.siemens.com/entry/cc/en/>

Website CTI: <http://www.controltechnology.com/>

HMI Setting:

Parameters	Recommended	Options	Notes
PLC type	SIMATIC TI505		NITP protocol
PLC I/F	RS232	RS232, RS485 4W	
Baud rate	19200	19200	
Data bits	7	7	
Parity	Odd	Odd	
Stop bits	1	1	
PLC sta. no.	0	Does not apply	

Device Address:

Bit/Word	Device type	Format	Range	Memo
B	CR	DDDDD	1 ~ 65535	Internal Relay
B	X	DDDDD	1 ~ 65535	Discrete Input Coils
B	Y	DDDDD	1 ~ 65535	Discrete Output Coils
B	V_Bit	DDDDDdd	101 ~ 6553616	User Data Register Bits
W	V	DDDDD	1 ~ 65535	User Data Registers
DW	VD	DDDDD	1 ~ 65536	User Data Registers (32bit)
W	STW	DDDDD	1 ~ 65535	Status Word Registers
W	TCP	DDDDD	1 ~ 65535	Timer/Counter Preset Values
W	TCC	DDDDD	1 ~ 65535	Timer/Counter Current Values
W	WX	DDDDD	1 ~ 65535	Word Discrete Inputs
W	WY	DDDDD	1 ~ 65535	Word Discrete Outputs

Wiring Diagram:

RS-232 25P D-Sub (Diagram1 ~ Diagram 3)

Diagram 1

cMT Series	<i>cMT3151</i>
eMT Series	<i>eMT3070 / eMT3105 / eMT3120 / eMT3150</i>
MT-iE	<i>MT8073iE / MT8102iE</i>
MT-XE	<i>MT8092XE</i>
MT-iP	<i>MT6103iP</i>

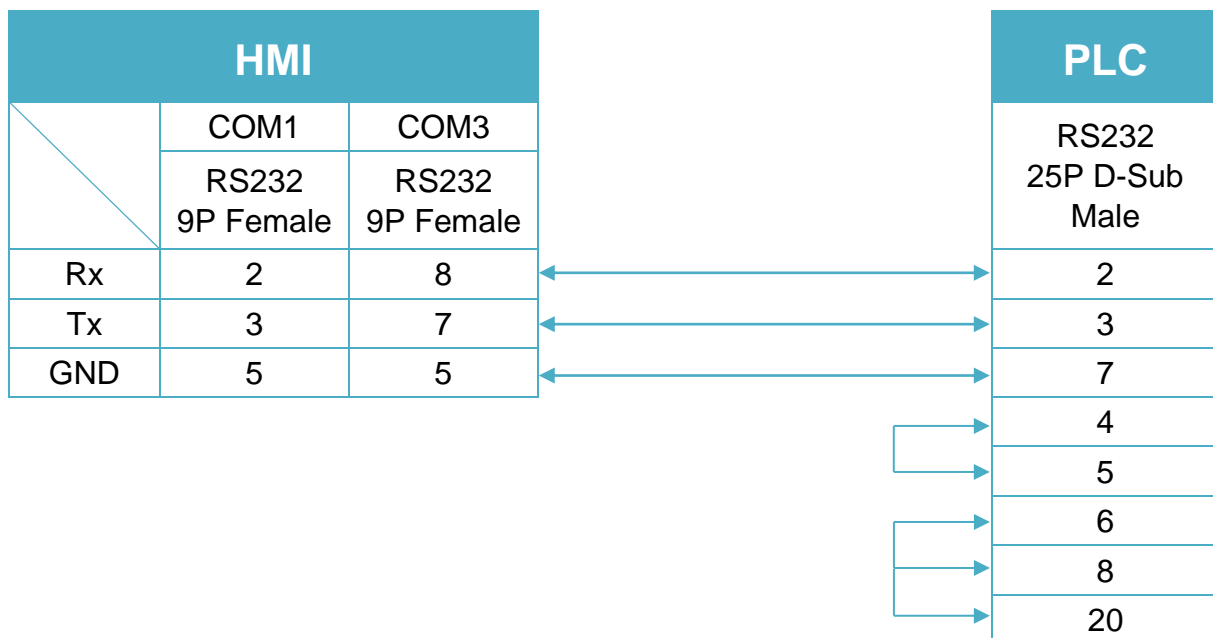
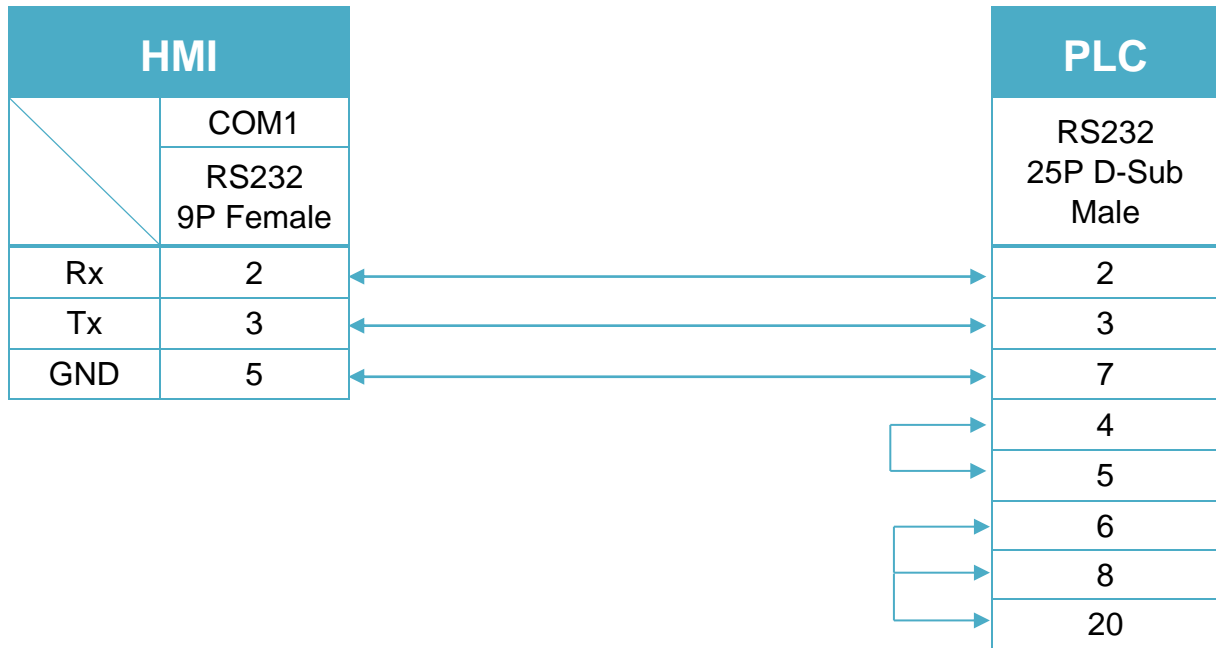


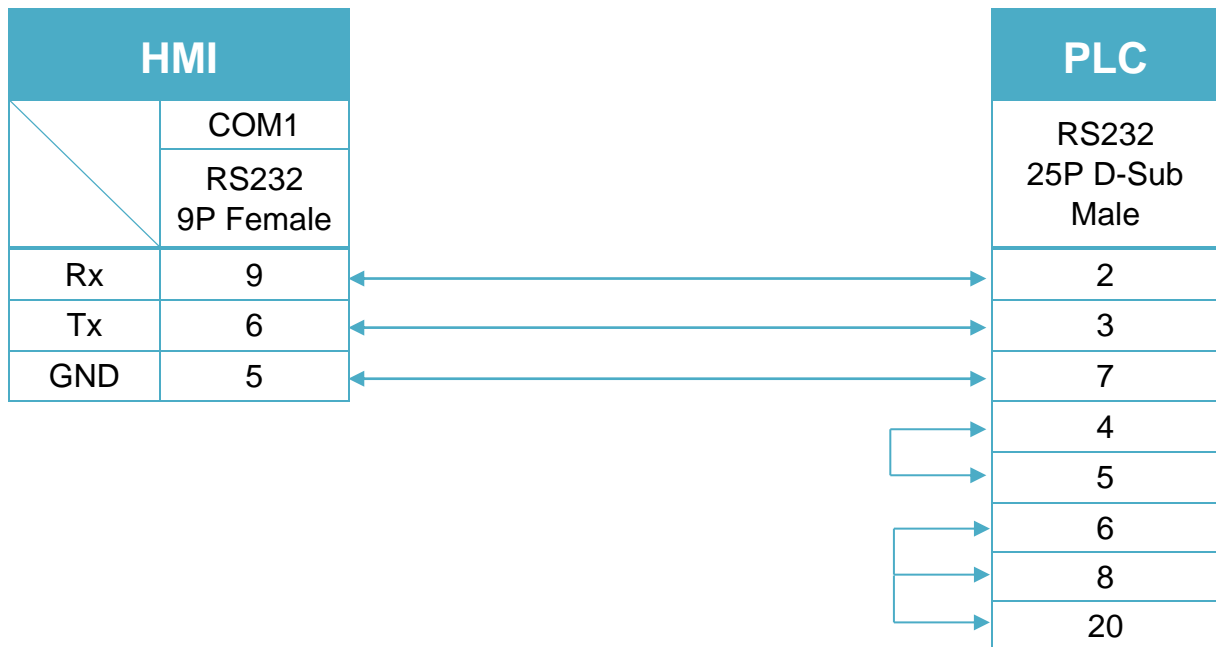
Diagram 2

cMT Series	<i>cMT-SVR</i>
mTV	<i>mTV</i>
MT-iE	<i>MT8070iE / MT6070iE / MT8100iE / MT8121iE / MT8150iE / MT8071iE / MT6071iE / MT8072iE / MT6072iE / MT8073iE / MT8101iE / MT8102iE / MT8103iE</i>
MT-XE	<i>MT8121XE / MT8150XE / MT8090XE</i>


Diagram 3

MT-iE *MT8050iE*

MT-iP *MT6051iP / MT6071iP / MT8071iP*



RS-232 9P D-Sub (Diagram4 ~ Diagram 7)

Diagram 4

cMT Series	<i>cMT3151</i>
eMT Series	<i>eMT3070/ eMT3105 / eMT3120 / eMT3150</i>
MT-iE	<i>MT8073iE / MT8102iE</i>
MT-XE	<i>MT8092XE</i>
MT-iP	<i>MT6103iP</i>

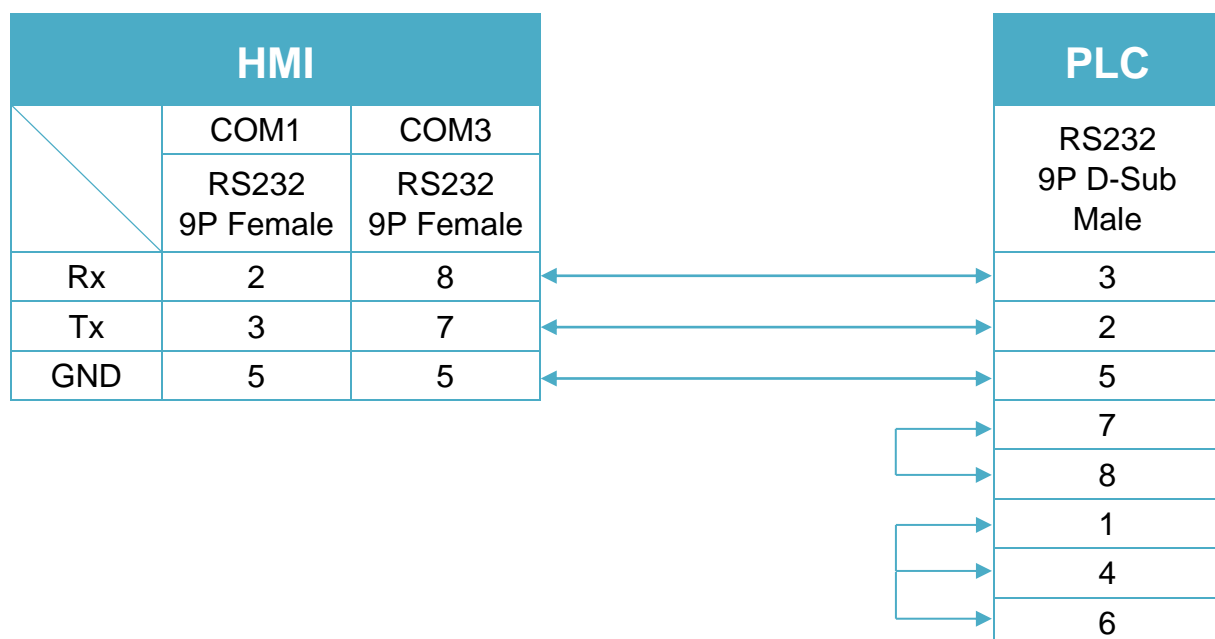
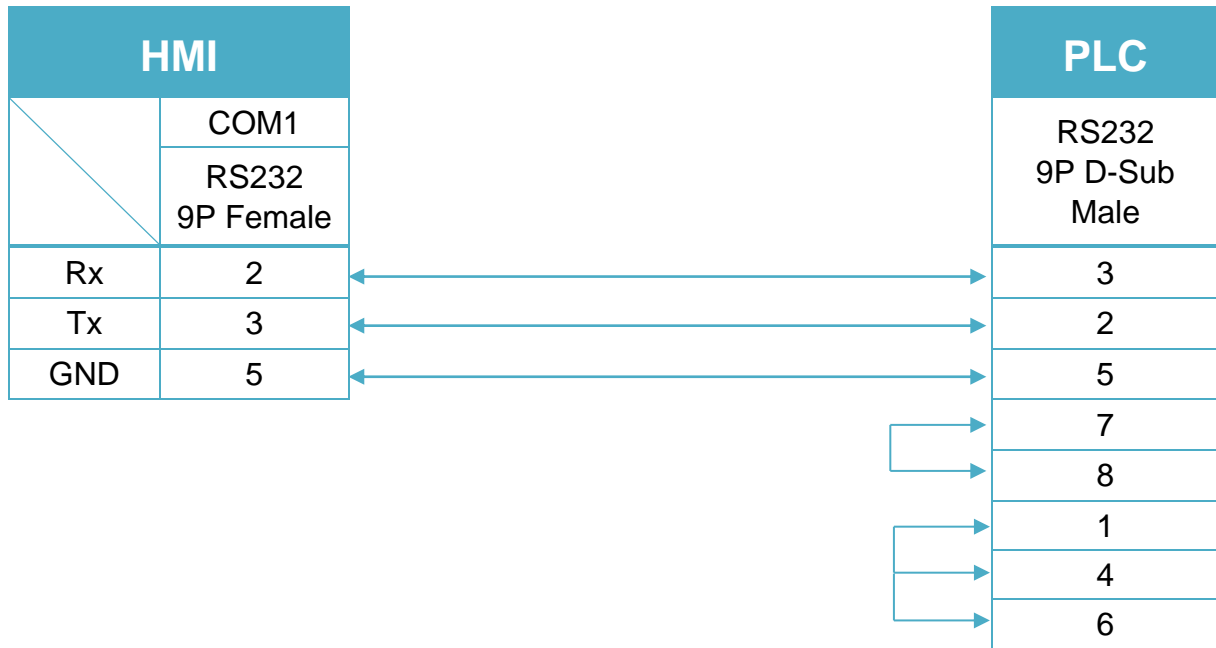


Diagram 5

cMT Series	<i>cMT-SVR</i>
mTV	<i>mTV</i>
MT-iE	<i>MT8070iE / MT6070iE / MT8100iE / MT8121iE / MT8150iE / MT8071iE / MT6071iE / MT8072iE / MT6072iE / MT8073iE / MT8101iE / MT8102iE / MT8103iE</i>
MT-XE	<i>MT8121XE / MT8150XE / MT8090XE</i>


Diagram 6

MT-iE *MT8050iE*

MT-iP *MT6051iP / MT6071iP / MT8071iP*

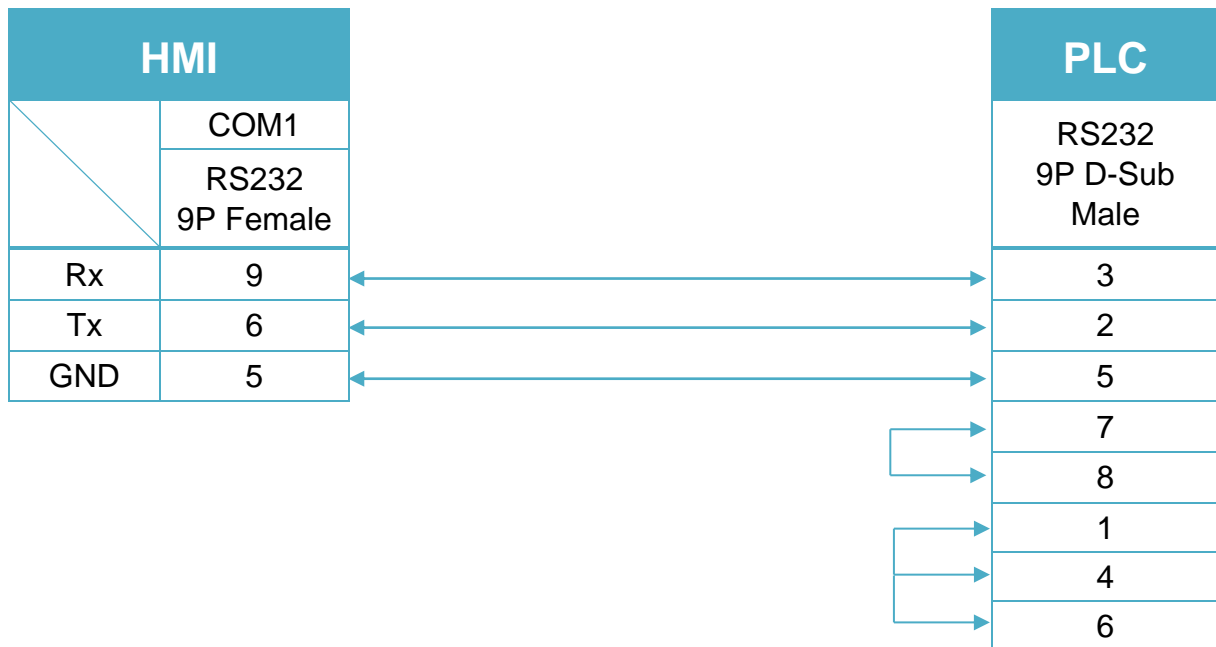
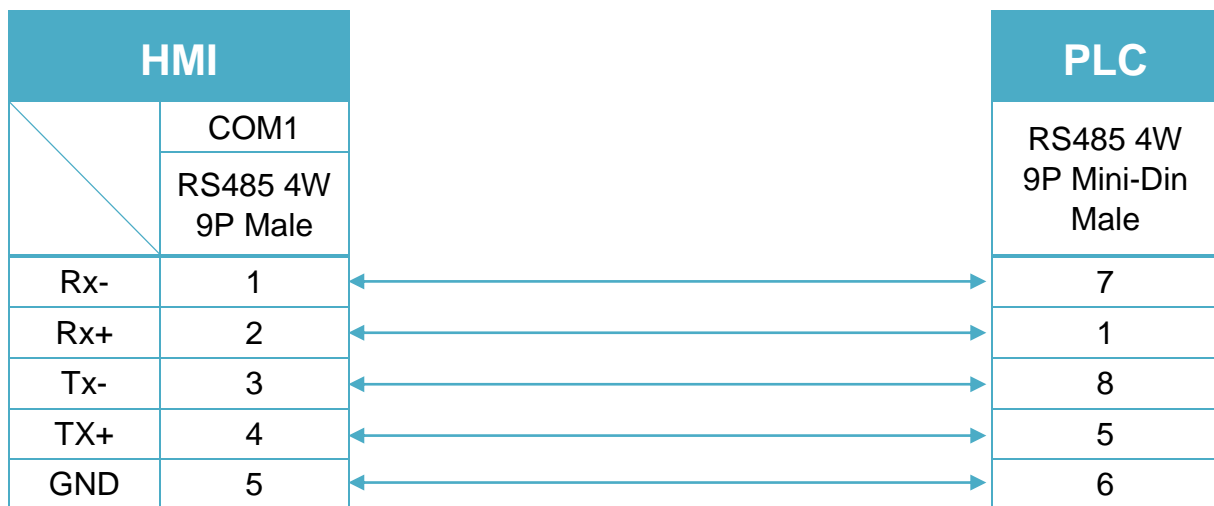


Diagram 7

cMT Series	<i>cMT3151</i>
eMT Series	<i>eMT3070 / eMT3105 / eMT3120 / eMT3150</i>
MT-iE	<i>MT8070iE / MT6070iE / MT8100iE / MT8121iE / MT8150iE</i>
MT-XE	<i>MT8121XE / MT8150XE</i>



RS-485 4W Mini-Din (Diagram8 ~ Diagram 10)

.Diagram 8

cMT Series	<i>cMT-SVR</i>
mTV	<i>mTV</i>

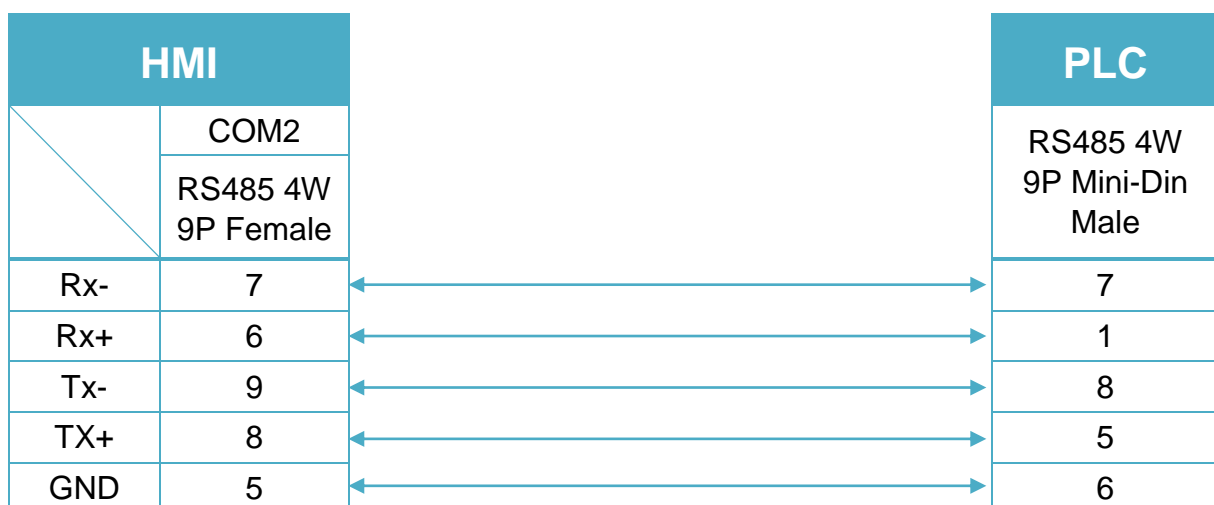


Diagram 9

MT-iE	<i>MT8071iE / MT6071iE / MT8072iE / MT6072iE / MT8073iE / MT8101iE / MT8102iE / MT8103iE</i>
MT-XE	<i>MT8090XE / MT8092XE</i>
MT-iP	<i>MT6071iP / MT8071iP / MT6103iP</i>

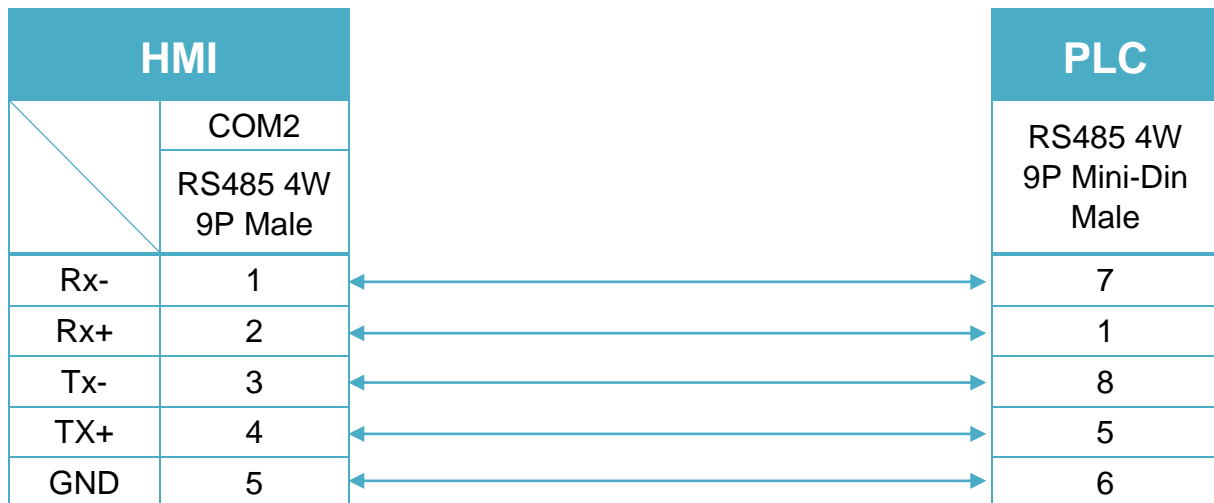
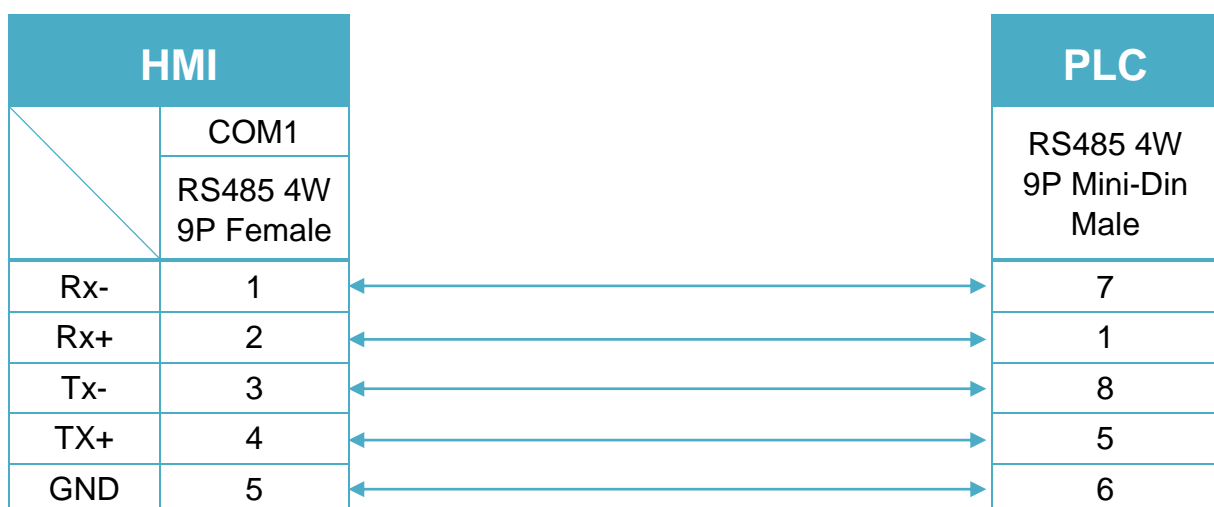


Diagram 10

MT-iE	<i>MT8050iE</i>
MT-iP	<i>MT6051iP</i>



Siemens TI505 (Ethernet)

Supported Series: SIMATIC TI505 Series PLCs: TI520, TI525, TI530, TI535, TI545, TI555, TI560, TI565, TI575 with ethernet module.

CTI 2500 Series PLCs (Classic and Compact): C100, C200, C300 and C400

Website Siemens: <http://www.siemens.com/entry/cc/en/>

Website CTI: <http://www.controltechnology.com/>

HMI Setting:

Parameters	Recommended	Options	Notes
PLC type	Siemens TI505 (Ethernet)		
PLC I/F	Ethernet		
Port no.	1505		
PLC sta. no.	1		

Device Address:

Bit/Word	Device type	Format	Range	Memo
B	CR	DDDDD	1 ~ 65536	Internal Relay
B	X	DDDDD	1 ~ 65536	Discrete Input Coils
B	Y	DDDDD	1 ~ 65536	Discrete Output Coils
B	V_Bit	DDDDDdd	101 ~ 6553616	User Data Register Bits
W	V	DDDDD	1 ~ 65536	User Data Registers
DW	VD	DDDDD	1 ~ 65535	User Data Registers (32bit)
W	STW	DDDDD	1 ~ 65536	Status Word Registers
W	TCP	DDDDD	1 ~ 65536	Timer/Counter Preset Values
W	TCC	DDDDD	1 ~ 65536	Timer/Counter Current
W	WX	DDDDD	1 ~ 65536	Word Discrete Inputs
W	WY	DDDDD	1 ~ 65536	Word Discrete Outputs

Wiring Diagram:

Ethernet cable:



Siemens TI565

Supported Series: SIMATIC TI565

Website: <http://www.siemens.com/entry/cc/en/>

HMI Setting:

Parameters	Recommended	Options	Notes
PLC type	SIMATIC TI565		
PLC I/F	RS232	RS232, RS485 4W	
Baud rate	19200	19200	
Data bits	7	7	
Parity	Odd	Odd	
Stop bits	1	1	
PLC sta. no.	0	Does not apply	

Device Address:

Bit/Word	Device type	Format	Range	Memo
B	CR	DDDDD	1 ~ 65535	Internal Relay
B	X	DDDDD	1 ~ 65535	Discrete Input Coils
B	Y	DDDDD	1 ~ 65535	Discrete Output Coils
W	V	DDDDD	1 ~ 65535	User Data Registers
DW	VD	DDDDD	1 ~ 65535	User Data Registers (32bit)
W	STW	DDDDD	1 ~ 65535	Status Word Registers
W	TCP	DDDDD	1 ~ 65535	Timer/Counter Preset Values
W	TCC	DDDDD	1 ~ 65535	Timer/Counter Current Values
W	WX	DDDDD	1 ~ 65535	Word Discrete Inputs
W	WY	DDDDD	1 ~ 65535	Word Discrete Outputs

Wiring Diagram:

RS-232 25P D-Sub (Diagram1 ~ Diagram 3)

Diagram 1

cMT Series	<i>cMT3151</i>
eMT Series	<i>eMT3070 / eMT3105 / eMT3120 / eMT3150</i>
MT-iE	<i>MT8073iE / MT8102iE</i>
MT-XE	<i>MT8092XE</i>
MT-iP	<i>MT6103iP</i>

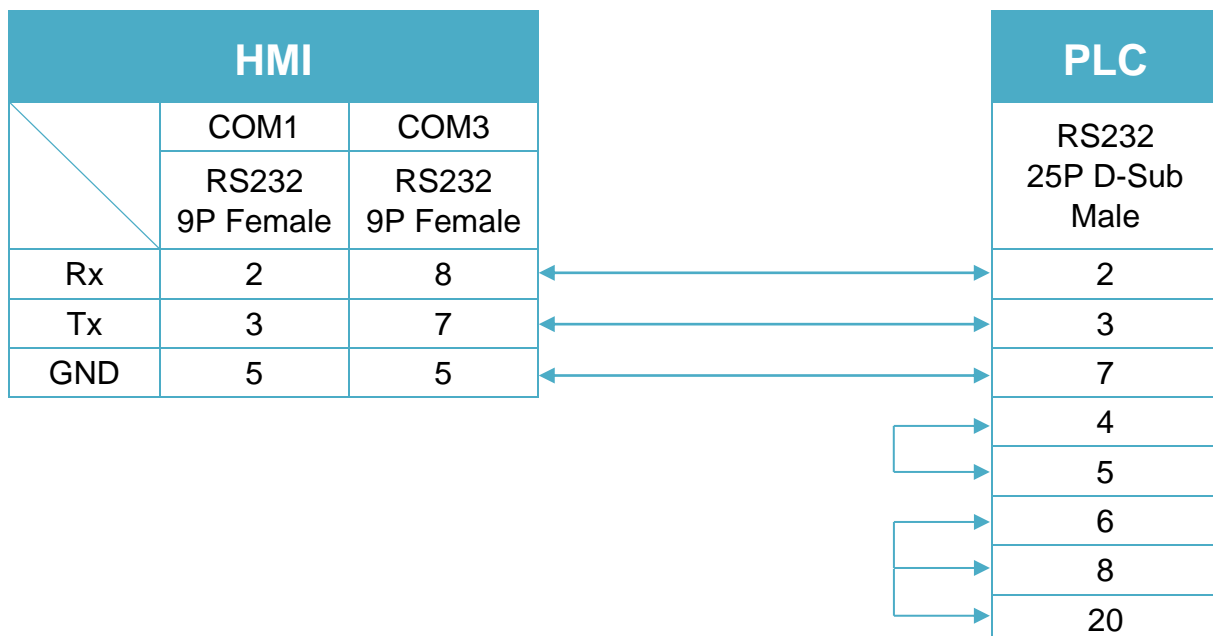
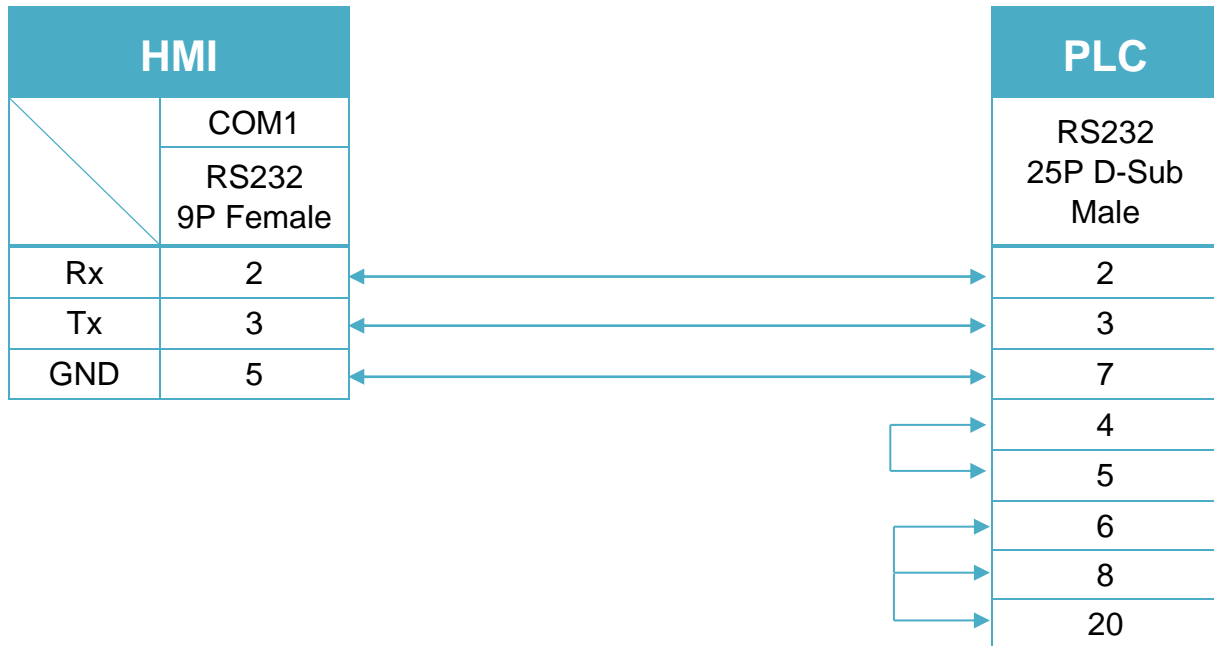
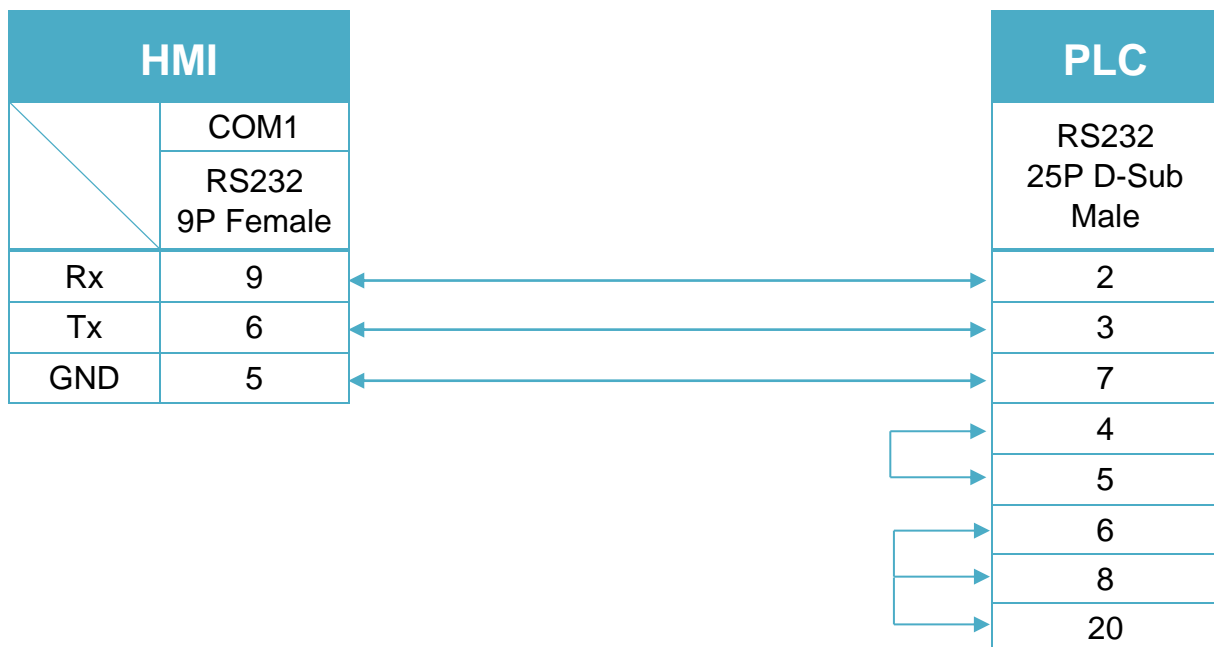


Diagram 2

cMT Series	<i>cMT-SVR</i>
mTV	<i>mTV</i>
MT-iE	<i>MT8070iE / MT6070iE / MT8100iE / MT8121iE / MT8150iE / MT8071iE / MT6071iE / MT8072iE / MT6072iE / MT8073iE / MT8101iE / MT8102iE / MT8103iE</i>
MT-XE	<i>MT8121XE / MT8150XE / MT8090XE</i>


Diagram 3
MT-iE
MT8050iE
MT-iP
MT6051iP / MT6071iP / MT8071iP


RS-232 9P D-Sub (Diagram4 ~ Diagram6)

Diagram 4

cMT Series	<i>cMT3151</i>
eMT Series	<i>eMT3070 / eMT3105 / eMT3120 / eMT3150</i>
MT-iE	<i>MT8073iE / MT8102iE</i>
MT-XE	<i>MT8092XE</i>
MT-iP	<i>MT6103iP</i>

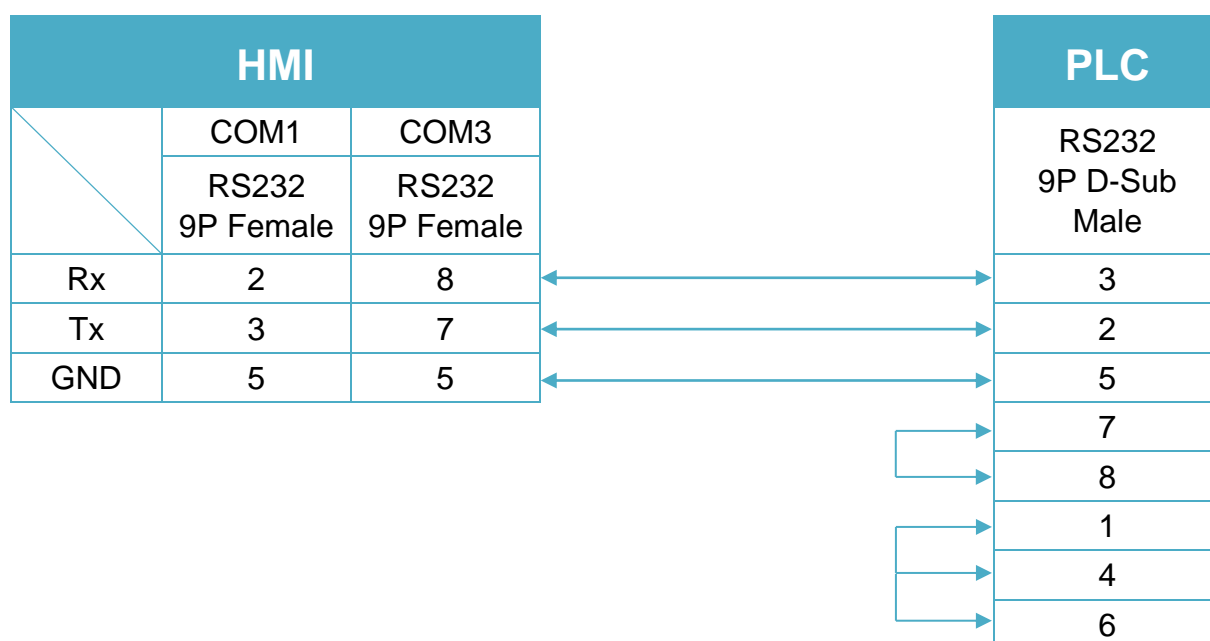
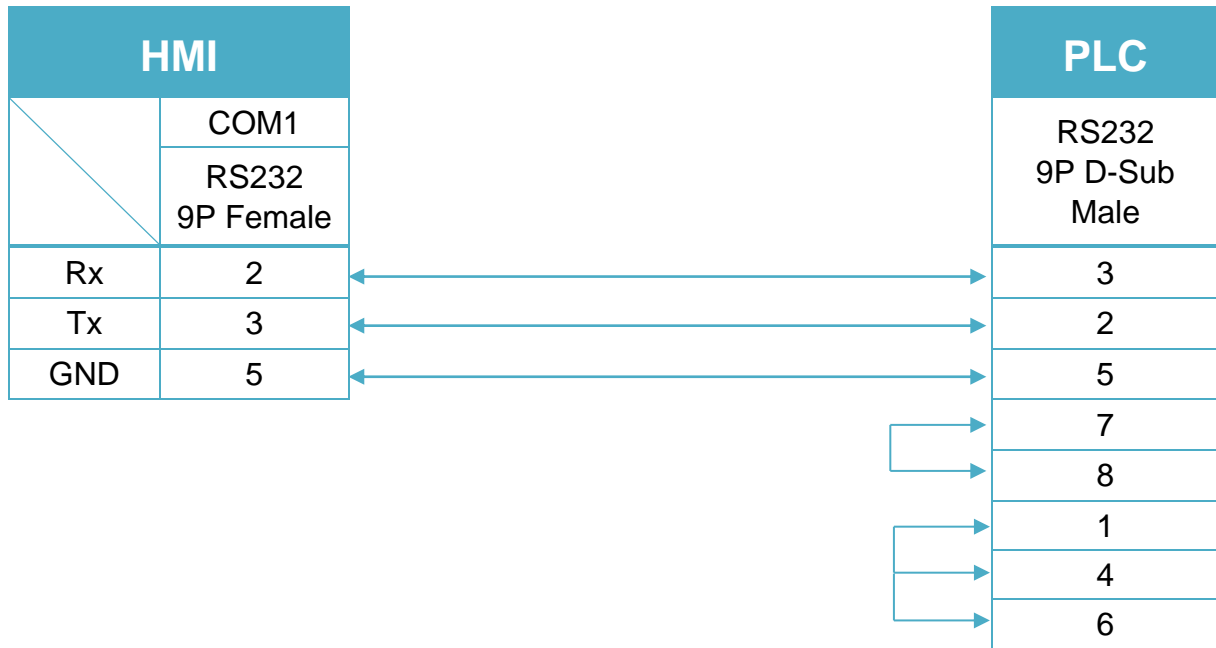


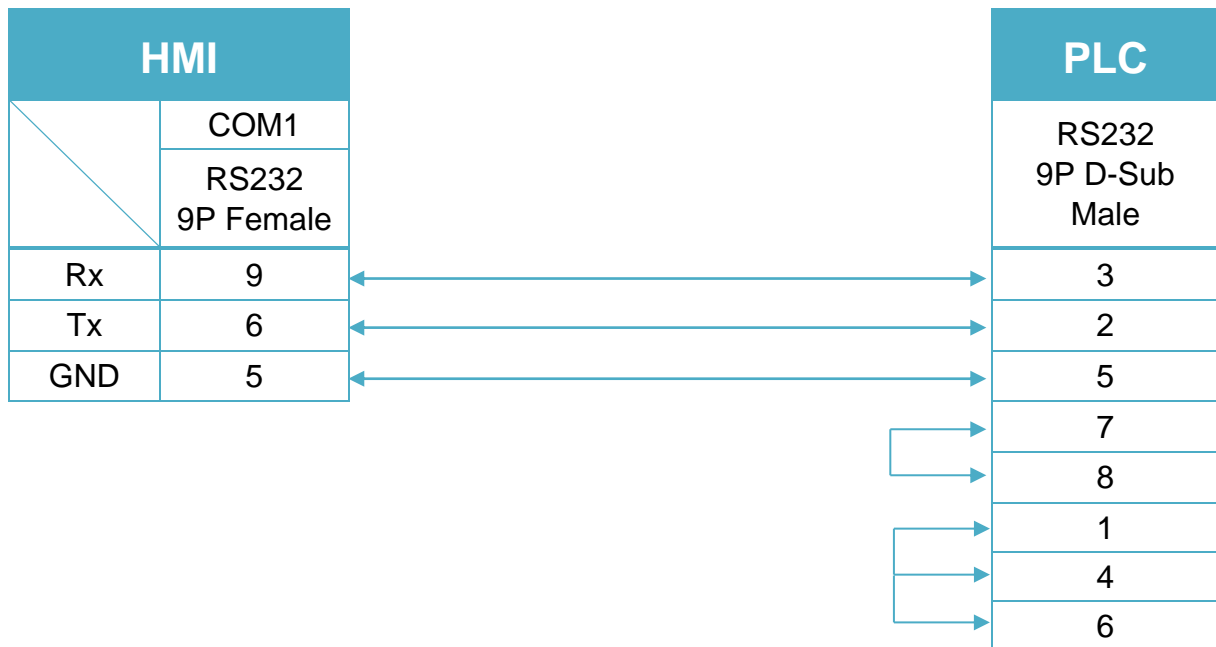
Diagram 5

cMT Series	<i>cMT-SVR</i>
mTV	<i>mTV</i>
MT-iE	<i>MT8070iE / MT6070iE / MT8100iE / MT8121iE / MT8150iE / MT8071iE / MT6071iE / MT8072iE / MT6072iE / MT8073iE / MT8101iE / MT8102iE / MT8103iE</i>
MT-XE	<i>MT8121XE / MT8150XE / MT8090XE</i>


Diagram 6

MT-iE *MT8050iE*

MT-iP *MT6051iP / MT6071iP / MT8071iP*



RS 485 4W 8P Mini-Din (Diagram7 ~ Diagram 10)

Diagram 7

cMT Series	<i>cMT3151</i>
eMT Series	<i>eMT3070 / eMT3105 / eMT3120 / eMT3150</i>
MT-iE	<i>MT8070iE / MT6070iE / MT8100iE / MT8121iE / MT8150iE</i>
MT-XE	<i>MT8121XE / MT8150XE</i>

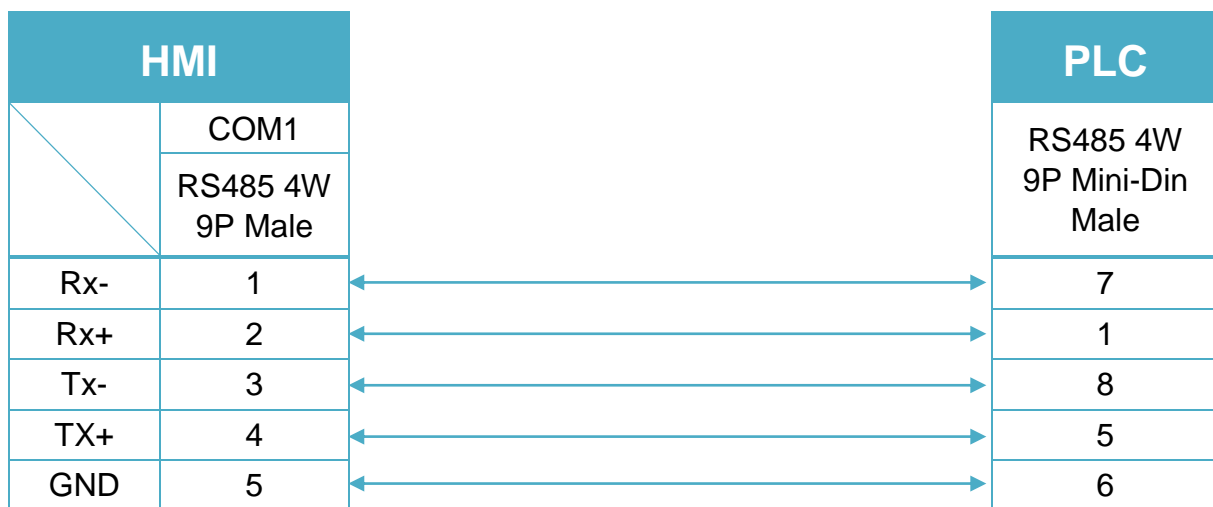


Diagram 8

cMT Series	<i>cMT-SVR</i>
mTV	<i>mTV</i>

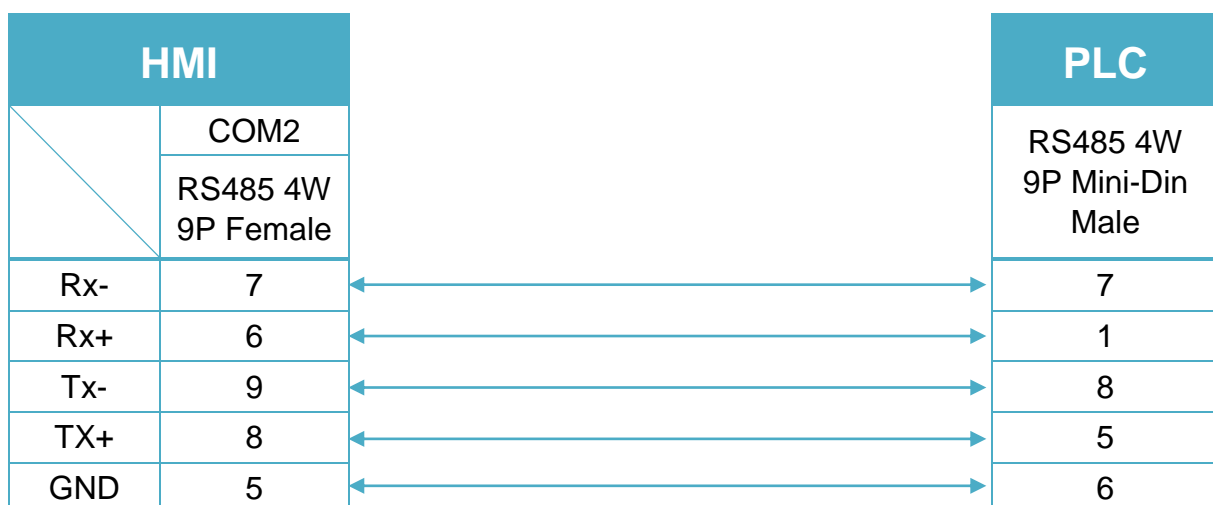


Diagram 9

MT-iE	<i>MT8071iE / MT6071iE / MT8072iE / MT6072iE / MT8073iE / MT8101iE / MT8102iE / MT8103iE</i>
MT-XE	<i>MT8090XE / MT8092XE</i>
MT-iP	<i>MT6071iP / MT8071iP / MT6103iP</i>

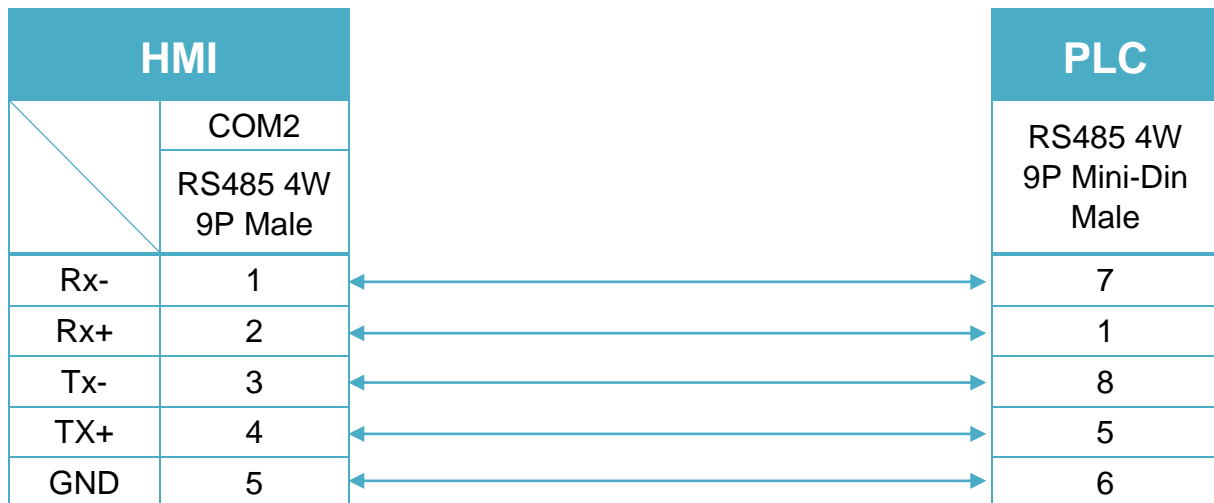
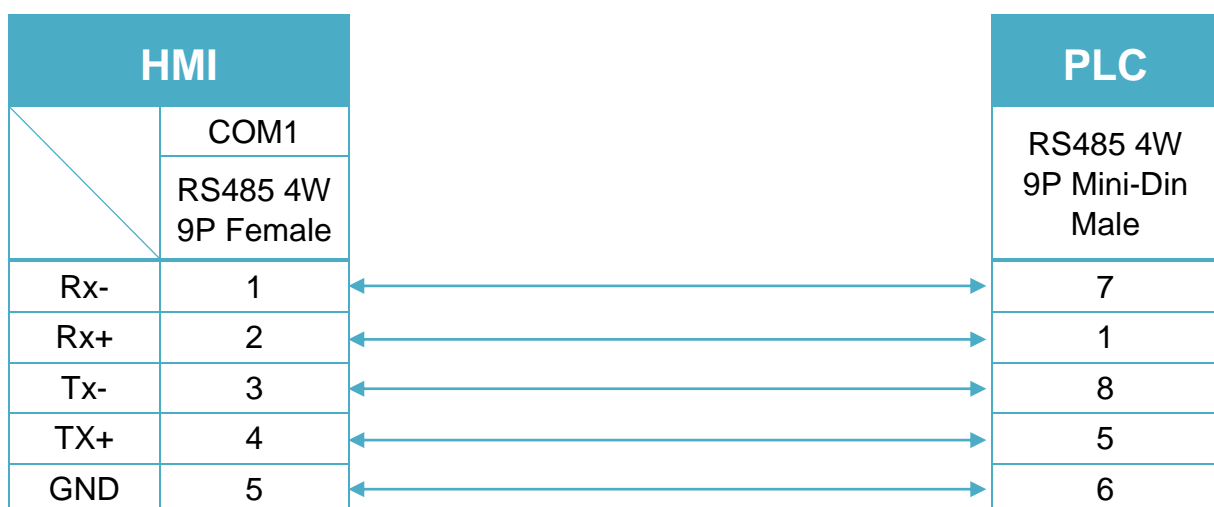


Diagram 10

MT-iE	<i>MT8050iE</i>
MT-iP	<i>MT6051iP</i>



SIGMATEK S-DIAS CPU (Ethernet)

Supported Series: SIGMATEK S-DIAS Digital Mix DM162

Website: <http://www.sigmatek-automation.com/en/>

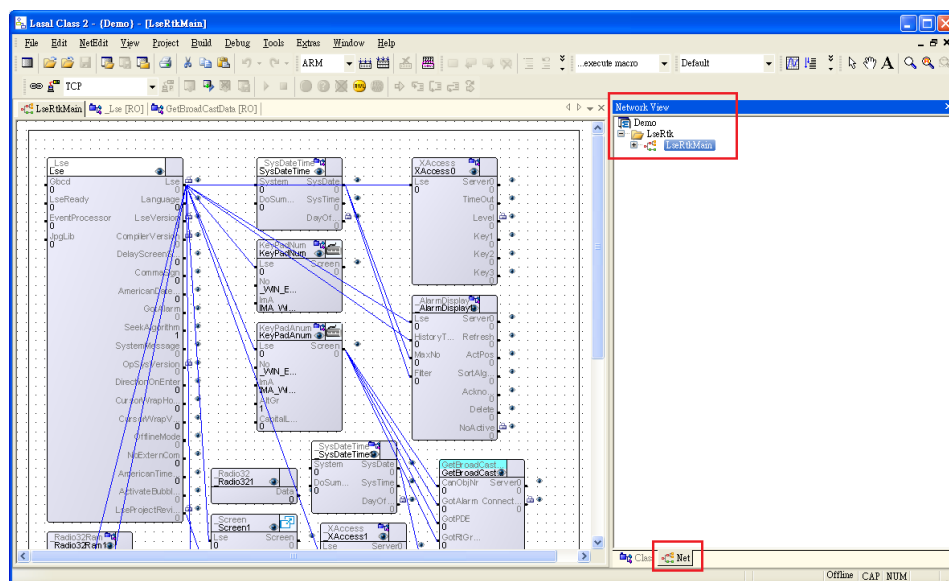
HMI Setting:

Parameters	Recommended	Options	Notes
PLC type	SIGMATEK S-DIAS CPU (Ethernet)		
PLC I/F	Ethernet		
Port no.	1956		
PLC sta. no.	0		

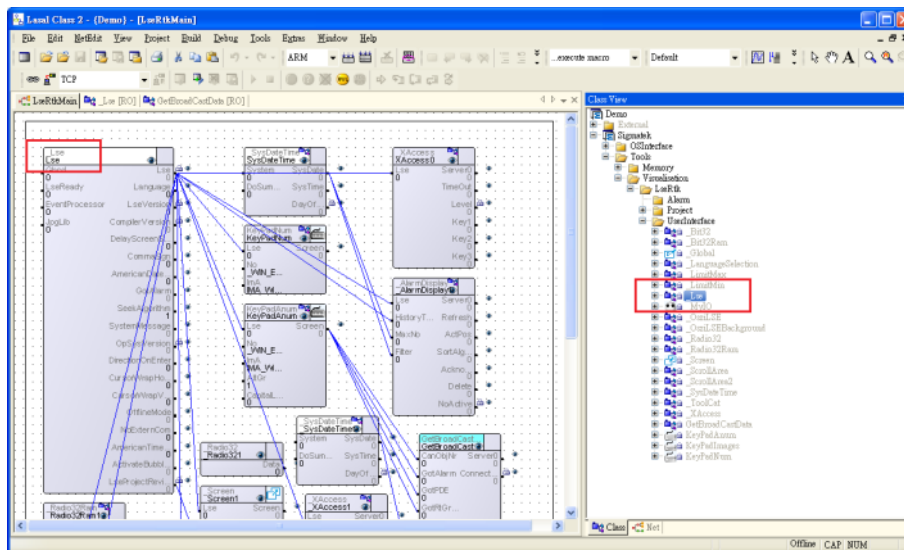
On-line simulator	Yes	Multi-HMI connect	Yes
--------------------------	-----	--------------------------	-----

How to Import Tag:

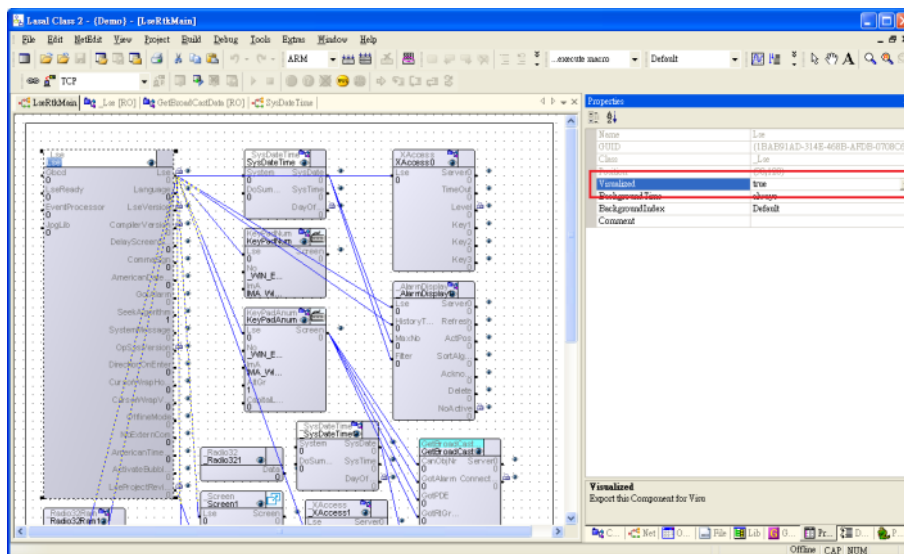
1. Launch **LASAL Class 2**, click **Network View** tab, and the software editing area opens.



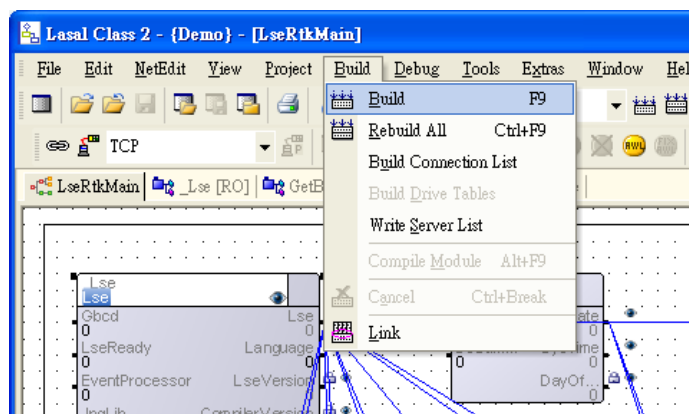
2. Switch to **Class View** tab and drag the object to the editing area.



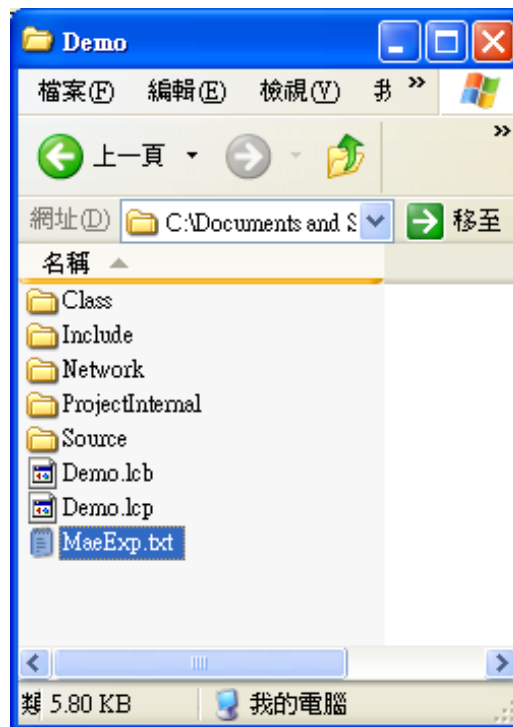
3. In the editing area select the object, and in **Properties** tab select **true** for **Visualized**.



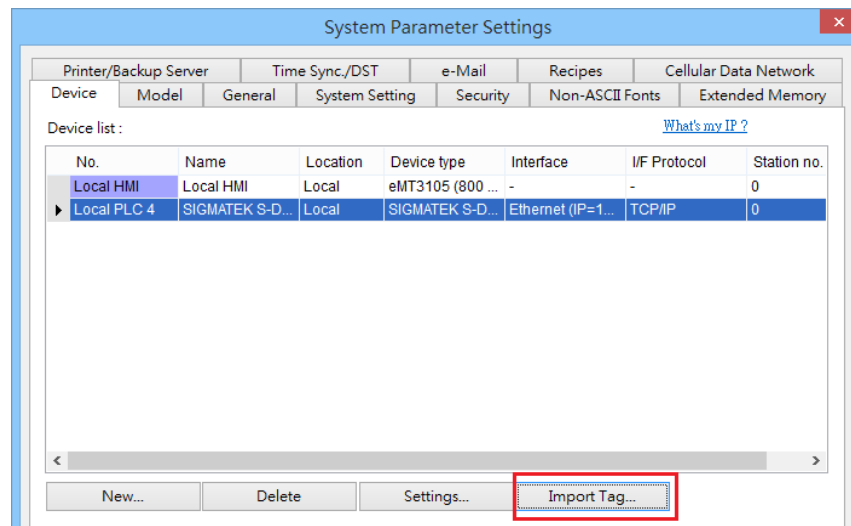
4. **Build** the file.



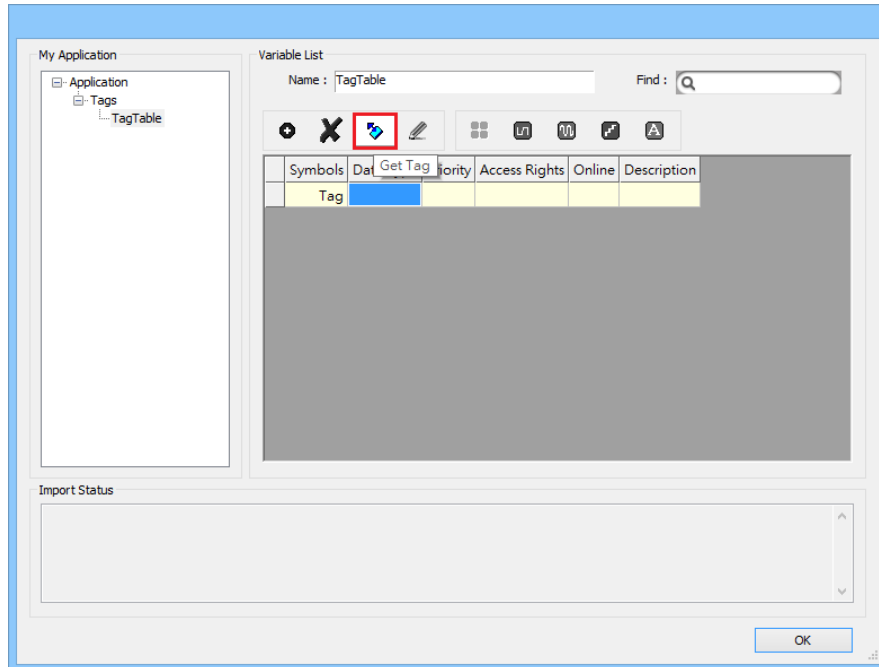
5. After editing, the **MaeExp.txt** file will be generated under the project folder, and the file can be imported to EasyBuilder. If **false** was selected for Visualized in step 3, then the file will not be imported to EasyBuilder.



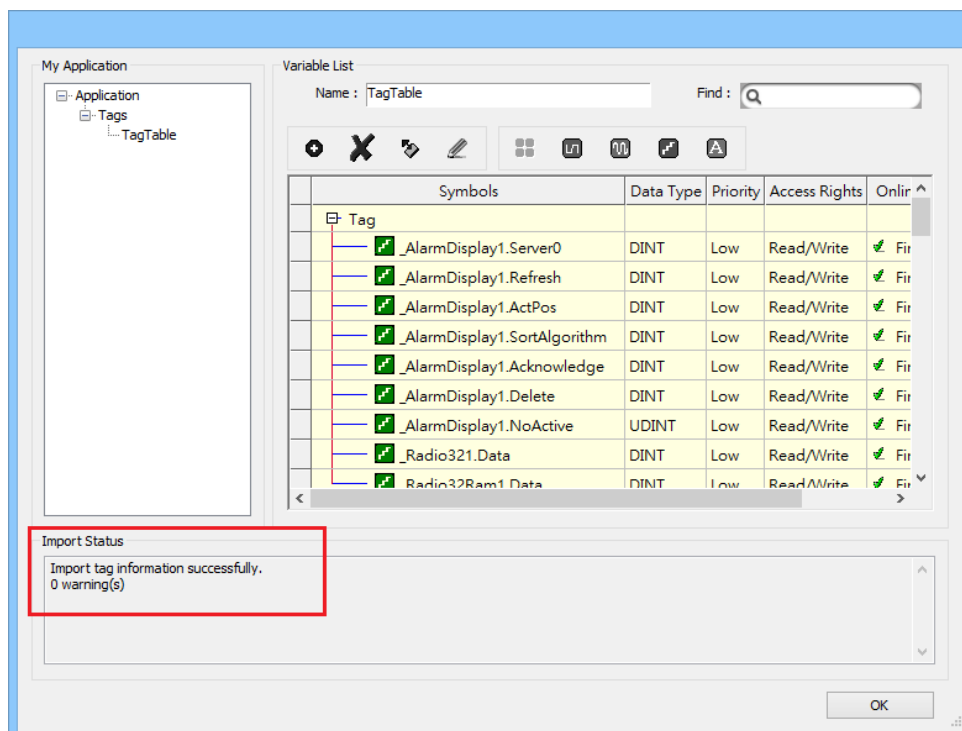
6. Launch EasyBuilder, select SIGMATEK driver and set the parameters, and then select **Import Tag**.



- Click **Get Tag » Verifying tags with PLC**, and then select the MaeExp.txt file generated in step 5. Please check that the PLC is on line for verification. The address tags can also be imported by clicking **Get Tag » Import Tag**, and then run off-line simulation. Please note that on-line simulation and download cannot be carried out using this method.



- See the result in **Import Status** field.



Support Device Type:

Data type	EasyBuilder data format	Memo
Bool	bit	
Byte	16-bit BCD, Hex, Binary, Unsigned	8-bit
SInt	16-bit BCD, Hex, Binary, Signed	8-bit
USInt	16-bit BCD, Hex, Binary, Unsigned	8-bit
Word	16-bit BCD, Hex, Binary, Unsigned	16-bit
Int	16-bit BCD, Hex, Binary, Signed	16-bit
UInt	16-bit BCD, Hex, Binary, Unsigned	16-bit
DWord	32-bit BCD, Hex, Binary, Unsigned	32-bit
DInt	32-bit BCD, Hex, Binary, Signed	32-bit
Real	32-bit Float	32-bit
UDInt	32-bit BCD, Hex, Binary, Unsigned	32-bit
String	ASCII (Use Unicode)	16-bit

Wiring Diagram:

Ethernet Cable:



SSTC SSD Series

Supported Series: SSTC SSD Series

HMI Setting:

Parameters	Recommended	Options	Notes
PLC type	SSTC SSD Series		
PLC I/F	RS232	RS232/RS485 2W	
Baud rate	19200	9600~115200	
Data bits	8	8	
Parity	None	None,Odd	
Stop bits	1	1	
PLC sta. no.	1	1~32	

X Series does not support RS-485 2W communication.

Device Address:

Bit/Word	Device Type	Format	Range	Memo
W	ID	DDDDD	0 ~ 99999	
W	ID_30	DDDDD	30	Use Unicode
W	ID_35000	DDDDD	35000	String
W	ID_35001	DDDDD	35001	String

ID Address List:

ID No.	Data Length	Data Type	Write / Read	Decimal Place*
1	BYT2	UDEC	Yes/Yes	1
30	BYT4	HEX	No/Yes	Hex
36	BYT4	SDEC	Yes/Yes	0.0001
38	BYT4	UDEC	Yes/Yes	0.0001
39	BYT4	SDEC	Yes/Yes	0.0001
40	BYT4	SDEC	No/Yes	0.0001
41	BYT4	SDEC	No/Yes	0.0001
43	BYT2	UDEC	Yes/Yes	1
47	BYT4	SDEC	Yes/Yes	1
48	BYT4	SDEC	Yes/Yes	1
49	BYT4	SDEC	Yes/Yes	1

50	BYT4	SDEC	Yes/Yes	1
51	BYT4	SDEC	Yes/Yes	1
53	BYT4	SDEC	Yes/Yes	1
55	BYT2	UDEC	Yes/Yes	1
57	BYT4	UDEC	Yes/Yes	1
80	BYT2	SDEC	Yes/Yes	0.1
82	BYT2	UDEC	Yes/Yes	0.1
83	BYT2	SDEC	Yes/Yes	0.1
84	BYT2	SDEC	No/Yes	0.1
85	BYT2	UDEC	Yes/Yes	1
100	BYT2	UDEC	Yes/Yes	1
101	BYT2	UDEC	Yes/Yes	0.1
102	BYT2	UDEC	Yes/Yes	0.1
103	BYT4	SDEC	Yes/Yes	1
104	BYT2	UDEC	Yes/Yes	1
109	BYT4	UDEC	Yes/Yes	0.001
110	BYT4	UDEC	No/Yes	0.001
111	BYT4	UDEC	Yes/Yes	0.001
112	BYT4	UDEC	No/Yes	0.001
113	BYT4	UDEC	Yes/Yes	0.0001
116	BYT4	UDEC	Yes/Yes	1
124	BYT4	SDEC	Yes/Yes	0.0001
125	BYT4	SDEC	Yes/Yes	0.0001
126	BYT2	SDEC	Yes/Yes	0.1
136	BYT4	SDEC	Yes/Yes	1
137	BYT4	SDEC	Yes/Yes	1
147	BYT2	HEX	Yes/Yes	Hex
150	BYT4	SDEC	Yes/Yes	1
153	BYT4	SDEC	Yes/Yes	1
154	BUT2	HEX	Yes/Yes	Hex
157	BYT4	SDEC	Yes/Yes	0.0001
159	BYT4	UDEC	Yes/Yes	1
173	BYT4	SDEC	Yes/Yes	1
193	BYT2	UDEC	Yes/Yes	1
209	BYT4	UDEC	Yes/Yes	0.0001

210	BYT4	UDEC	Yes/Yes	0.0001
211	BYT2	UDEC	Yes/Yes	0.1
212	BYT2	UDEC	Yes/Yes	0.1
222	BYT4	SDEC	Yes/Yes	1
225	BYT2	HEX	Yes/Yes	Hex
228	BYT4	UDEC	Yes/Yes	1
230	BYT4	UDEC	Yes/Yes	1
268	BYT4	UDEC	Yes/Yes	1
278	BYT4	UDEC	Yes/Yes	1
32768	BYT2	UDEC	Yes/Yes	0.1
32769	BYT4	UDEC	Yes/Yes	0.001
32770	BYT4	UDEC	Yes/Yes	0.001
32771	BYT2	UDEC	Yes/Yes	0.1
32772	BYT4	UDEC	Yes/Yes	0.0001
32773	BYT4	HEX	Yes/Yes	Hex
32774	BYT2	UDEC	Yes/Yes	0.1
32775	BYT2	UDEC	Yes/Yes	1
32776	BYT2	UDEC	Yes/Yes	1
32777	BYT2	SDEC	Yes/Yes	0.1
32778	BYT4	SDEC	Yes/Yes	0.0001
32779	BYT4	SDEC	Yes/Yes	0.0001
32780	BYT4	UDEC	Yes/Yes	0.1
32781	BYT4	UDEC	Yes/Yes	0.1
32782	BYT4	UDEC	Yes/Yes	0.1
32783	BYT2	UDEC	Yes/Yes	1
32784	BYT4	SDEC	Yes/Yes	1
32785	BYT2	UDEC	Yes/Yes	1
32786	BYT4	SDEC	Yes/Yes	1
32787	BYT4	UDEC	Yes/Yes	1
32788	BYT4	SDEC	Yes/Yes	1
32789	BYT4	UDEC	Yes/Yes	1
32790	BYT4	SDEC	Yes/Yes	1
32791	BYT4	UDEC	Yes/Yes	1
32792	BYT4	SDEC	Yes/Yes	1
32793	BYT4	UDEC	Yes/Yes	1

32794	BYT4	SDEC	Yes/Yes	1
32797	BYT4	HEX	No/Yes	Hex
32798	BYT4	HEX	No/No	Hex
32799	BYT4	HEX	No/No	Hex
32800	BYT4	HEX	Yes/Yes	Hex
32801	BYT4	HEX	Yes/Yes	Hex
32802	BYT4	HEX	Yes/Yes	Hex
32803	BYT4	HEX	Yes/Yes	Hex
32804	BYT4	HEX	Yes/Yes	Hex
32805	BYT4	HEX	Yes/Yes	Hex
32806	BYT4	UDEC	Yes/Yes	1
32807	BYT4	UDEC	Yes/Yes	1
32808	BYT4	UDEC	Yes/Yes	1
32809	BYT4	UDEC	Yes/Yes	1
32836	BYT2	UDEC	No/Yes	1
32845	BYT2	UDEC	Yes/Yes	1
32846	BYT2	SDEC	Yes/Yes	1
32847	BYT2	SDEC	Yes/Yes	1
32848	BYT2	UDEC	Yes/Yes	1
32849	BYT2	SDEC	Yes/Yes	1
32850	BYT2	SDEC	Yes/Yes	1
32851	BYT2	SDEC	Yes/Yes	1
32852	BYT2	SDEC	Yes/Yes	1
32853	BYT2	SDEC	Yes/Yes	1
32854	BYT2	SDEC	Yes/Yes	1
32865	BYT2	UDEC	Yes/Yes	1
32866	BYT2	UDEC	Yes/Yes	1
32867	BYT2	UDEC	Yes/Yes	1
32868	BYT2	UDEC	Yes/Yes	1
32874	BYT2	UDEC	Yes/Yes	1
32875	BYT2	UDEC	Yes/Yes	1
32876	BYT2	UDEC	Yes/Yes	1
32877	BYT2	UDEC	Yes/Yes	1
32880	BYT2	UDEC	Yes/Yes	1
32881	BYT2	UDEC	Yes/Yes	1

32882	BYT2	UDEC	Yes/Yes	1
32883	BYT2	UDEC	Yes/Yes	1
32891	BYT2	UDEC	Yes/Yes	1
32892	BYT4	UDEC	Yes/Yes	1
32893	BYT4	UDEC	Yes/Yes	1
32922	BYT2	UDEC	Yes/Yes	1
32925	BYT2	HEX	Yes/Yes	Hex
32926	BYT2	HEX	Yes/Yes	Hex
32927	BYT2	HEX	Yes/Yes	Hex
32928	BYT2	UDEC	Yes/Yes	0.1
32929	BYT2	UDEC	Yes/Yes	0.1
32934	BYT2	UDEC	Yes/Yes	1
32935	BYT2	UDEC	Yes/Yes	0.1
32936	BYT4	HEX	Yes/Yes	Hex
32940	BYT4	SDEC	Yes/Yes	1
32947	BYT4	UDEC	Yes/Yes	1
32952	BYT4	UDEC	Yes/Yes	1
32953	BYT2	HEX	Yes/Yes	Hex
32956	BYT2	UDEC	Yes/Yes	1
32958	BYT2	UDEC	Yes/Yes	1
32959	BYT2	UDEC	Yes/Yes	1
32964	BYT2	UDEC	Yes/Yes	1
32966	BYT2	SDEC	Yes/Yes	1
32967	BYT2	UDEC	Yes/Yes	1
32968	BYT2	UDEC	Yes/Yes	0.1
32978	BYT2	UDEC	Yes/Yes	1
32979	BYT2	UDEC	Yes/Yes	1
32980	BYT2	UDEC	Yes/Yes	1
32981	BYT2	UDEC	Yes/Yes	1
32992	BYT2	UDEC	Yes/Yes	0.1
32993	BYT2	UDEC	Yes/Yes	0.1
33700	BYT2	UDEC	Yes/Yes	1
33701	BYT2	UDEC	Yes/Yes	1
33702	BYT2	UDEC	Yes/Yes	1
33703	BYT2	UDEC	Yes/Yes	1

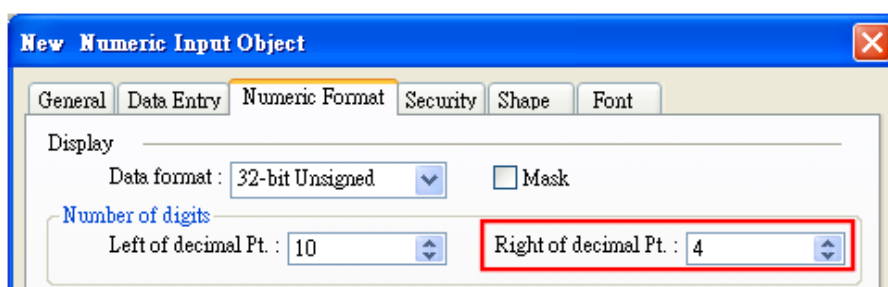
33704	BYT2	UDEC	Yes/Yes	1
33705	BYT2	UDEC	Yes/Yes	1
33706	BYT2	UDEC	Yes/Yes	1
33707	BYT2	UDEC	Yes/Yes	1
33708	BYT2	UDEC	Yes/Yes	1
33709	BYT2	UDEC	Yes/Yes	1
33710	BYT2	UDEC	Yes/Yes	1
33711	BYT2	UDEC	Yes/Yes	1
33712	BYT2	UDEC	Yes/Yes	1
33713	BYT2	UDEC	Yes/Yes	1
33714	BYT2	UDEC	Yes/Yes	1
33721	BYT2	UDEC	Yes/Yes	1
33722	BYT2	UDEC	Yes/Yes	1
33724	BYT2	UDEC	Yes/Yes	1
33725	BYT2	UDEC	Yes/Yes	1
33729	BYT2	UDEC	Yes/Yes	1
33730	BYT2	UDEC	Yes/Yes	1
33731	BYT2	UDEC	Yes/Yes	1
33732	BYT2	UDEC	No/Yes	1
33800	BYT2	UDEC	Yes/Yes	1
33801	BYT2	UDEC	Yes/Yes	1
33802	BYT2	UDEC	Yes/Yes	1
33803	BYT2	UDEC	Yes/Yes	1
33804	BYT2	UDEC	Yes/Yes	1
33805	BYT2	UDEC	Yes/Yes	1
33806	BYT2	UDEC	Yes/Yes	1
33807	BYT2	UDEC	Yes/Yes	1
33808	BYT2	UDEC	Yes/Yes	1
33809	BYT2	UDEC	Yes/Yes	1
33810	BYT2	UDEC	Yes/Yes	1
33811	BYT2	UDEC	Yes/Yes	1
33812	BYT2	UDEC	Yes/Yes	1
33813	BYT2	UDEC	Yes/Yes	1
33814	BYT2	UDEC	Yes/Yes	1
33815	BYT2	UDEC	Yes/Yes	1

33816	BYT2	UDEC	Yes/Yes	1
33817	BYT2	UDEC	Yes/Yes	1
33818	BYT2	UDEC	Yes/Yes	1
33819	BYT2	UDEC	Yes/Yes	1
33820	BYT2	UDEC	Yes/Yes	1
33839	BYT2	UDEC	Yes/Yes	1
33840	BYT2	UDEC	Yes/Yes	1
33859	BYT2	UDEC	Yes/Yes	1
33860	BYT2	UDEC	Yes/Yes	1
33869	BYT2	UDEC	Yes/Yes	1
33880	BYT2	UDEC	Yes/Yes	1
33889	BYT2	UDEC	Yes/Yes	1
33890	BYT2	UDEC	Yes/Yes	1
33899	BYT2	UDEC	Yes/Yes	1
34000	BYT2	UDEC	Yes/Yes	1
34001	BYT2	UDEC	Yes/Yes	1
34002	BYT2	UDEC	Yes/Yes	1
34003	BYT2	UDEC	Yes/Yes	1
34004	BYT2	UDEC	Yes/Yes	1
34005	BYT2	UDEC	Yes/Yes	1
34006	BYT2	UDEC	Yes/Yes	1
34007	BYT2	UDEC	Yes/Yes	1
34008	BYT2	UDEC	Yes/Yes	1
34009	BYT2	UDEC	Yes/Yes	1
34010	BYT2	UDEC	Yes/Yes	1
34011	BYT2	UDEC	Yes/Yes	1
34012	BYT2	UDEC	Yes/Yes	1
34013	BYT2	UDEC	Yes/Yes	1
34014	BYT2	UDEC	Yes/Yes	1
34015	BYT2	UDEC	Yes/Yes	1
34016	BYT2	UDEC	Yes/Yes	1
34017	BYT2	UDEC	Yes/Yes	1
34018	BYT2	UDEC	Yes/Yes	1
34019	BYT2	UDEC	Yes/Yes	1
34023	BYT2	UDEC	Yes/Yes	1

34025	BYT2	UDEC	Yes/Yes	1
34042	BYT2	UDEC	Yes/Yes	1
34043	BYT2	UDEC	Yes/Yes	0.01
34044	BYT2	UDEC	Yes/Yes	0.01
34045	BYT2	UDEC	Yes/Yes	0.01
34046	BYT2	UDEC	Yes/Yes	0.01
34047	BYT2	UDEC	Yes/Yes	0.01
34048	BYT2	UDEC	Yes/Yes	0.01
34049	BYT2	UDEC	Yes/Yes	0.01
34050	BYT2	UDEC	Yes/Yes	0.1
34051	BYT2	UDEC	Yes/Yes	0.01
34052	BYT2	UDEC	Yes/Yes	0.1
34053	BYT2	UDEC	Yes/Yes	1
34054	BYT2	UDEC	Yes/Yes	0.1
34055	BYT2	UDEC	Yes/Yes	0.1
34056	BYT2	UDEC	Yes/Yes	1
34070	BYT2	UDEC	Yes/Yes	1
34148	BYT2	UDEC	Yes/Yes	0.001
34149	BYT2	UDEC	Yes/Yes	0.1
34164	BYT2	UDEC	Yes/Yes	0.01
34167	BYT2	UDEC	Yes/Yes	0.01
34177	BYT2	UDEC	Yes/Yes	1
34178	BYT2	UDEC	Yes/Yes	1
34179	BYT2	UDEC	Yes/Yes	1
34180	BYT2	UDEC	Yes/Yes	1
34182	BYT4	SDEC	Yes/Yes	1
35000	/* Depends on Text */ 0	ASCI	No/Yes	ASCII
35001	/* Depends on Text */ 0	ASCI	No/Yes	ASCII
35002	BYT4	HEX	No/Yes	1
35003	BYT2	HEX	No/Yes	Hex
35004	BYT2	UDEC	No/Yes	0.1
35005	BYT2	UDEC	No/Yes	0.1
35006	BYT2	UDEC	No/Yes	0.1
35007	BYT2	UDEC	No/Yes	0.1
35008	BYT2	UDEC	No/Yes	0.1

35009	BYT2	UDEC	No/Yes	0.1
35010	BYT2	UDEC	No/Yes	0.1
35011	BYT2	UDEC	No/Yes	1
36000	BYT2	UDEC	No/Yes	1
36001	BYT2	UDEC	No/Yes	1
36002	BYT4	SDEC	No/Yes	1
36003	BYT4	SDEC	No/Yes	1
36004	BYT4	UDEC	No/Yes	1
36005	BYT4	UDEC	No/Yes	1
36006	BYT2	UDEC	No/Yes	1
36007	BYT2	UDEC	No/Yes	1
36008	BYT2	UDEC	No/Yes	1
36009	BYT2	UDEC	No/Yes	1
36010	BYT2	UDEC	No/Yes	1
36011	BYT2	UDEC	No/Yes	1
36012	BYT4	UDEC	No/Yes	1
36013	BYT4	UDEC	No/Yes	1
36019	BYT2	UDEC	Yes/Yes	1
36020	BYT2	UDEC	Yes/Yes	1
36021	BYT2	UDEC	Yes/Yes	1
36022	BYT2	UDEC	Yes/Yes	1
36023	BYT2	UDEC	Yes/Yes	1
36100	BYT4	UDEC	Yes/Yes	1
36101	BYT4	UDEC	Yes/Yes	1
36102	BYT4	UDEC	Yes/Yes	1
36103	BYT4	UDEC	Yes/Yes	1
36104	BYT4	UDEC	Yes/Yes	1

*Note: If the decimal place of ID is 0.0001, please set [Right of decimal Pt.] of the object to “4”.



Wiring Diagram:

RS-232 6P 6P Mini-Din (Diagram1 ~ Diagram 3)

Diagram 1

cMT Series	<i>cMT3151</i>
eMT Series	<i>eMT3070 / eMT3105 / eMT3120 / eMT3150</i>
MT-iE	<i>MT8073iE / MT8102iE</i>
MT-XE	<i>MT8092XE</i>
MT-iP	<i>MT6103iP</i>

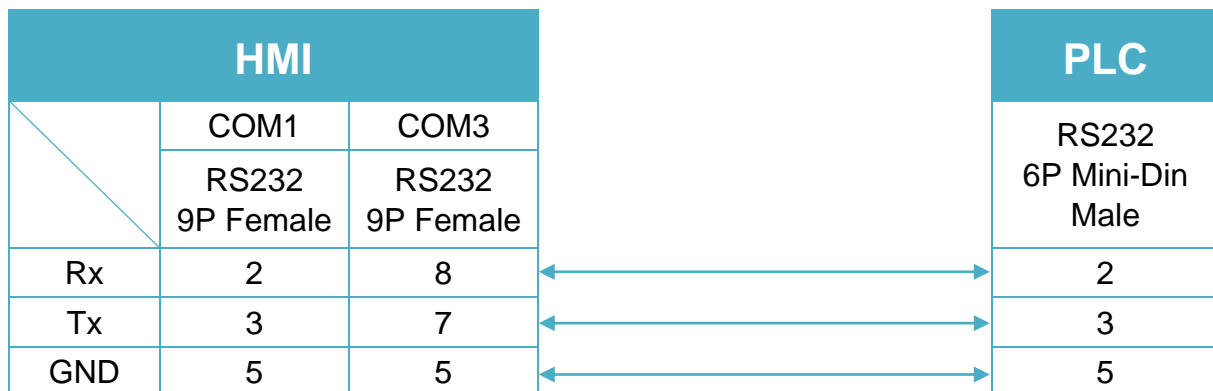


Diagram 2

cMT Series	cMT-SVR
mTV	mTV
MT-iE	MT8070iE / MT6070iE / MT8100iE / MT8121iE / MT8150iE / MT8071iE / MT6071iE / MT8072iE / MT6072iE / MT8073iE / MT8101iE / MT8102iE / MT8103iE
MT-XE	MT8121XE / MT8150XE / MT8090XE

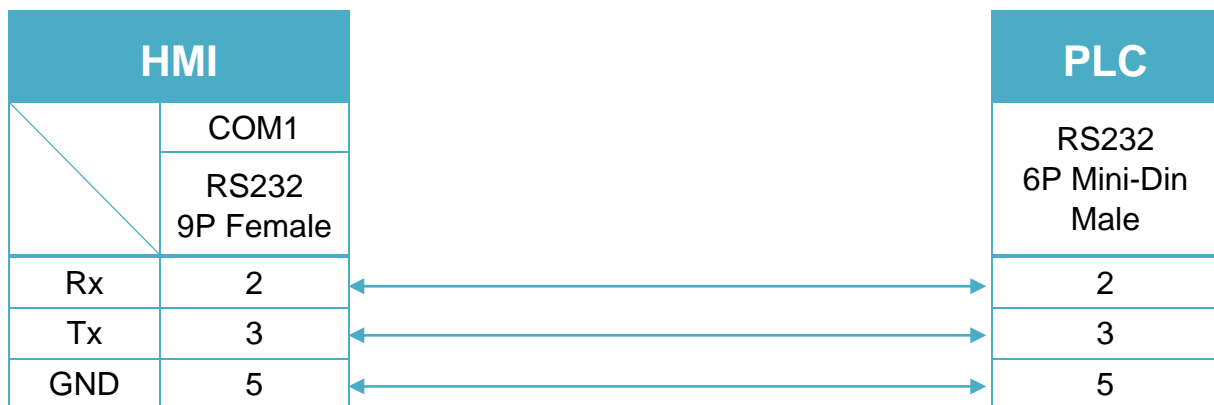
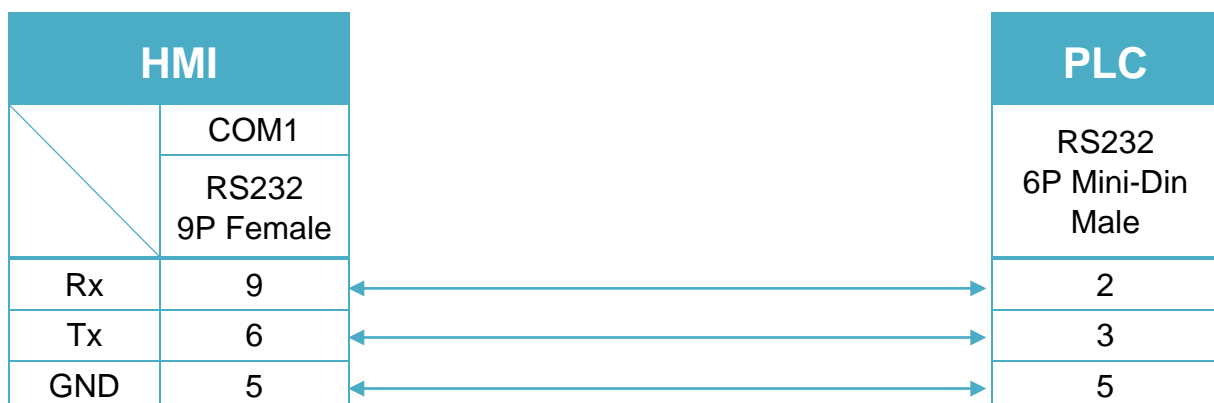


Diagram 3

MT-iE	MT8050iE
MT-iP	MT6051iP / MT6071iP / MT8071iP



RS-485 2W 9P D-Sub (Diagram4 ~ Diagram 9)

Diagram 4

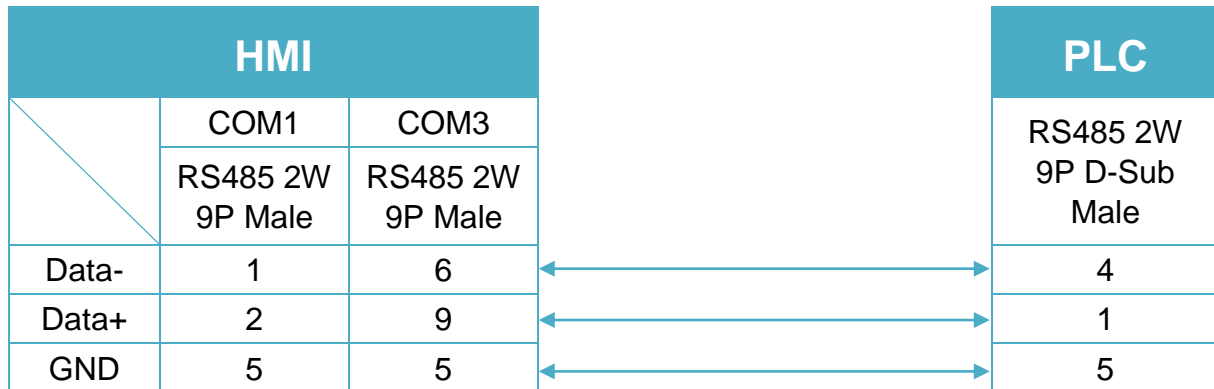
cMT Series
cMT3151
eMT Series
eMT3070/ eMT3105 / eMT3120 / eMT3150


Diagram 5

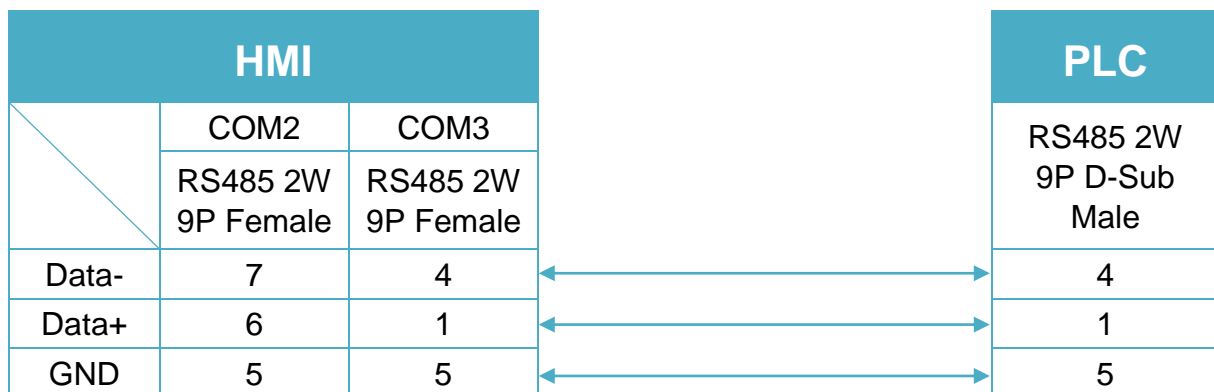
cMT Series
cMT-SVR
mTV
mTV


Diagram 6

MT-iE *MT8070iE / MT6070iE / MT8100iE / MT8121iE / MT8150iE*

MT-XE *MT8121XE / MT8150XE*

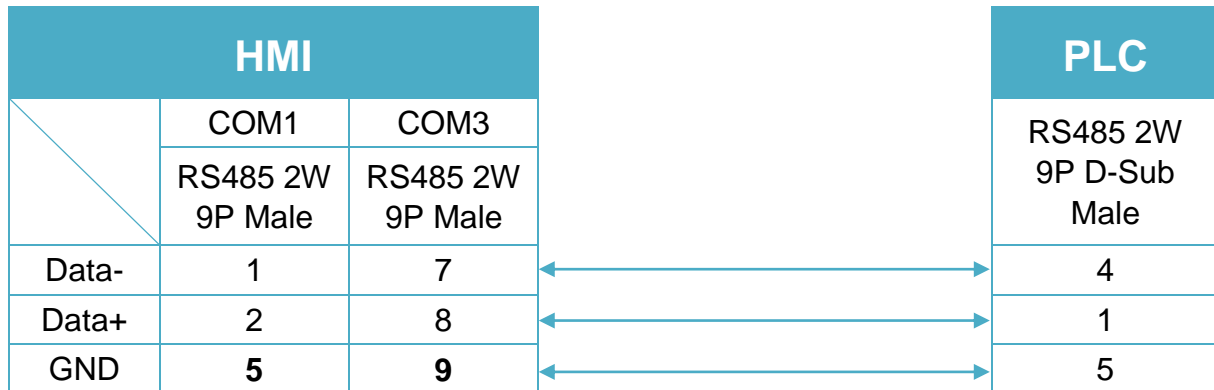


Diagram 7

MT-iE *MT8071iE / MT6071iE / MT8072iE / MT6072iE / MT8073iE /
MT8101iE / MT8102iE / MT8103iE*

MT-XE *MT8090XE / MT8092XE*

MT-iP *MT6103iP*

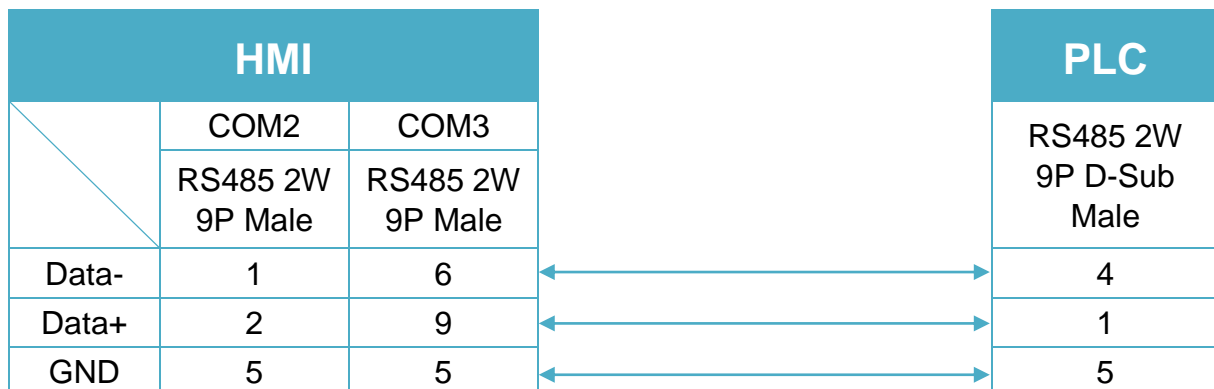


Diagram 8

MT-iE *MT8050iE*

MT-iP *MT6051iP*

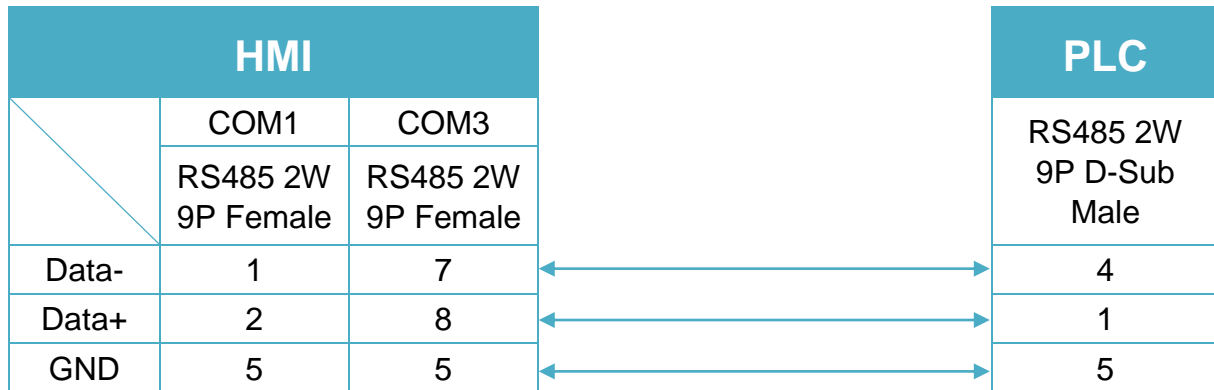
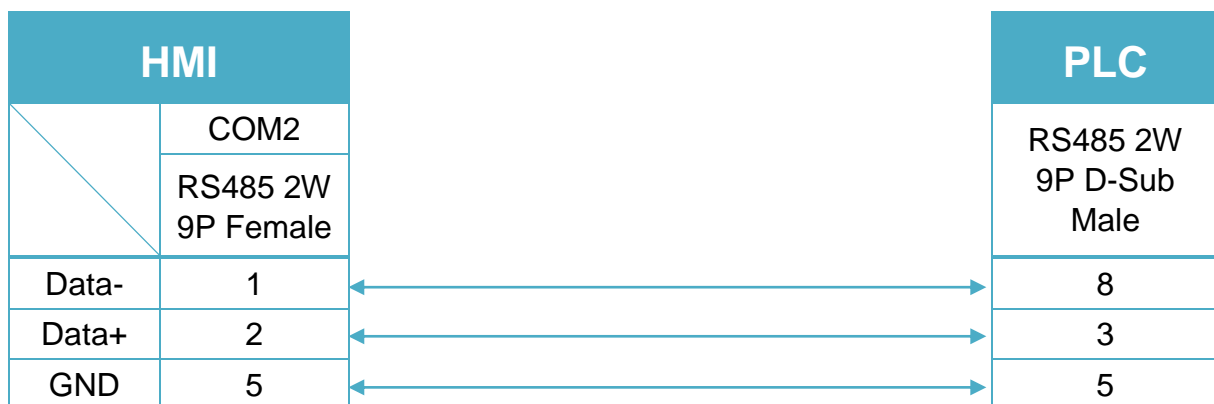


Diagram 9

MT-iP *MT6071iP / MT8071iP*



TECHSOFT Intelligent Servo

Supported Series: Intelligent Servo supports IDM640, IDM240.

Website: <http://www.techsoftmotion.com>

HMI Setting:

Parameters	Recommended	Options	Notes
PLC type	Intelligent Servo		
PLC I/F	RS232		
Baud rate	9600	9600~115200	
Data bits	8	7 or 8	
Parity	None	Even, Odd, None	
Stop bits	1	1 or 2	
PLC sta. no.	1		

Device Address:

Bit/Word	Device type	Format	Range	Memo
W	Register_32bit	HHHH	0 ~ 270f	32bit signed
DW	Register_H	HHHH	0 ~ 270f	32bit Hex
W	UPD	HHHHH	0 ~ 1869f	Send UDP command
W	STOP	HHHHH	0 ~ 1869f	Send STOP command

Wiring Diagram:

RS-232 6P Mini-Din (Diagram1 ~ Diagram 3)

Diagram 1

cMT Series	<i>cMT3151</i>
eMT Series	<i>eMT3070 / eMT3105 / eMT3120 / eMT3150</i>
MT-iE	<i>MT8073iE / MT8102iE</i>
MT-XE	<i>MT8092XE</i>
MT-iP	<i>MT6103iP</i>

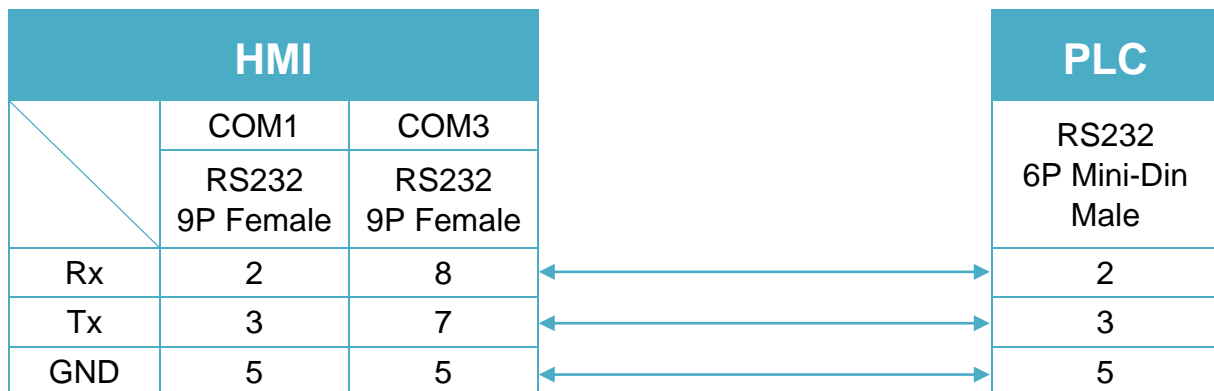


Diagram 2

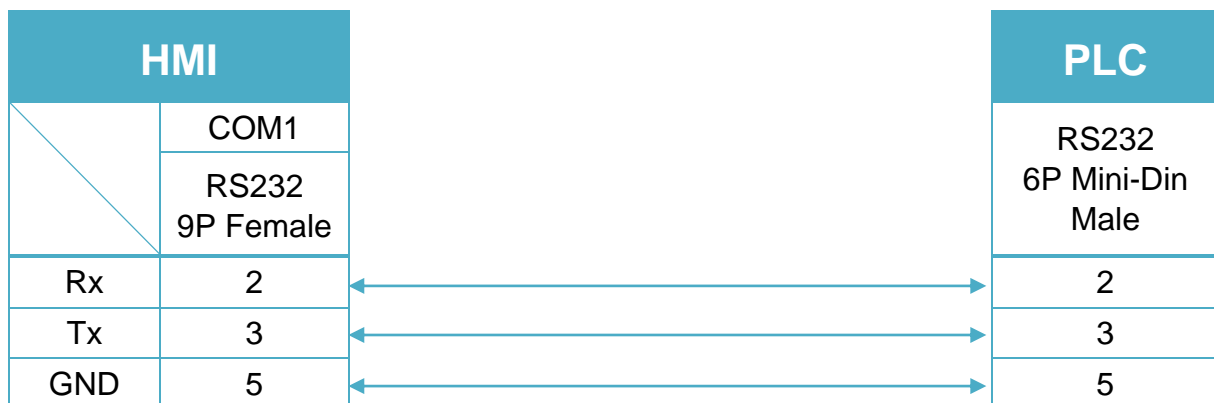
cMT Series
cMT-SVR
mTV
mTV
MT-iE
***MT8070iE / MT6070iE / MT8100iE / MT8121iE / MT8150iE /
MT8071iE / MT6071iE / MT8072iE / MT6072iE / MT8073iE /
MT8101iE / MT8102iE / MT8103iE***
MT-XE
MT8121XE / MT8150XE / MT8090XE


Diagram 3
MT-iE
MT8050iE
MT-iP
MT6051iP / MT6071iP / MT8071iP


TECO Inverter

Supported Series: TECO Inverter series, 7300CV model.

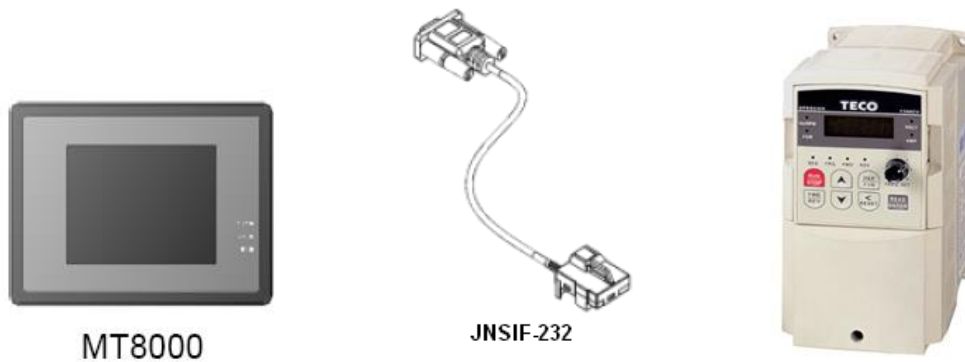
HMI Setting:

Parameters	Recommended	Options	Notes
PLC type	TECO Inverter		
PLC I/F	RS232	RS232/RS485	
Baud rate	38400		
Data bits	8		
Parity	None		
Stop bits	1		
PLC sta. no.	1		

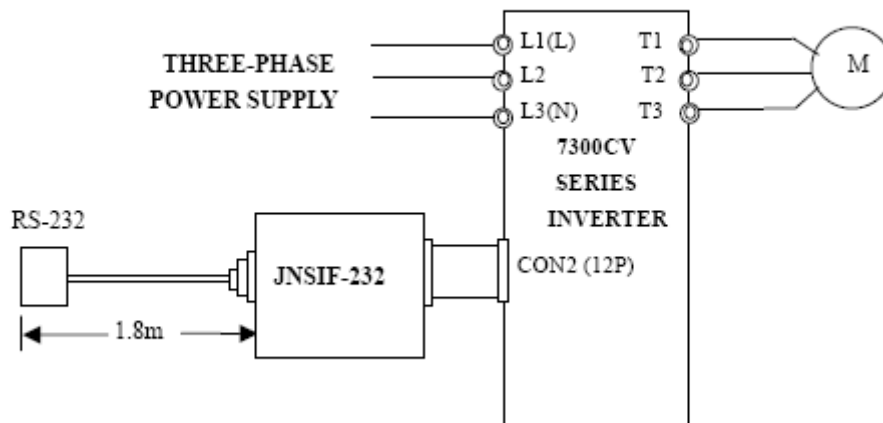
Device Address:

Bit/Word	Device	Format	Range	Memo
B	0x	DDDDD	1 ~ 65535	Output Bit
B	1x	DDDDD	1 ~ 65535	Input Bit (read only)
B	3x_Bit	DDDDDdd	100 ~ 6553515	Input Register Bit (read only)
B	4x_Bit	DDDDDdd	100 ~ 6553515	Output Register Bit
B	6x_Bit	DDDDDdd	100 ~ 6553515	
B	0x (0x0f)	DDDDD	1 ~ 65535	Write Multiple Coils
W	3x	DDDDD	1 ~ 65535	Input Register (read only)
W	4x	DDDDD	1 ~ 65535	Output Register
DW	5x	DDDDD	1 ~ 65535	4x Double Word Swap
W	6x	DDDDD	1 ~ 65535	4x Single Word Write

Wiring Diagram:



JNSIF-232 Wiring Diagram:

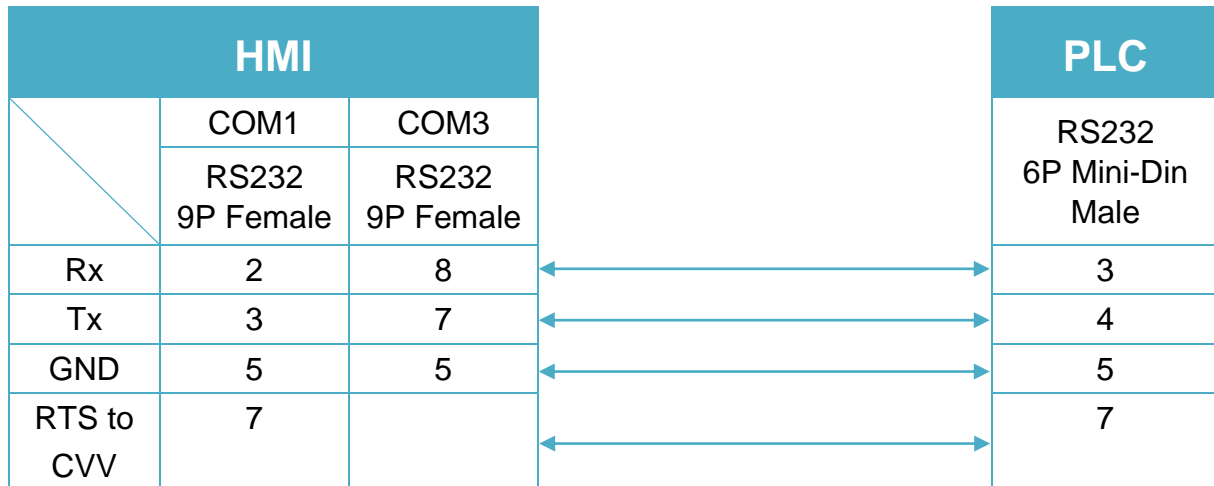


This section needs to double check as it doesn't have female in the original file.

RS-232 6P D-Sub (Diagram 1 ~ Diagram 3)

Diagram 1

cMT Series	cMT3151
eMT Series	eMT3070 / eMT3105 / eMT3120 / eMT3150
MT-iE	MT8073iE / MT8102iE
MT-XE	MT8092XE
MT-iP	MT6103iP


Diagram 2

cMT Series	cMT-SVR
mTV	mTV
MT-iE	MT8070iE / MT6070iE / MT8100iE / MT8121iE / MT8150iE / MT8071iE / MT6071iE / MT8072iE / MT6072iE / MT8073iE / MT8101iE / MT8102iE / MT8103iE
MT-XE	MT8121XE / MT8150XE / MT8090XE

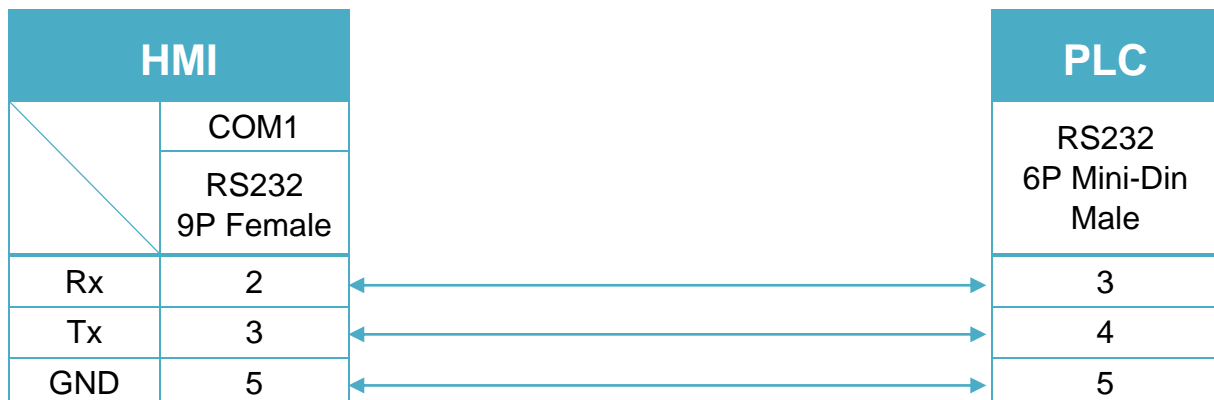


Diagram 3
MT-iE
MT8050iE
MT-iP
MT6051iP / MT6071iP / MT8071iP


TECO TP02 Series

Supported Series: TAIAN TP02 series

Website: <http://www.taian-technology.com>

HMI Setting:

Parameters	Recommended	Options	Notes
PLC type	TECO TP02 Series		
PLC I/F	RS485 4W/2W	RS485 4W/2W	MMI 422 port: 4W; RS485 terminals: 2W
Baud rate	19200	9600, 19200, 38400	
Data bits	7	7, 8	
Parity	Even	Even, Odd, None	
Stop bits	2	1, 2	
PLC sta. no.	1	0-255	

PLC Setting:

RS422 port: WS041=120, WS042=1;

RS485 terminals: WS044=120, WS045=1.

Device Address:

Bit/Word	Device type	Format	Range	Memo
B	X	DDD	1 ~ 384	Input relay
B	Y	DDD	1 ~ 384	Output relay
B	C	DDDD	1 ~ 2048	Auxiliary relay
W	XW	DDD	1 ~ 369	Input register (must be 1 or a multiple of plus 1)
W	YW	DDD	1 ~ 369	Output register (must be 1 or a multiple of plus 1)
W	V	DDDD	1 ~ 1024	Auxiliary register
W	D	DDDD	1 ~ 2048	Auxiliary register
W	WS	DDD	1 ~ 128	System register
W	C	DDDD	1 ~ 2033	Auxiliary relay register (must be 1 or a multiple of plus 1)
W	WC	DDD	1 ~ 912	Constant register

Wiring Diagram:

RS-485 4W Terminal (Diagram1 ~ Diagram 4)

Diagram 1

cMT Series	<i>cMT3151</i>
eMT Series	<i>eMT3070 / eMT3105 / eMT3120 / eMT3150</i>
MT-iE	<i>MT8070iE / MT6070iE / MT8100iE / MT8121iE / MT8150iE</i>
MT-XE	<i>MT8121XE / MT8150XE</i>

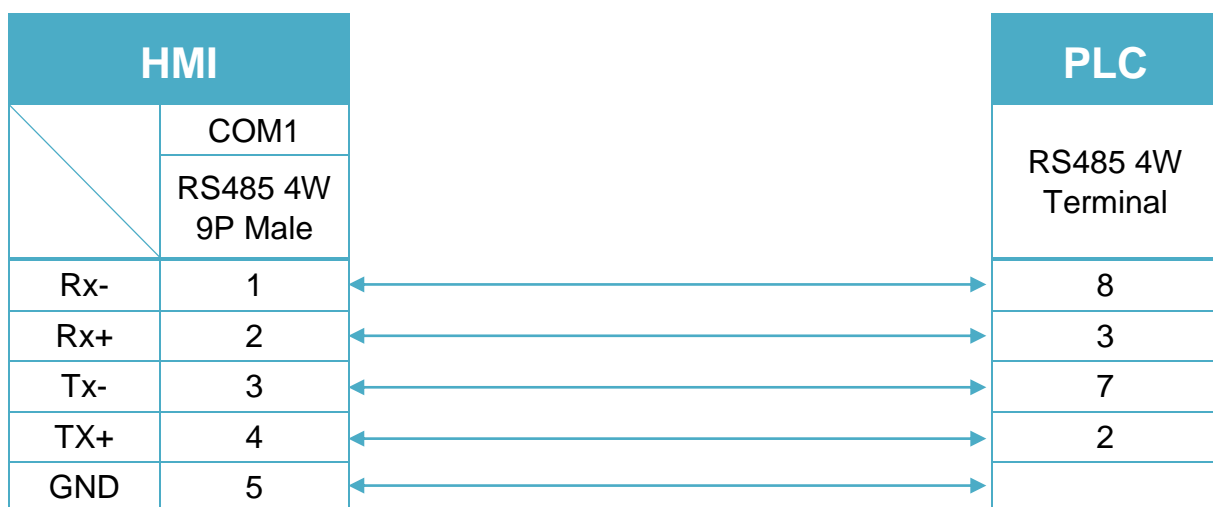


Diagram 2

cMT Series	<i>cMT-SVR</i>
mTV	<i>mTV</i>

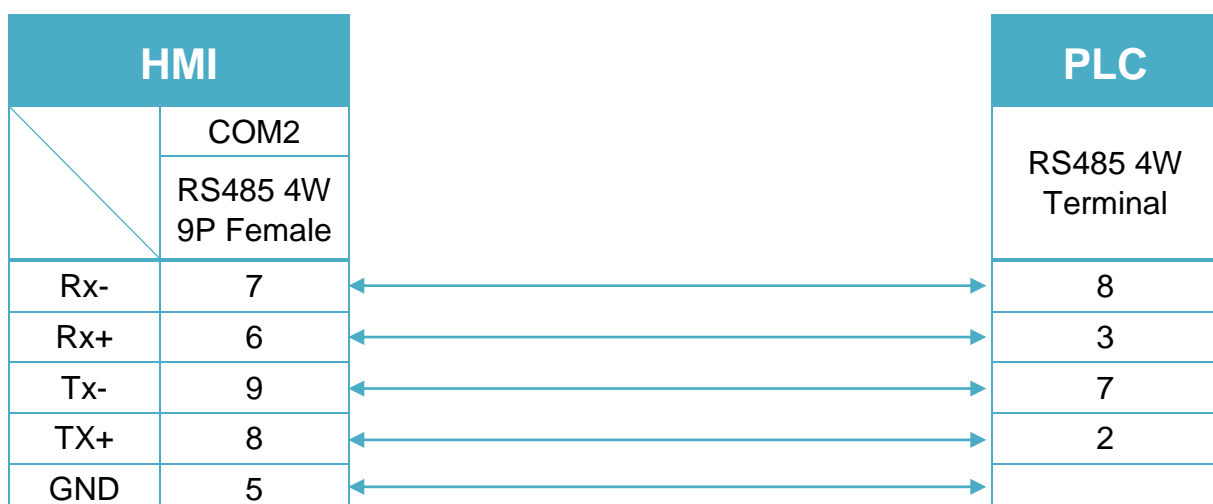


Diagram 3

MT-iE	<i>MT8071iE / MT6071iE / MT8072iE / MT6072iE / MT8073iE / MT8101iE / MT8102iE / MT8103iE</i>
MT-XE	<i>MT8090XE / MT8092XE</i>
MT-iP	<i>MT6071iP / MT8071iP / MT6103iP</i>

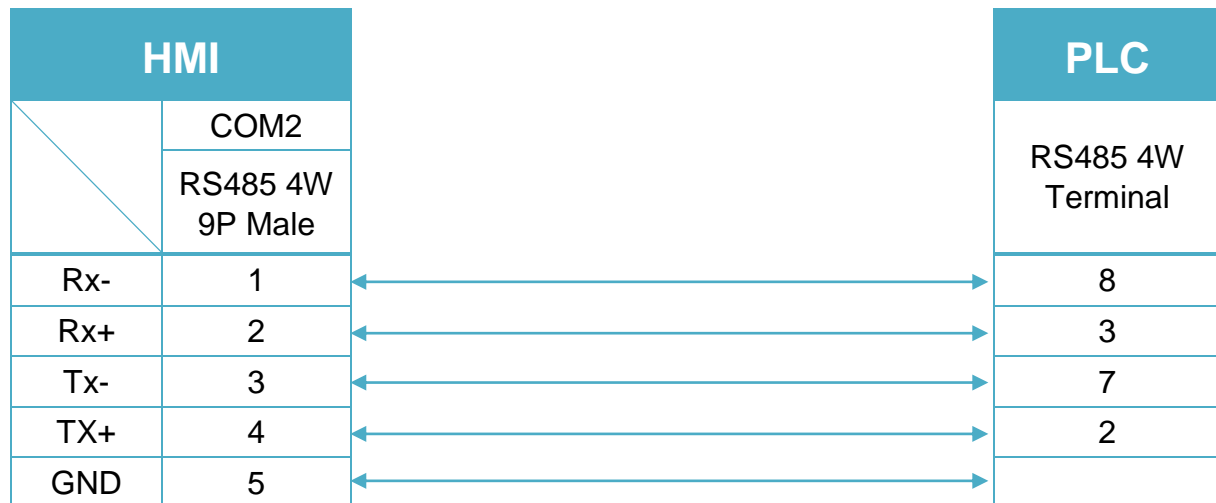
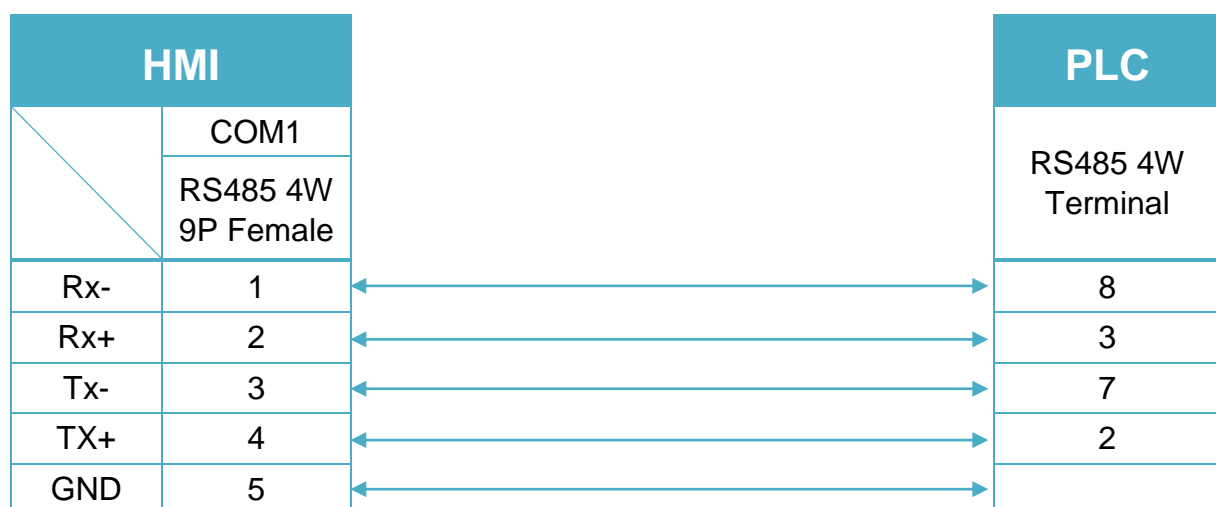


Diagram 4

MT-iE	<i>MT8050iE</i>
MT-iP	<i>MT6051iP</i>



RS 485 2W Terminal (Diagram5 ~ Diagram10)

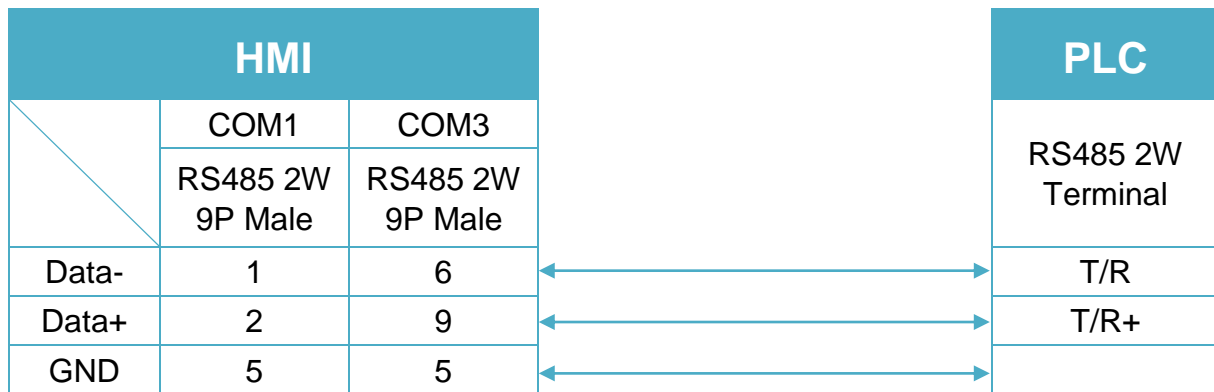
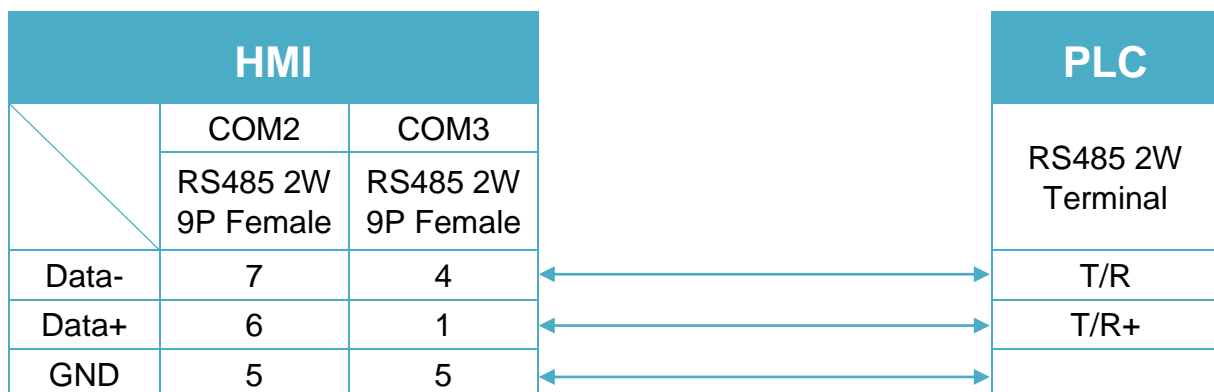
Diagram 5
cMT Series
cMT3151
eMT Series
eMT3070 / eMT3105 / eMT3120 / eMT3150

Diagram 6
cMT Series
cMT-SVR
mTV
mTV


Diagram 7

MT-iE *MT8070iE / MT6070iE / MT8100iE / MT8121iE / MT8150iE*

MT-XE *MT8121XE / MT8150XE*

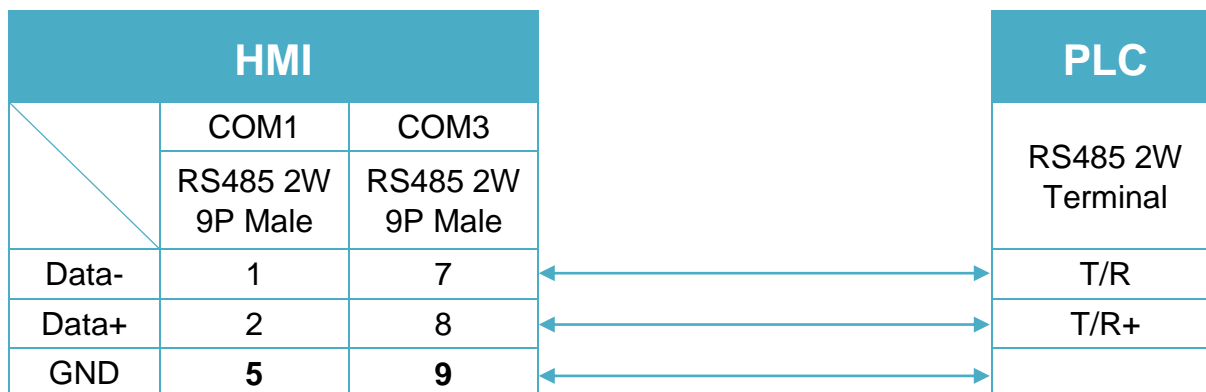


Diagram 8

MT-iE *MT8071iE / MT6071iE / MT8072iE / MT6072iE / MT8073iE /
MT8101iE / MT8102iE / MT8103iE*

MT-XE *MT8090XE / MT8092XE*

MT-iP *MT6103iP*

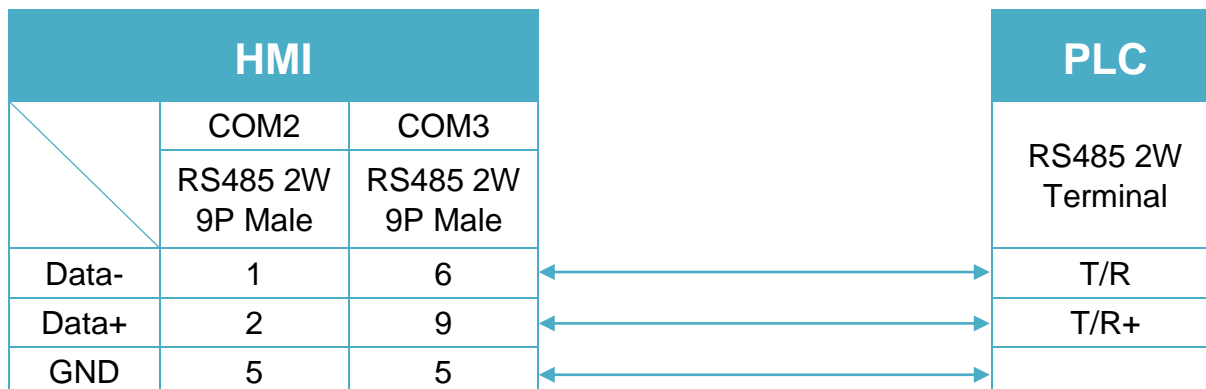
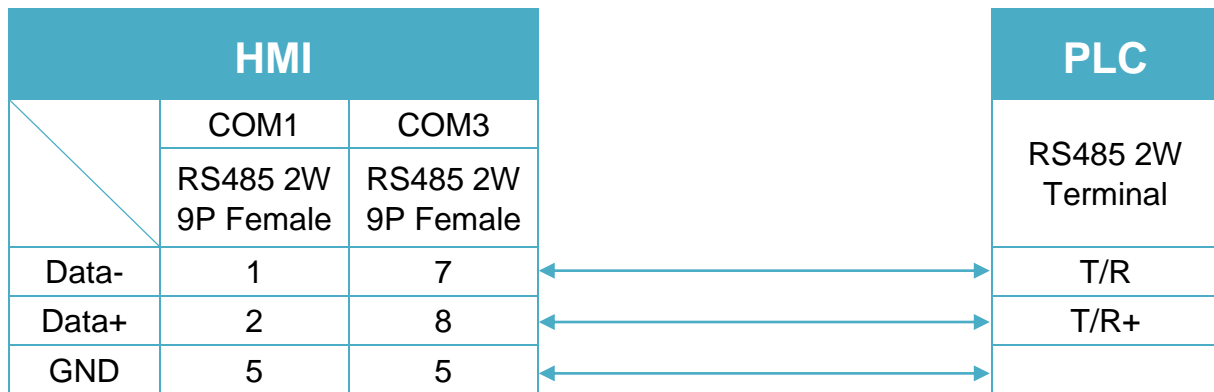


Diagram 9
MT-iE *MT8050iE*
MT-iP *MT6051iP*

Diagram 10
MT-iP *MT6071iP / MT8071iP*


TECO TP03 Series/AP-360BT-A

Supported Series: TECO TP03 Series/AP-360BT-A

Website: <http://www.teco.com.tw/sa/en/>

HMI Setting:

Parameters	Recommended	Options	Notes
PLC type	TECO TP03 Series/AP-360BT-A		
PLC I/F	RS485 4W		
Baud rate	19200	9600, 19200	
Data bits	8	8	
Parity	None	Even, Odd, None	
Stop bits	2	1	
PLC sta. no.	1	1-255	

Device Address:

Bit/Word	Device type	Format	Range	Memo
B	C	DDDD	0 ~ 9999	
B	C256	DDDD	256 ~ 9999	
B	M	DDDD	0 ~ 9999	
B	S	DDDD	0 ~ 9999	
B	T	DDDD	0 ~ 9999	
B	X	OOO	0 ~ 377	
B	Y	OOO	0 ~ 377	
W	D	DDDD	0 ~ 9999	
W	V	DDDD	0 ~ 9999	
W	Z	DDDD	0 ~ 9999	
W	T_Curent	DDDD	0 ~ 9999	
W	C_Curent	DDDD	0 ~ 9999	
W	T_Preset	DDDD	0 ~ 9999	
W	C_Preset	DDDD	0 ~ 9999	
DW	C200_Curent	DDDD	200 ~ 9999	
DW	C200_Preset	DDDD	200 ~ 9999	
DW	C256_Curent	DDDD	256 ~ 9999	
DW	C256_Preset	DDDD	256 ~ 9999	

Wiring Diagram:

The following is the view from the soldering point of a connector.



RS-485 4W 8P Mini-Din (Diagram1 ~ Diagram4)

Diagram 1

cMT Series	<i>cMT3151</i>
eMT Series	<i>eMT3070 / eMT3105 / eMT3120 / eMT3150</i>
MT-iE	<i>MT8070iE / MT6070iE / MT8100iE / MT8121iE / MT8150iE</i>
MT-XE	<i>MT8121XE / MT8150XE</i>

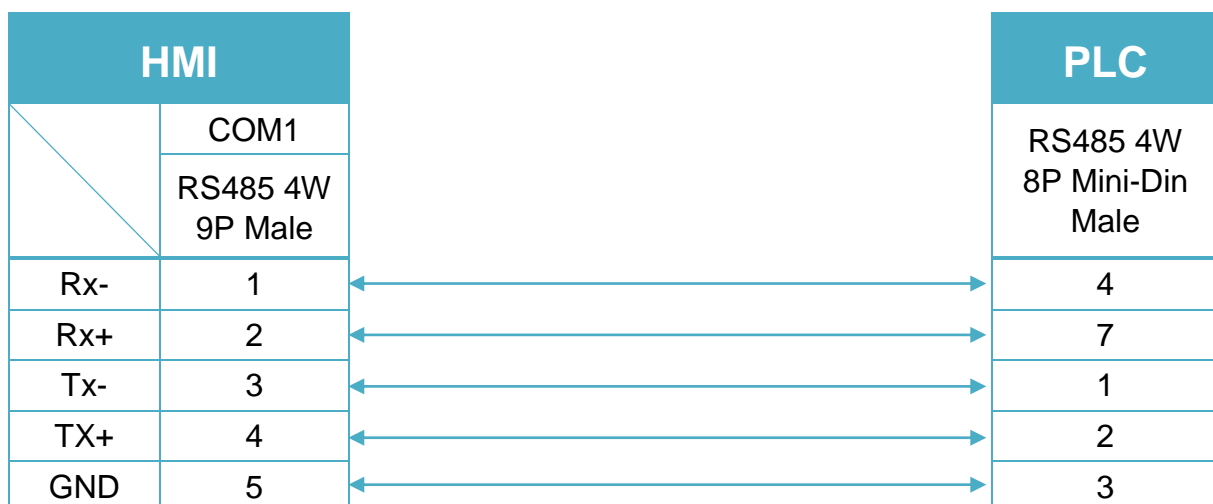


Diagram 2

cMT Series *cMT-SVR*

mTV *mTV*

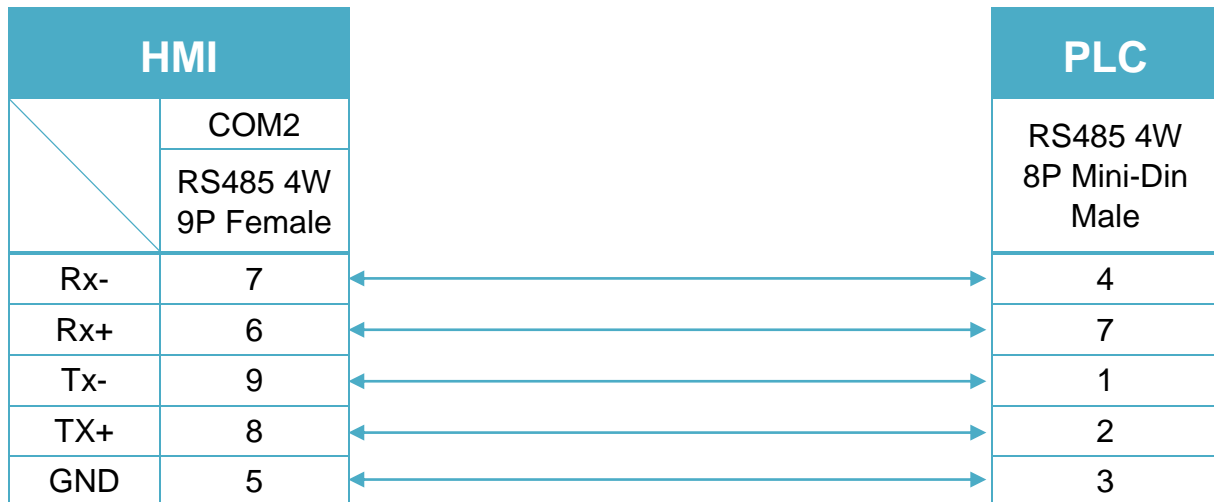


Diagram 3

MT-iE *MT8071iE / MT6071iE / MT8072iE / MT6072iE / MT8073iE /
MT8101iE / MT8102iE / MT8103iE*

MT-XE *MT8090XE / MT8092XE*

MT-iP *MT6071iP / MT8071iP / MT6103iP*

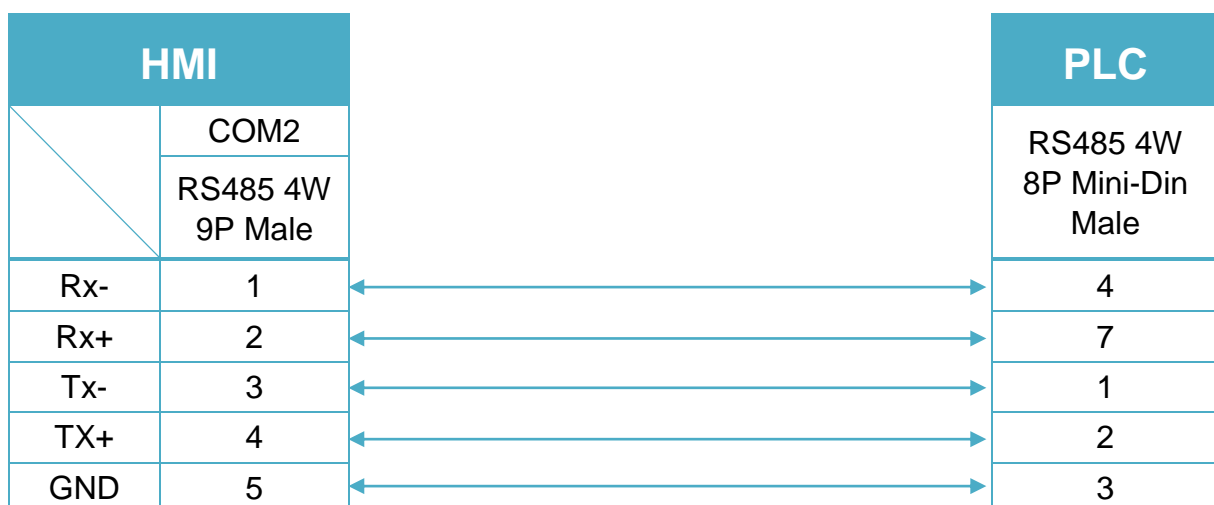
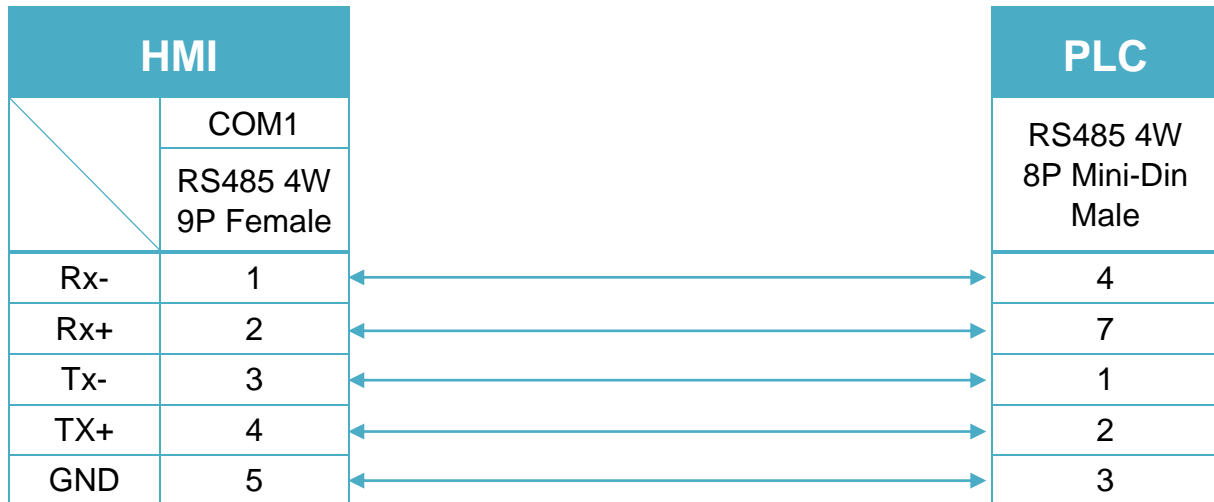


Diagram 4
MT-iE *MT8050iE*
MT-iP *MT6051iP*


TINHAO

Website: www.chinastrand.com

HMI Setting:

Parameters	Recommended	Options	Notes
PLC type	TINHAO		
PLC I/F	RS485 2W		
Baud rate	19200		
Data bits	8		
Parity	None		
Stop bits	1		
PLC sta. no.	1		

Device Address:

Bit/Word	Device type	Format	Range	Memo
W	Commend1	DDD	0 ~ 255	
W	Commend2	DDD	0 ~ 255	
W	Commend3	DDD	0 ~ 255	
W	Commend4	DDD	0 ~ 255	
W	Commend5	DDD	0 ~ 255	
W	Commend6	DDD	0 ~ 255	
W	Commend7	DDD	0 ~ 255	
W	Commend8	DDD	0 ~ 255	
W	Commend9	DDD	0 ~ 255	
W	Commend10	DDD	0 ~ 255	
W	Commend11	DDD	0 ~ 255	
W	Commend12	DDD	0 ~ 255	
W	Commend13	DDD	0 ~ 255	
W	Commend14	DDD	0 ~ 255	
W	Commend15	DDD	0 ~ 255	
W	Commend16	DDD	0 ~ 255	
W	Commend17	DDD	0 ~ 255	
W	Commend18	DDD	0 ~ 255	
W	Commend19	DDD	0 ~ 255	
W	Commend20	DDD	0 ~ 255	
W	Commend21	DDD	0 ~ 255	
W	Commend22	DDD	0 ~ 255	

Wiring Diagram:

RS-485 2W Terminal (Diagram1 ~ Diagram6)

Diagram 1

cMT Series

cMT3151

eMT Series

eMT3070 / eMT3105 / eMT3120 / eMT3150

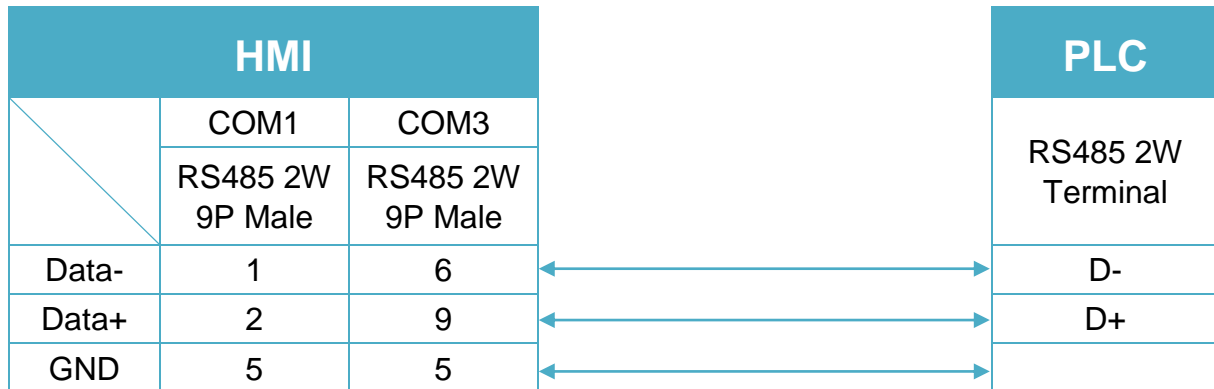


Diagram 2

cMT Series

cMT-SVR

mTV

mTV

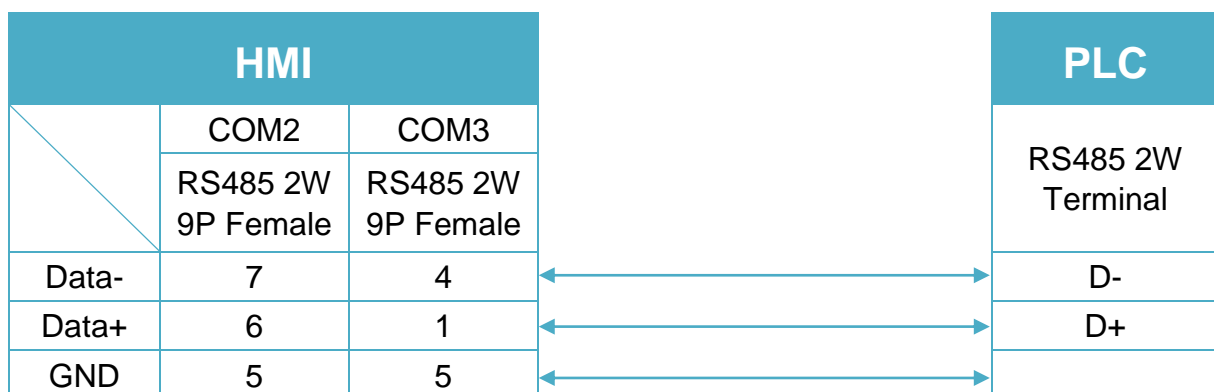


Diagram 3

MT-iE *MT8070iE / MT6070iE / MT8100iE / MT8121iE / MT8150iE*

MT-XE *MT8121XE / MT8150XE*

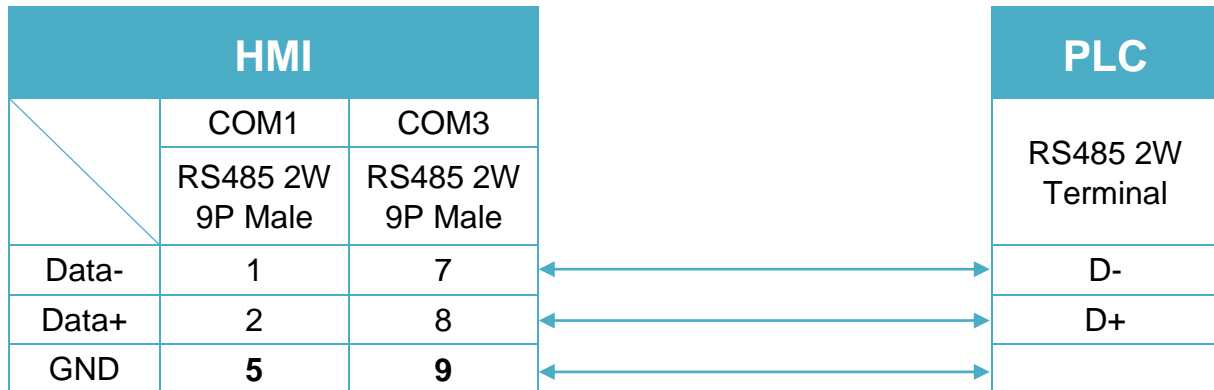


Diagram 4

MT-iE *MT8071iE / MT6071iE / MT8072iE / MT6072iE / MT8073iE / MT8101iE / MT8102iE / MT8103iE*

MT-XE *MT8090XE / MT8092XE*

MT-iP *MT6103iP*

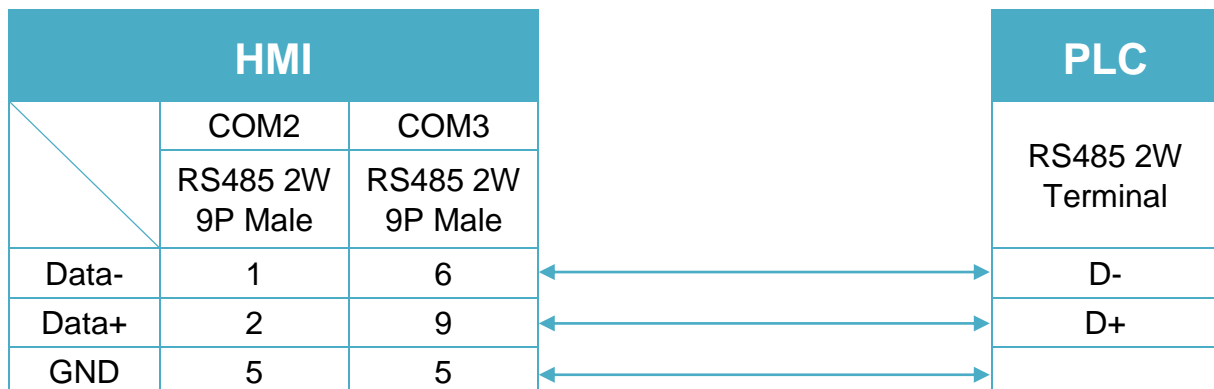
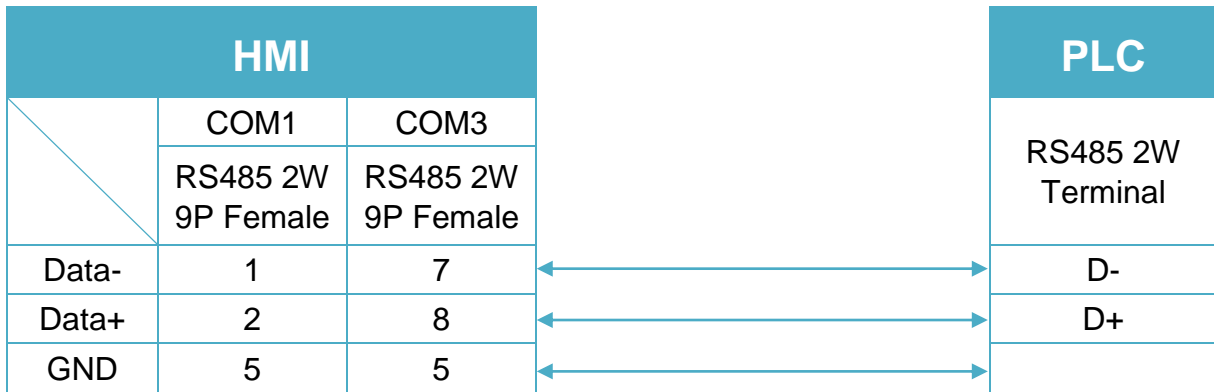


Diagram 5
MT-iE *MT8050iE*
MT-iP *MT6051iP*

Diagram 6
MT-iP *MT6071iP / MT8071iP*


Toptek Topvert

Supported Series: TOPVERT G1/H1/P1 series.

Website: <http://www.toptek.biz/>

HMI Setting:

Parameters	Recommended	Options	Notes
PLC type	Toptek Topvert		
PLC I/F	RS485 2W		
Baud rate	9600		
Data bits	7		
Parity	None		
Stop bits	2		
PLC sta. no.	1		

Online simulator	YES	Broadcast command	YES
Extend address mode	YES	Broadcast station no.	0

PLC Setting:

Communication mode	Pr 7-15 = 0 (7, N, 2 ASCII)
---------------------------	-----------------------------

Device Address:

Bit/Word	Device type	Format	Range	Memo
B	PR_Bit	DDDDDDdd	0 ~ 6553515	G=Groups, F=Function no. dd=0~15 bit no.
W	PR	DDDDD	0 ~ 65535	G=Groups, F=Function no.

Note:

Max.read-command size (words): 16

Max.write-command size (words): 1

For G1/H1/P1 Series Inverter, if standard parameter address is in decimal= $100 \times G + F$:

G=Group (parameter group code 0~9); F=Function no. (parameter number 0~99)

For example: Pr5-20 (decimal Dec.) parameter address is expressed as $100 \times 5 + 20 = 520$.

Parameter (PrX-XX)	Address (decimal)
0-00	$0 \times 100 + 0 = 0$
0-14	$0 \times 100 + 14 = 14$
1-00	$1 \times 100 + 0 = 100$

Wiring Diagram:

RS-485 2W Terminal (Diagram1 ~ Diagram6)

Diagram 1

cMT Series

cMT3151

eMT Series

eMT3070 / eMT3105 / eMT3120 / eMT3150

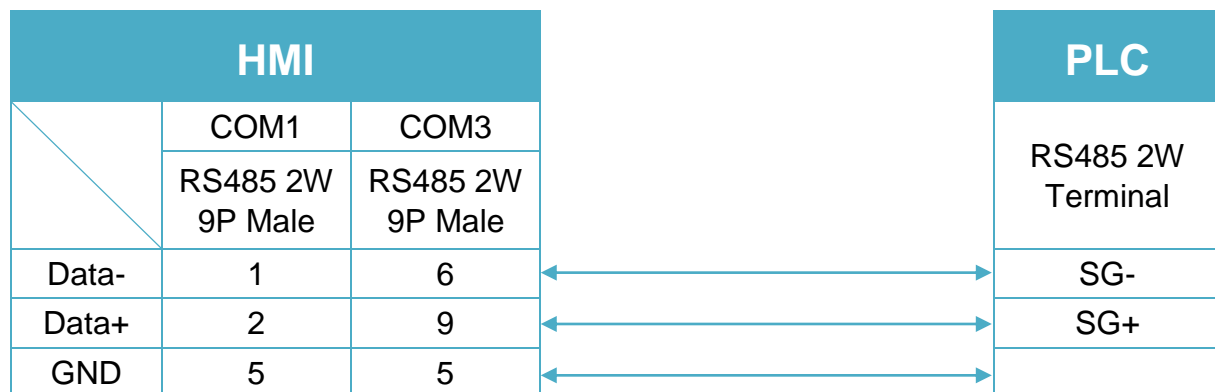


Diagram 2

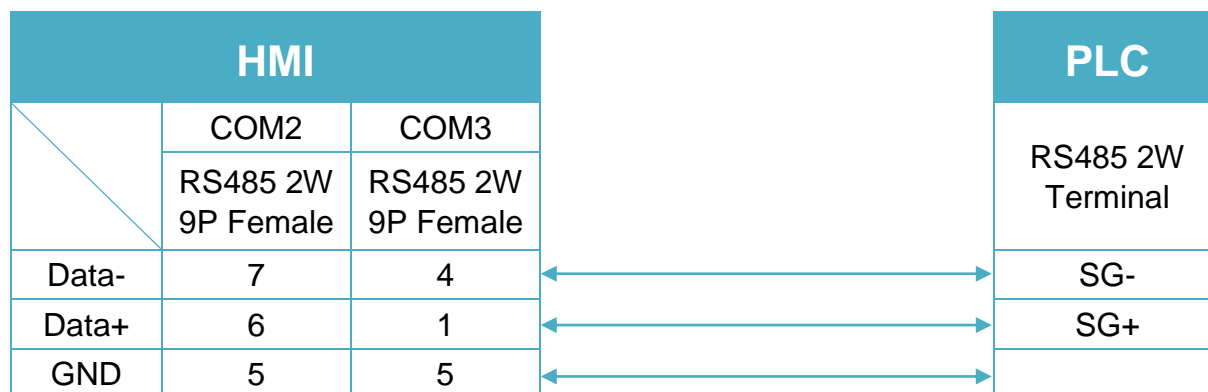
cMT Series
cMT-SVR
mTV
mTV


Diagram 3

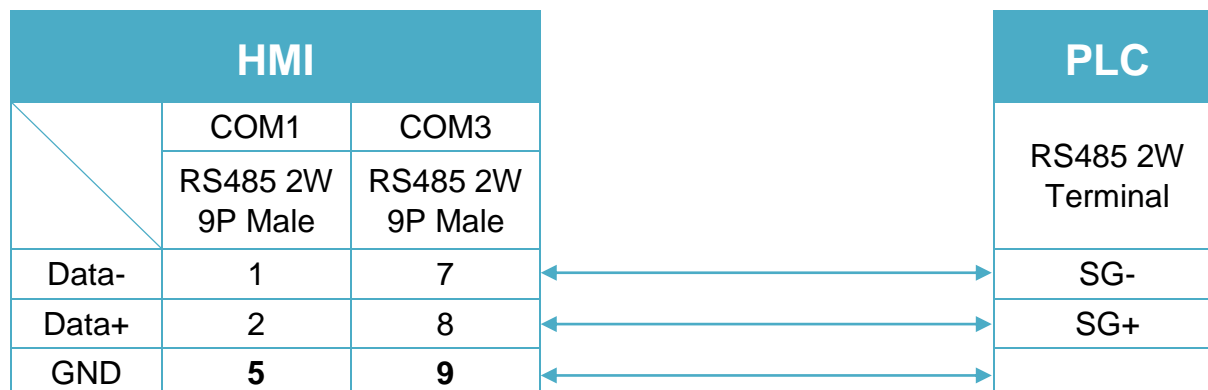
MT-iE
MT8070iE / MT6070iE / MT8100iE / MT8121iE / MT8150iE
MT-XE
MT8121XE / MT8150XE


Diagram 4

MT-iE	<i>MT8071iE / MT6071iE / MT8072iE / MT6072iE / MT8073iE / MT8101iE / MT8102iE / MT8103iE</i>
MT-XE	<i>MT8090XE / MT8092XE</i>
MT-iP	<i>MT6103iP</i>

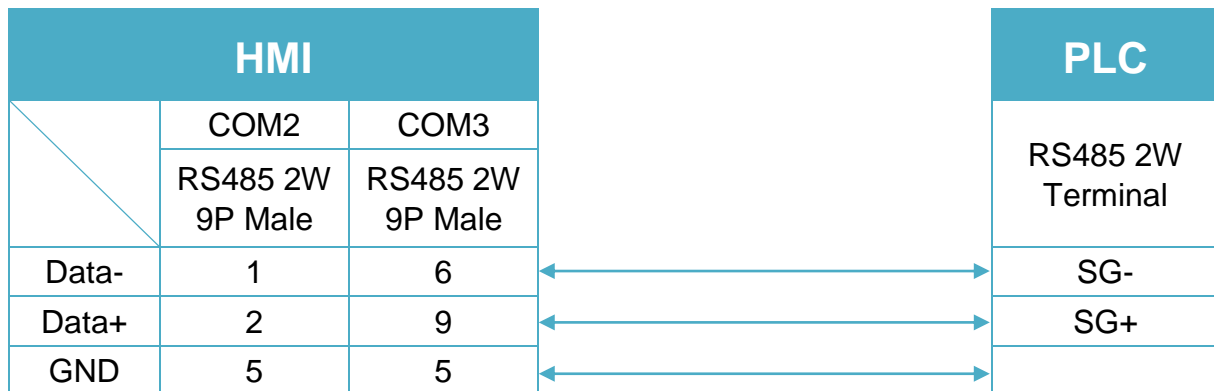


Diagram 5

MT-iE	<i>MT8050iE</i>
MT-iP	<i>MT6051iP</i>

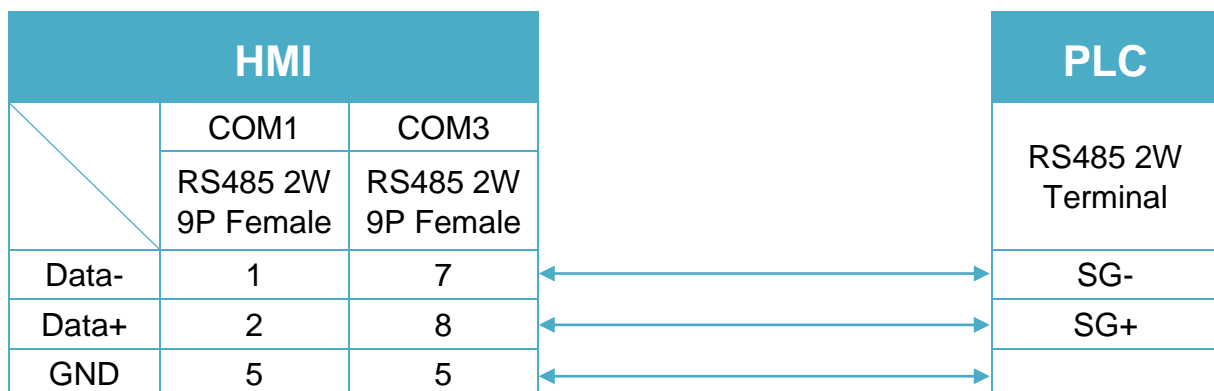


Diagram 6

MT-iP
MT6071iP / MT8071iP


TOSHIBA INVERTER VF

Supported Series: Toshiba Invertor Protocol (ASCII code).

HMI Setting:

Parameters	Recommended	Options	Notes
PLC type	TOSHIBA INVERTER VF		
PLC I/F	RS485 2W	RS422, RS485	
Baud rate	9600	9600, 19200	
Data bits	8	7 or 8	
Parity	Even	Even, Odd, None	
Stop bits	1	1 or 2	
PLC sta. no.	0	0-99	

Online simulator	YES	Extend address mode	YES
Broadcast command	YES		

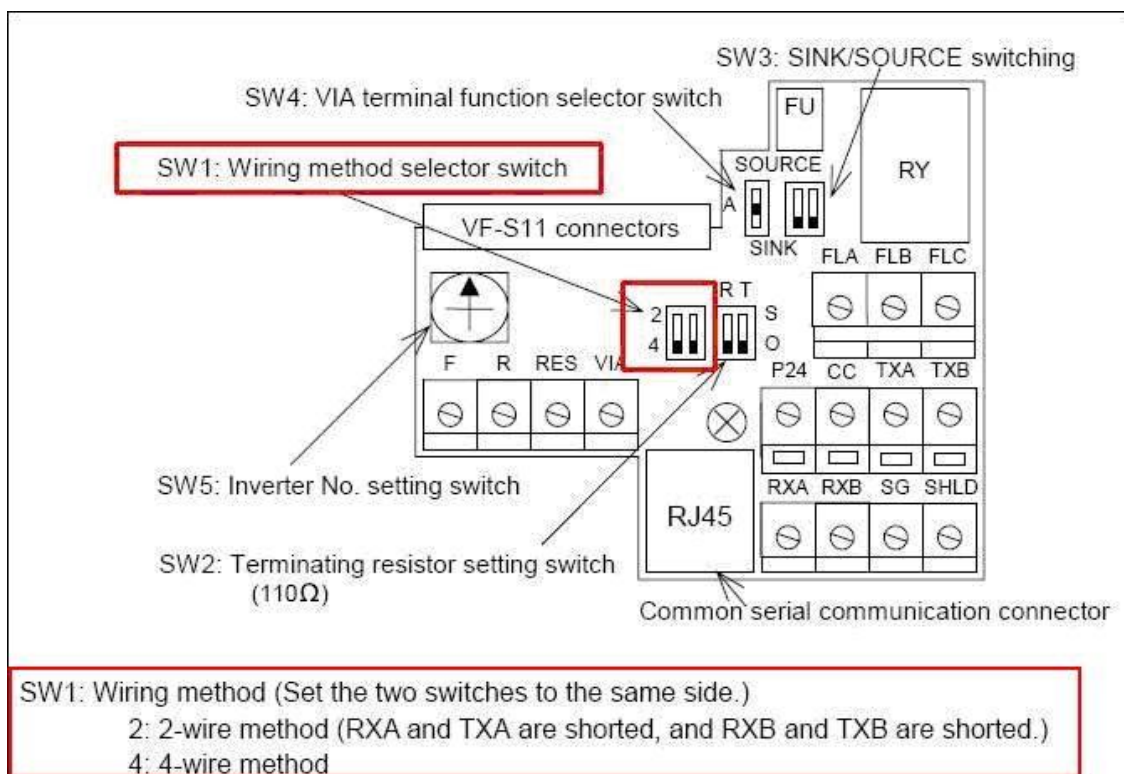
Device Address:

Bit/Word	Device type	Format	Range	Memo
B	Cmd. No B	HHHHdd	0 ~ 270f15	
W	Cmd. No	HHHH	0 ~ ffff	Parameters and data memory

Wiring Diagram:

Note:

Before connecting with TOSHIBA INVERTER VF, make sure the SW1 of both sides are in the correct position. (SW1: wiring method selector switch)



RS 485 2W 8P RJ45 (Diagram1 ~ Diagram 6)

Diagram 1

cMT Series

cMT3151

eMT Series

eMT3070 / eMT3105 / eMT3120 / eMT3150

HMI			PLC
	COM1	COM3	
	RS485 2W 9P Male	RS485 2W 9P Male	RS485 2W 8P RJ45 Male
Data-	1	6	5 Data+
Data+	2	9	4 Data-
GND	5	5	8 Gnd

Diagram 2

cMT Series *cMT-SVR*

mTV *mTV*

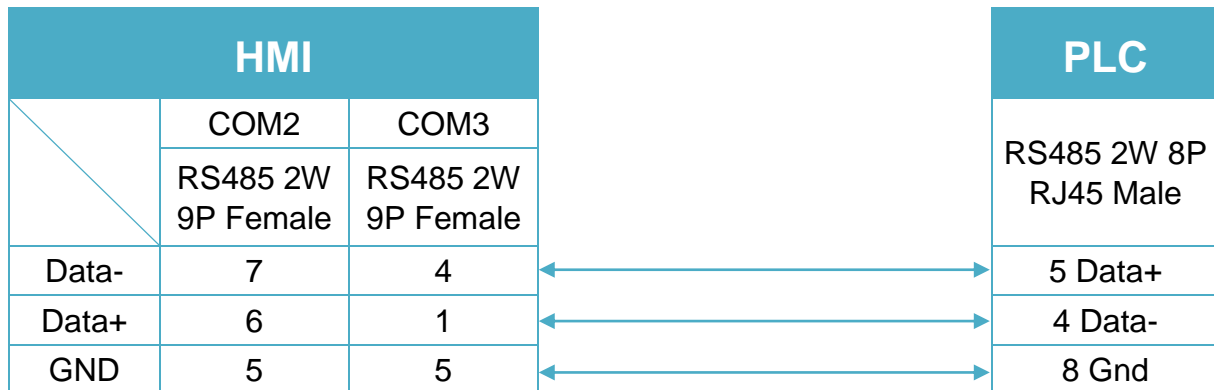


Diagram 3

MT-iE *MT8070iE / MT6070iE / MT8100iE / MT8121iE / MT8150iE*

MT-XE *MT8121XE / MT8150XE*

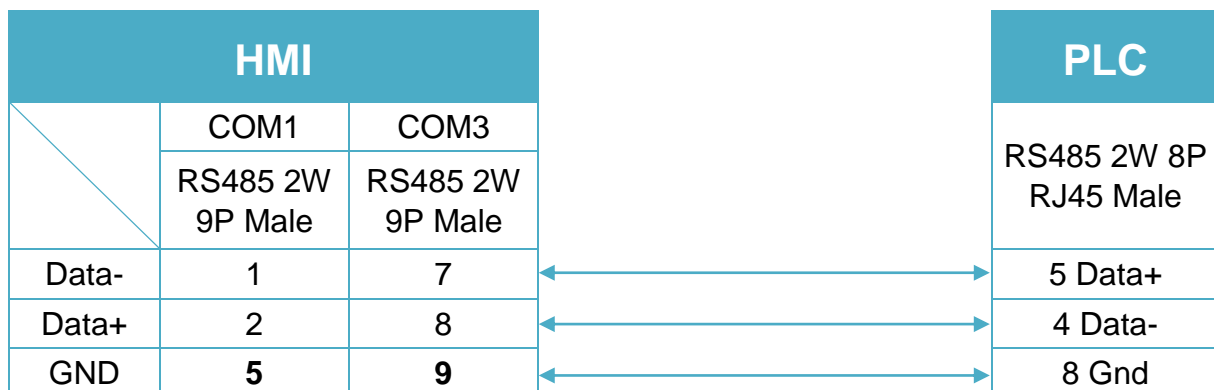
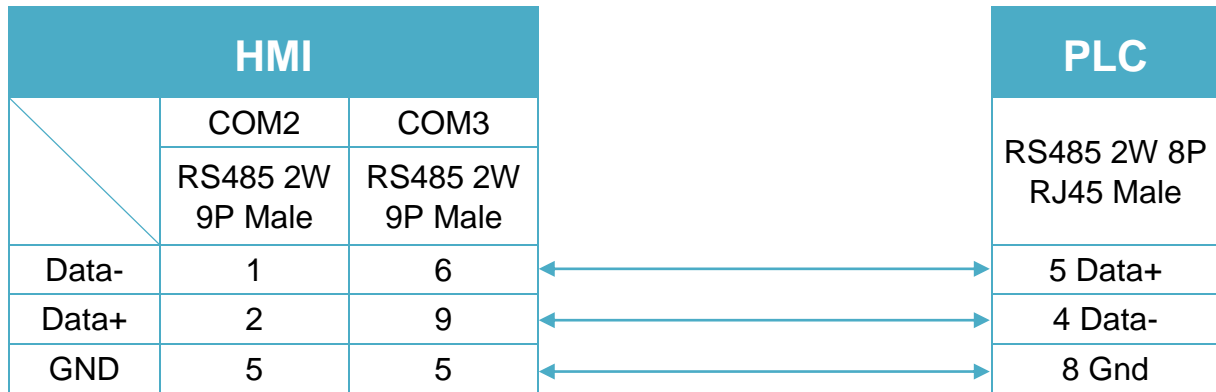
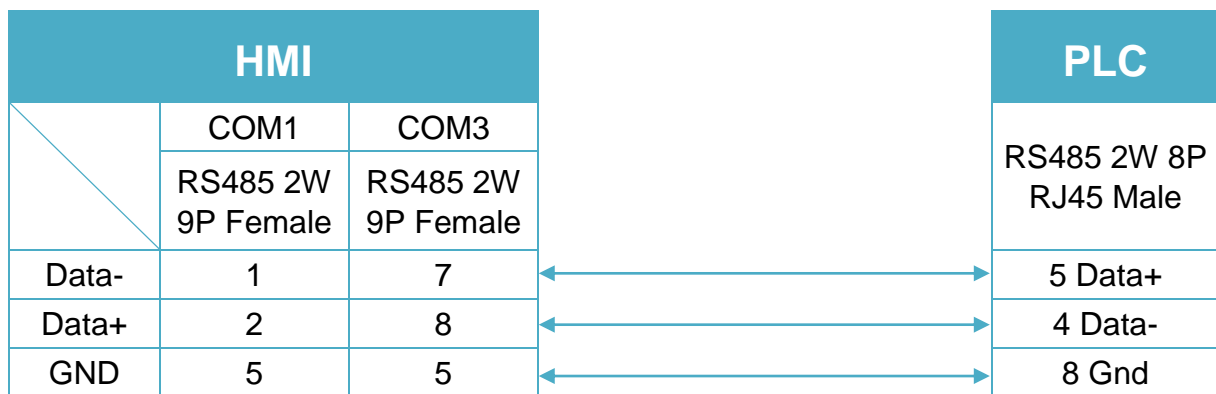
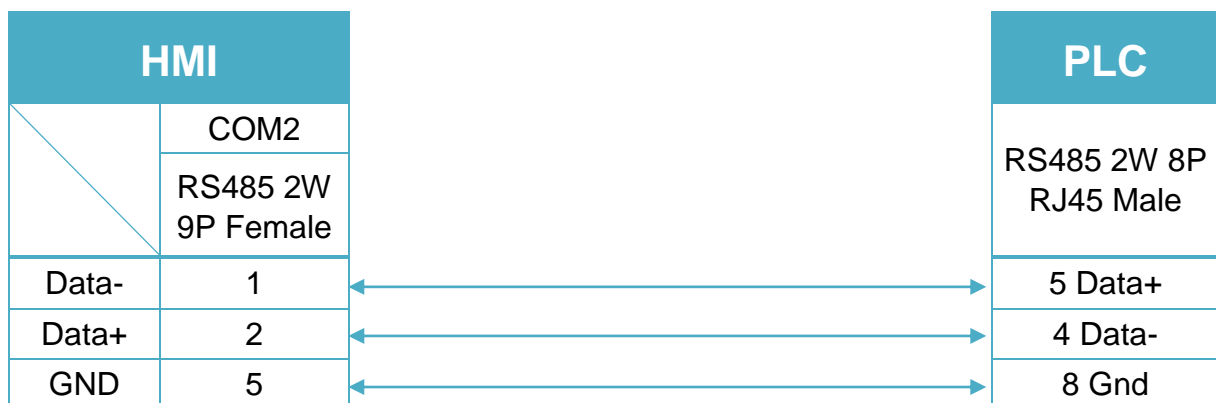


Diagram 4

MT-iE *MT8071iE / MT6071iE / MT8072iE / MT6072iE / MT8073iE /
MT8101iE / MT8102iE / MT8103iE*

MT-XE *MT8090XE / MT8092XE*

MT-iP *MT6103iP*


Diagram 5
MT-iE *MT8050iE*
MT-iP *MT6051iP*

Diagram 6
MT-iP *MT6071iP / MT8071iP*


TOSHIBA T Series

Supported Series: Toshiba T series, S2E.

Website: <http://www.tic.toshiba.com>

HMI Setting:

Parameters	Recommended	Options	Notes
PLC type	TOSHIBA T Series		
PLC I/F	RS232	RS232/RS485	In accordance with PLC port
Baud rate	9600	9600, 19200, 38400, 57600, 115200	
Data bits	8	7,8	
Parity	Odd	Even, Odd, None	
Stop bits	1	1, 2	
PLC sta. no.	0	0-255	Must be same as the PLC setting

Online simulator	YES	Extend address mode	YES
-------------------------	-----	----------------------------	-----

PLC Setting:

Communication mode	Must set PLC node ID
---------------------------	----------------------

Device Address:

Bit/Word	Device	Format	Range	Memo
B	X	DDDDh	0 ~ 4095f	Input Bit
B	Y	DDDDh	0 ~ 4095f	Output Bit
B	R	DDDDh	0 ~ 8191f	Auxiliary Bit
B	S	DDDDh	0 ~ 4095f	Special Bit
B	L	DDDDh	0 ~ 4095f	
B	Z	DDDDh	0 ~ 8191f	
W	T	DDD	0 ~ 999	Timer Register
W	C	DDD	0 ~ 511	Counter Register
W	D	DDDD	0 ~ 8191	Data Memory
W	SW	DDD	0 ~ 255	Special Register
W	XW	DDD	0 ~ 255	Input Register
W	YW	DDD	0 ~ 255	Output Register

Bit/Word	Device	Format	Range	Memo
W	RW	DDD	0 ~ 999	Auxiliary Register
W	LW	DDD	0 ~ 255	
W	W	DDDD	0 ~ 1023	
W	F	DDDD	0 ~ 8191	

Wiring Diagram:

The following is the view from the soldering point of a connector.



RS-232 8P Mini-DIN (Diagram1 ~ Diagram3)

Diagram 1

cMT Series	<i>cMT3151</i>
eMT Series	<i>eMT3070 / eMT3105 / eMT3120 / eMT3150</i>
MT-iE	<i>MT8073iE / MT8102iE</i>
MT-XE	<i>MT8092XE</i>
MT-iP	<i>MT6103iP</i>

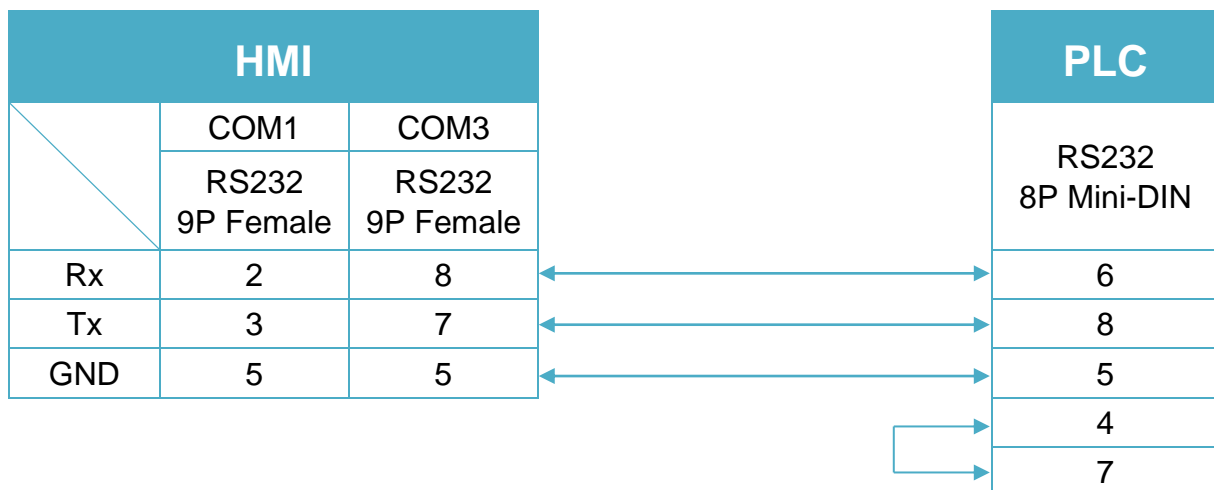


Diagram 2

cMT Series	cMT-SVR
mTV	mTV
MT-iE	MT8070iE / MT6070iE / MT8100iE / MT8121iE / MT8150iE / MT8071iE / MT6071iE / MT8072iE / MT6072iE / MT8073iE / MT8101iE / MT8102iE / MT8103iE
MT-XE	MT8121XE / MT8150XE / MT8090XE

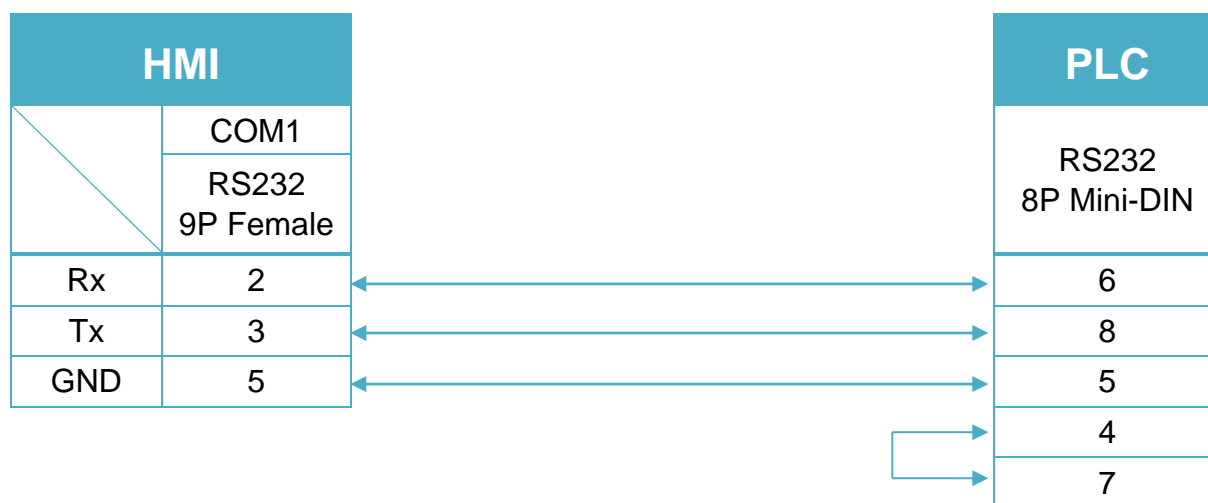
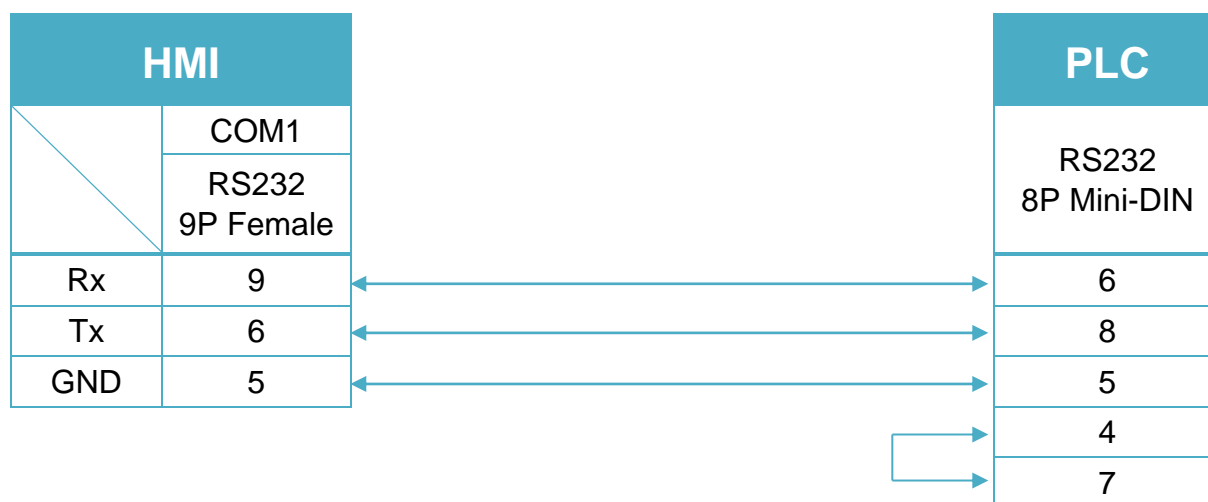


Diagram 3

MT-iE	MT8050iE
MT-iP	MT6051iP / MT6071iP / MT8071iP



RS-232 9P D-Sub (Diagram4 ~ Diagram 6)

Diagram 4

cMT Series	<i>cMT3151</i>
eMT Series	<i>eMT3070/ eMT3105 / eMT3120 / eMT3150</i>
MT-iE	<i>MT8073iE / MT8102iE</i>
MT-XE	<i>MT8092XE</i>
MT-iP	<i>MT6103iP</i>

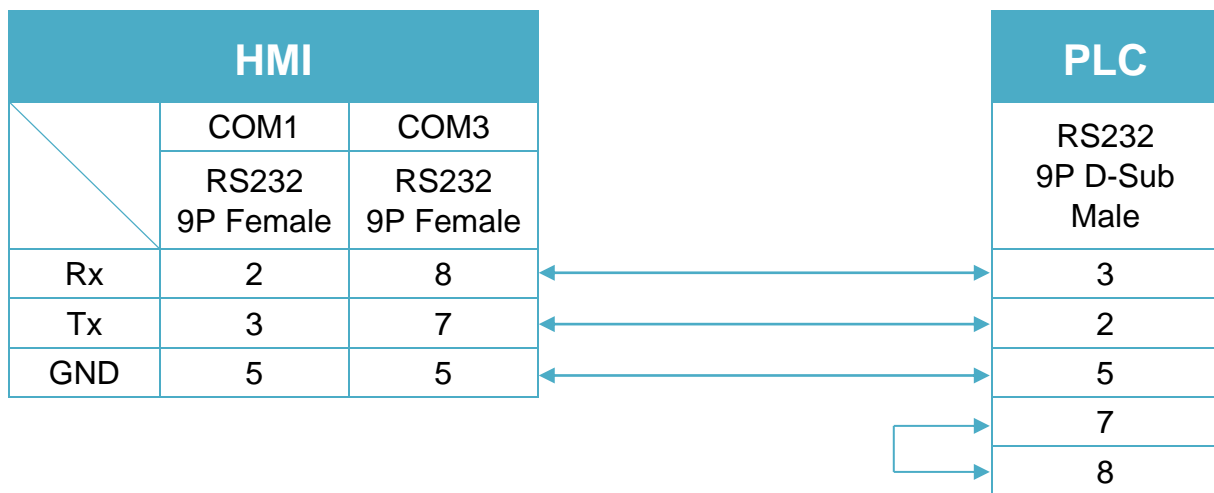


Diagram 5

cMT Series	cMT-SVR
mTV	mTV
MT-iE	MT8070iE / MT6070iE / MT8100iE / MT8121iE / MT8150iE / MT8071iE / MT6071iE / MT8072iE / MT6072iE / MT8073iE / MT8101iE / MT8102iE / MT8103iE
MT-XE	MT8121XE / MT8150XE / MT8090XE

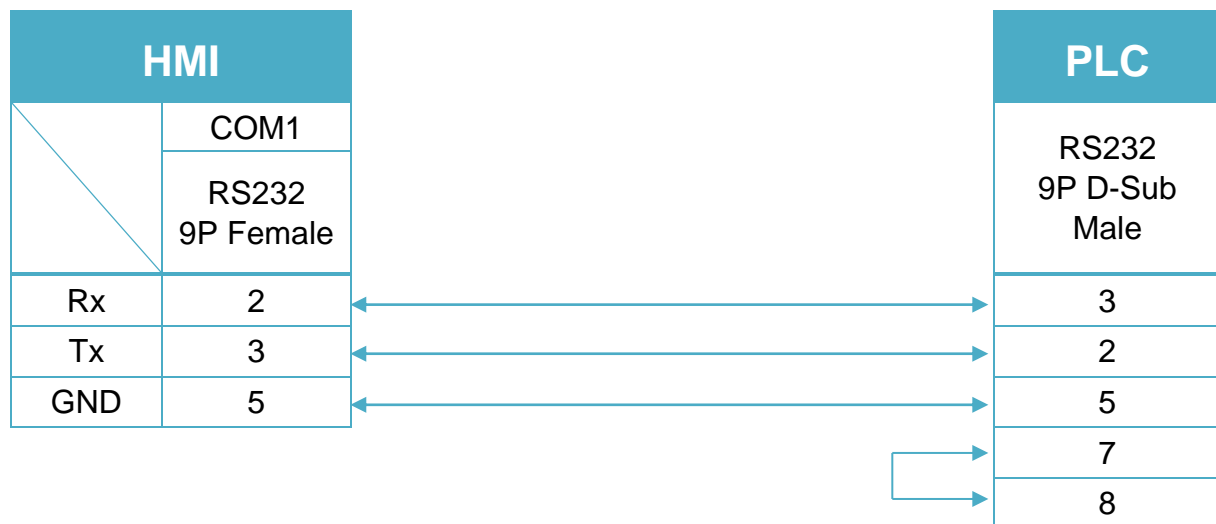
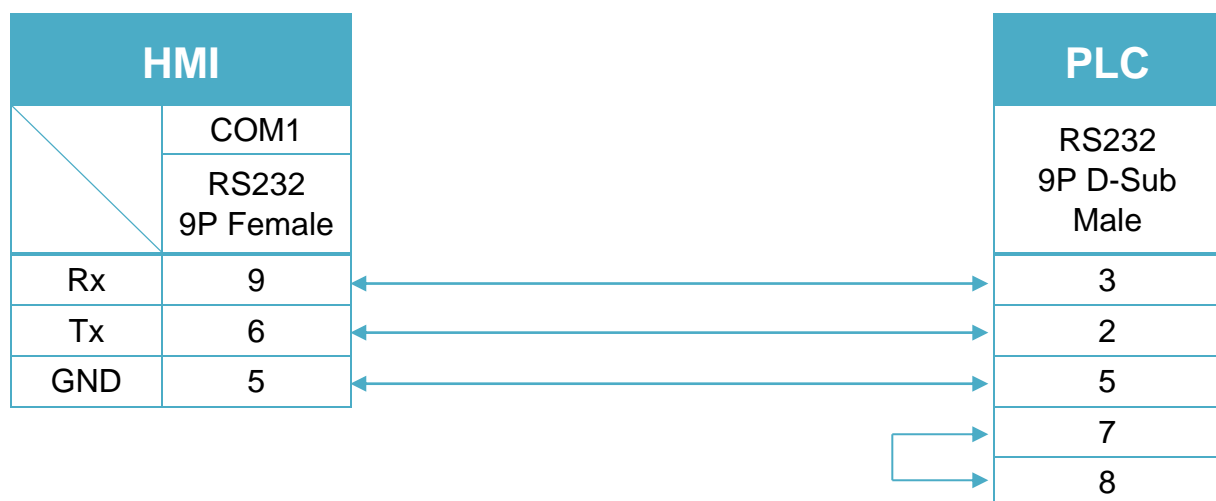


Diagram 6

MT-iE	MT8050iE
MT-iP	MT6051iP / MT6071iP / MT8071iP



RS-485 4W 15 P D-Sub (Diagram7 ~ Diagram10)

Diagram 7

cMT Series	<i>cMT3151</i>
eMT Series	<i>eMT3070 / eMT3105 / eMT3120 / eMT3150</i>
MT-iE	<i>MT8070iE / MT6070iE / MT8100iE / MT8121iE / MT8150iE</i>
MT-XE	<i>MT8121XE / MT8150XE</i>

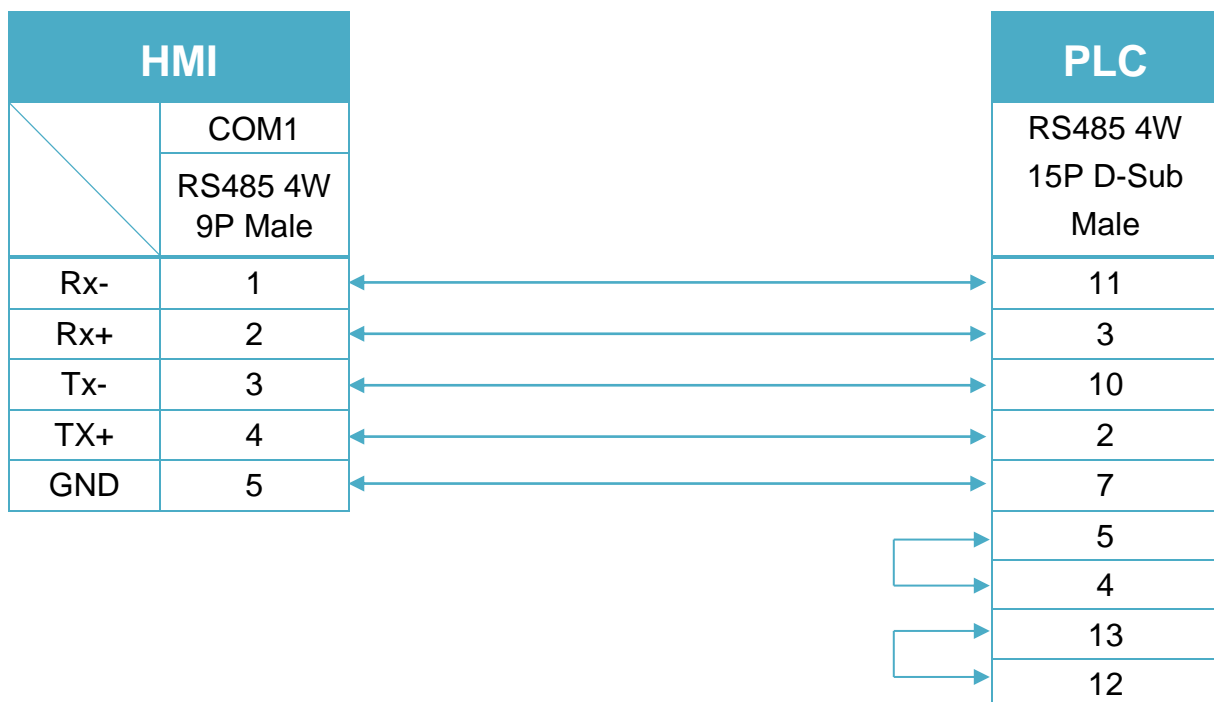


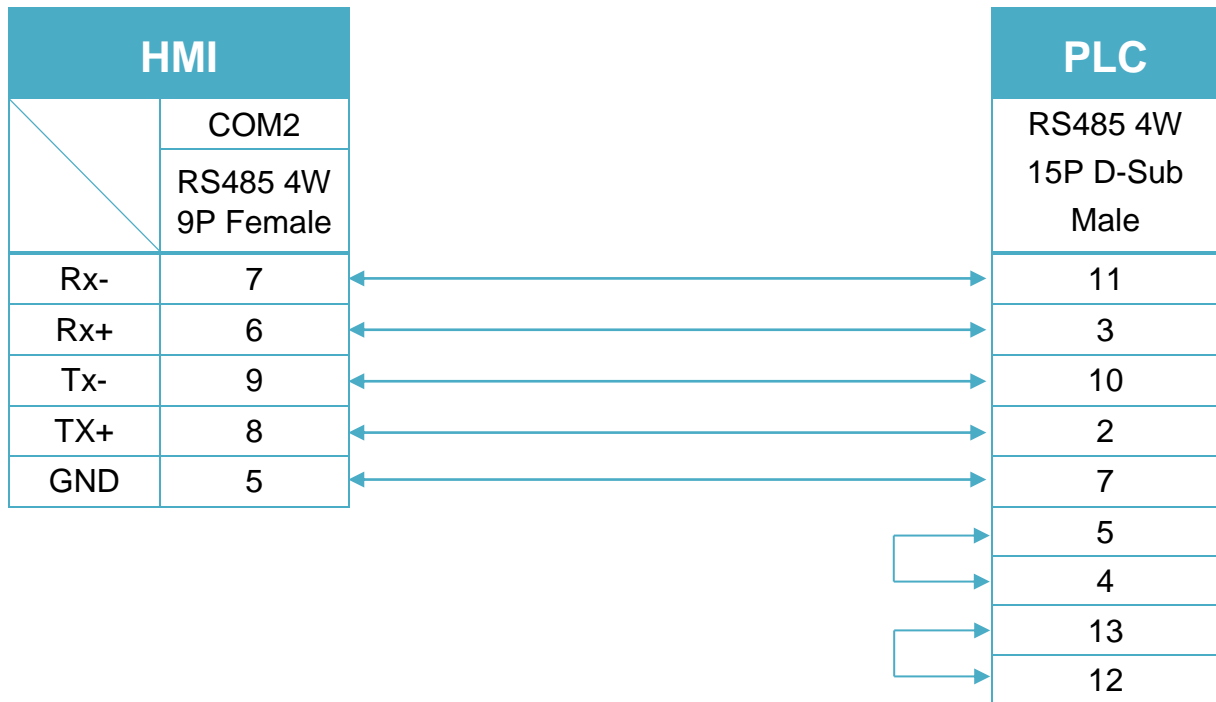
Diagram 8
cMT Series
cMT-SVR
mTV
mTV


Diagram 9

MT-iE	<i>MT8071iE / MT6071iE / MT8072iE / MT6072iE / MT8073iE / MT8101iE / MT8102iE / MT8103iE</i>
MT-XE	<i>MT8090XE / MT8092XE</i>
MT-iP	<i>MT6071iP / MT8071iP / MT6103iP</i>

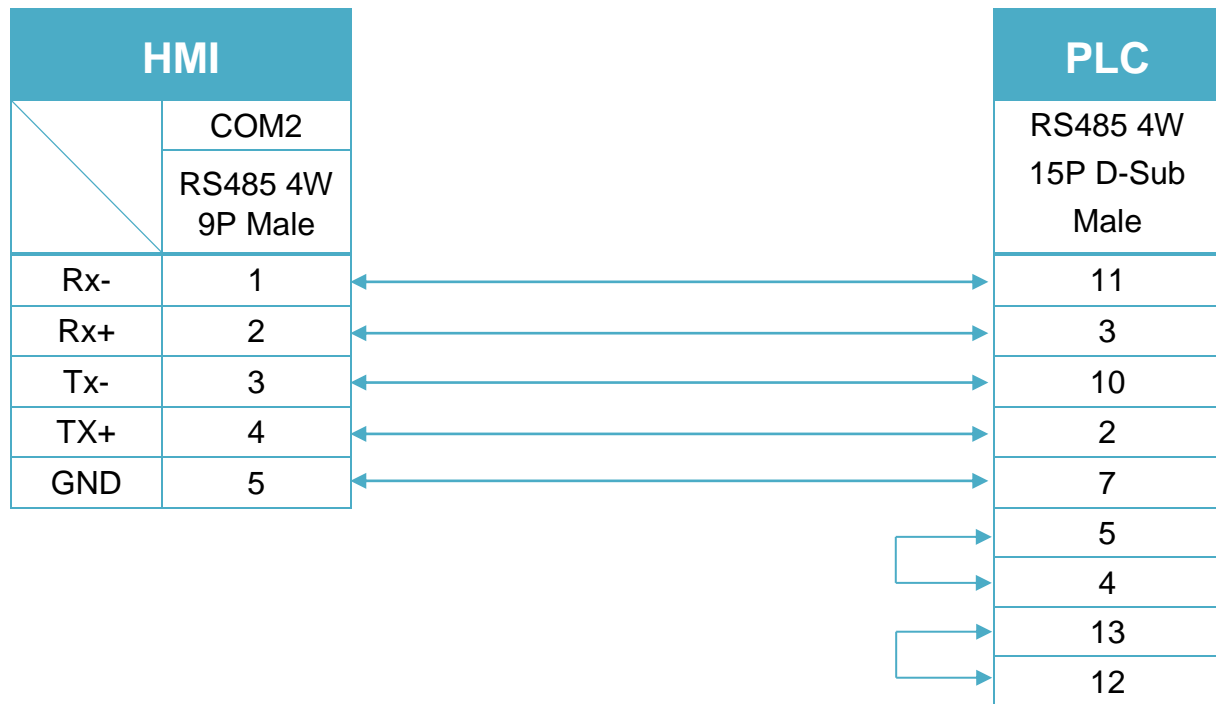
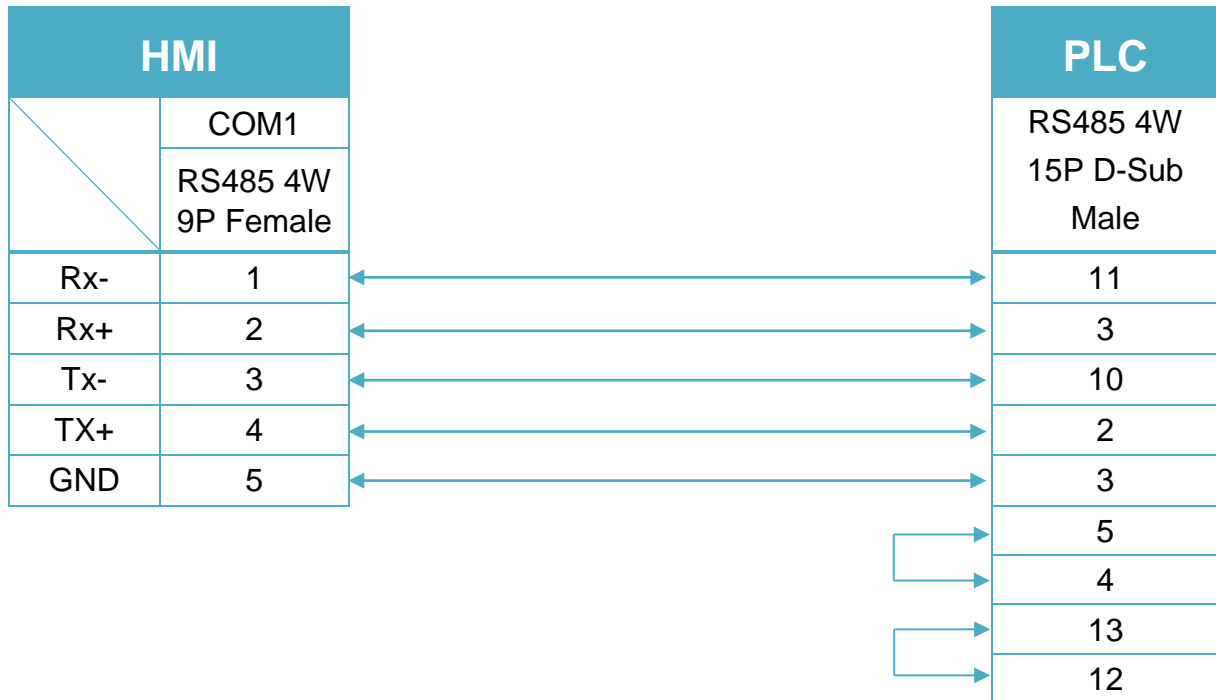


Diagram 10
MT-iE *MT8050iE*
MT-iP *MT6051iP*


TOSHIBA MACHINE Provisor TC200

Supported Series: TOSHIBA MACHINE CO., JAPAN

WebSite: <http://www.toshiba-machine.co.jp>

HMI Setting:

Parameters	Recommended	Options	Notes
PLC type	TOSHIBA MACHINE Provisor TC200		
PLC I/F	RS232	RS232	In accordance with PLC port
Baud rate	9600	9600, 19200	
Data bits	8	7,8	
Parity	None	Even, Odd, None	
Stop bits	1	1, 2	

Device Address:

Bit/Word	Device	Format	Range	Memo
B	R_bit	HHHh	0 ~ ffff	h : Bit no.(0~f)
B	X_bit	HHHh	0 ~ ffff	h : Bit no.(0~f)
B	Y_bit	HHHh	0 ~ ffff	h : Bit no.(0~f)
B	L_bit	HHHh	0 ~ ffff	h : Bit no.(0~f)
B	G_bit	HHHh	0 ~ ffff	h : Bit no.(0~f)
B	H_bit	HHHh	0 ~ ffff	h : Bit no.(0~f)
B	T_bit	HHHh	0 ~ ffff	h : Bit no.(0~f)
B	C_bit	HHHh	0 ~ ffff	h : Bit no.(0~f)
B	S_bit	HHHh	0 ~ ffff	h : Bit no.(0~f)
B	E_bit	HHHh	0 ~ ffff	h : Bit no.(0~f)
W	P	HHH	0 ~ fff	
W	V	HHH	0 ~ fff	
W	X	HHH	0 ~ fff	
W	Y	HHH	0 ~ fff	
W	D	HHH	0 ~ fff	
W	R	HHH	0 ~ fff	
W	L	HHH	0 ~ fff	
W	B	HHH	0 ~ fff	
W	G	HHH	0 ~ fff	
W	H	HHH	0 ~ fff	

Bit/Word	Device	Format	Range	Memo
W	T	HHH	0 ~ fff	
W	C	HHH	0 ~ fff	
W	S	HHH	0 ~ fff	
W	E	HHH	0 ~ fff	

Wiring Diagram:

TC mini series RS232 9P D-Sub (Diagram1 ~ Diagram3)

Diagram 1

cMT Series

cMT3151

eMT Series

eMT3070 / eMT3105 / eMT3120 / eMT3150

MT-iE

MT8073iE / MT8102iE

MT-XE

MT8092XE

MT-iP

MT6103iP

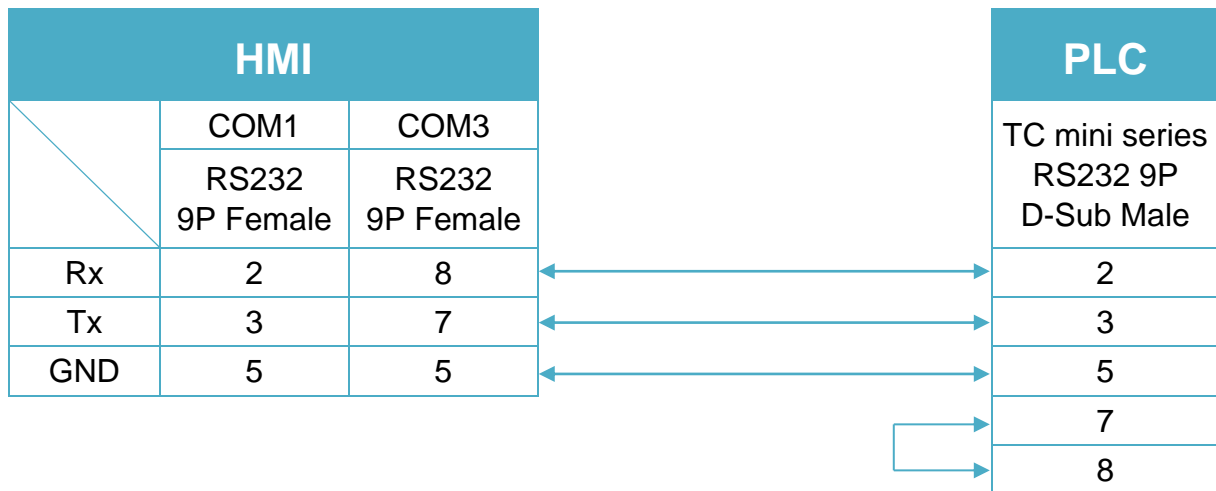


Diagram 2

cMT Series	cMT-SVR
mTV	mTV
MT-iE	MT8070iE / MT6070iE / MT8100iE / MT8121iE / MT8150iE / MT8071iE / MT6071iE / MT8072iE / MT6072iE / MT8073iE / MT8101iE / MT8102iE / MT8103iE
MT-XE	MT8121XE / MT8150XE / MT8090XE

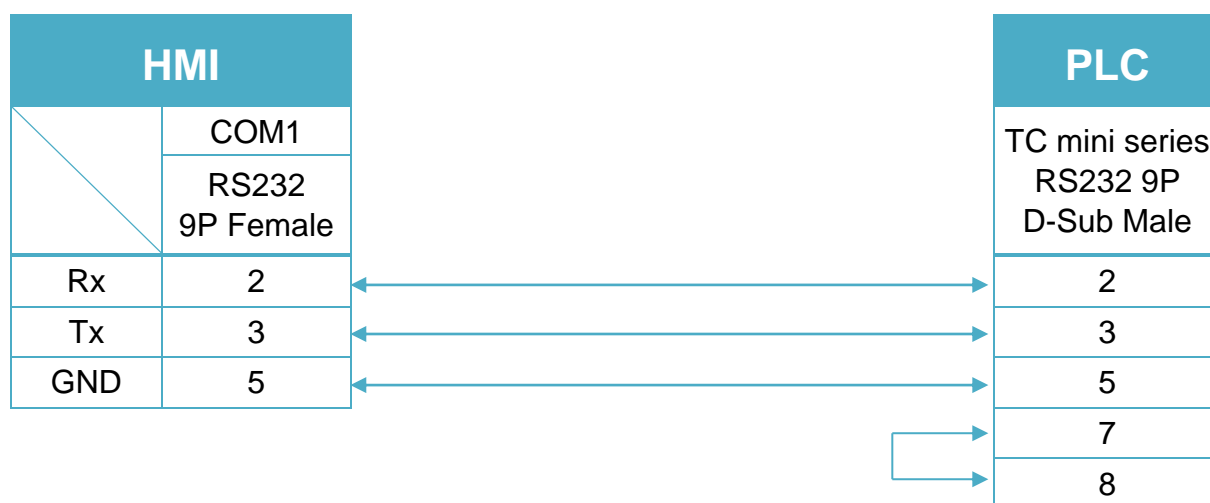
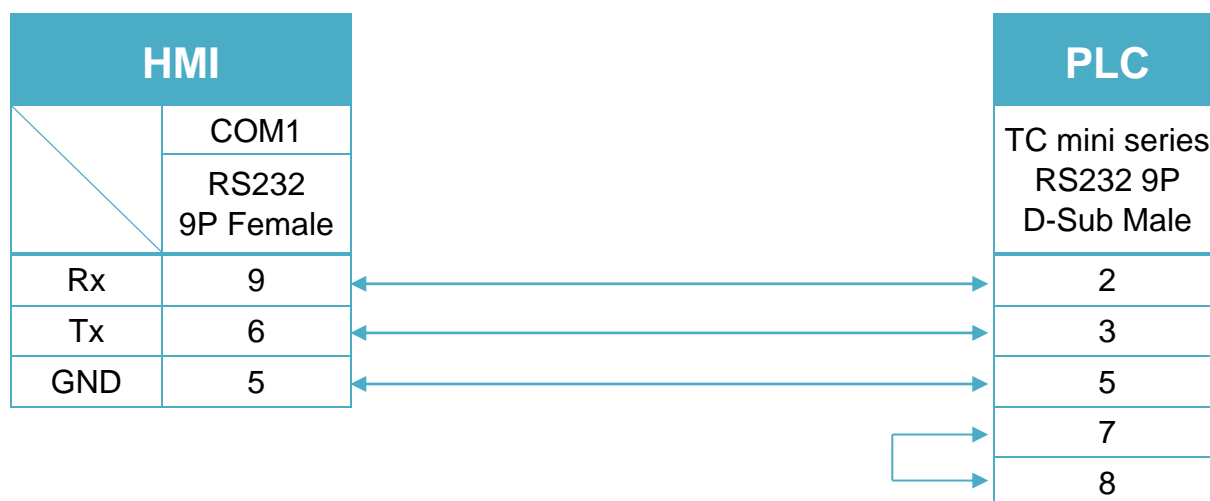


Diagram 3

MT-iE	MT8050iE
MT-iP	MT6051iP / MT6071iP / MT8071iP



Trio MODBUS RTU, TCP/IP

Website : <http://www.triomotion.com>

HMI Setting:

Parameters	Recommended	Options	Notes
PLC type	Trio MODBUS RTU, TCP/IP		
PLC I/F	RS485	RS232/RS485/Ethernet	
Baud rate	9600	9600~115200	
Data bits	8	7, 8	
Parity	Even	Even, Odd, None	
Stop bits	1	1, 2	
Port no.	502		
PLC sta. no.	1	0-255	

Online simulator	YES	Broadcast command	YES
Extend address mode	YES		

PLC Setting:

Communication mode	Modbus RTU protocol
PLC mode	4 (16bit signed integer)

Device Address:

Bit/Word	Device type	Format	Range	Memo
B	VR_Bit	DDDDdd	0 ~ 409615	
B	Table_Bit	DDDDDDdd	0 ~ 3199915	
W	VR	DDDD	0 ~ 4096	
W	Table	DDDDDD	0 ~ 31999	

Wiring Diagram:

RS-232 9P D-Sub (Diagram1 ~ Diagram3)

Diagram 1

cMT Series	<i>cMT3151</i>
eMT Series	<i>eMT3070 / eMT3105 / eMT3120 / eMT3150</i>
MT-iE	<i>MT8073iE / MT8102iE</i>
MT-XE	<i>MT8092XE</i>
MT-iP	<i>MT6103iP</i>

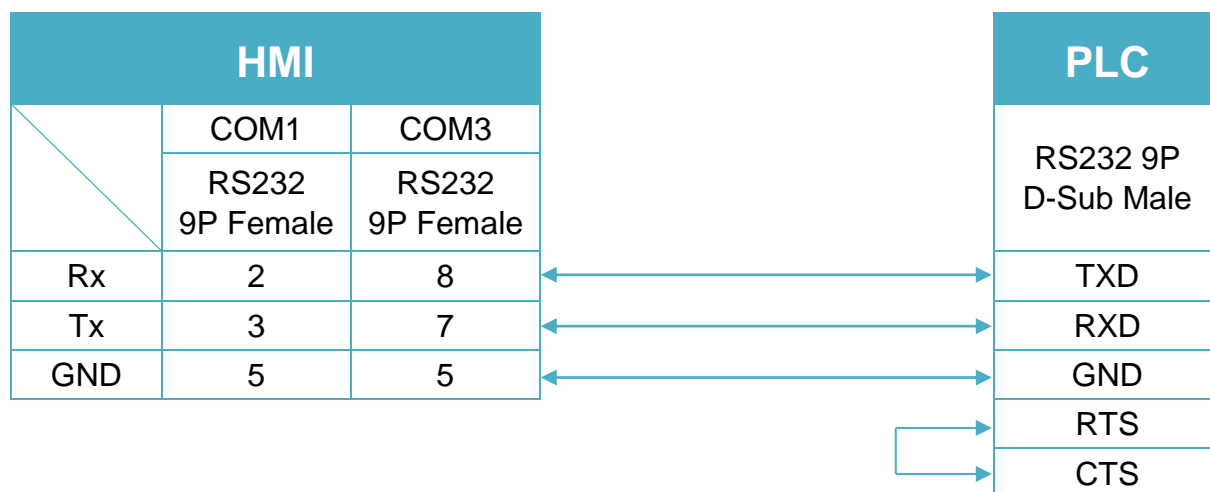


Diagram 2

cMT Series	cMT-SVR
mTV	mTV
MT-iE	MT8070iE / MT6070iE / MT8100iE / MT8121iE / MT8150iE / MT8071iE / MT6071iE / MT8072iE / MT6072iE / MT8073iE / MT8101iE / MT8102iE / MT8103iE
MT-XE	MT8121XE / MT8150XE / MT8090XE

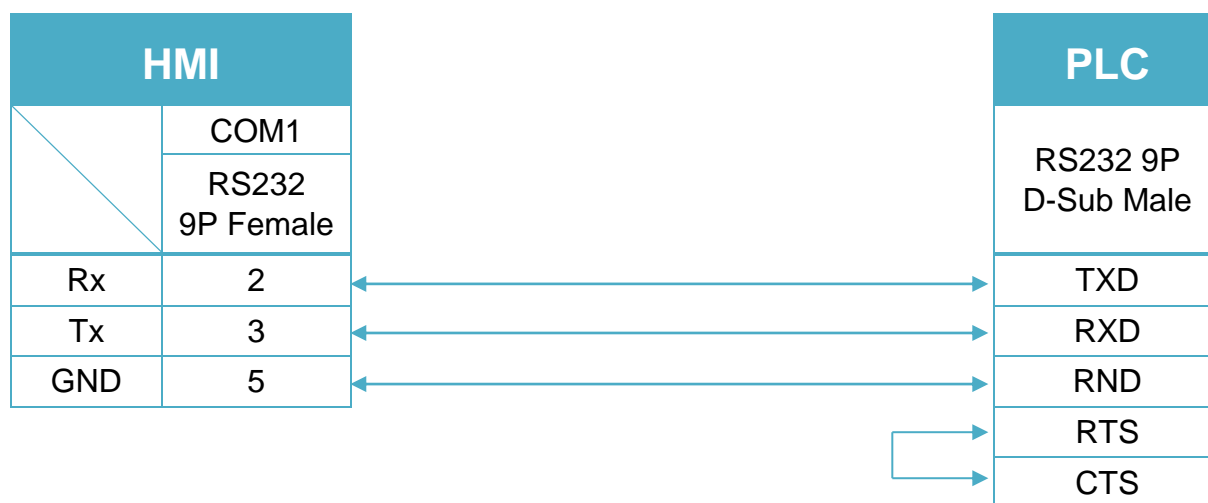
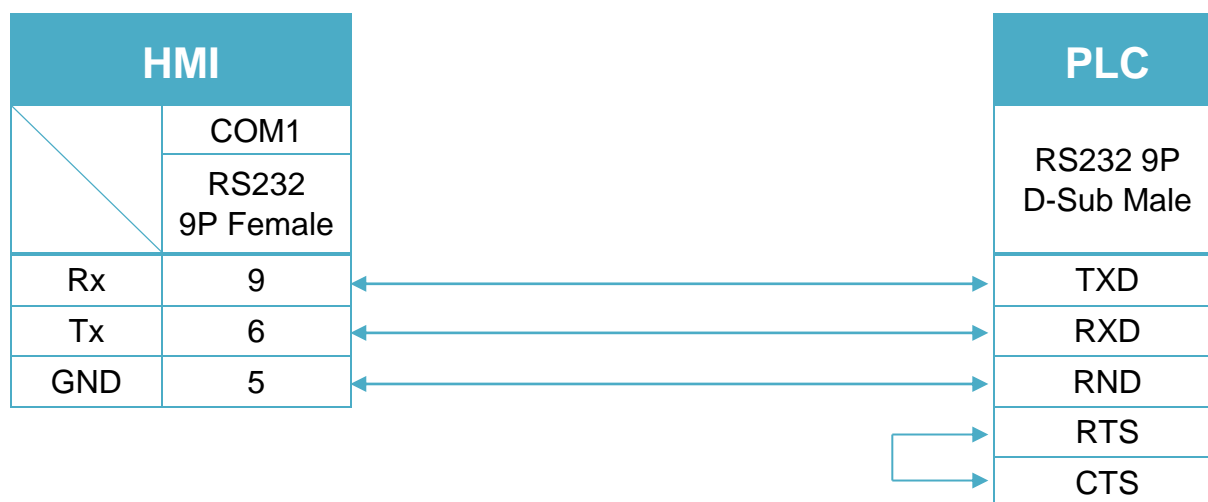


Diagram 3

MT-iE	MT8050iE
MT-iP	MT6051iP / MT6071iP / MT8071iP



RS-485 4W 9P D-Sub (Diagram4 ~ Diagram7)

Diagram 4

cMT Series	<i>cMT3151</i>
eMT Series	<i>eMT3070 / eMT3105 / eMT3120 / eMT3150</i>
MT-iE	<i>MT8070iE / MT6070iE / MT8100iE / MT8121iE / MT8150iE</i>
MT-XE	<i>MT8121XE / MT8150XE</i>

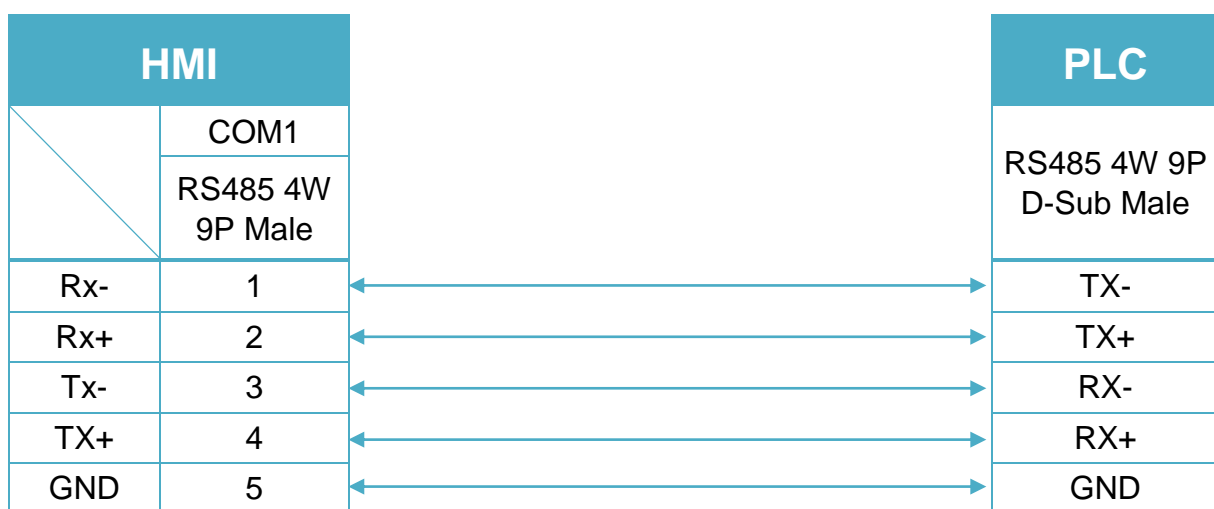


Diagram 5

cMT Series	<i>cMT-SVR</i>
mTV	<i>mTV</i>

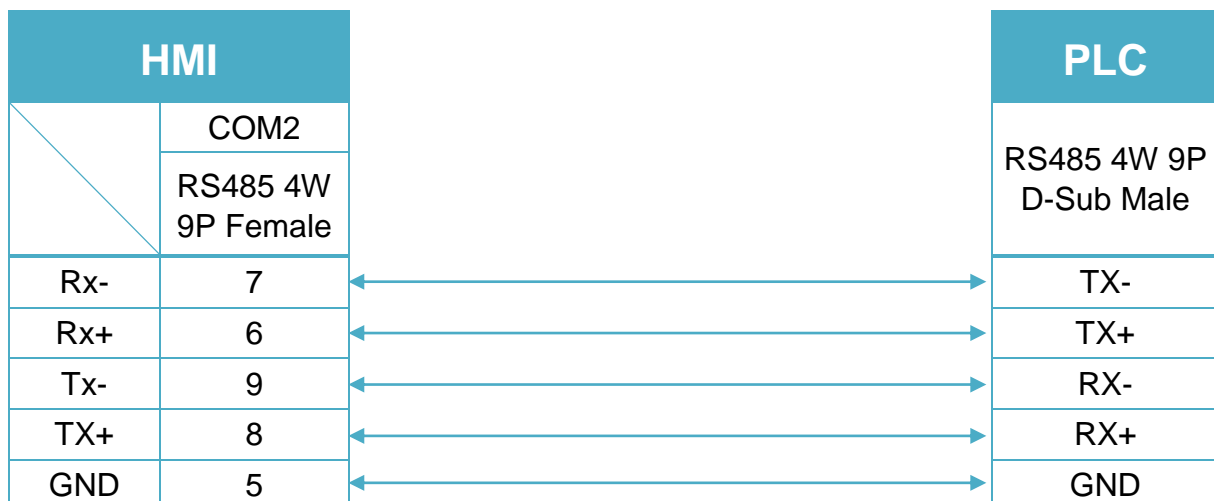


Diagram 6

MT-iE	<i>MT8071iE / MT6071iE / MT8072iE / MT6072iE / MT8073iE / MT8101iE / MT8102iE / MT8103iE</i>
MT-XE	<i>MT8090XE / MT8092XE</i>
MT-iP	<i>MT6071iP / MT8071iP / MT6103iP</i>

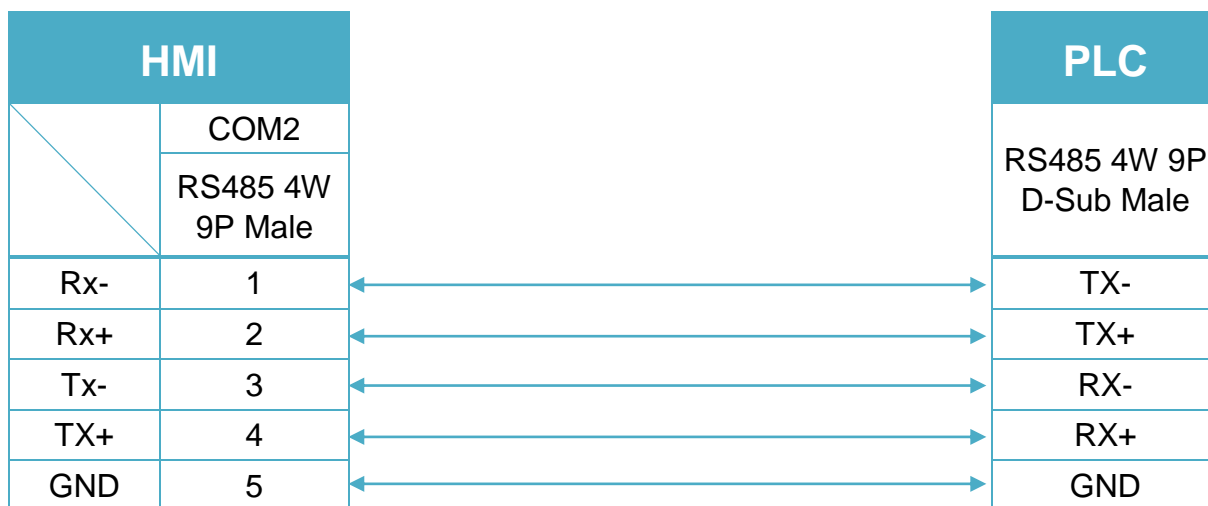
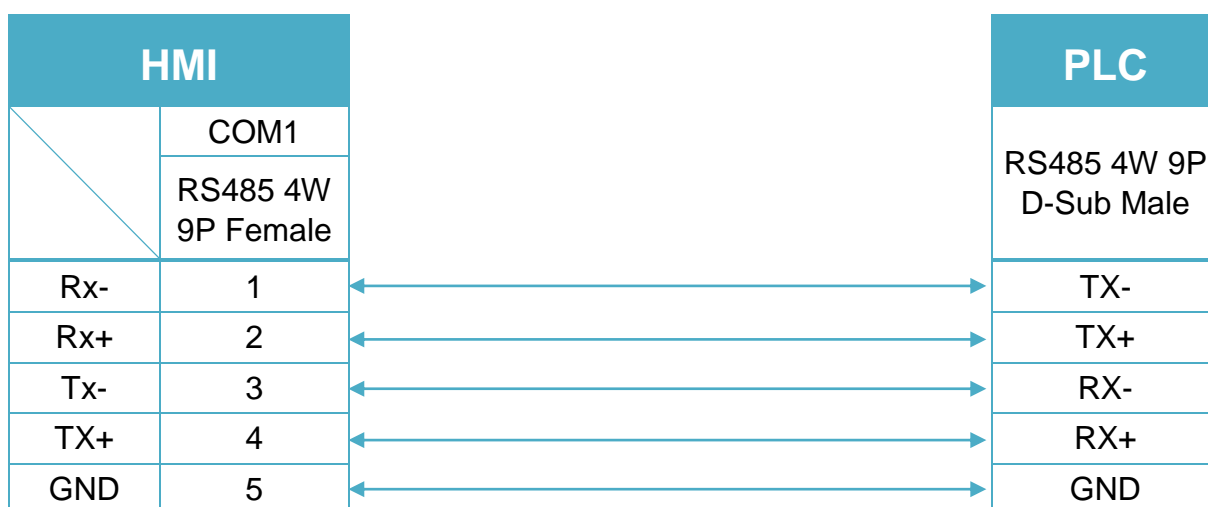


Diagram 7

MT-iE	<i>MT8050iE</i>
MT-iP	<i>MT6051iP</i>



RS-485 2W 9P D-Sub (Diagram8 ~ Diagram13)

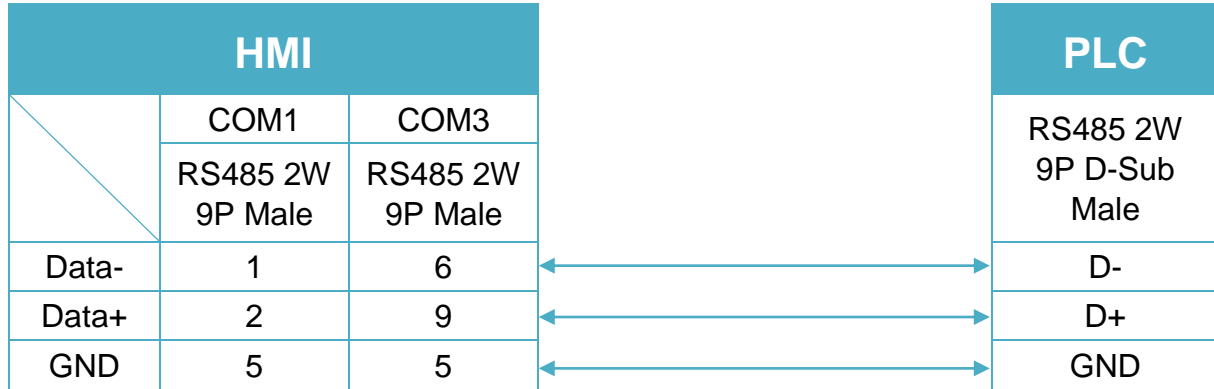
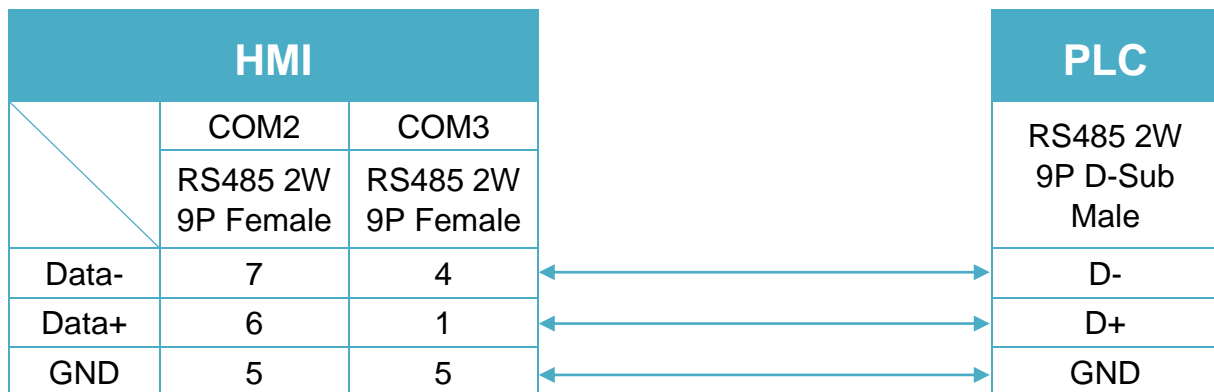
Diagram 8
cMT Series *cMT3151*
eMT Series *eMT3070/ eMT3105 / eMT3120 / eMT3150*

Diagram 9
cMT Series *cMT-SVR*
mTV *mTV*


Diagram 10

MT-iE *MT8070iE / MT6070iE / MT8100iE / MT8121iE / MT8150iE*

MT-XE *MT8121XE / MT8150XE*

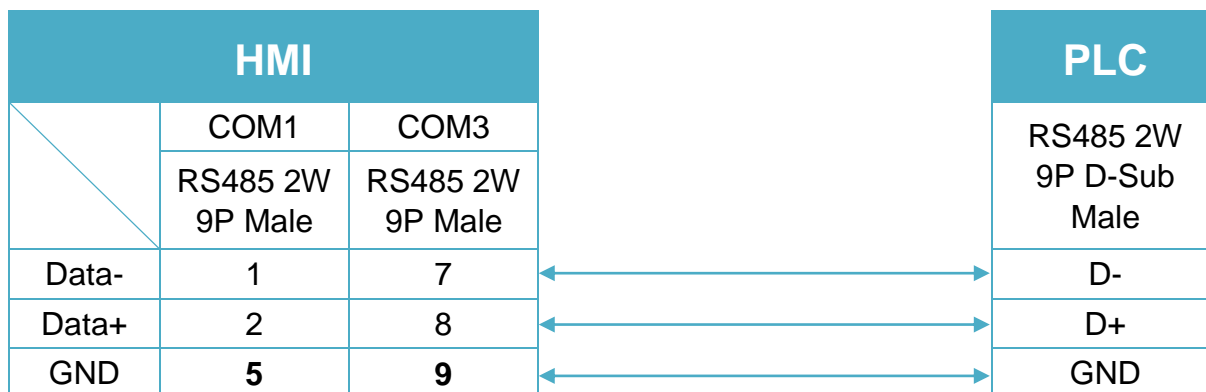


Diagram 11

MT-iE *MT8071iE / MT6071iE / MT8072iE / MT6072iE / MT8073iE /
MT8101iE / MT8102iE / MT8103iE*

MT-XE *MT8090XE / MT8092XE*

MT-iP *MT6103iP*

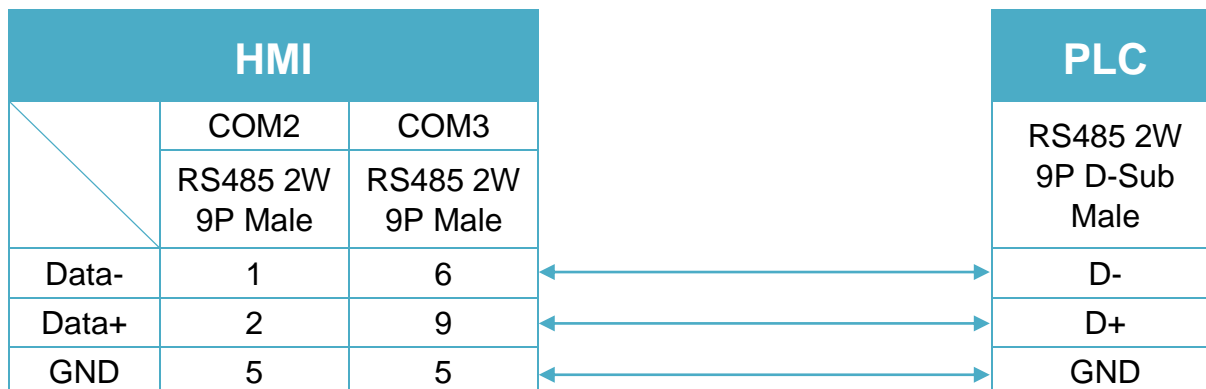


Diagram 12

MT-iE *MT8050iE*

MT-iP *MT6051iP*

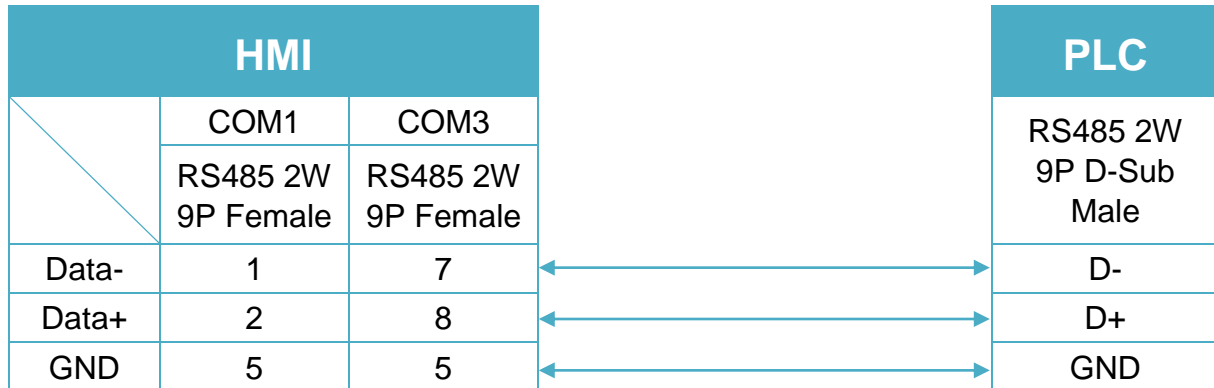


Diagram 13

MT-iP *MT6071iP / MT8071iP*

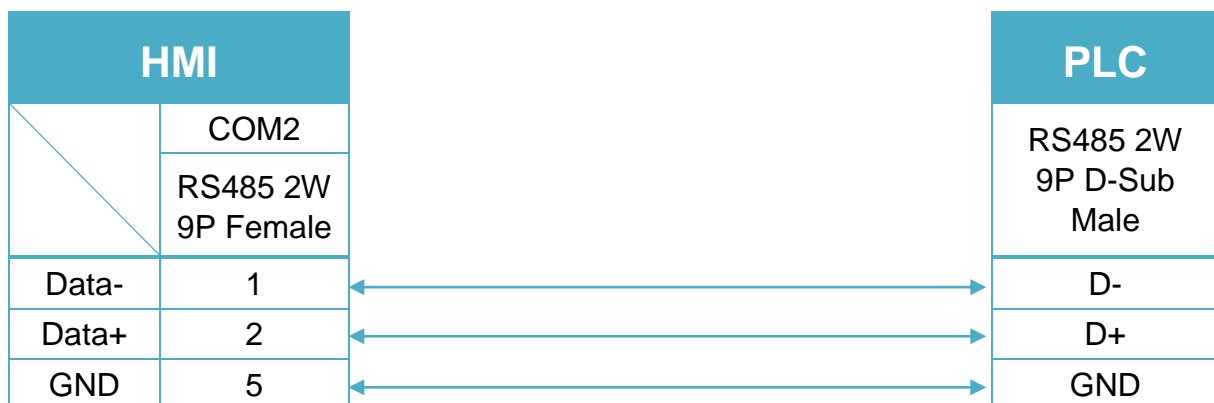


Diagram 14

Etehernet cable:



Trio MODBUS RTU, TCP/IP (Mode 7)

Website : <http://www.triomotion.com>

HMI Setting:

Parameters	Recommended	Options	Notes
PLC type	Trio MODBUS RTU, TCP/IP (Mode 7)		
PLC I/F	RS485	RS232/RS485/Ethernet	
Baud rate	9600	9600~115200	
Data bits	8	7, 8	
Parity	Even	Even, Odd, None	
Stop bits	1	1, 2	
Port no.	502		
PLC sta. no.	1	0-255	

Online simulator	YES	Broadcast command	YES
Extend address mode	YES		

PLC Setting:

Communication mode	Modbus RTU protocol
PLC mode	7 (IEEE floating point)

Device Address:

Bit/Word	Device type	Format	Range	Memo
B	VR_Bit	DDDDdd	0 ~ 409631	
B	VR_INT_Bit	DDDDdd	0 ~ 409631	
B	Table_Bit	DDDDDdd	0 ~ 3199931	
W	VR	DDDD	0 ~ 4096	
W	VR_INT	DDDD	0 ~ 4096	
W	Table	DDDDD	0 ~ 31999	
W	Table_INT	DDDDD	0 ~ 31999	

Wiring Diagram:

RS-232 9P D-Sub (Diagram1 ~ Diagram3)

Diagram 1

cMT Series	<i>cMT3151</i>
eMT Series	<i>eMT3070 / eMT3105 / eMT3120 / eMT3150</i>
MT-iE	<i>MT8073iE / MT8102iE</i>
MT-XE	<i>MT8092XE</i>
MT-iP	<i>MT6103iP</i>

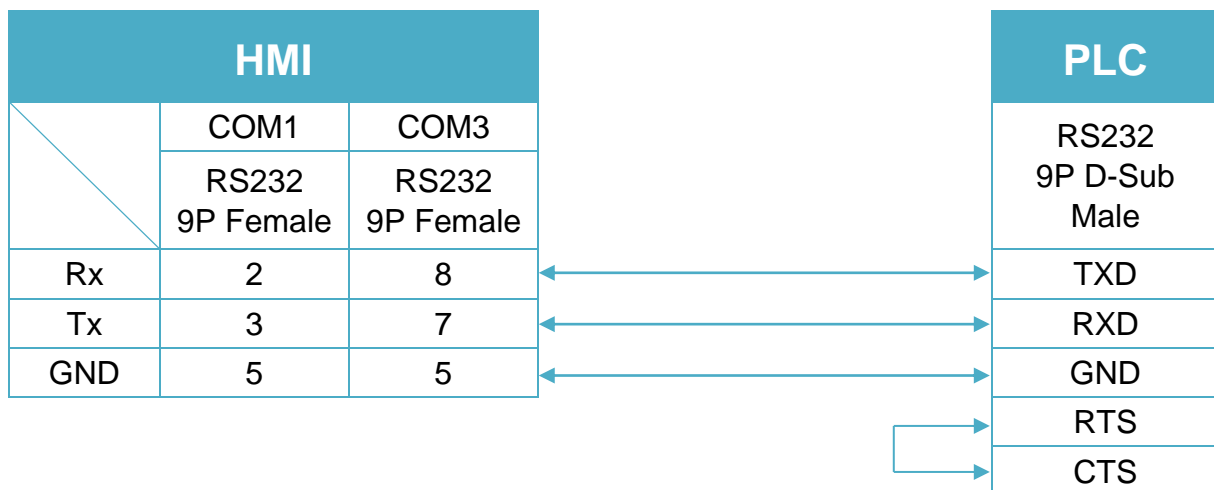


Diagram 2

cMT Series	cMT-SVR
mTV	mTV
MT-iE	MT8070iE / MT6070iE / MT8100iE / MT8121iE / MT8150iE / MT8071iE / MT6071iE / MT8072iE / MT6072iE / MT8073iE / MT8101iE / MT8102iE / MT8103iE
MT-XE	MT8121XE / MT8150XE / MT8090XE

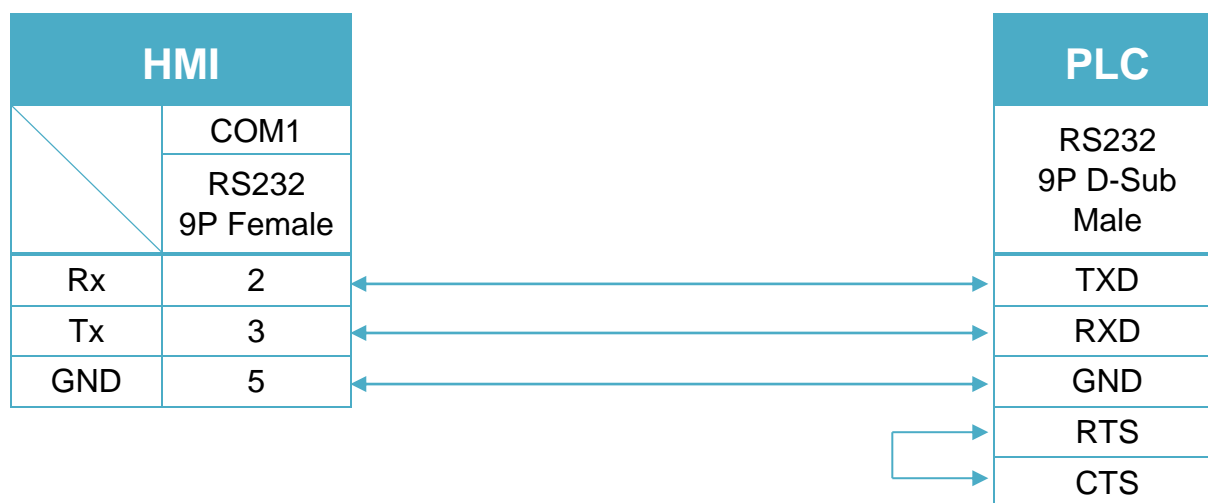
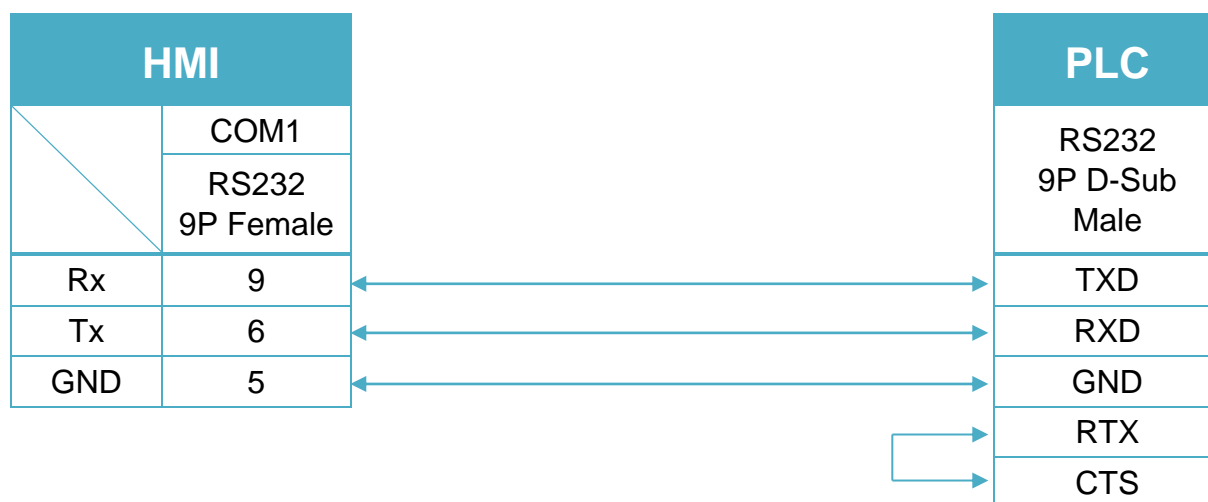


Diagram 3

MT-iE	MT8050iE
MT-iP	MT6051iP / MT6071iP / MT8071iP



RS-485 4W 9P D-Sub (Diagram4~ Diagram7)

Diagram 4

cMT Series	<i>cMT3151</i>
eMT Series	<i>eMT3070 / eMT3105 / eMT3120 / eMT3150</i>
MT-iE	<i>MT8070iE / MT6070iE / MT8100iE / MT8121iE / MT8150iE</i>
MT-XE	<i>MT8121XE / MT8150XE</i>

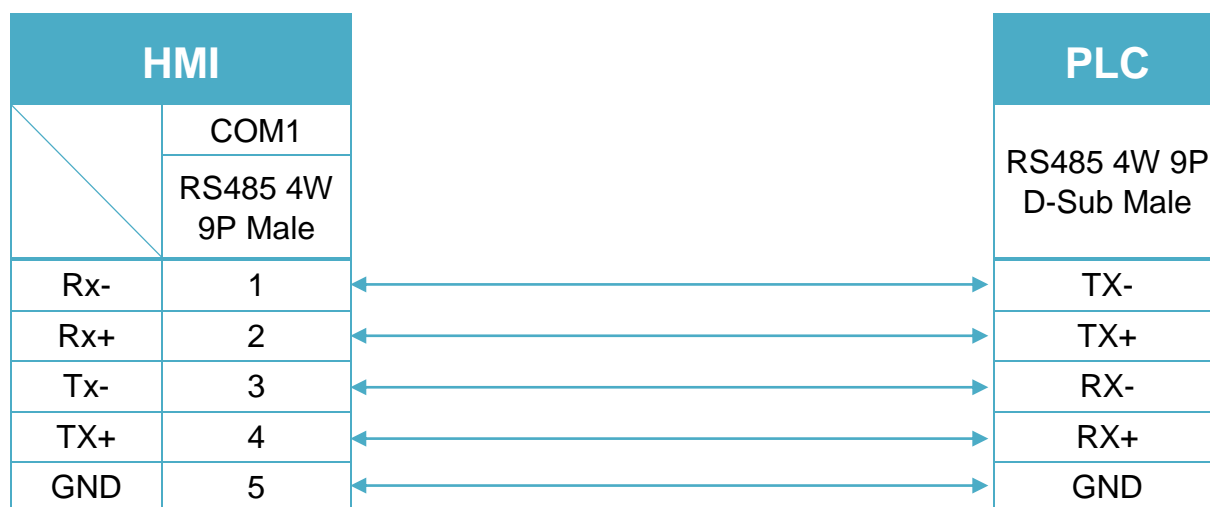


Diagram 5

cMT Series	<i>cMT-SVR</i>
mTV	<i>mTV</i>

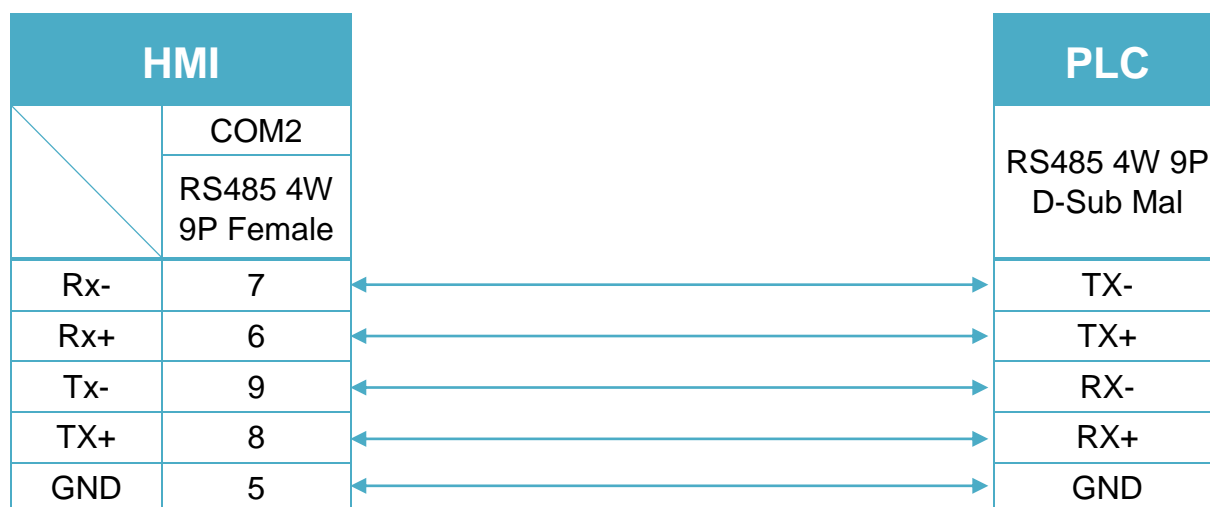


Diagram 6

MT-iE	<i>MT8071iE / MT6071iE / MT8072iE / MT6072iE / MT8073iE / MT8101iE / MT8102iE / MT8103iE</i>
MT-XE	<i>MT8090XE / MT8092XE</i>
MT-iP	<i>MT6071iP / MT8071iP / MT6103iP</i>

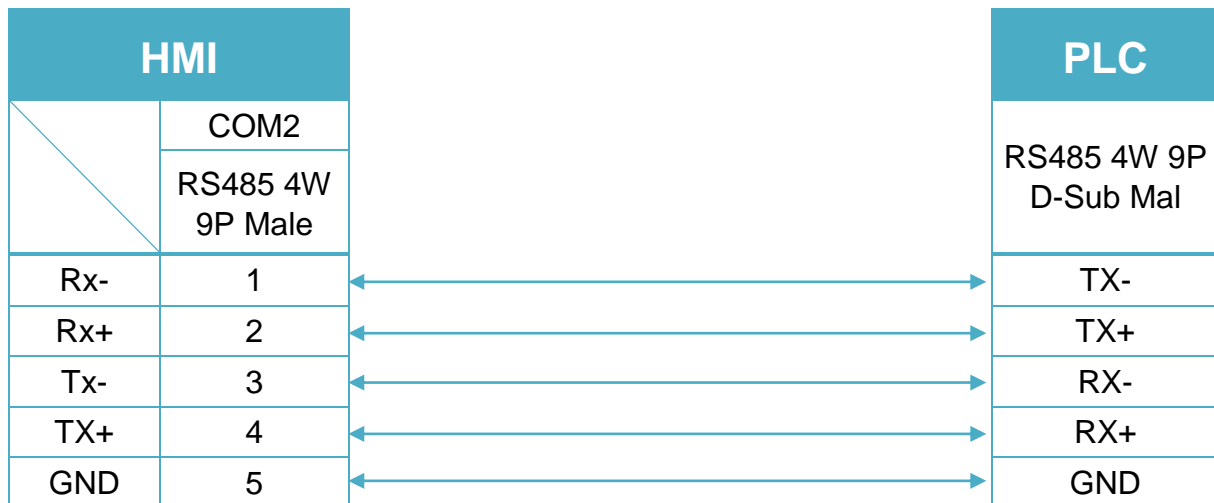
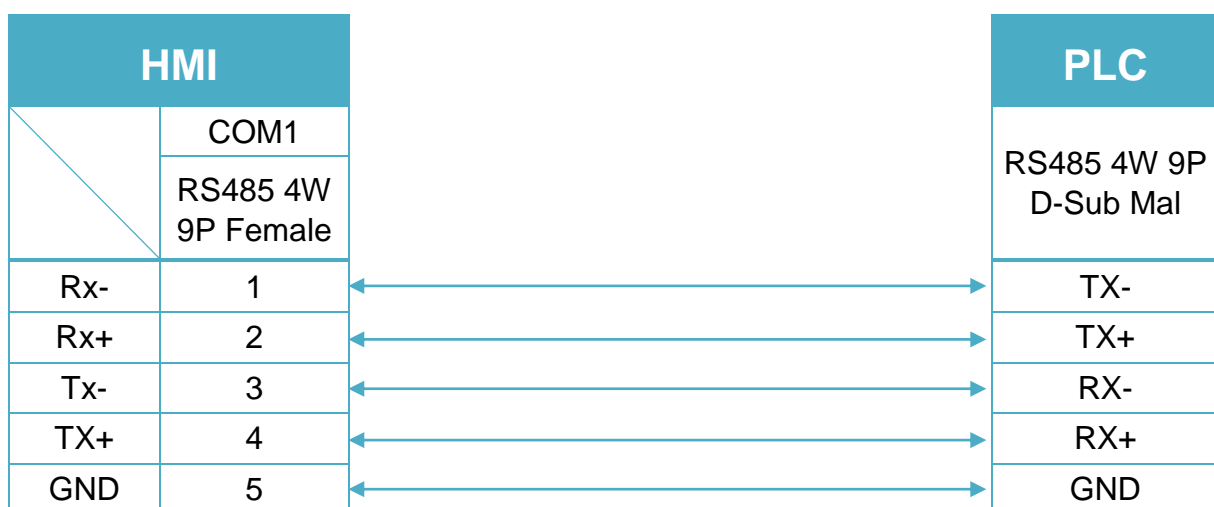


Diagram 7

MT-iE	<i>MT8050iE</i>
MT-iP	<i>MT6051iP</i>



RS-485 2W 9P D-Sub (Diagram8~ Diagram13)

Diagram 8

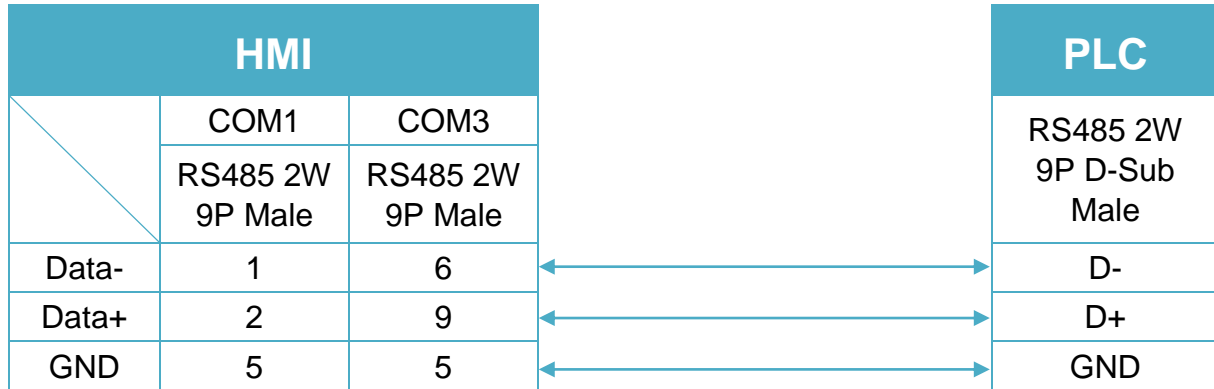
cMT Series
cMT3151
eMT Series
eMT3070 / eMT3105 / eMT3120 / eMT3150


Diagram 9

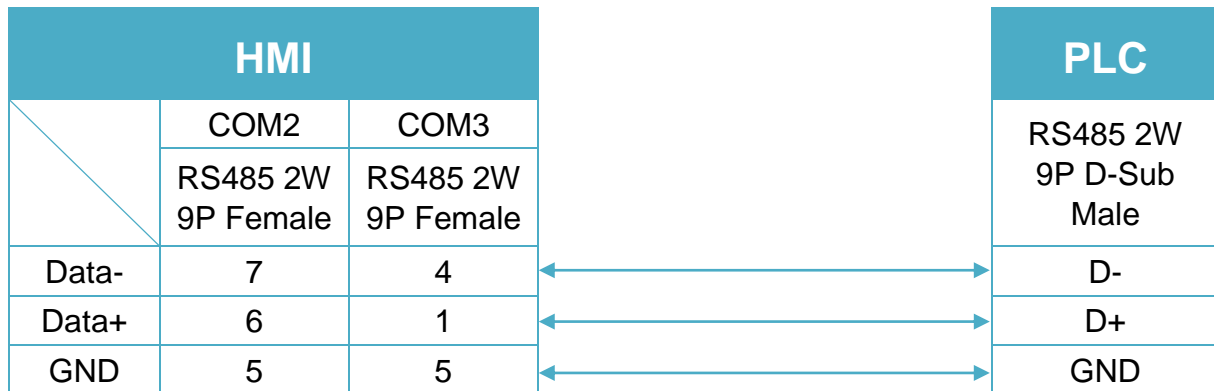
cMT Series
cMT-SVR
mTV
mTV


Diagram 10

MT-iE *MT8070iE / MT6070iE / MT8100iE / MT8121iE / MT8150iE*

MT-XE *MT8121XE / MT8150XE*

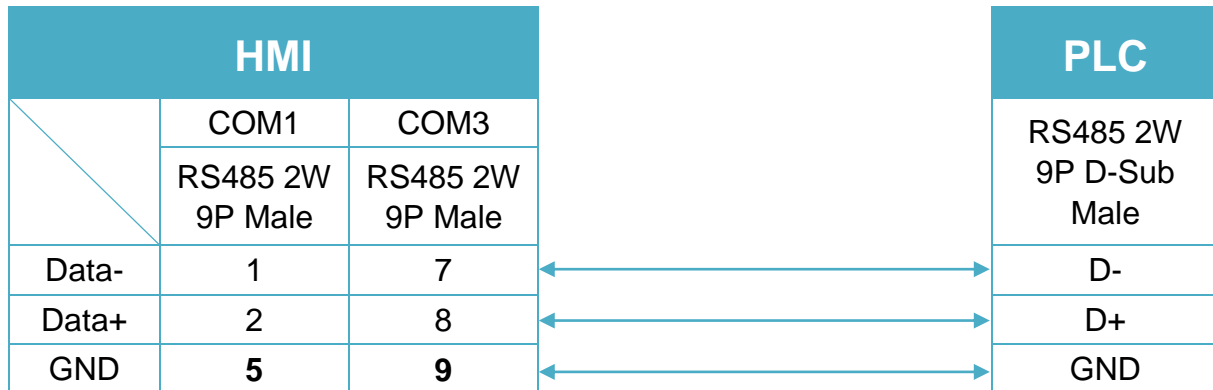


Diagram 11

MT-iE *MT8071iE / MT6071iE / MT8072iE / MT6072iE / MT8073iE /
MT8101iE / MT8102iE / MT8103iE*

MT-XE *MT8090XE / MT8092XE*

MT-iP *MT6103iP*

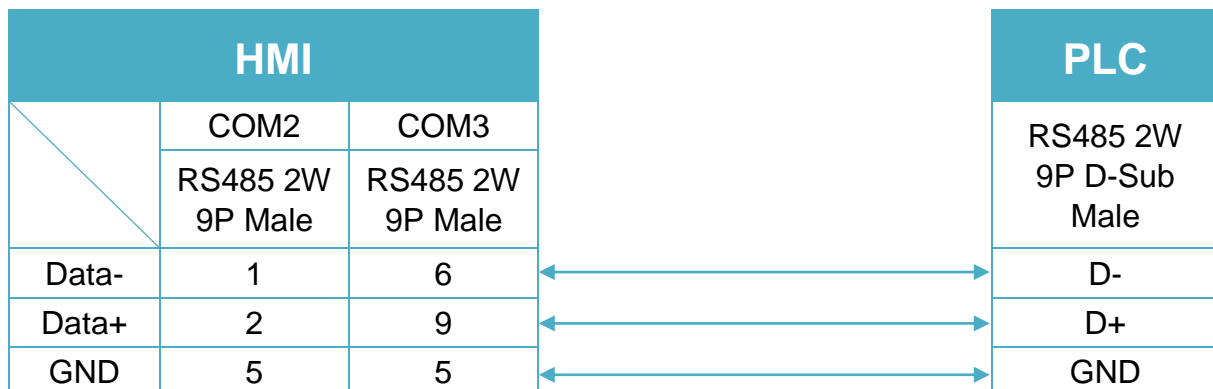


Diagram 12

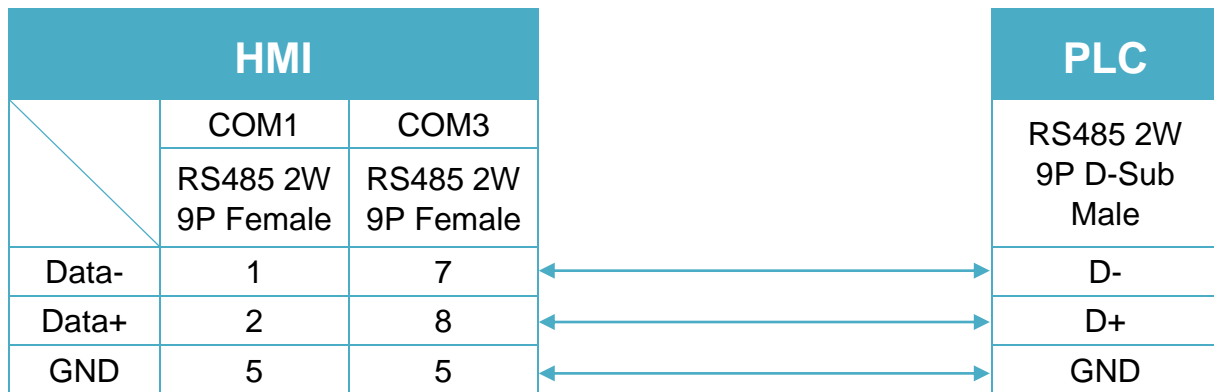
MT-iE *MT8050iE*
MT-iP *MT6051iP*


Diagram 13

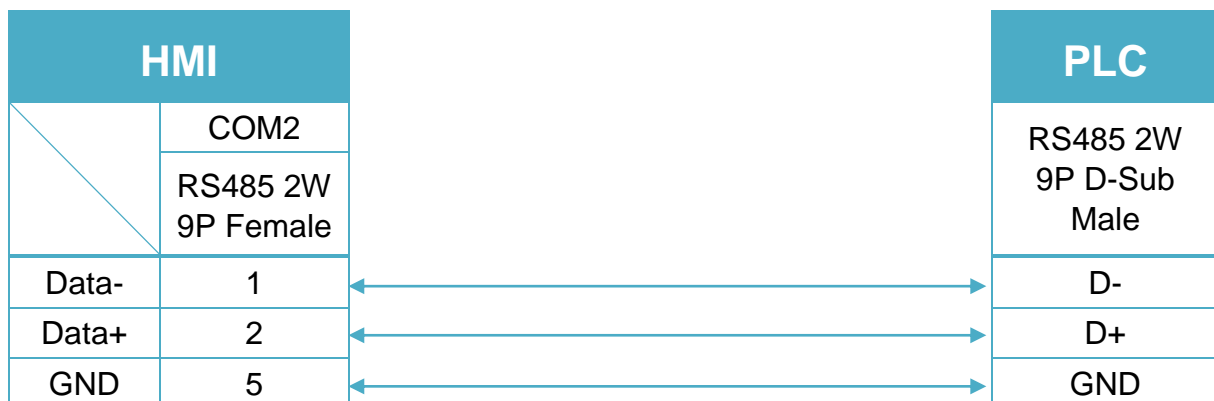
MT-iP *MT6071iP / MT8071iP*


Diagram 14

Ethernet cable:


VIGOR

Supported Series: VIGOR M Series, VB Series, VH Series.

Website: <http://www.vigorplc.com.tw/>

HMI Setting:

Parameters	Recommended	Options	Notes
PLC type	VIGOR		
PLC I/F	RS485 2W	RS232, RS485 4W	
Baud rate	19200		
Data bits	8		Select "7" for V1.10 and previous versions.
Parity	None		Select "Even" for V1.10 and previous versions.
Stop bits	1		
PLC sta. no.	0		

*Support communications between HMI and PLC in pass-through mode

*Set LW-9903 to 2 to enhance the speed of download/upload PLC program in pass-through mode

Device Address:

Bit/Word	Device type	Format	Range	Memo
B	X	OOO	0 ~ 377	
B	Y	OOO	0 ~ 377	
B	M	DDDD	0 ~ 7999	
B	T	DDD	0 ~ 255	
B	C	DDD	0 ~ 255	
B	SM	DDDD	9000 ~ 9255	
B	S	DDD	0 ~ 999	
W	TV	DDD	0 ~ 255	
W	CV	DDD	0 ~ 199	
W	D	DDDD	0 ~ 9255	
W	CV2	DDD	200 ~ 255	
W	SD	DDDD	9000 ~ 9255	

Wiring Diagram:

RS-485 4W 6P Terminal (Diagram1~ Diagram4)

Diagram 1

cMT Series	<i>cMT3151</i>
eMT Series	<i>eMT3070 / eMT3105 / eMT3120 / eMT3150</i>
MT-iE	<i>MT8070iE / MT6070iE / MT8100iE / MT8121iE / MT8150iE</i>
MT-XE	<i>MT8121XE / MT8150XE</i>

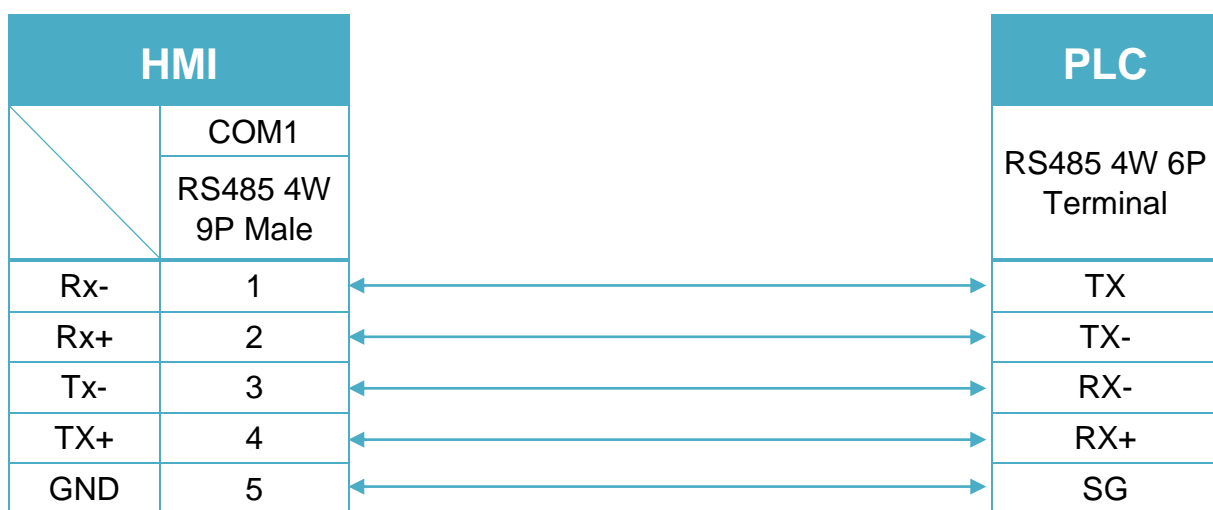


Diagram 2

cMT Series	<i>cMT-SVR</i>
mTV	<i>mTV</i>

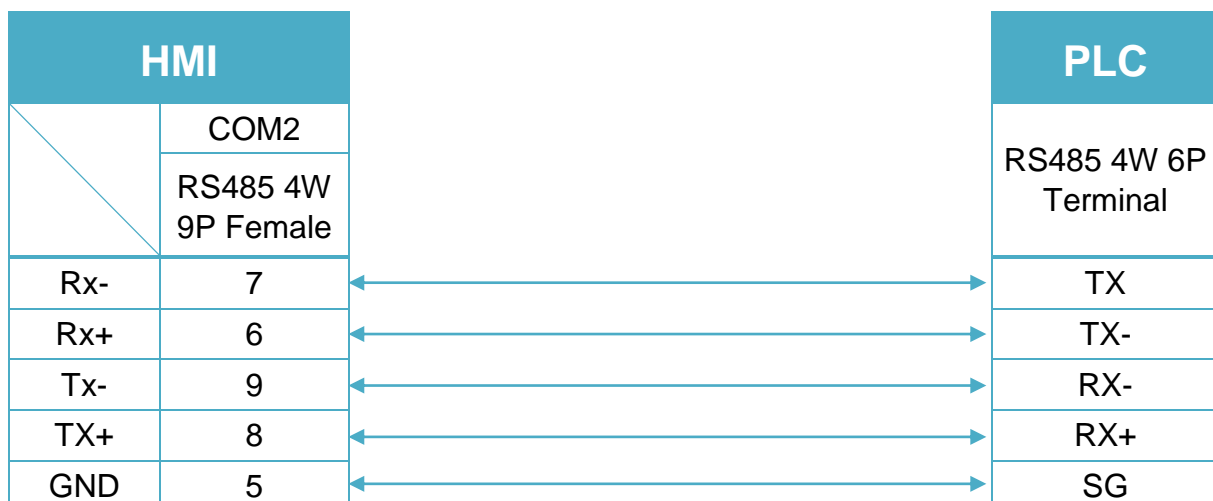


Diagram 3

MT-iE	<i>MT8071iE / MT6071iE / MT8072iE / MT6072iE / MT8073iE / MT8101iE / MT8102iE / MT8103iE</i>
MT-XE	<i>MT8090XE / MT8092XE</i>
MT-iP	<i>MT6071iP / MT8071iP / MT6103iP</i>

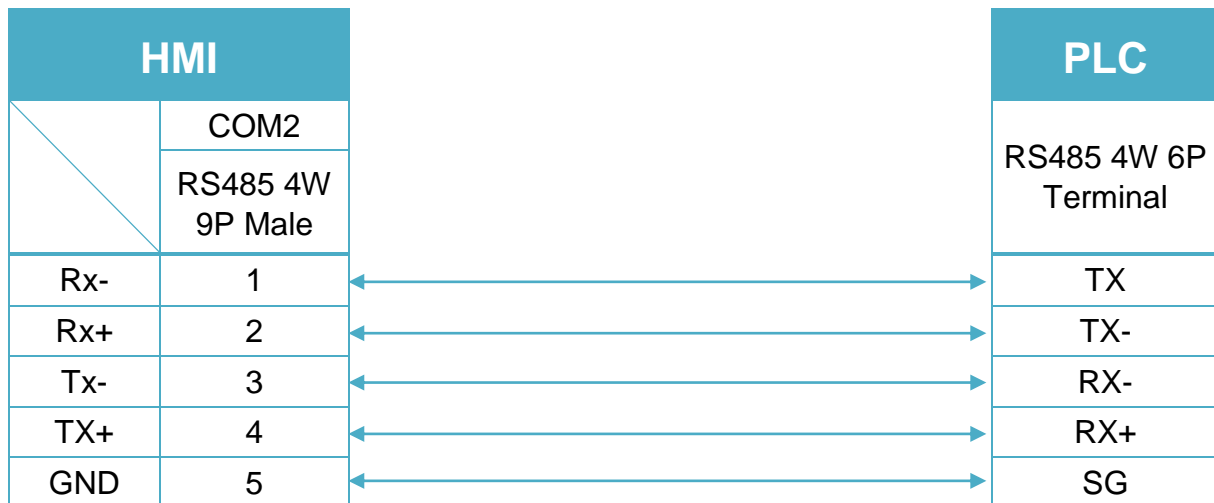
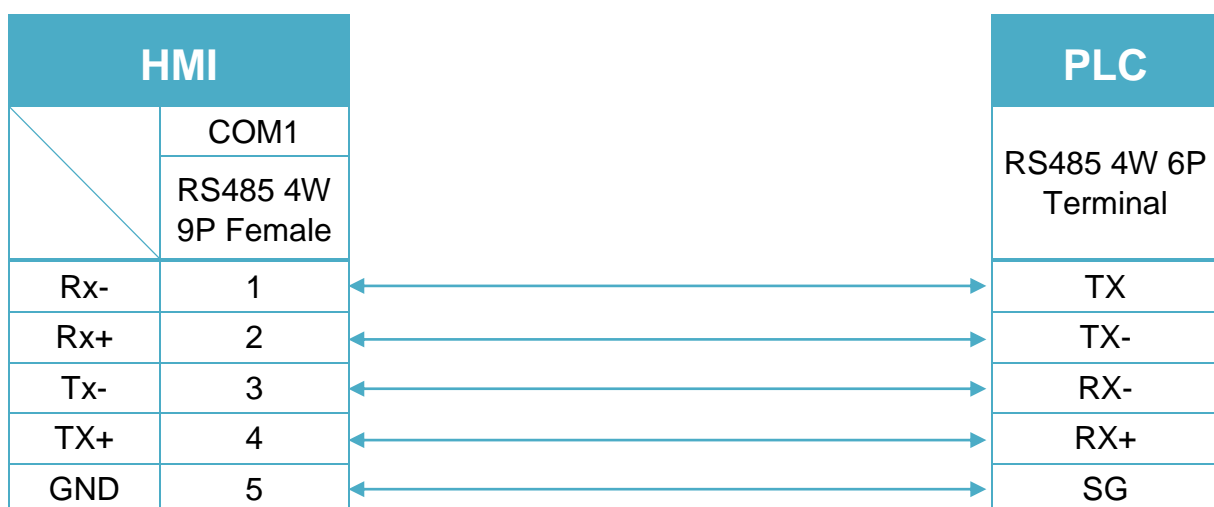


Diagram 4

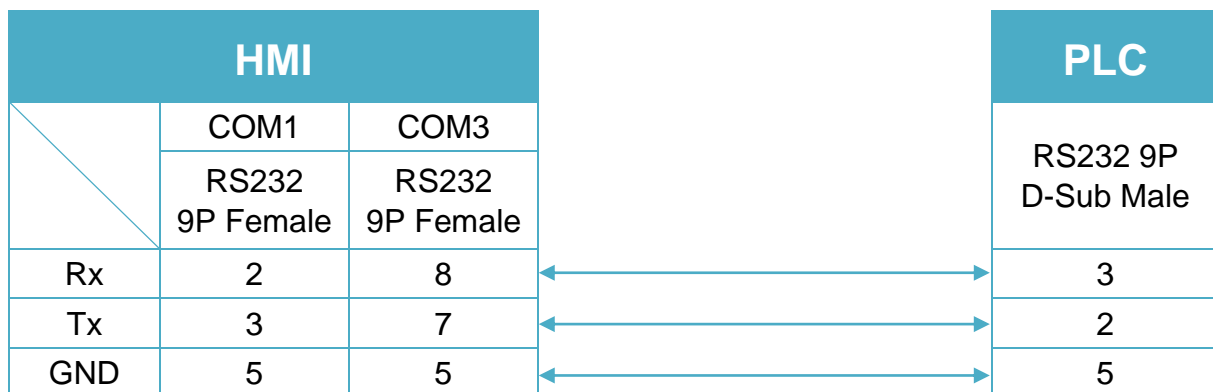
MT-iE	<i>MT8050iE</i>
MT-iP	<i>MT6051iP</i>



RS-232 9P D-Sub (Diagram5~ Diagram7)

Diagram 5

cMT Series	<i>cMT3151</i>
eMT Series	<i>eMT3070 / eMT3105 / eMT3120 / eMT3150</i>
MT-iE	<i>MT8073iE / MT8102iE</i>
MT-XE	<i>MT8092XE</i>
MT-iP	<i>MT6103iP</i>


Diagram 6

cMT Series	<i>cMT-SVR</i>
mTV	<i>mTV</i>
MT-iE	<i>MT8070iE / MT6070iE / MT8100iE / MT8121iE / MT8150iE / MT8071iE / MT6071iE / MT8072iE / MT6072iE / MT8073iE / MT8101iE / MT8102iE / MT8103iE</i>
MT-XE	<i>MT8121XE / MT8150XE / MT8090XE</i>

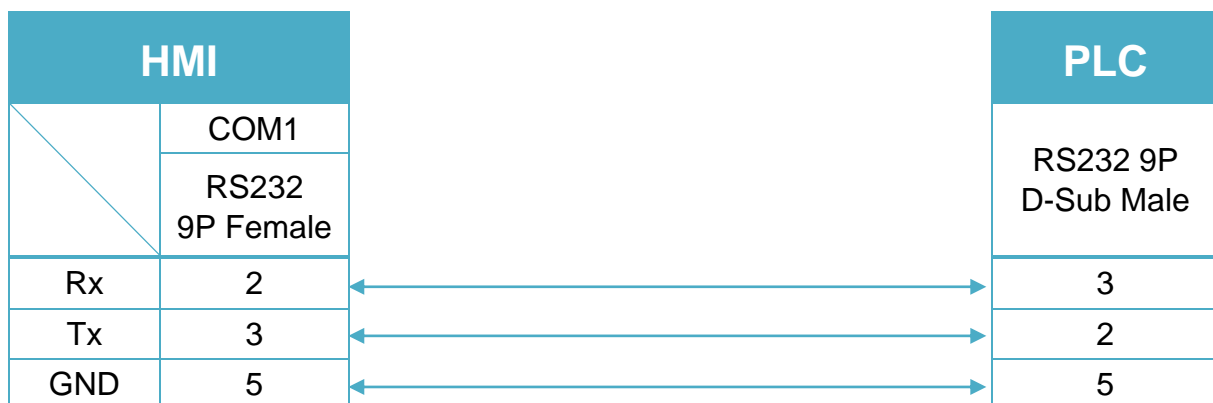
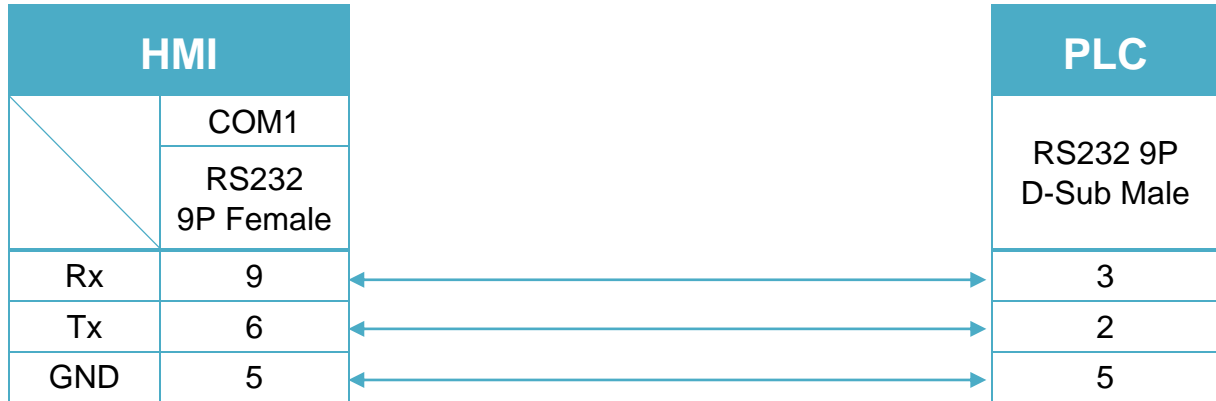


Diagram 7
MT-iE *MT8050iE*
MT-iP *MT6051iP / MT6071iP / MT8071iP*


VIGOR VS Series

Supported Series: VIGOR VS Series.

Website: <http://www.vigorplc.com.tw/>

HMI Setting:

Parameters	Recommended	Options	Notes
PLC type	VIGOR VS Series		
PLC I/F	RS485 2W	RS232, RS485 2W, USB	
Baud rate	19200	300 ~ 115200	
Data bits	8		
Parity	None		
Stop bits	1		
PLC sta. no.	0	0 ~ 254	

*Support communications between HMI and PLC in pass-through mode

*Set LW-9903 to 2 to enhance the speed of download/upload PLC program in pass-through mode

PLC Setting:

Protocol	VS Computer Link Slave

Device Address:

Bit/Word	Device type	Format	Range	Memo
B	X	OOO	0 ~ 571	
B	Y	OOO	0 ~ 571	
B	M	DDDD	0 ~ 8191	
B	S	DDDD	0 ~ 4095	
B	SM	DDDD	9000 ~ 9511	
B	D_Bit	DDDDh	0 ~ 8999f	
B	R_Bit	DDDDDh	0 ~ 25999f	
B	T_Coil	DDD	0 ~ 511	
B	T_Contact	DDD	0 ~ 511	
B	C_Coil	DDD	0 ~ 255	
B	C_Contact	DDD	0 ~ 255	
W	XW	OO	0 ~ 21	

Bit/Word	Device type	Format	Range	Memo
W	YW	OO	0 ~ 21	
W	MW	DDD	0 ~ 511	
W	SW	DDD	0 ~ 255	
W	D	DDDD	0 ~ 8999	
W	SD	DDDD	9000 ~ 9511	
W	R	DDDDD	0 ~ 25999	
W	T	DDD	0 ~ 511	
W	C	DDD	0 ~ 199	
DW	C_32Bit	DDD	200 ~ 255	

Wiring Diagram:

CP1 RS-485 2W Terminal (Diagram1~ Diagram6)

Diagram 1

cMT Series

cMT3151

eMT Series

eMT3070 / eMT3105 / eMT3120 / eMT3150

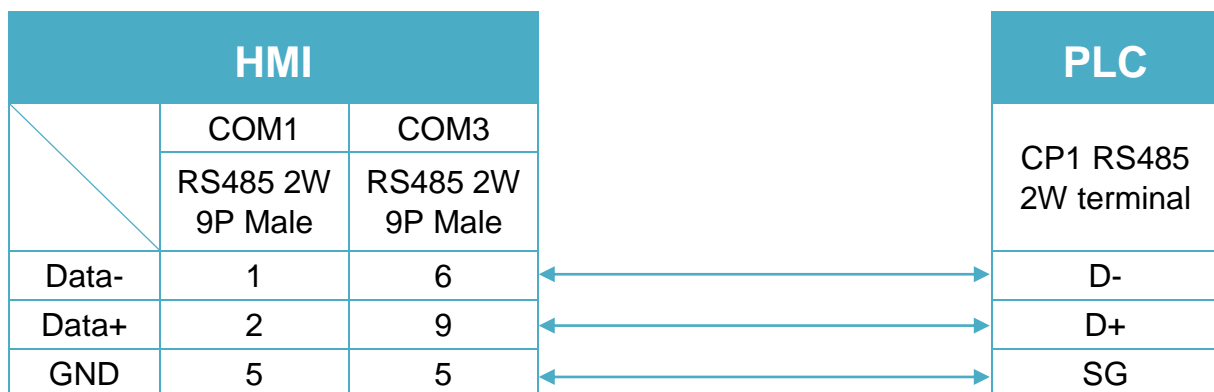


Diagram 2

cMT Series *cMT-SVR*

mTV *mTV*

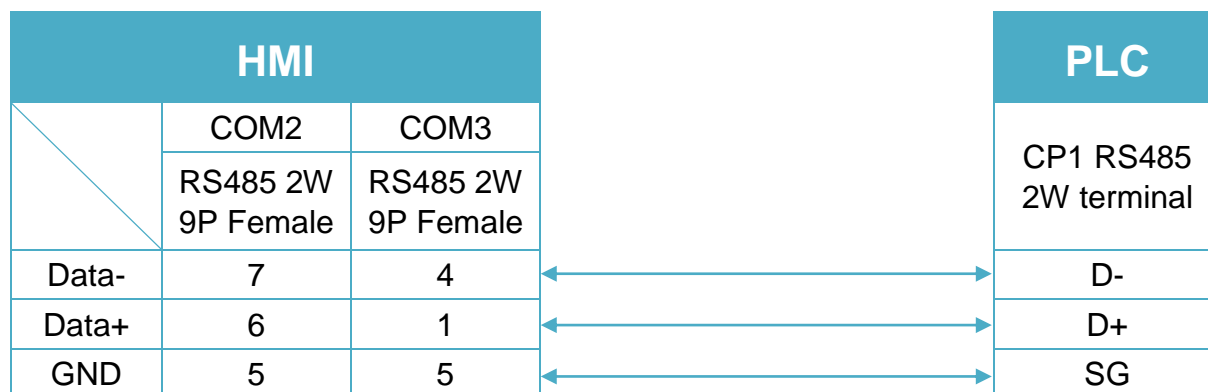


Diagram 3

MT-iE *MT8070iE / MT6070iE / MT8100iE / MT8121iE / MT8150iE*

MT-XE *MT8121XE / MT8150XE*

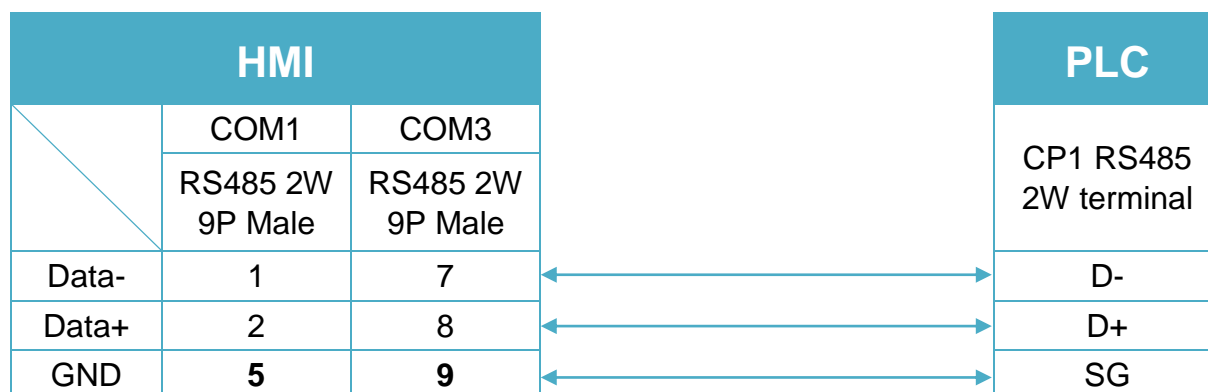


Diagram 4

MT-iE	<i>MT8071iE / MT6071iE / MT8072iE / MT6072iE / MT8073iE / MT8101iE / MT8102iE / MT8103iE</i>
MT-XE	<i>MT8090XE / MT8092XE</i>
MT-iP	<i>MT6103iP</i>

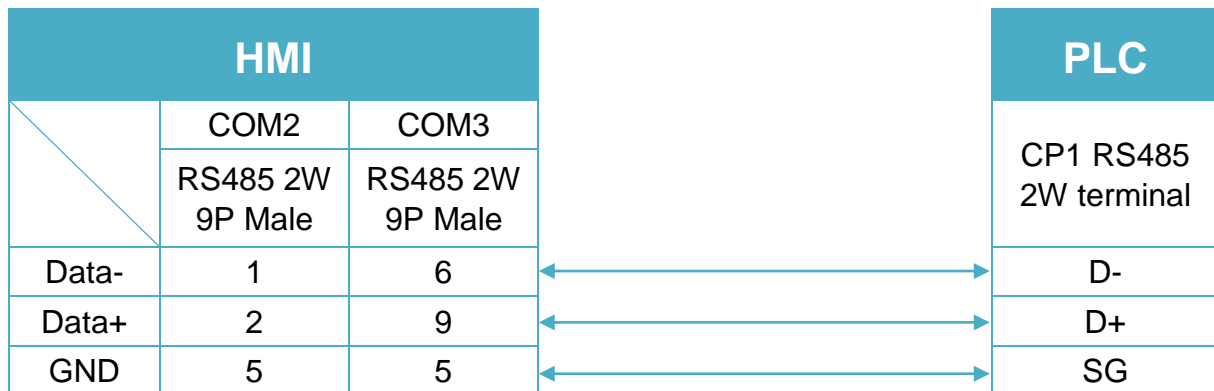


Diagram 5

MT-iE	<i>MT8050iE</i>
MT-iP	<i>MT6051iP</i>

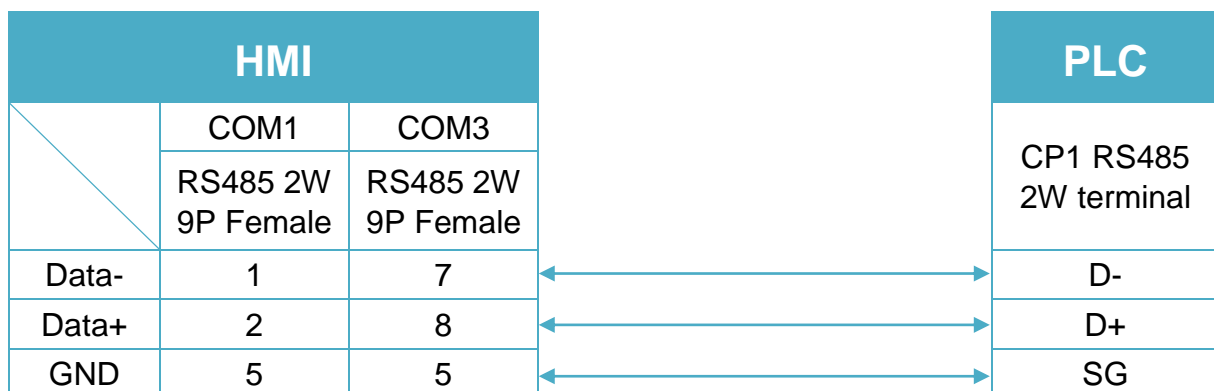


Diagram 6

MT-iP **MT6071iP / MT8071iP**



CP2 RS-232 Terminal (Diagram7~ Diagram9)

Diagram 7

cMT Series	cMT3151
eMT Series	eMT3070/ eMT3105 / eMT3120 / eMT3150
MT-iE	MT8073iE / MT8102iE
MT-XE	MT8092XE
MT-iP	MT6103iP

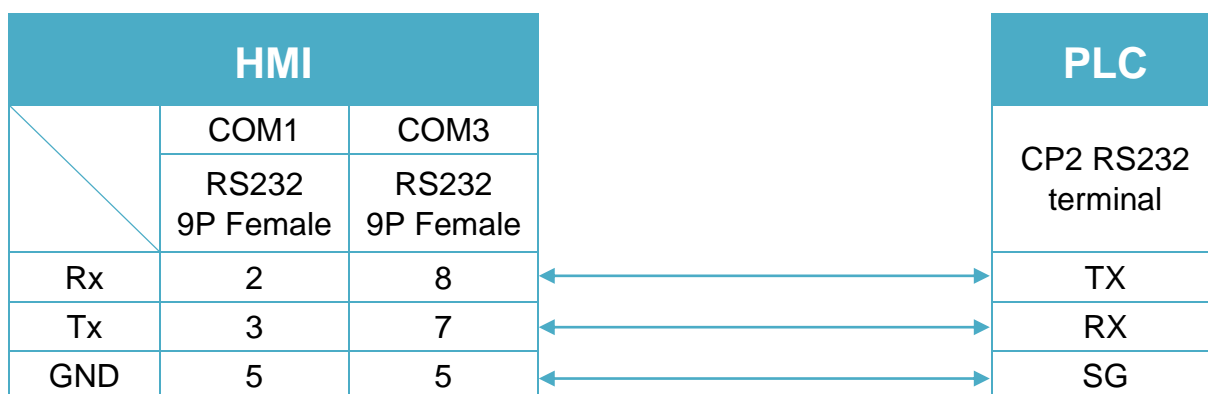


Diagram 8

cMT Series	cMT-SVR
mTV	mTV
MT-iE	MT8070iE / MT6070iE / MT8100iE / MT8121iE / MT8150iE / MT8071iE / MT6071iE / MT8072iE / MT6072iE / MT8073iE / MT8101iE / MT8102iE / MT8103iE
MT-XE	MT8121XE / MT8150XE / MT8090XE

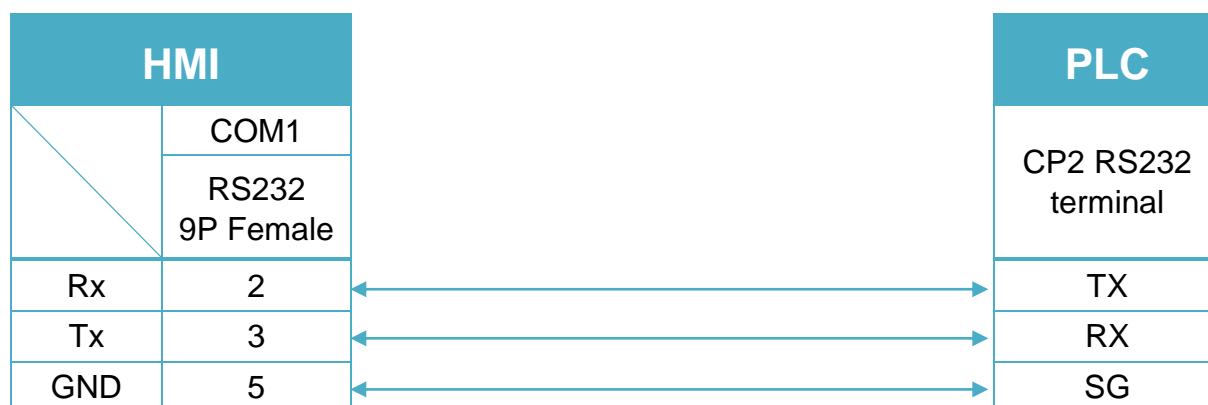
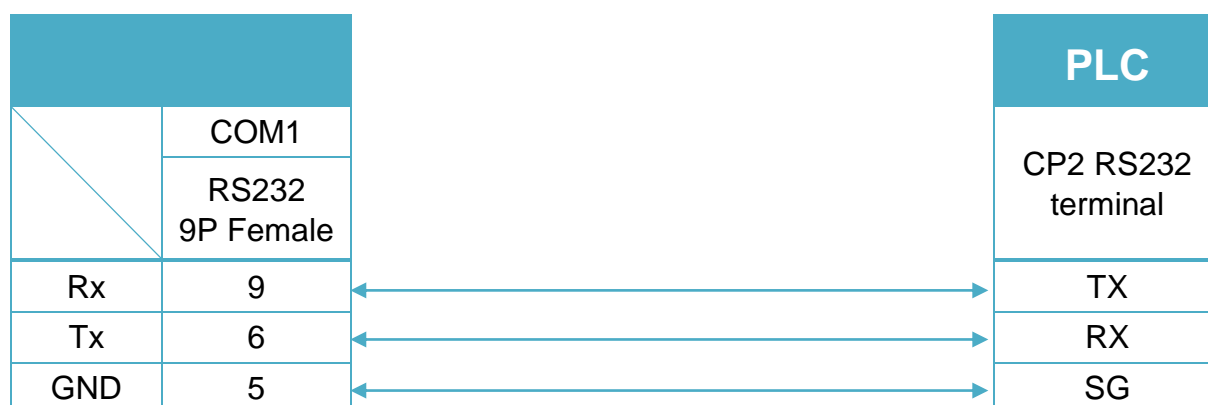


Diagram 9

MT-iE	MT8050iE
MT-iP	MT6051iP / MT6071iP / MT8071iP



VIPA 200, for ex. 214-2BT10 (Ethernet)

HMI Setting:

Parameters	Recommended	Options	Notes
PLC type	VIPA 200, for ex. 214-2BT10 (Ethernet)		
PLC I/F	Ethernet		
Port no.	102		
PLC sta. no.	1	0-31	

Device Address:

Bit/Word	Device	Format	Range	Memo
B	I	DDDDo	0 ~ 40957	Input (I)
B	Q	DDDDo	0 ~ 40957	Output (O)
B	M	DDDDo	0 ~ 40957	Bit Memory
B	VW_Bit	DDDDDo	0 ~ 102397	V Memory Bit Address
W	VW	DDDDD	0 ~ 10239	V Memory
DW	VD	DDDDD	0 ~ 10239	V Memory Double Word
W	VW_String	DDDDD	0 ~ 10239	String
DW	VD_String	DDDDD	0 ~ 10239	String
DW	MD	DDDDD	0 ~ 10239	Word Memory

- Double word and floating point value must use VD device type.

Wiring Diagram:

Ethernet cable:



VIPA 200/300 MPI

HMI Setting:

Parameters	Recommend	Options	Notes
PLC type	VIPA 200/300 MPI		
PLC I/F	RS-485 2W		
Baud rate	187.5K		Only HMI with a sticker "MPI 187.5K" on the rear cover supports MPI communication.
Data bits	8		
Parity	Even		
Stop bits	1		
PLC sta. no.	2	2 ~ 31	

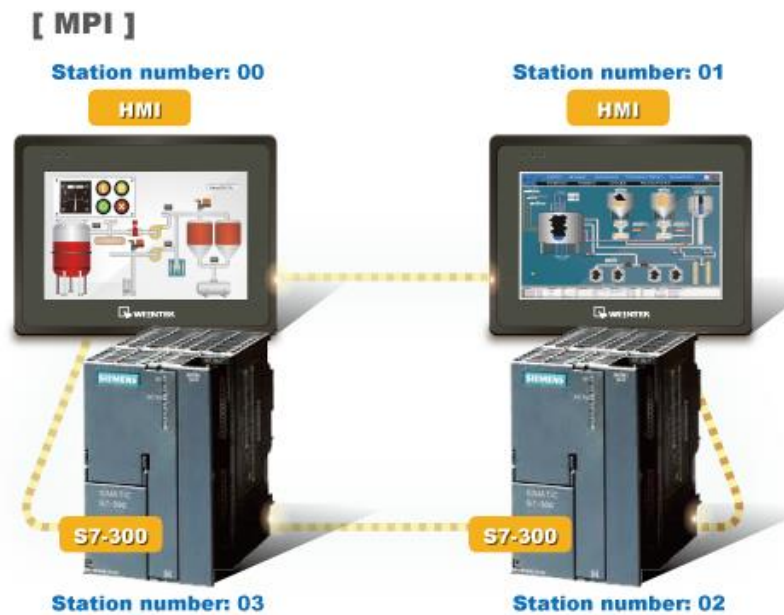
Online simulator	NO	Extend address mode	Yes
Broadcast command	NO		

Device Address:

Bit/Word	Device type	Format	Range	Memo
B	I	DDDDo	0 ~ 40957	Input (I)
B	Q	DDDDo	0 ~ 40957	Output (O)
B	M	DDDDo	0 ~ 40957	Bit Memory
B	DBnBit	FFFFDDDDo	0 ~ 409699997	Data Register Bit
B	DB0Bit ~DB99Bit	DDDDDo	0 ~ 655327	Data Register Bit
W	IW	DDDD	0 ~ 4095	Input (I)
W	QW	DDDD	0 ~ 4095	Output (O)
W	MW	DDDD	0 ~ 4095	Bit Memory
DW	MD	DDDD	0 ~ 4094	
Byte	MB	DDDD	0 ~ 4095	Bit Memory Byte
Byte	DBBn	FFFFDDDD	0 ~ 40969999	Data Register
W	DBn	FFFFDDDD	0 ~ 40969999	Data Register (must be even)
DW	DBDn	FFFFDDDD	0 ~ 40969999	Data Register Double Word
W	DBn_String	FFFFDDDD	0 ~ 40969999	
DW	DBDn_String	FFFFDDDD	0 ~ 40969999	
W	DB0 ~ DB99	DDDD	0 ~ 65532	Data Register (must be even)

* Double word and floating point value must use DBDn device type.

Multi-HMIs-Multi-PLCs Communication Setting:



For SIEMENS S7-300 MPI driver in Multi-HMIs-Multi-PLCs communication, [Max. station no. (MPI network)] parameter must be correctly set. This setting is relevant to the station no. of the devices, as shown, two HMI (station no. 0, 1) and two PLC (station no. 2, 3) are in MPI network, Max. Station No. should be set to 3.

Device Properties

Name : SIEMENS S7-300 MPI

HMI PLC

Location : Local Settings ...

PLC type : SIEMENS S7-300 MPI ▼
V.2.00, SIEMENS_S7_300_MPI.so

PLC I/F : RS-485 2W ▼

COM : COM1 (187.5K,E,8,1) Settings...

PLC default station no. : 2

Default station no. use station no. variable

Max. station no. (MPI network) : 3 ▼

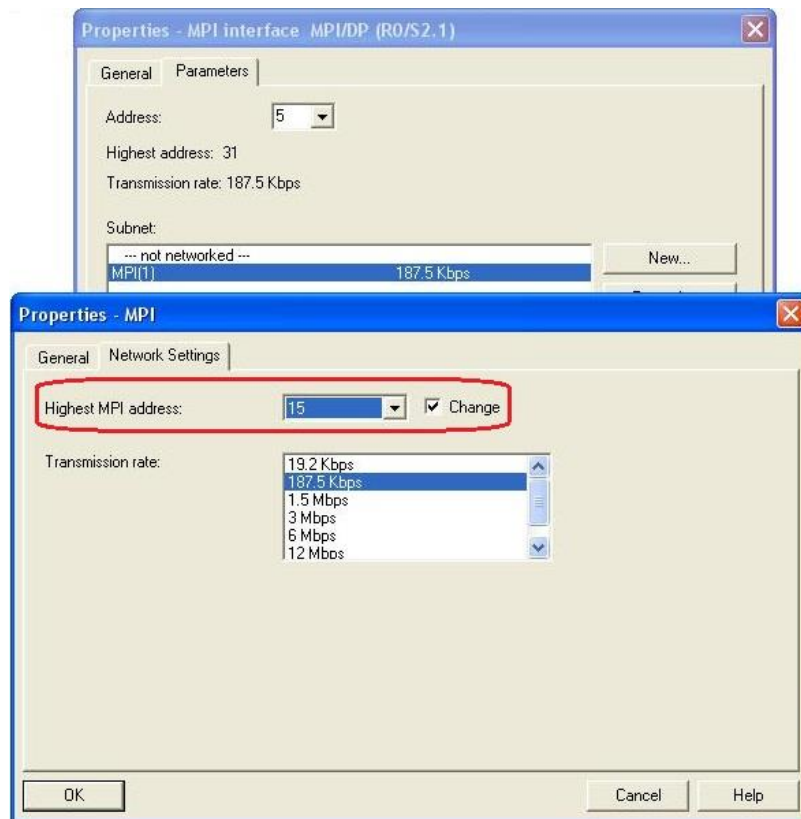
Interval of block pack (words) : 5 ▼

Max. read-command size (words) : 20 ▼

Max. write-command size (words) : 20 ▼

OK Cancel

For the effectiveness of communication, users may set PLC device in STEP 7 as shown below. In Properties MPI / Network Settings, set Highest MPI address to the number closest to the actual device station number.



Note:

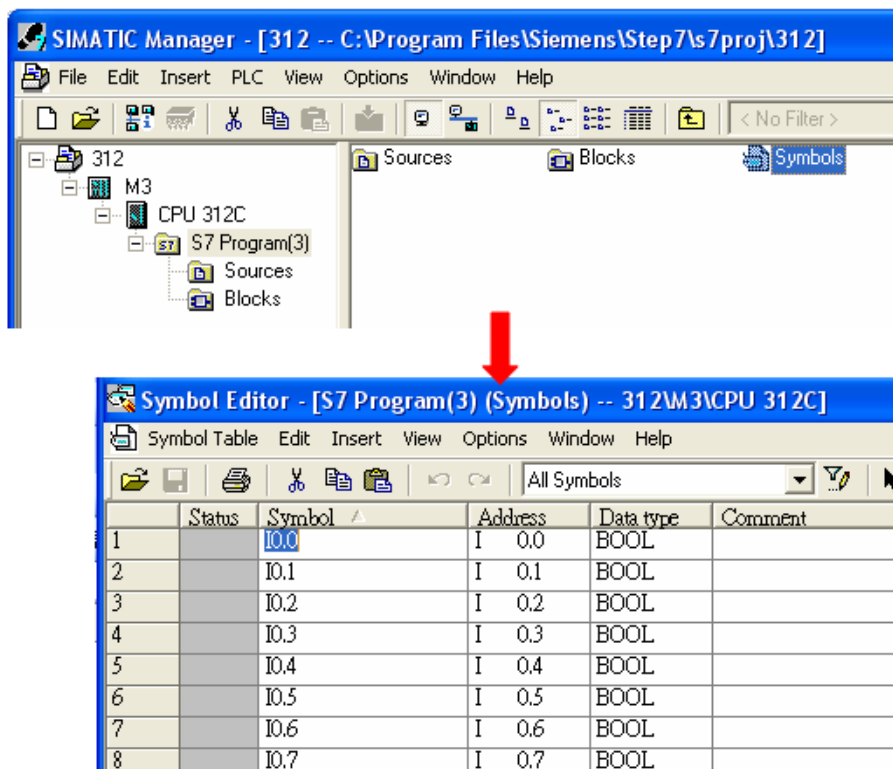
- HMI sta. no. can not be the same as PLC sta. no.
- Highly recommended that the device station numbers start from 0 sequentially and correctly set [Max. station no. (MPI network)].
- Available for EasyBuilder V4.50 and later.

How to Import Tag:

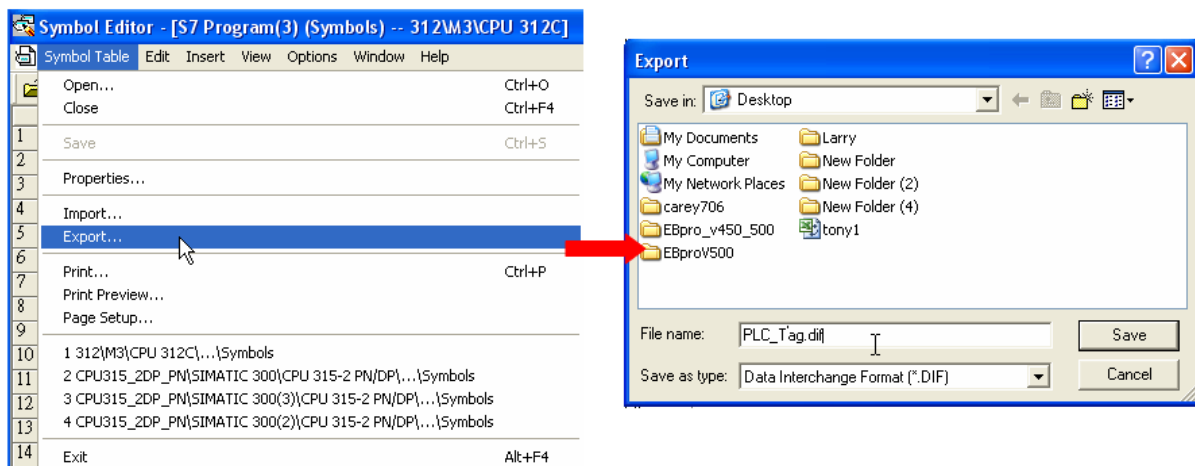
SIEMENS STEP 7 program allows building files of user-defined tag (*.dif file and *.AWL file), and import these files in EasyBuilder8000/EasyBuilderPro -> System Parameter Settings. The following describes how to build and import these two types of files.

1. Building *.dif File

- a. In "Symbols" create user-defined tag.

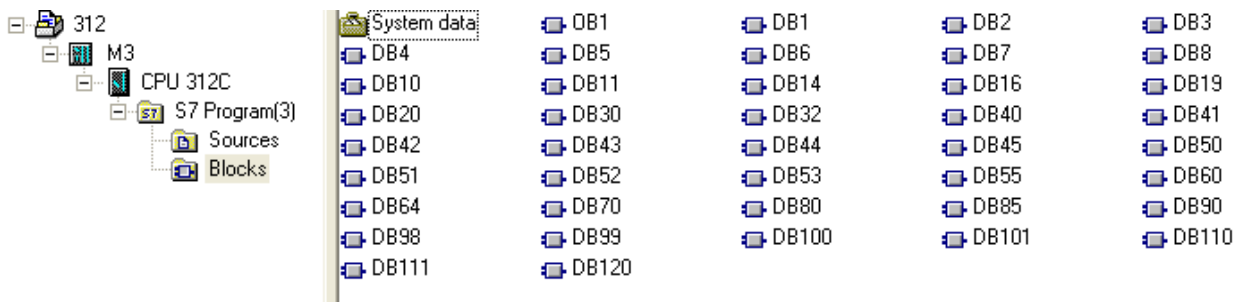


- b. Click **Export** to export the edited file and click **Save**.

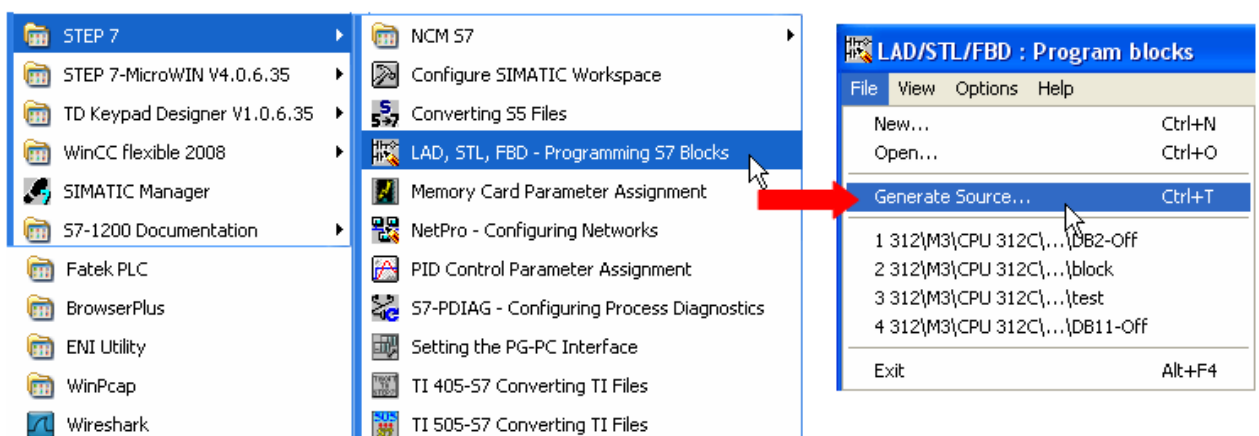


2. Building *.AWF File

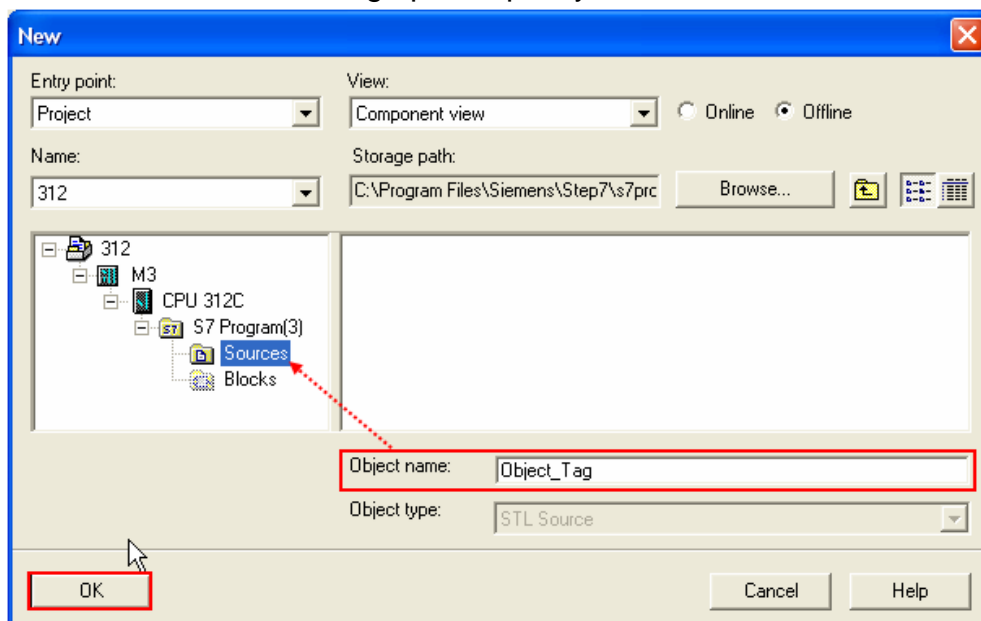
a、 In **Blocks** create items as shown below:



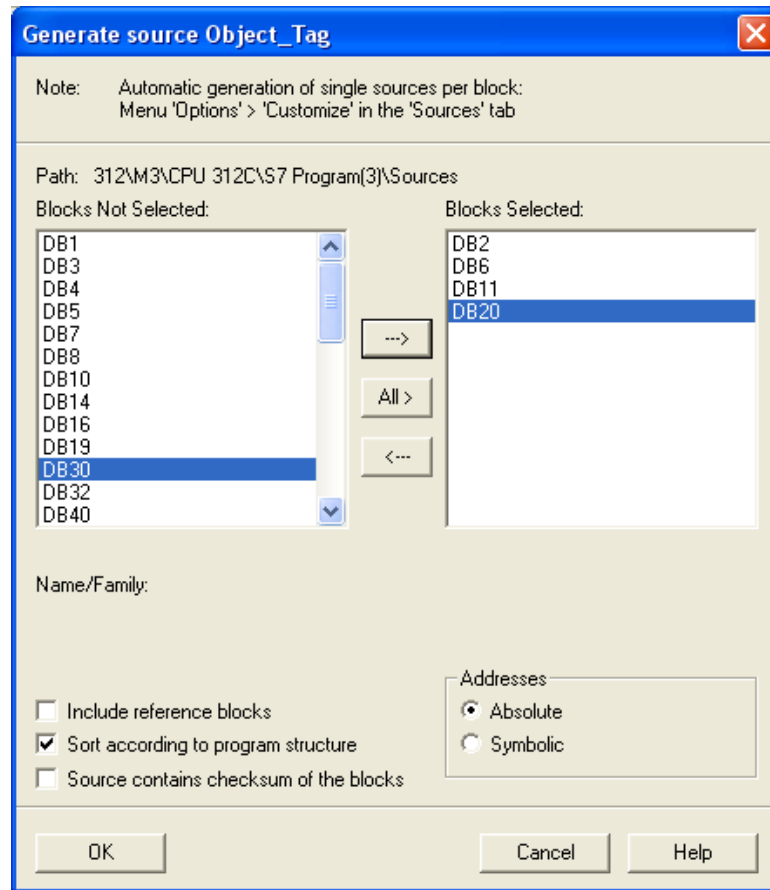
b、 Open **LAD/STL, FBD – Programming S7 Blocks**, click **File -> Generate Source**.



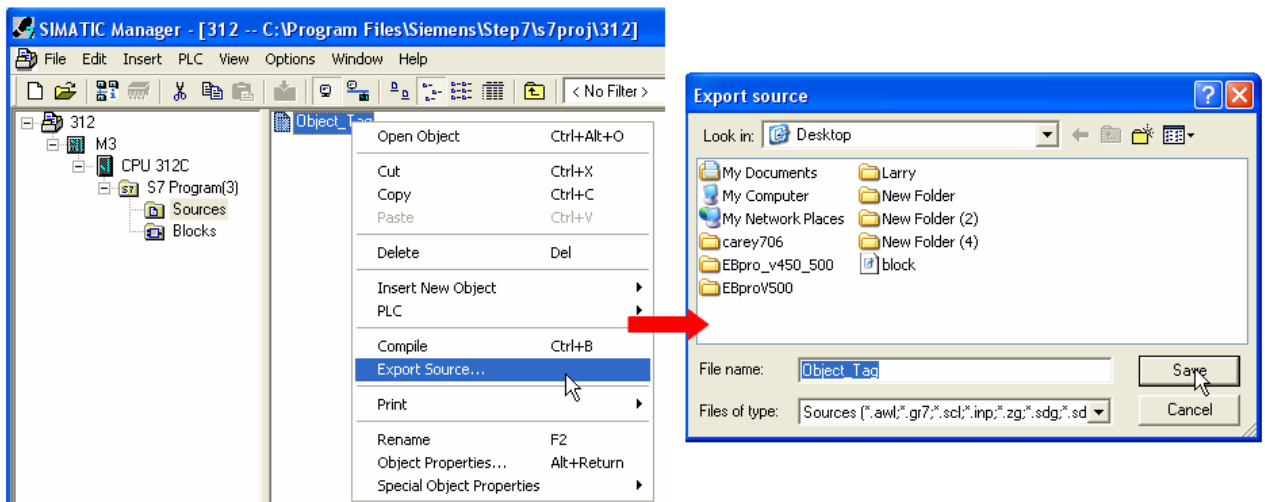
c、 Select **Sources** as storage path, specify the file name then click **OK**.



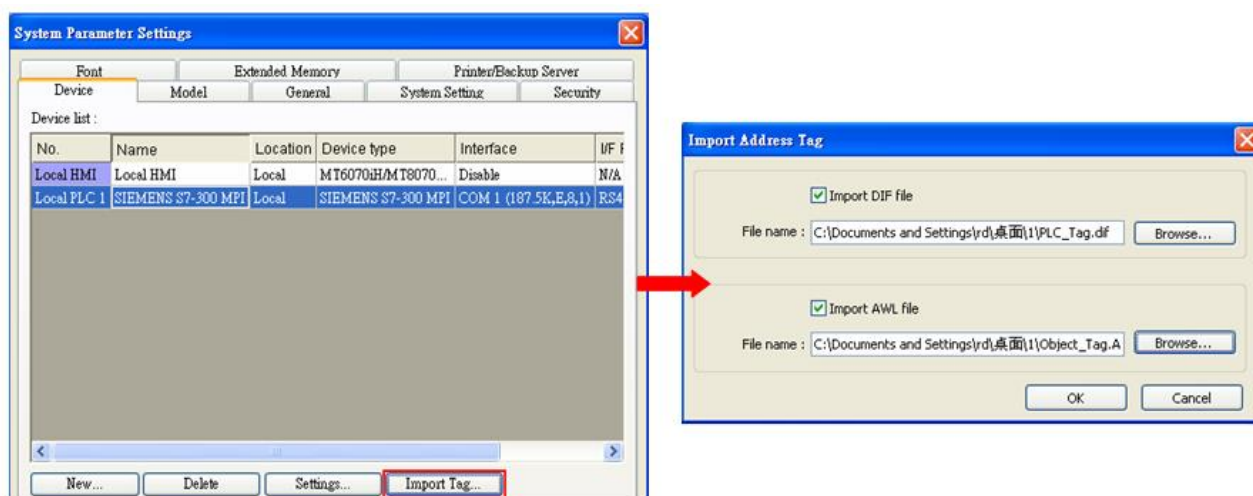
- d、 Select the objects to be exported then click **OK**.



- e、 Under **Sources** there will be names of the saved files, select **Export Source** to build *.AWL file.



The generated *.dif and *.AWL files can be imported in EasyBuilder8000/EasyBuilderPro **System Parameter Settings**, by clicking **Import Tag**.



Tag information successfully imported.



Wiring Diagram:

RS-485 2W 9P D-Sub (Diagram1~ Diagram6)

Diagram 1

cMT Series

cMT3151

eMT Series

eMT3070/ eMT3105 / eMT3120 / eMT3150

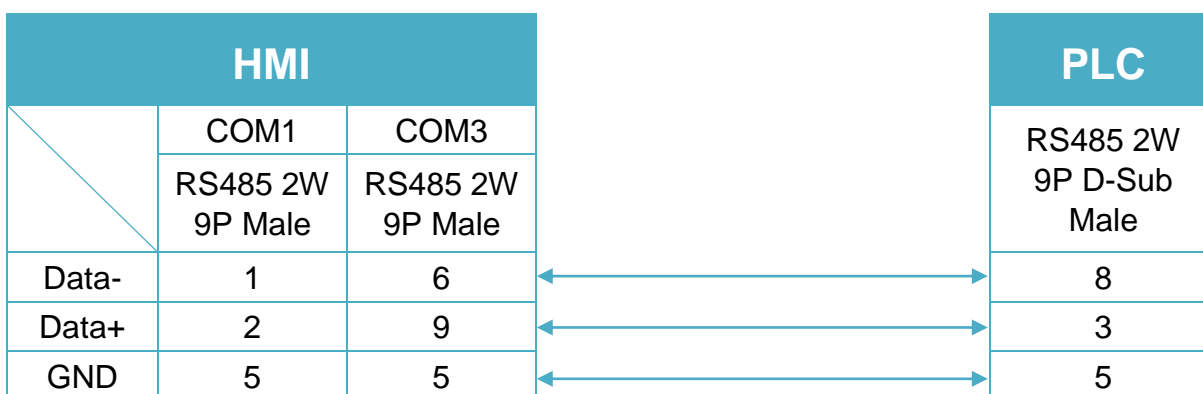


Diagram 2

cMT Series *cMT-SVR*

mTV *mTV*

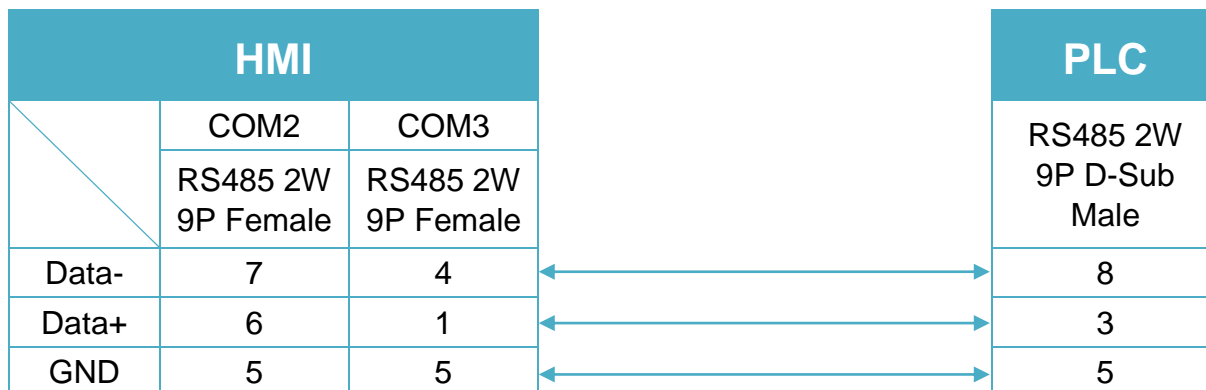


Diagram 3

MT-iE *MT8070iE / MT6070iE / MT8100iE / MT8121iE / MT8150iE*

MT-XE *MT8121XE / MT8150XE*

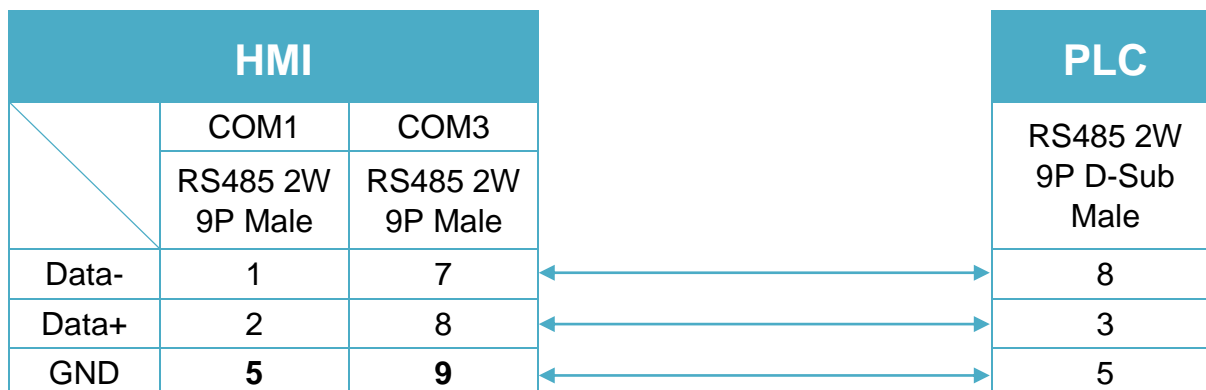
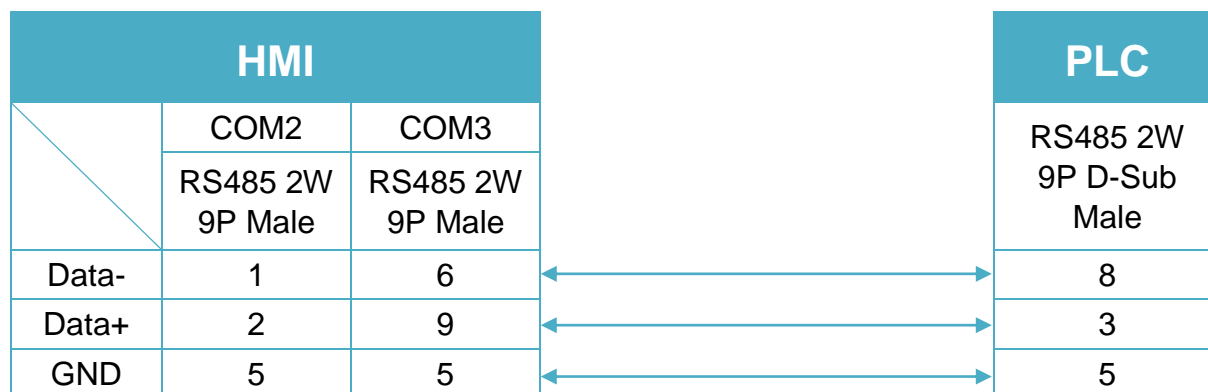
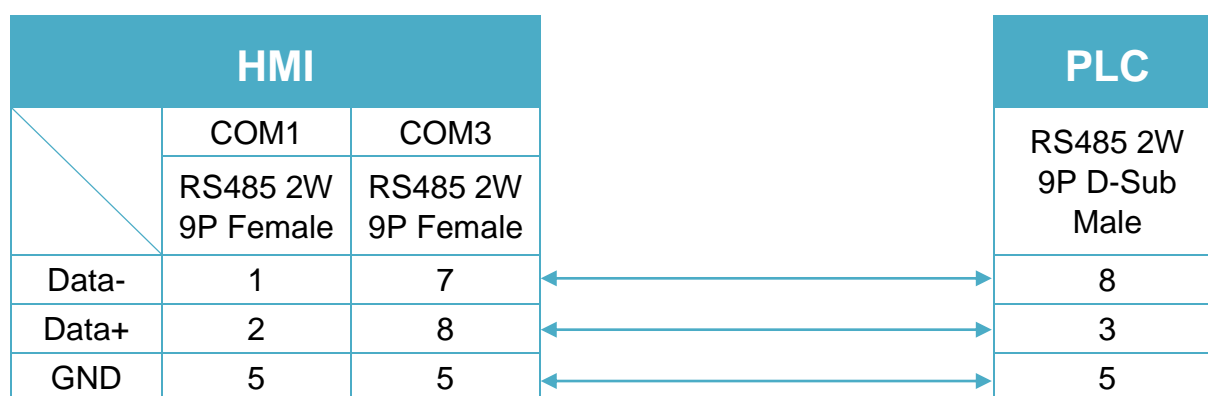
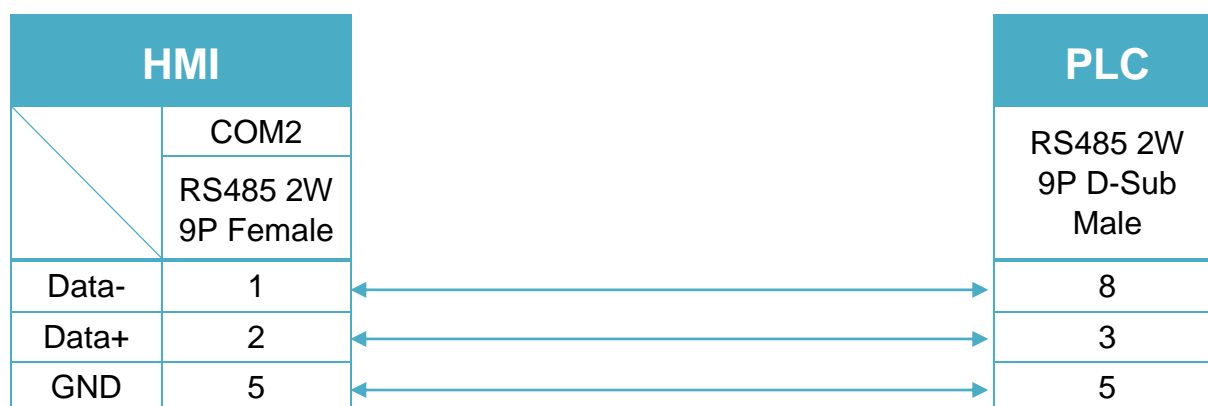


Diagram 4

MT-iE *MT8071iE / MT6071iE / MT8072iE / MT6072iE / MT8073iE /
MT8101iE / MT8102iE / MT8103iE*

MT-XE *MT8090XE / MT8092XE*

MT-iP *MT6103iP*


Diagram 5
MT-iE *MT8050iE*
MT-iP *MT6051iP*

Diagram 6
MT-iP *MT6071iP / MT8071iP*


VIPA 300S (Ethernet)

HMI Setting:

Parameters	Recommended	Options	Notes
PLC type	VIPA 300S (Ethernet)		
PLC I/F	Ethernet		
Port no.	102		
Link type	PG	PC, OP	
Rack	0	0-7	
CPU slot	3	2-31	
PLC sta. no.	0	0-31	

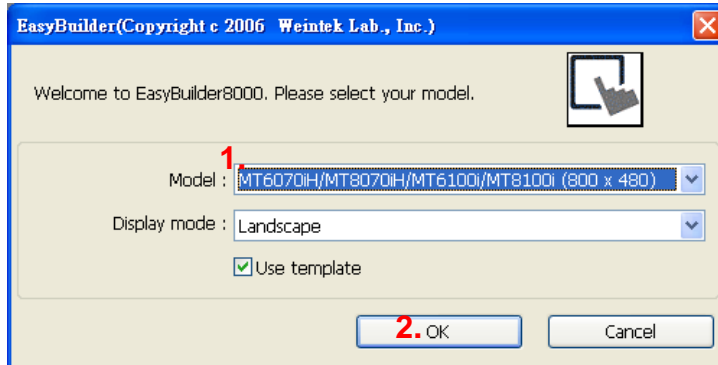
Device Address:

Bit/Word	Device type	Format	Range	Memo
B	I	DDDDo	0 ~ 40957	Input (I)
B	Q	DDDDo	0 ~ 40957	Output (O)
B	M	DDDDo	0 ~ 40957	Bit Memory
B	DBnBit	FFFFFFDDDDo	0 ~ 6553599997	
B	DB0Bit-DB99Bit	DDDDDo	0 ~ 655327	Data Register Bit
W	IW	DDDD	0 ~ 4095	Input (I)
W	QW	DDDD	0 ~ 4095	Output (O)
W	MW	DDDD	0 ~ 4095	Bit Memory
DW	MD	DDDD	0 ~ 4094	
W	DBn	FFFFFFDDDD	0 ~ 655359999	Data Register (must be even)
DW	DBDn	FFFFFFDDDD	0 ~ 655359999	Data Register Double Word
W	DBn_String	FFFFFFDDDD	0 ~ 655359999	
DW	DBDn_String	FFFFFFDDDD	0 ~ 655359999	
W	DB0 ~ DB99	DDDDD	0 ~ 65532	Data Register
Byte	MB	DDDD	0 ~ 4095	Bit Memory Byte
Byte	DBBn	FFFFFFDDDD	0 ~ 655359999	Data Register Byte

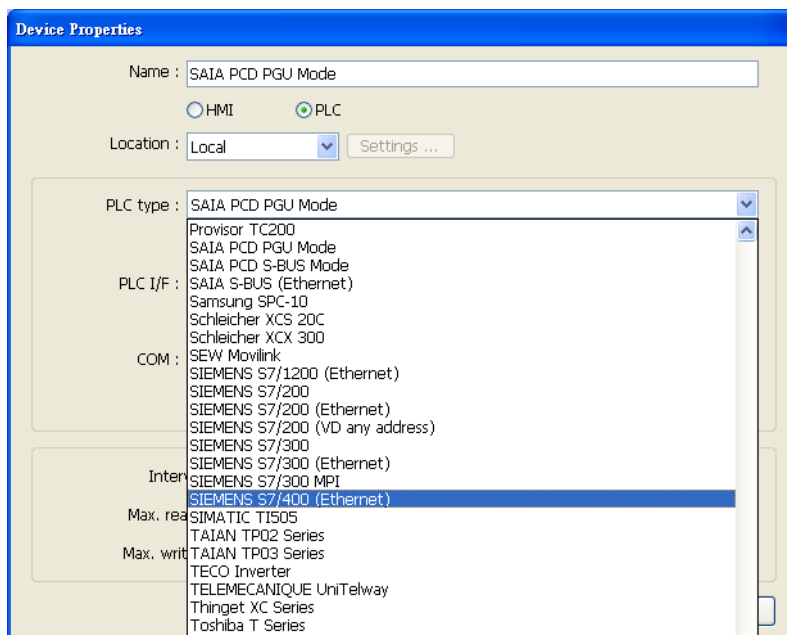
* Double word and floating point value must use DBDn device type.

EasyBuilder Device Setting Steps

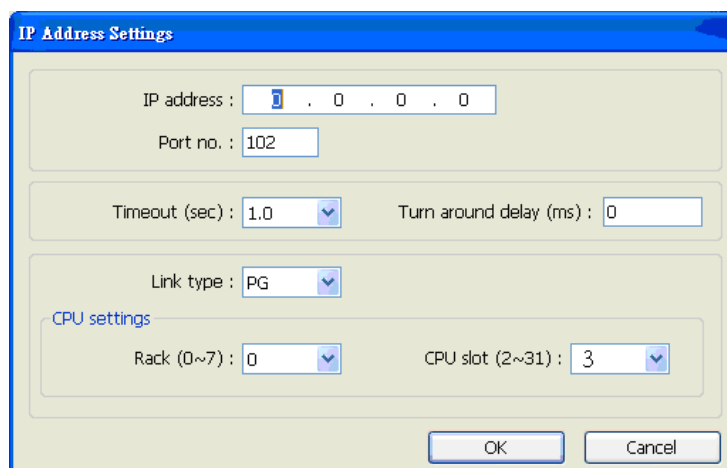
1. Open EasyBuilder, File/NEW, select HMI model and press [OK].



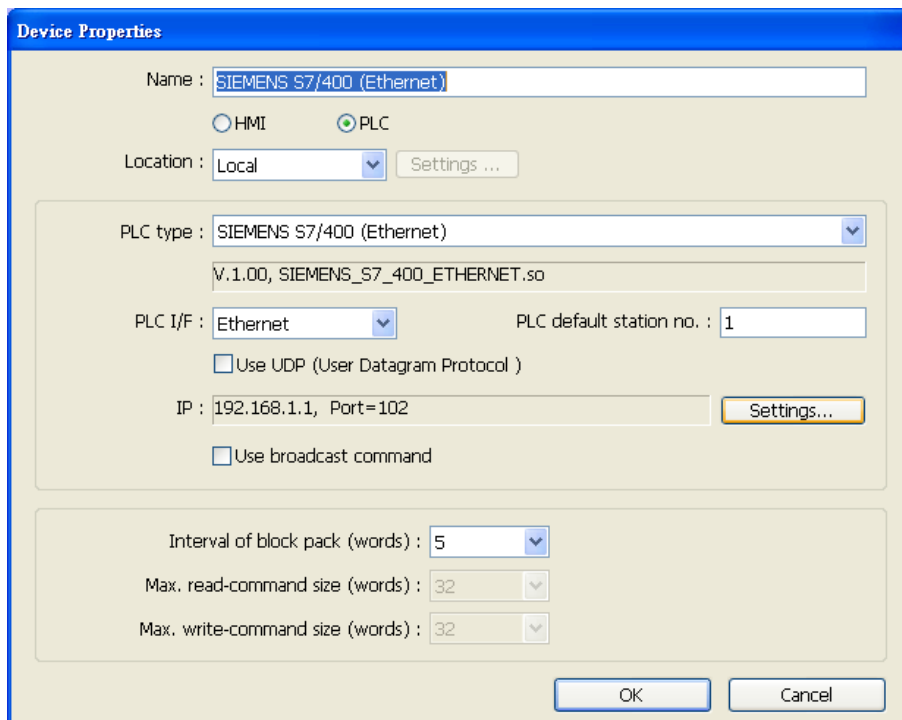
2. "System Parameter Settings" window is shown, click [New].
3. Select "SIEMENS S7-400(ETHERNET)".



4. Press [Settings].
5. Set S7-400 IP, Port no., Link type, Rack and CPU slot. (must match PLC settings)



6. The setting will be finished as below.

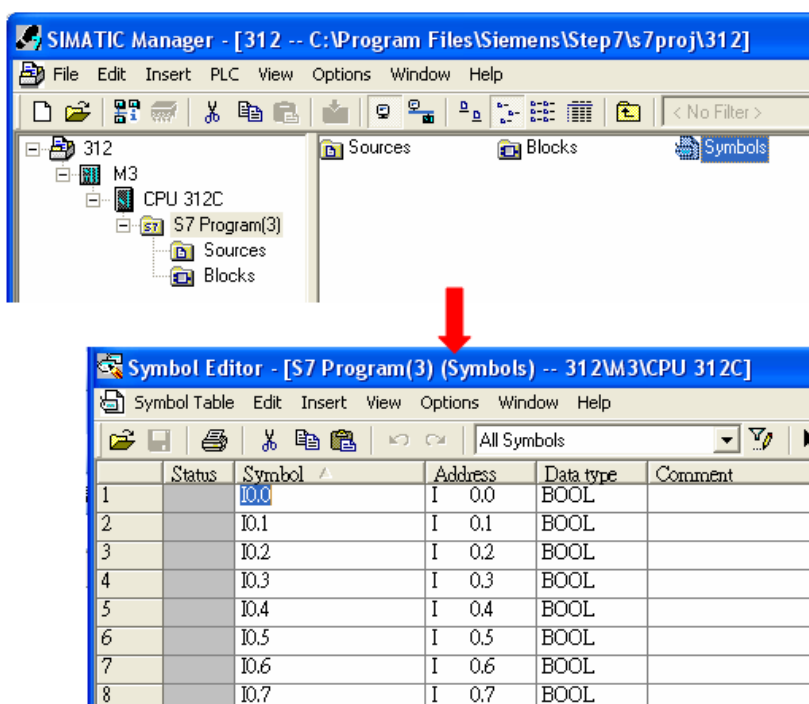


How to Import Tag:

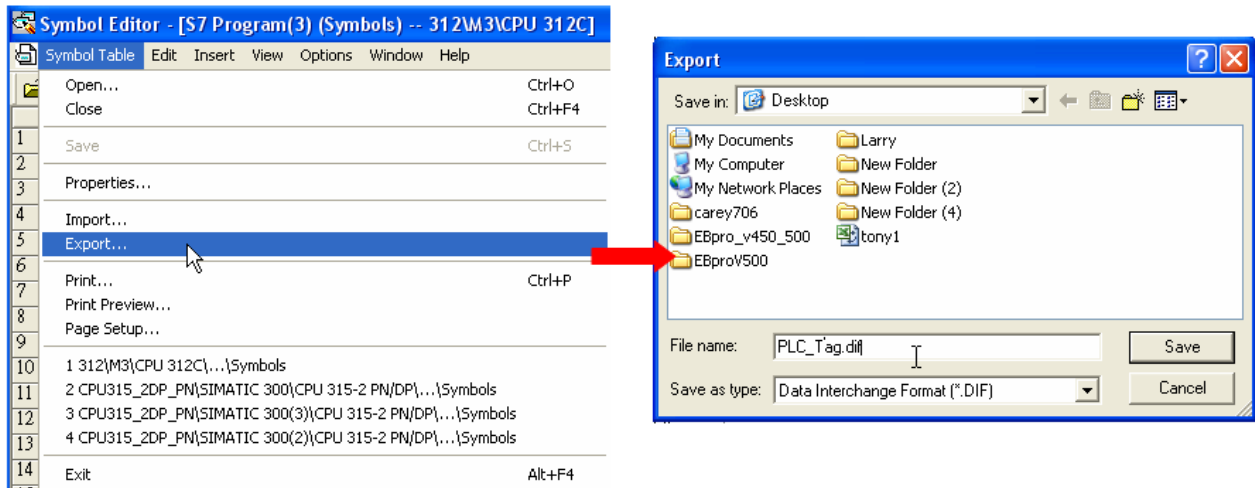
SIEMENS STEP 7 program allows building files of user-defined tag (*.dif file and *.AWL file), and import these files in EasyBuilder8000/EasyBuilderPro -> System Parameter Settings. The following describes how to build and import these two types of files.

1. Building *.dif File

a. In "Symbols" create user-defined tag.

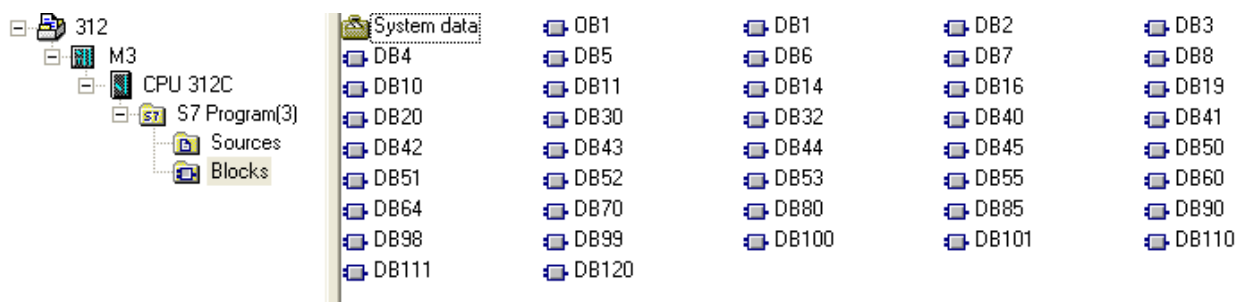


b. Click **Export** to export the edited file and click **Save**.

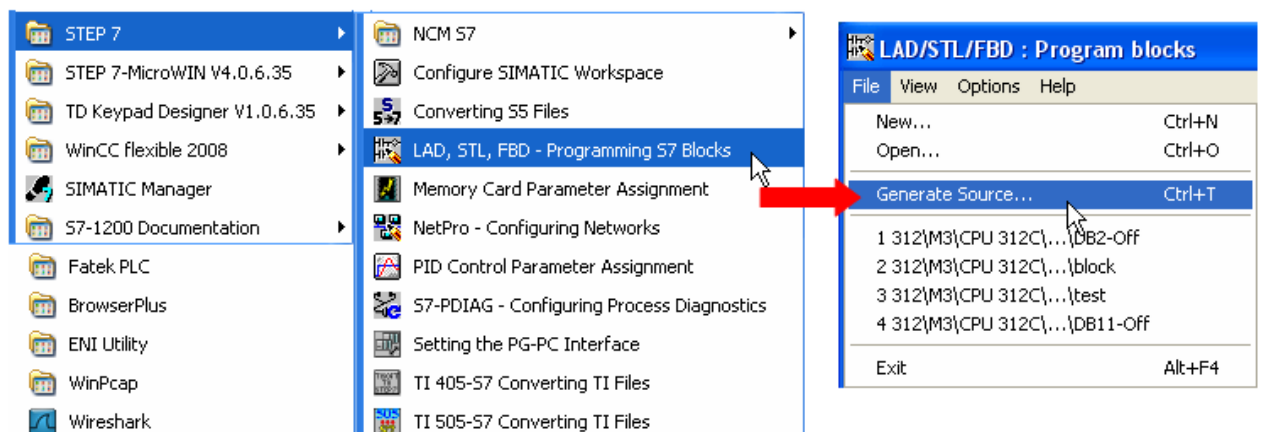


2. Building *.AWF File

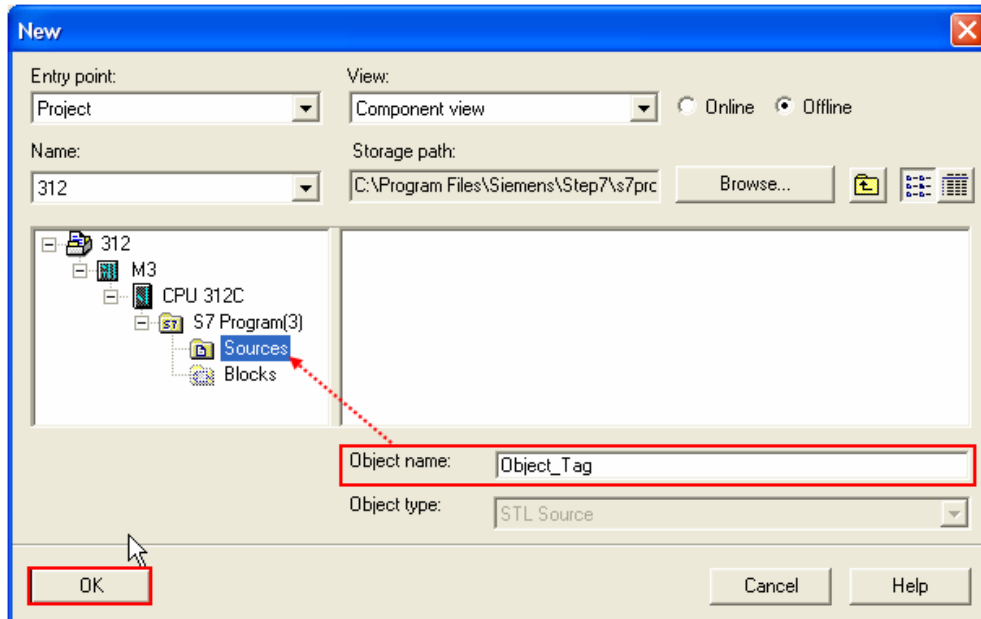
a. In **Blocks** create items as shown below:



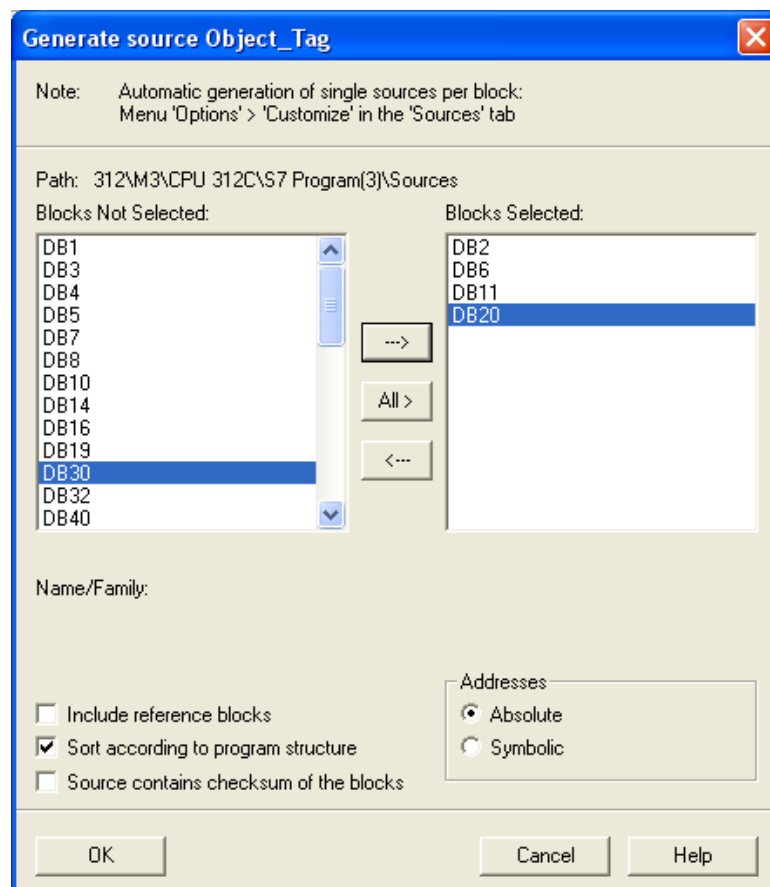
b. Open LAD/STL, FBD – Programming S7 Blocks, click **File** -> **Generate Source**.



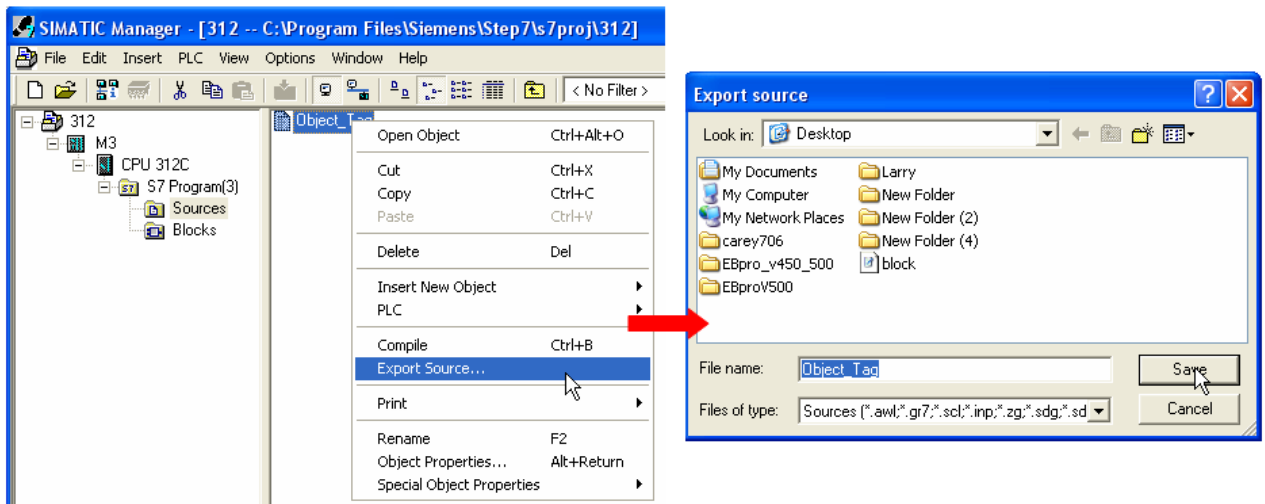
- c ․ Select **Sources** as storage path, specify the file name then click **OK**.



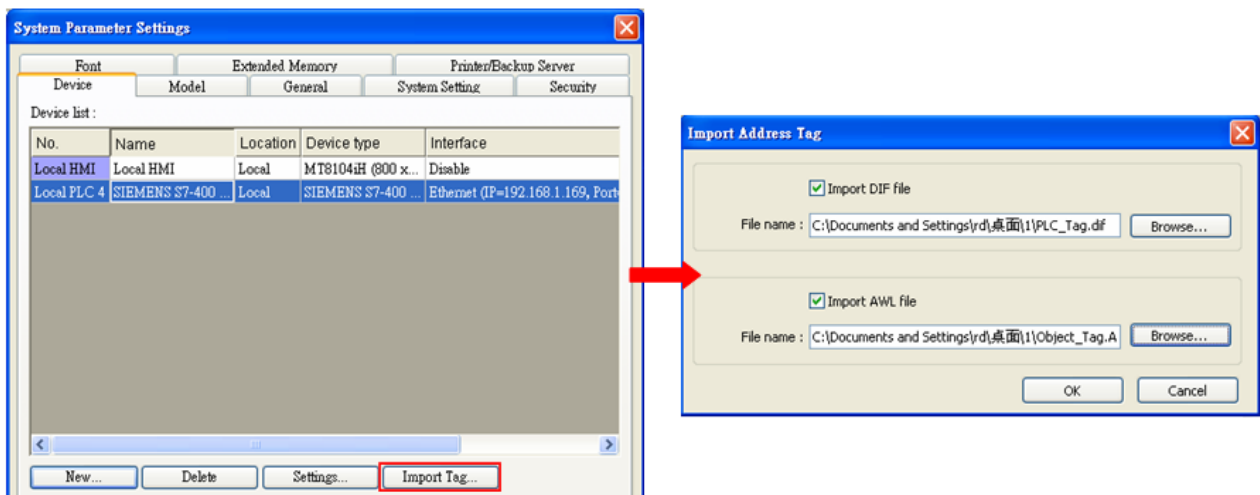
- d ․ Select the objects to be exported then click **OK**.



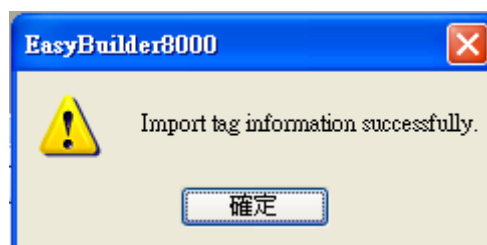
e、 Under **Sources** there will be names of the saved files, select **Export Source** to build *.AWL file.



The generated *.dif and *.AWL files can be imported in EasyBuilder8000/EasyBuilderPro **System Parameter Settings**, by clicking **Import Tag**.



Tag information successfully imported.



Wiring Diagram:

Ethernet cable:



VIPA 300S, for ex. 315-4NE12 (Ethernet)

HMI Setting:

Parameters	Recommended	Options	Notes
PLC type	VIPA 300S, for ex. 315-4NE12 (Ethernet)		
PLC I/F	Ethernet		
Port no.	102		
PLC sta. no.	1	0-31	

Device Address:

Bit/Word	Device type	Format	Range	Memo
B	I	DDDDo	0 ~ 40957	Input (I)
B	Q	DDDDo	0 ~ 40957	Output (O)
B	M	DDDDo	0 ~ 40957	Bit Memory
B	DBnBit	FFFFDDDDo	0 ~ 409699997	
B	DB0Bit-DB99Bit	DDDDDo	0 ~ 655327	Data Register Bit
W	IW	DDDD	0 ~ 4095	Input (I)
W	QW	DDDD	0 ~ 4095	Output (O)
W	MW	DDDD	0 ~ 4095	Bit Memory
DW	MD	DDDD	0 ~ 4094	Bit Memory Double Word
W	DBn	FFFFDDDD	0 ~ 40969999	Data Register (must be even)
DW	DBDn	FFFFDDDD	0 ~ 40969999	Data Register Double Word
W	DBn_String	FFFFDDDD	0 ~ 40969999	
DW	DBDn_String	FFFFDDDD	0 ~ 40969999	
W	DB0 ~ DB99	DDDD	0 ~ 65532	Data Register (must be even)
Byte	MB	DDDD	0 ~ 4095	Bit Memory Byte
Byte	DBBn	FFFFDDDD	0 ~ 40969999	Data Register Byte

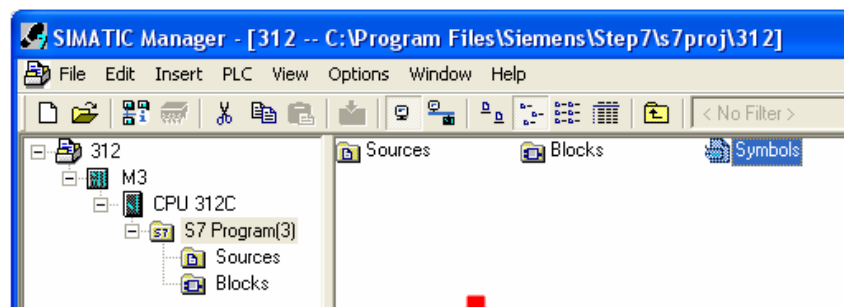
- Double word and floating point value must use DBDn device type.

How to Import Tag:

SIEMENS STEP 7 program allows building files of user-defined tag (*.dif file and *.AWL file), and import these files in EasyBuilder8000/EasyBuilderPro -> System Parameter Settings. The following describes how to build and import these two types of files.

1. Building *.dif File

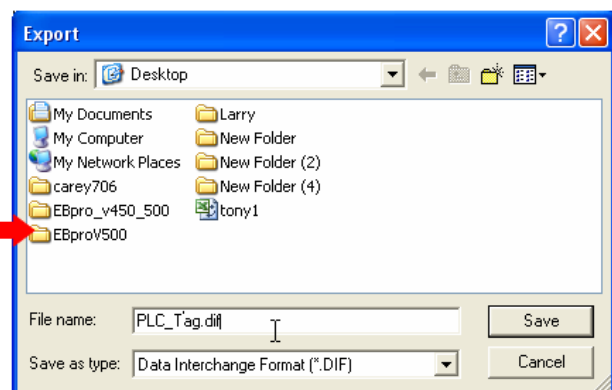
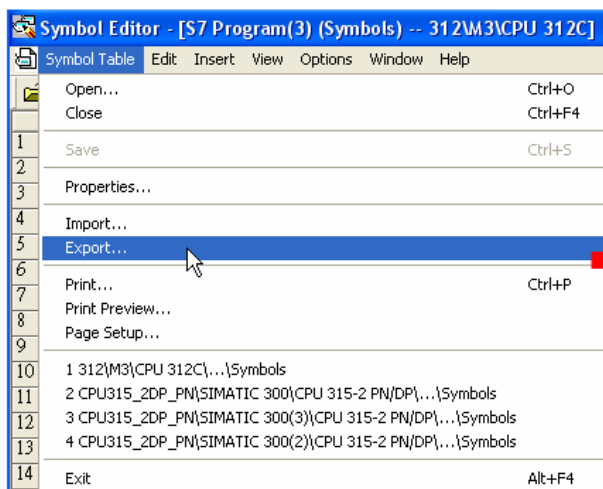
- a. In “Symbols” create user-defined tag.



The Symbol Editor window displays a table of symbols. A red arrow points from the 'S7 Program(3)' folder in the previous screenshot to this window. The table has columns for Status, Symbol, Address, Data type, and Comment.

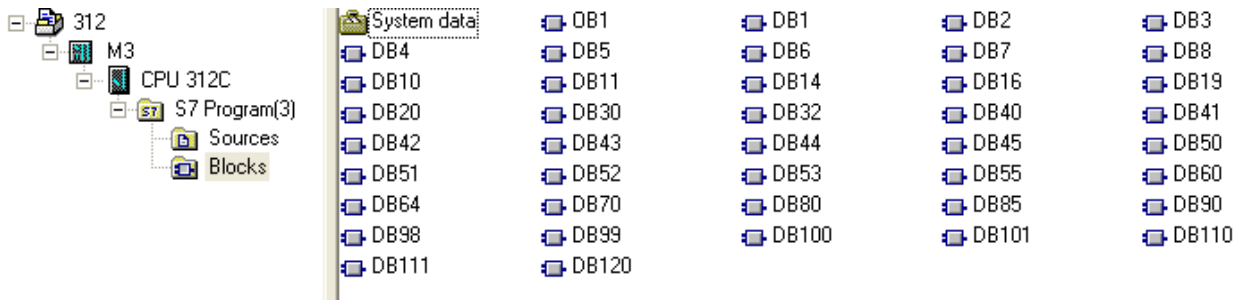
	Status	Symbol	Address	Data type	Comment
1		I0.0	I 0.0	BOOL	
2		I0.1	I 0.1	BOOL	
3		I0.2	I 0.2	BOOL	
4		I0.3	I 0.3	BOOL	
5		I0.4	I 0.4	BOOL	
6		I0.5	I 0.5	BOOL	
7		I0.6	I 0.6	BOOL	
8		I0.7	I 0.7	BOOL	

- b. Click **Export** to export the edited file and click **Save**.

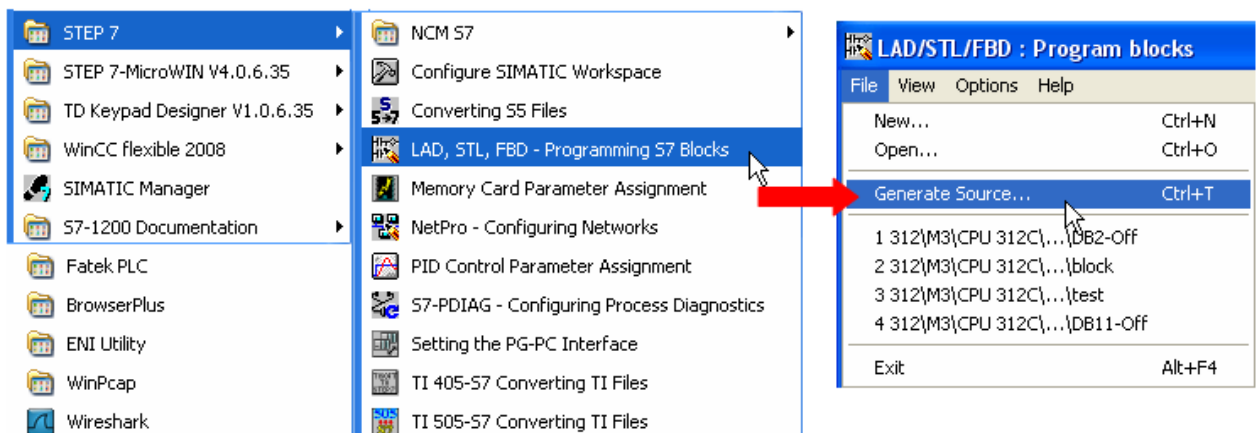


2. Building *.AWF File

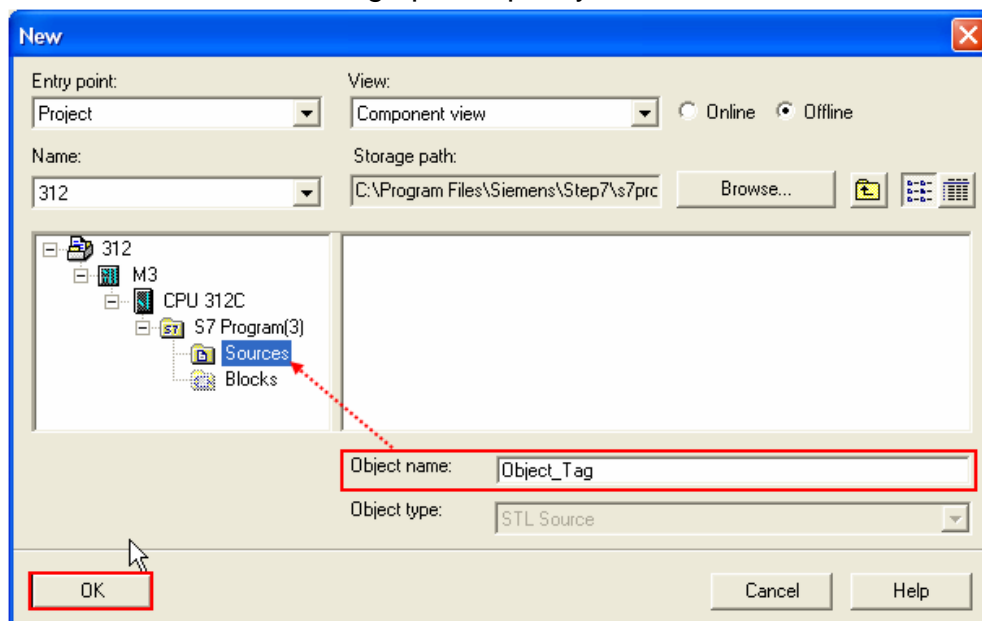
a. In **Blocks** create items as shown below:



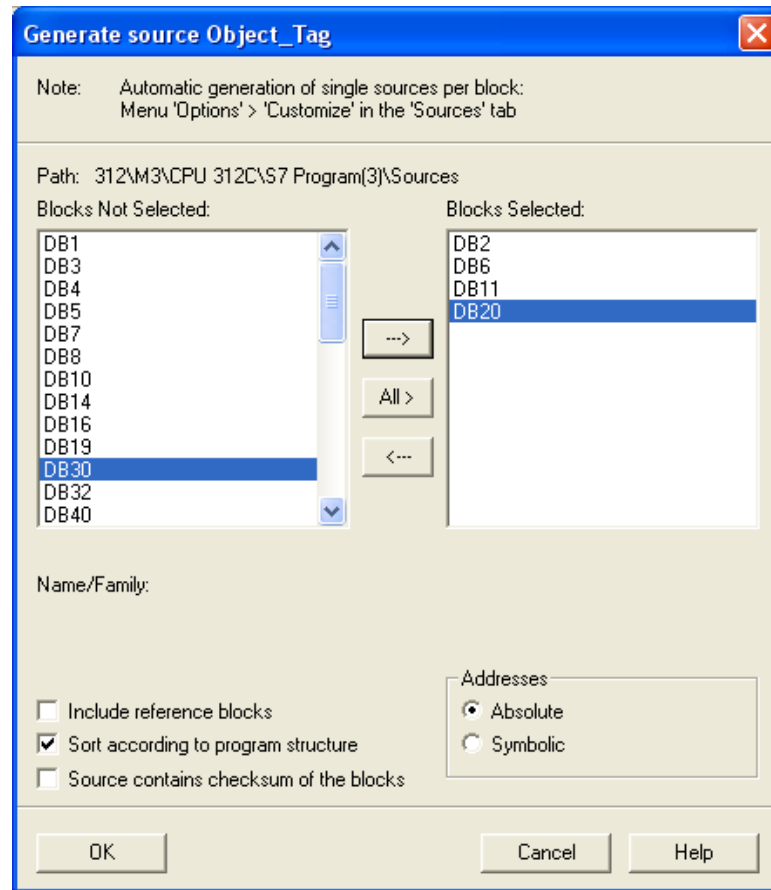
b. Open **LAD/STL, FBD – Programming S7 Blocks**, click **File -> Generate Source**.



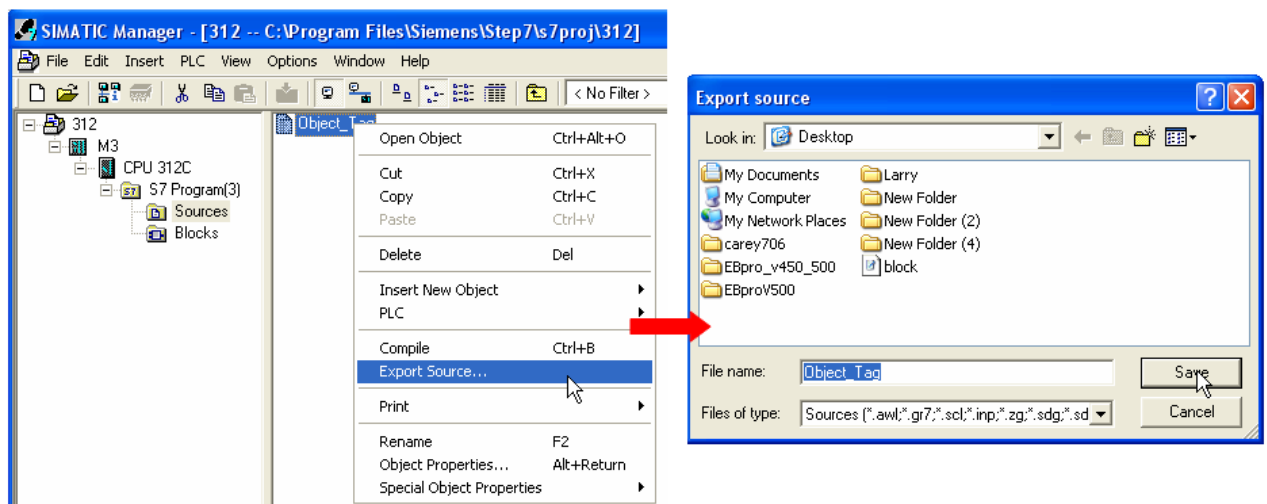
c. Select **Sources** as storage path, specify the file name then click **OK**.



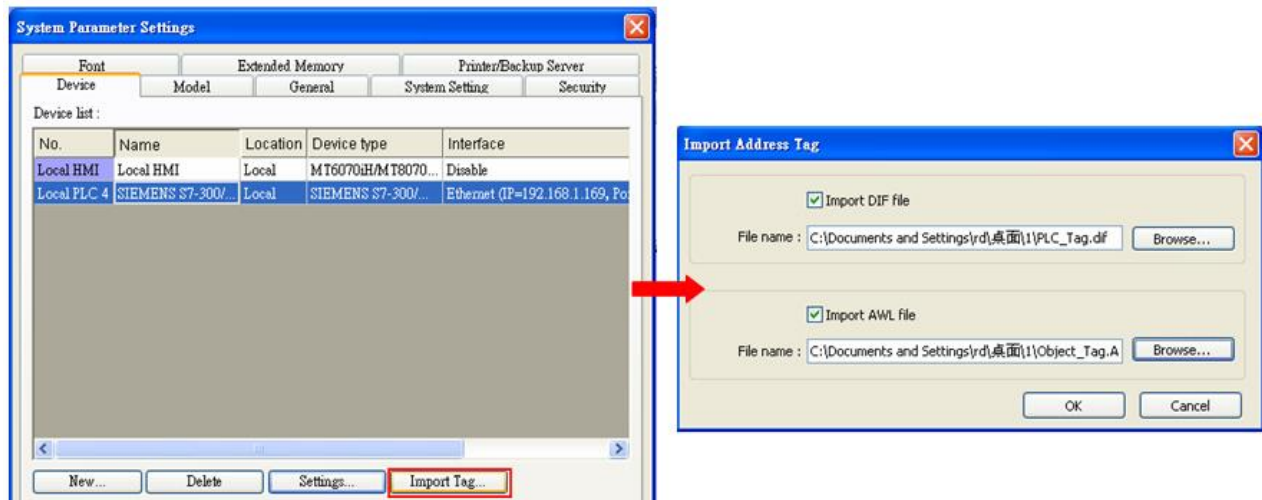
- d、 Select the objects to be exported then click **OK**.



- e、 Under **Sources** there will be names of the saved files, select **Export Source** to build *.AWL file.



The generated *.dif and *.AWL files can be imported in EasyBuilder8000/EasyBuilderPro **System Parameter Settings**, by clicking **Import Tag**.



Tag information successfully imported.



Wiring Diagram:

Ethernet cable:



Weintek Built-in CODESYS

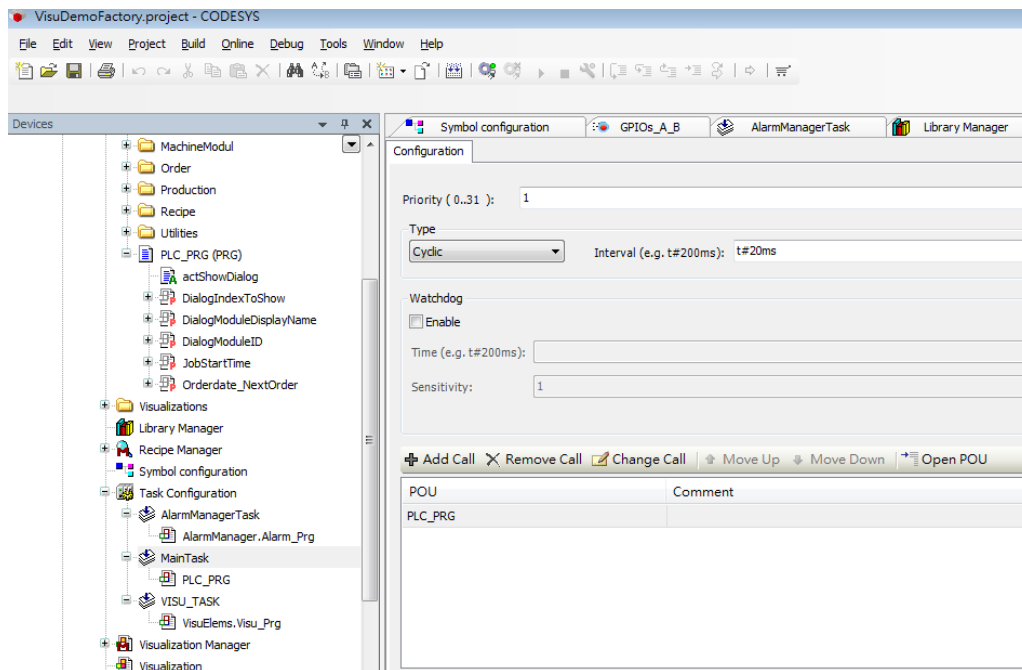
Supported series: Weintek Built-in CODESYS HMI

HMI Setting:

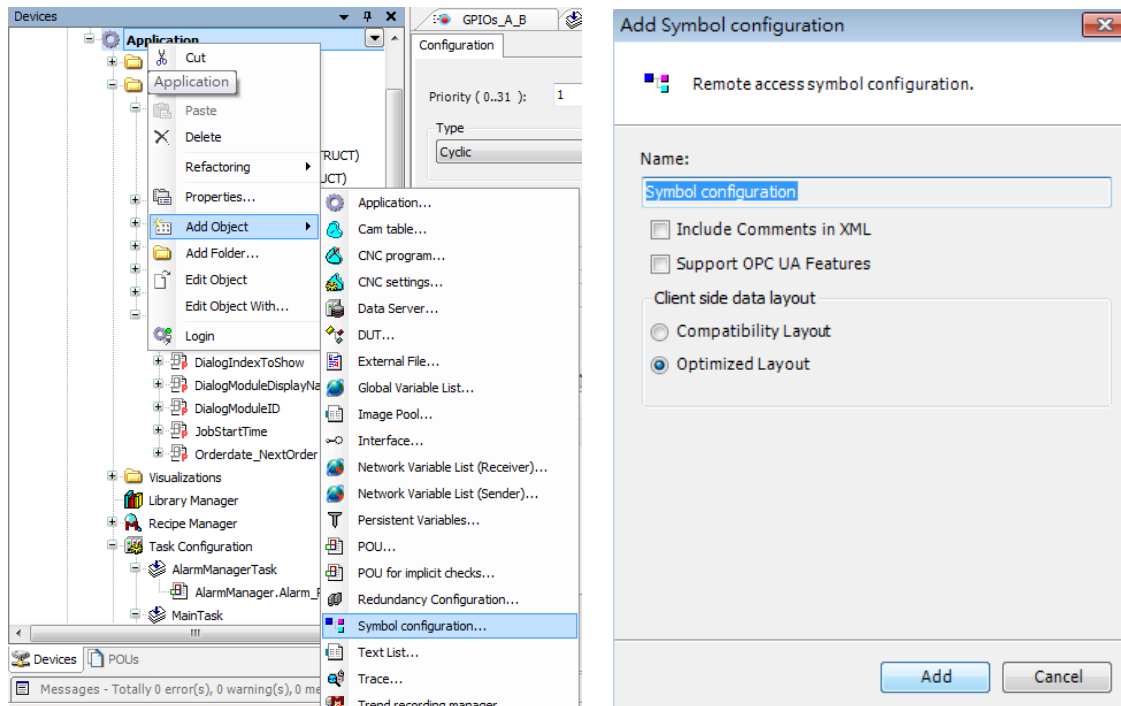
Parameters	Recommended	Options	Notes
PLC type	Weintek Built-in CODESYS		
PLC I/F	Ethernet		

How to Import Tags:

11. Under “MainTask” set POU PLC_PRG.

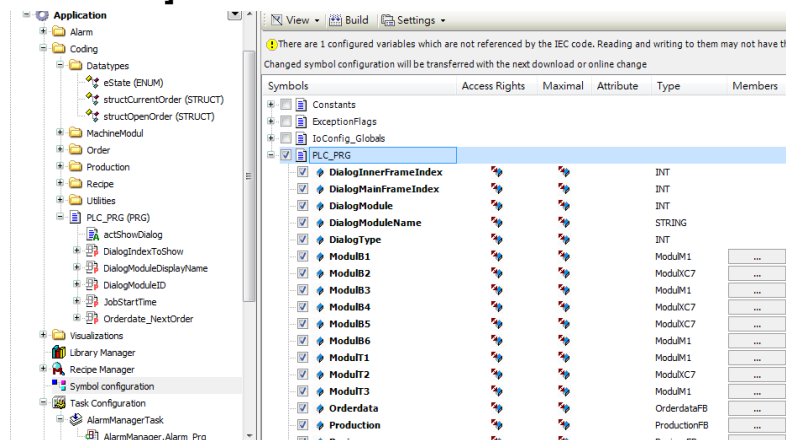


12. Add "Symbol configuration" into Devices list.



13. Select PLC_RPG and its tag information is shown, build the project.

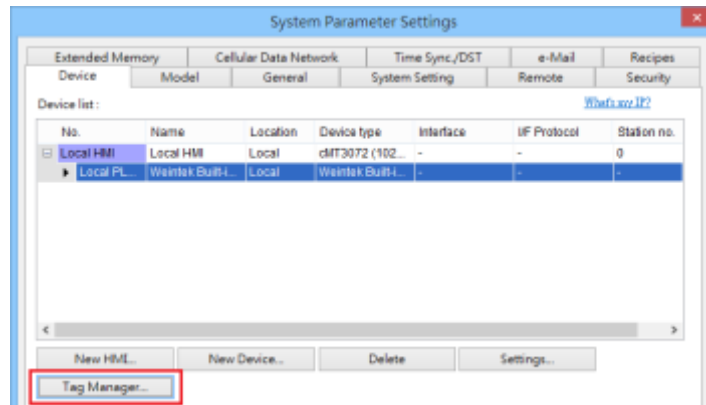
[build] -> [Generate Code]



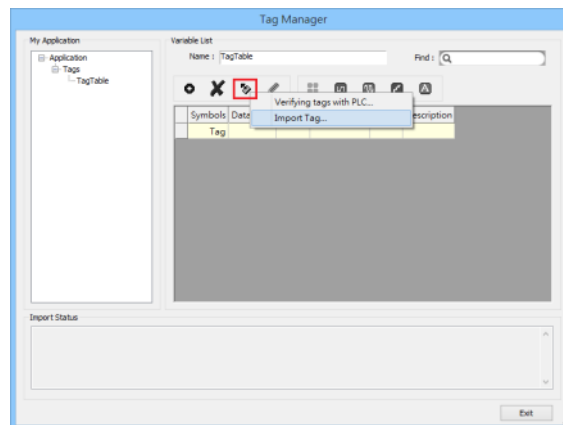
14. A *.xml file is generated in the directory of the project.

VisuDemoFactory.Device.Application.77b33013-b5cd-4...	2016/4/29 11:36	BOOTINFO 檔案	43,347 KB
VisuDemoFactory.Device.Application.77b33013-b5cd-4...	2016/4/29 11:36	BOOTINFO_GUL...	1 KB
VisuDemoFactory.Device.Application.77b33013-b5cd-4...	2016/4/29 11:36	COMPILEINFO 檔...	43,347 KB
VisuDemoFactory.Device.Application.xml	2016/4/29 11:36	XML Document	29 KB
VisuDemoFactory.project	2016/4/29 19:26	CODESYS project	1,362 KB
VisuDemoFactory.project.~u	2016/5/4 11:17	~U 檔案	1 KB
VisuDemoFactory-admin-Weintek-RD-APP1.opt	2016/4/29 19:26	OPT 檔案	81 KB
VisuDemoFactory-AllUsers.opt	2016/4/29 19:26	OPT 檔案	1 KB

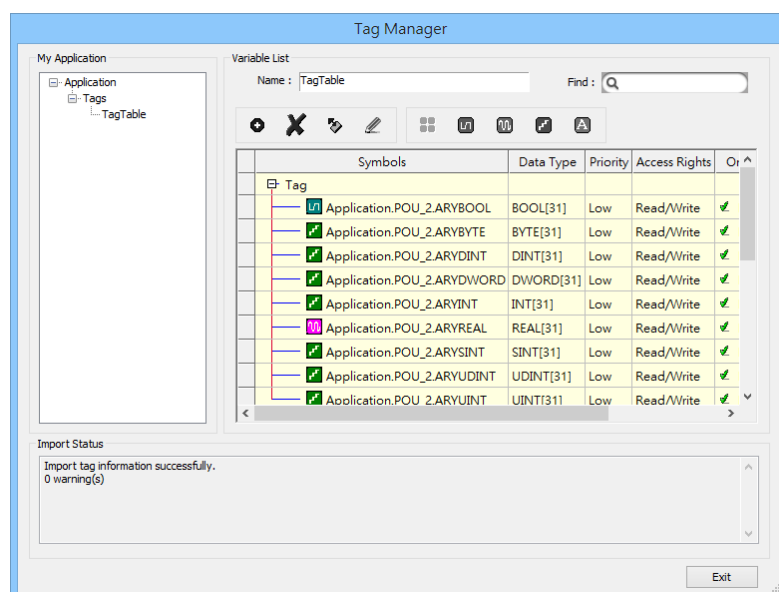
15. In System Parameter Settings click **[New]** to add Weintek Built-in CODESYS driver into the device list and then click **[Tag Manager]**.



16. In Tag Manager click **Get tag -> Import Tag**, and then select the tag file (.xml) generated by the PLC software.



17. When the tags are imported successfully, click **[Exit]** to leave.



Support Device Type:

Data type	EasyBuilder data format	Memo
Bool	bit	
Byte	16-bit BCD, Hex, Binary, Unsigned	8-bit
SInt	16-bit BCD, Hex, Binary, Signed	8-bit
USInt	16-bit BCD, Hex, Binary, Unsigned	8-bit
Word	16-bit BCD, Hex, Binary, Unsigned	16-bit
Int	16-bit BCD, Hex, Binary, Signed	16-bit
UInt	16-bit BCD, Hex, Binary, Unsigned	16-bit
DWord	32-bit BCD, Hex, Binary, Unsigned	32-bit
DInt	32-bit BCD, Hex, Binary, Signed	32-bit
Real	32-bit Float	32-bit
UDInt	32-bit BCD, Hex, Binary, Unsigned	32-bit
String	Word array for ASCII input and display	Length=word

String length must be set identical to the length in Codesys software.

Wiring Diagram:

Diagram 1

Ethernet cable:



Weintek Remote IO (CANopen)

Supported series: Weintek Remote IO (iR-COP)

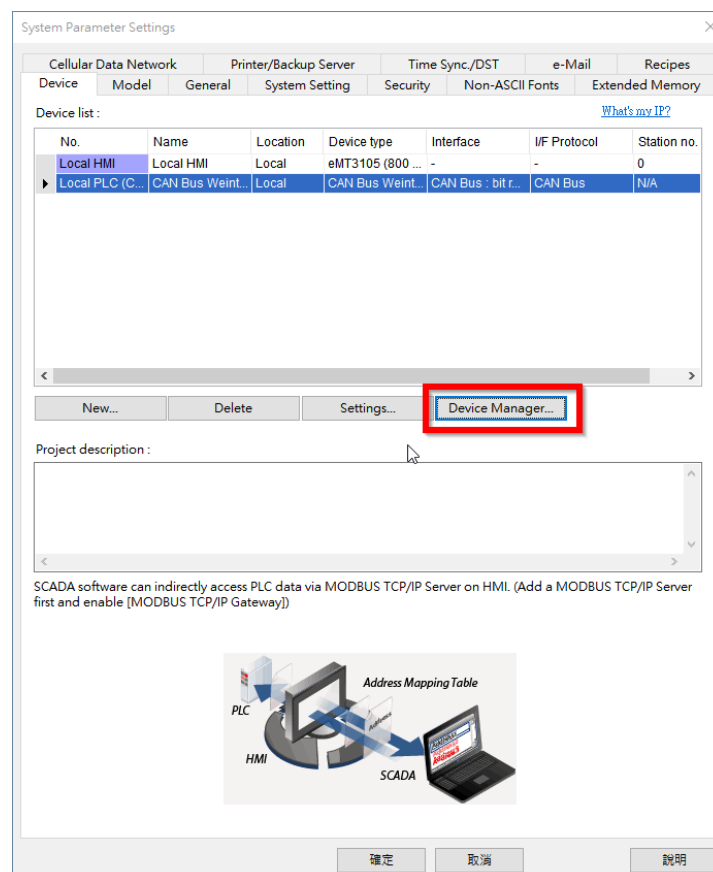
HMI Setting:

Parameters	Recommended	Options	Notes
PLC type	Weintek Remote IO (CANopen)		
Baud rate	250K	10K~1M	

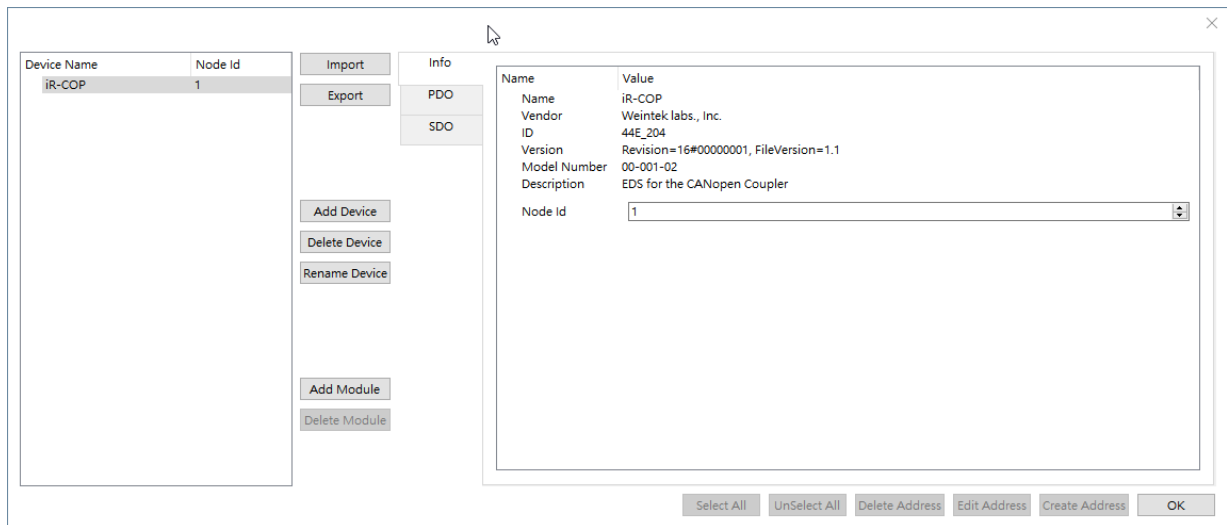
Online simulator	NO	Extend address mode	NO
-------------------------	----	----------------------------	----

Device Setting:

1. Launch EasyBuilder Pro and add **Weintek Remote I/O (CANopen)** driver into the device list, Click **[Device Manager]** to configure CANopen device and addresses.



2. In Device Manager window, a Weintek Remote I/O CANopen device can be found by default.



3. Clicking the buttons on the left side can:

Import: Import the predefined .wtco file into the device list. Please note that current device list will be overwritten by the imported list.

Export: Export current setting as a .wtco file for future use.

Add Device: Add a new Weintek Remote I/O CANopen device.

Delete Device: Delete the selected Weintek Remote I/O CANopen device.

Rename Device: Change device name.

Add Module: Weintek Remote I/O supports the following modules.

Item	Model	DeviceId	Describe	Type	Input Points	Output Points	Output Mode	Input Mode
1	iR-DI16-K	0x0154	16DI	DI	16	0	N/A	Source+Sink
2	iR-DM16-P	0x0351	8DI8DO_P	DI+DO	8	8	Source	Source+Sink
3	iR-DQ16-P	0x0251	16DO_P	DO	0	16	Source	N/A
4	iR-DM16-N	0x0352	8DI8DO_N	DI+DO	8	8	Sink	Source+Sink
5	iR-DQ16-N	0x0252	16DO_N	DO	0	16	Sink	N/A
6	iR-DM16-R	0x0353	8DI8DO_R	DI+DO	8	8	Relay	Source+Sink
7	iR-DQ16-R	0x0253	16DO_R	DO	0	16	Relay	N/A
8	iR-AI04-VI	0x0425	4AI	AI	4	0	N/A	Votage/Current
9	iR-AQ04-VI	0x0525	4AO	AO	0	4	Votage/Current	N/A
10	iR-AM06-VI	0x0635	4AI2AO	AI+AO	4	2	Votage/Current	Votage/Current
11	iR-AI04-TR	0x0426	RTDTC	RTD/TC	4	0	N/A	RTD/TC

Adding modules can show address information correctly.

Delete Module: Delete the selected module.

Tags

Info: Shows device information. Node ID can be changed within 1~127.

Info	Name	Value
PDO	Name	iR-COP
SDO	Vendor	Weintek labs., Inc.
	ID	44E_204
	Version	Revision=16#00000001, FileVersion=1.1
	Model Number	00-001-02
	Description	EDS for the CANopen Coupler
	Node Id	1

PDO (Process Data Object): This tab displays **TxPDO** and **RxPDO** Mapping for editing. Please note that changes in PDO tab will not be updated to Remote I/O. The purpose of editing PDO Mapping here is to ensure correct bit length when importing addresses to HMI, and that the displayed address names on HMI match those used in CANopen.

Info	<input type="button" value="Add Mapping"/> <input type="button" value="Edit"/> <input type="button" value="Delete"/> <input type="button" value="Move Up"/> <input type="button" value="Move Down"/>				
PDO	Name	Object	BitLength	Address	
SDO	> <input checked="" type="checkbox"/> 16#1400 1. receive PDO parameter	16#201(\$NODEID+16#1)	64	2011164	
	> <input checked="" type="checkbox"/> 16#1401 2. receive PDO parameter	16#301(\$NODEID+16#1)	64	3011164	
	> <input checked="" type="checkbox"/> 16#1402 3. receive PDO parameter	16#401(\$NODEID+16#1)	64	4011164	
	∨ <input checked="" type="checkbox"/> 16#1403 4. receive PDO parameter	16#501(\$NODEID+16#1)	64	5011164	
	<input checked="" type="checkbox"/> analog_out_16_5	16#6411:16#05	16	5011116	
	<input checked="" type="checkbox"/> analog_out_16_6	16#6411:16#06	16	5013116	
	<input checked="" type="checkbox"/> analog_out_16_7	16#6411:16#07	16	5015116	
	<input checked="" type="checkbox"/> analog_out_16_8	16#6411:16#08	16	5017116	
	<input type="checkbox"/> 16#1404 5. receive PDO parameter	16#0	0		
	<input type="checkbox"/> 16#1405 6. receive PDO parameter	16#0	0		
	<input type="checkbox"/> 16#1406 7. receive PDO parameter	16#0	0		
	<input type="checkbox"/> 16#1407 8. receive PDO parameter	16#0	0		
	> <input checked="" type="checkbox"/> 16#1800 1. transmit PDO parameter	16#181(\$NODEID+16#1)	64	1811164	
	> <input checked="" type="checkbox"/> 16#1801 2. transmit PDO parameter	16#281(\$NODEID+16#1)	64	2811164	
	> <input checked="" type="checkbox"/> 16#1802 3. transmit PDO parameter	16#381(\$NODEID+16#1)	64	3811164	
	> <input checked="" type="checkbox"/> 16#1803 4. transmit PDO parameter	16#481(\$NODEID+16#1)	64	4811164	
	<input type="checkbox"/> 16#1804 5. transmit PDO parameter	16#0	0		
	<input type="checkbox"/> 16#1805 6. transmit PDO parameter	16#0	0		
	<input type="checkbox"/> 16#1806 7. transmit PDO parameter	16#0	0		
	<input type="checkbox"/> 16#1807 8. transmit PDO parameter	16#0	0		

The five buttons at the top of the PDO tab can:

- **Add Mapping:** When the PDO object's bit length is less than 64, the user can add PDO Mapping into the list.

Name	Object	BitLength	Address
<input checked="" type="checkbox"/> 16#1400 1. receive PDO parameter	16#201(\$NODEID+16#1)	64	2011164
<input checked="" type="checkbox"/> 16#1401 2. receive PDO parameter	16#301(\$NODEID+16#1)	56	3011164
<input checked="" type="checkbox"/> Ouput8 40H-47H	16#6200:16#09	8	3011108
<input checked="" type="checkbox"/> Ouput8 48H-4FH	16#6200:16#0A	8	3012108
<input checked="" type="checkbox"/> Ouput8 50H-57H	16#6200:16#0B	8	3013108
<input checked="" type="checkbox"/> Ouput8 58H-5FH	16#6200:16#0C	8	3014108
<input checked="" type="checkbox"/> Ouput8 60H-67H	16#6200:16#0D	8	3015108
<input checked="" type="checkbox"/> Ouput8 68H-6FH	16#6200:16#0E	8	3016108
<input checked="" type="checkbox"/> Ouput8 70H-77H	16#6200:16#0F	8	3017108
<input checked="" type="checkbox"/> 16#1402 3. receive PDO parameter	16#401(\$NODEID+16#1)	64	4011164
<input checked="" type="checkbox"/> analog_out_16_1	16#6411:16#01	16	4011116
<input checked="" type="checkbox"/> analog_out_16_2	16#6411:16#02	16	4013116
<input checked="" type="checkbox"/> analog_out_16_3	16#6411:16#03	16	4015116
<input checked="" type="checkbox"/> analog_out_16_4	16#6411:16#04	16	4017116
<input checked="" type="checkbox"/> 16#1403 4. receive PDO parameter	16#501(\$NODEID+16#1)	64	5011164
<input checked="" type="checkbox"/> analog_out_16_5	16#6411:16#05	16	5011116
<input checked="" type="checkbox"/> analog_out_16_6	16#6411:16#06	16	5013116
<input checked="" type="checkbox"/> analog_out_16_7	16#6411:16#07	16	5015116
<input checked="" type="checkbox"/> analog_out_16_8	16#6411:16#08	16	5017116
<input type="checkbox"/> 16#1404 5. receive PDO parameter	16#0	0	
<input type="checkbox"/> 16#1405 6. receive PDO parameter	16#0	0	

Select source of Mapping Object.

Index:Subindex	Name	Access Type	Type	Default
16#6200	write digital output 8-bit			
:16#01	Ouput8 0H-7H	RWW	USI...	16#0
:16#02	Ouput8 8H-7FH	RWW	USI...	16#0
:16#03	Ouput8 10H-17H	RWW	USI...	16#0
:16#04	Ouput8 18H-1FH	RWW	USI...	16#0
:16#05	Ouput8 20H-27H	RWW	USI...	16#0
:16#06	Ouput8 28H-2FH	RWW	USI...	16#0
:16#07	Ouput8 30H-37H	RWW	USI...	16#0
:16#08	Ouput8 38H-3FH	RWW	USI...	16#0
:16#09	Ouput8 40H-47H	RWW	USI...	16#0
:16#0A	Ouput8 48H-4FH	RWW	USI...	16#0
:16#0B	Ouput8 50H-57H	RWW	USI...	16#0
:16#0C	Ouput8 58H-5FH	RWW	USI...	16#0
:16#0D	Ouput8 60H-67H	RWW	USI...	16#0
:16#0E	Ouput8 68H-6FH	RWW	USI...	16#0
:16#0F	Ouput8 70H-77H	RWW	USI...	16#0
:16#10	Ouput8 78H-7FH	RWW	USI...	16#0
:16#11	Ouput8 80H-87H	RWW	USI...	16#0
:16#12	Ouput8 88H-8FH	RWW	USI...	16#0
:16#13	Ouput8 90H-97H	RWW	USI...	16#0

Name: Ouput8 20H-27H

Index: 16#6200 BitLength: 8

Subindex: 16#5

OK Cancel

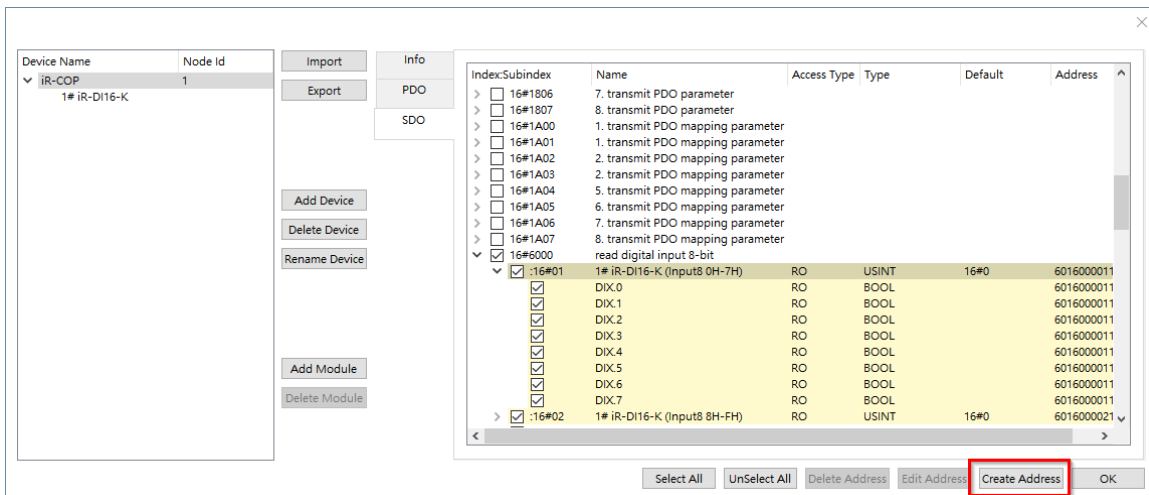
- **Edit:** Change the source of the selected Mapping Object.
- **Delete:** Delete the selected Mapping Object.
- **Move Up:** Move the selected Mapping Object one row upward.
- **Move Down:** Move the selected Mapping Object one row downward.

SDO (Service Data Object): Displays all items in Object Dictionary.

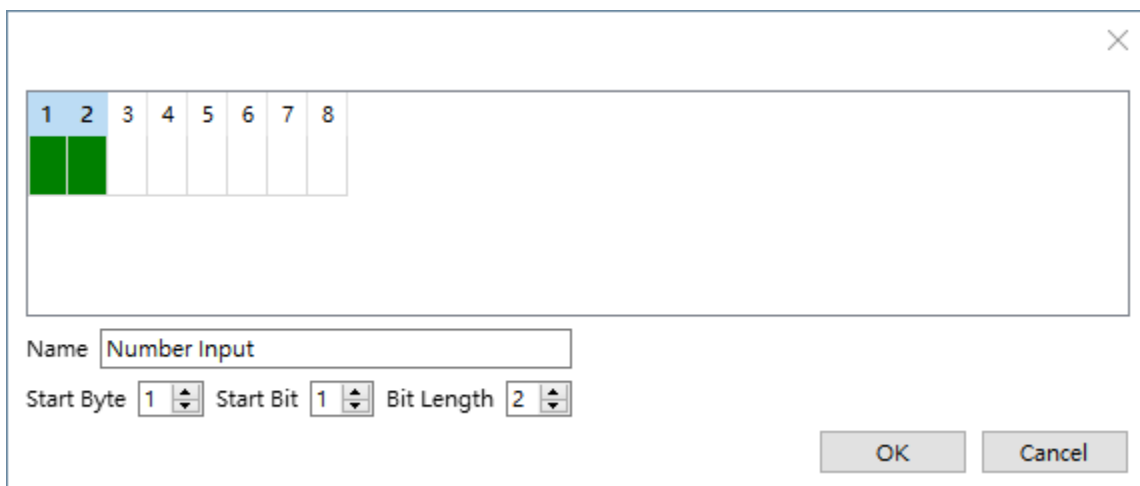
Selecting and Defining Addresses

Users can define address range of the existing items.

For example, to add a user-defined address range under item **[6000] read digital input 8-bit #01** in SDO tab, select the item in the index tree and then click **[Create Address]**.



A dialog box pops up for defining address range. Using the same settings below will add a **Number Input** tag under item **[6000] read digital input 8-bit #01**. The tag will use bit 1~2 of the item as its value. That is, if the value in the item is 15, the value in the tag will be 3.



The buttons at the bottom of both SDO and PDO tab can:

- **Select All:** Select all items.
- **Unselect All:** Unselect all items.
- **Delete Address:** Delete user-defined address.
- **Edit Address:** Edit user-defined address.
- **Create Address:** Create user-defined address.
- **OK:** Import addresses.

Info

PDO

SDO

Index/Subindex	Name	Access Type	Type	Default	Address
> <input type="checkbox"/> 16#1803	4. transmit PDO parameter				
> <input type="checkbox"/> 16#1804	5. transmit PDO parameter				
> <input type="checkbox"/> 16#1805	6. transmit PDO parameter				
> <input type="checkbox"/> 16#1806	7. transmit PDO parameter				
> <input type="checkbox"/> 16#1807	8. transmit PDO parameter				
> <input type="checkbox"/> 16#1A00	1. transmit PDO mapping parameter				
> <input type="checkbox"/> 16#1A01	1. transmit PDO mapping parameter				
> <input type="checkbox"/> 16#1A02	2. transmit PDO mapping parameter				
> <input type="checkbox"/> 16#1A03	2. transmit PDO mapping parameter				
> <input type="checkbox"/> 16#1A04	5. transmit PDO mapping parameter				
> <input type="checkbox"/> 16#1A05	6. transmit PDO mapping parameter				
> <input type="checkbox"/> 16#1A06	7. transmit PDO mapping parameter				
> <input type="checkbox"/> 16#1A07	8. transmit PDO mapping parameter				
▼ <input checked="" type="checkbox"/> 16#6000	read digital input 8-bit				
> <input checked="" type="checkbox"/> :16#01	1# iR-DI16-K (Input8 0H-7H)	RO	USINT	16#0	6016000011
> <input checked="" type="checkbox"/> :16#02	1# iR-DI16-K (Input8 8H-FH)	RO	USINT	16#0	6016000021
> <input type="checkbox"/> :16#03	Input8 10H-17H	RO	USINT	16#0	6016000031
> <input type="checkbox"/> :16#04	Input8 18H-1FH	RO	USINT	16#0	6016000041
> <input type="checkbox"/> :16#05	Input8 20H-27H	RO	USINT	16#0	6016000051
> <input type="checkbox"/> :16#06	Input8 28H-2FH	RO	USINT	16#0	6016000061
> <input type="checkbox"/> :16#07	Input8 30H-37H	RO	USINT	16#0	6016000071

Select All
UnSelect All
Delete Address
Edit Address
Create Address
OK

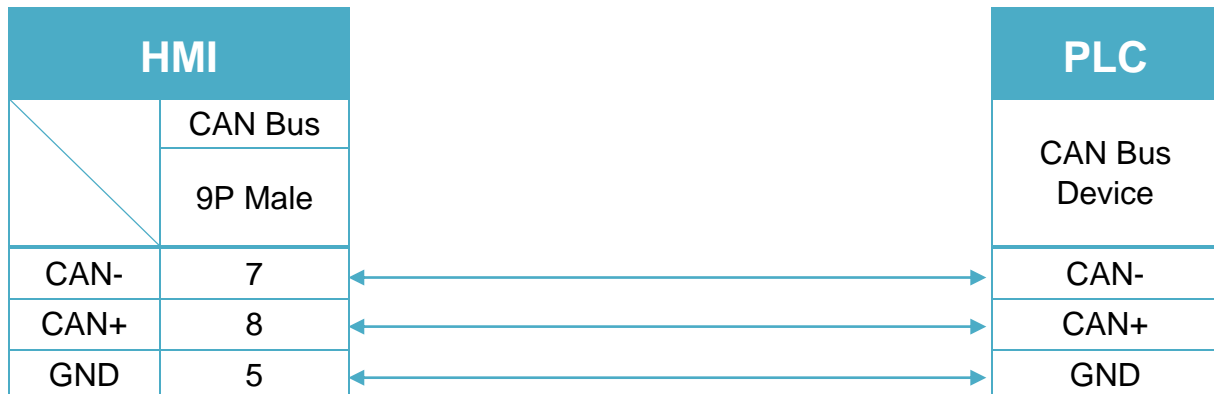
Device Address:

Bit/Word	Device type	Format	Range	Memo
W	SDO_DATA	HHHHIISS BbNN	1101~FFFF FFFFFF8801	H: Can ID I: Index S: SubIndex B: Byte position (1~8) b: bit start position (1~8) NN: bit no. (1~64)
W	PDO_DATA	HHHHHH HHBbNN	1101~1FFF FFFF8801	H: Can ID B: Byte position (1~8) b: bit start position (1~8) NN: bit no. (1~64)
B	PDO_DATA_Bit	HHHHHH HHBb	11~1FFFFF FF88	H: Can ID B: Byte position (1~8) b: bit start position (1~8)
B	SDO_DATA_Bit	HHHHIISS Bb	11~FFFFFF FFF88	H: Can ID I: Index S: SubIndex B: Byte position (1~8) b: bit start position (1~8)

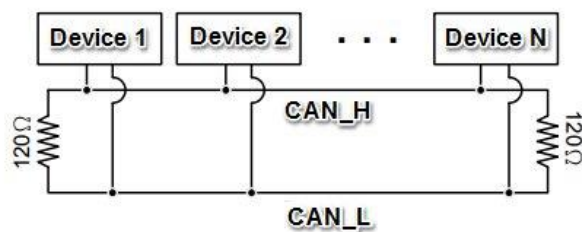
Wiring Diagram:

Diagram 1

cMT Series	cMT-3151
eMT Series	eMT3070 / eMT3105 / eMT3120 / eMT3150
MT-XE	MT8092XE



To minimize signal reflection on the CAN bus network, termination resistors should be installed at both ends of the network, as shown in the following figure. (eMT3070A has built-in termination resistor, so it is not required for eMT3070A)



Weintek Remote IO (MODBUS TCP/IP)

Supported Series: Weintek Remote IO (iR-ETN)

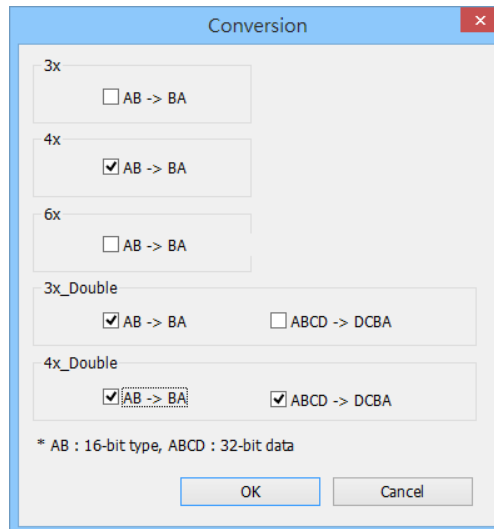
HMI Setting:

Parameters	Recommended	Options	Notes
PLC type	Weintek Remote IO (MODBUS TCP/IP)		
PLC I/F	Ethernet		
Port no.	502		
PLC sta. no.	1	0~255	

Device Address:

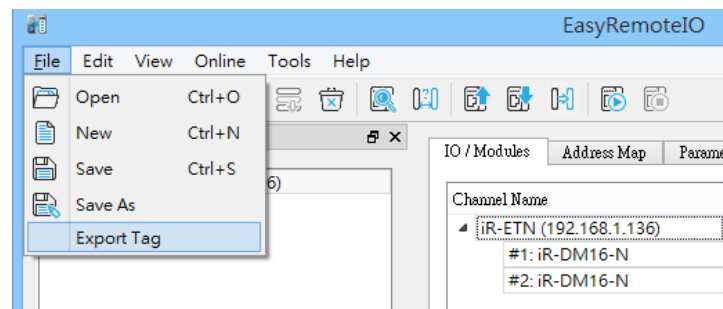
Bit/Word	Device type	Format	Range	Memo
B	0x	DDDDD	0 ~ 65535	Output bit
B	0x_single_Bit	DDDDD	0 ~ 65535	
B	0x_multi_coils	DDDDD	0 ~ 65535	Write multiple coils
B	1x	DDDDD	0 ~ 65535	Input bit (read only)
B	1x_single_Bit	DDDDD	0 ~ 65535	
B	3x_bit	DDDDDdd	0 ~ 6553515	Input Register bit(read
B	4x_bit	DDDDDdd	0 ~ 6553515	Output Register bit
B	6x_bit	DDDDDdd	0 ~ 6553515	Output Register bit
W	3x	DDDDD	0 ~ 65535	Input Register
DW	3x_Double	DDDDD	0 ~ 65535	*Note1
W	4x	DDDDD	0 ~ 65535	Output Register
DW	4X_Double	DDDDD	0 ~ 65535	*Note1
DW	5x	DDDDD	0 ~ 65535	4x double word swap
W	6x	DDDDD	0 ~ 65535	4x single word write
W	4x string central europe	DDDDD	0 ~ 65535	Convert the Central Europe ASCII to Unicode.
W	4x string central europe (rev)	DDDDD	0 ~ 655355	

Note1: Go the [System Parameter Settings] -> [Device Properties] and click [Conversion] to set the data format of device types 3x, 4x, 6x, 3x_double, 4x double.

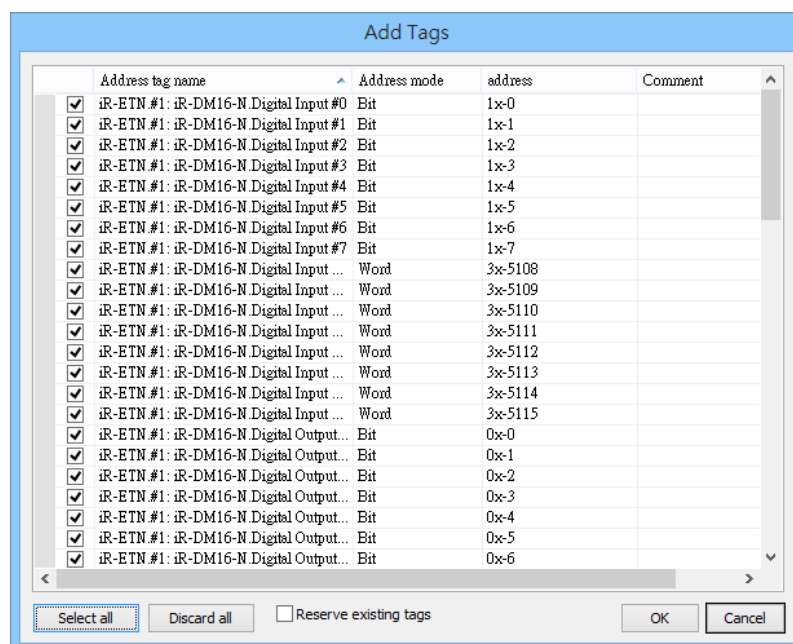


How to Import Tags:

Step1. EasyRemoteIO export tag



Step2. EasyBuilder Pro -> System Parameter Settings -> Device (Driver) -> Import Tags



Wiring Diagram:

Diagram 1

Ethernet cable:



WIELAND SAMOS PRO

Supported Series: Samos Pro controllers SP-SCON-P1-K, SP-SCON-NET-PA-K

Website: <http://www.wieland-electric.com/en/products/safety-technology>

HMI Setting:

Parameters	Recommended	Options	Notes
PLC type	WIELAND SAMOS PRO		
PLC I/F	RS232		
Baud rate	115200	9600,19200,38400,57600,115200	
Data bits	8		
Parity	None		
Stop bits	1		
PLC sta. no.	0		

Device Address:

Bit/Word	Device type	Format	Range	Memo
B	I	DDo	0 ~ 967	Input
B	Q	DDo	0 ~ 487	Output
B	Logic result	DDo	0 ~ 327	Logic Result
B	RS-232	DDo	0 ~ 327	RS-232
B	Samos Pro to RS-232_Bit	DDo	0 ~ 997	
B	Module Status Bit Array_Bit	DDo	0 ~ 597	
B	Operating Data Block_Bit	Do	0 ~ 97	
B	Configuration CRCs_Bit	DDo	0 ~ 197	
B	CPU Module Type Key_Bit	DDo	0 ~ 177	
B	Extension Modules Type_Bit	DDD	0 ~ 3377	
W	RS-232 to Samos Pro	D	0 ~ 2	
W	Samos Pro to RS-232	DD	0 ~ 98	
W	Module Status Bit Array	DD	0 ~ 58	
W	Operating Data Block	D	0 ~ 8	
W	Configuration CRCs	DD	0 ~ 18	
W	CPU Module Type Key	DD	0 ~ 16	
W	Extension Modules Type	DDD	0 ~ 336	

Wiring Diagram:

The following is the view from the soldering point of a connector.



CPU0 Port0 4P Mini-DIN (Diagram1~ Diagram3)

Diagram 1

cMT Series	<i>cMT3151</i>
eMT Series	<i>eMT3070 / eMT3105 / eMT3120 / eMT3150</i>
MT-iE	<i>MT8073iE / MT8102iE</i>
MT-XE	<i>MT8092XE</i>
MT-iP	<i>MT6103iP</i>

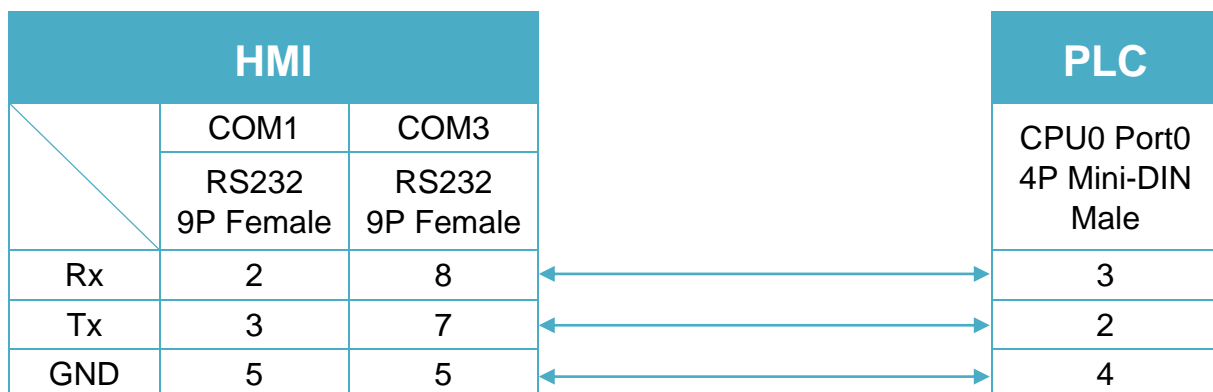


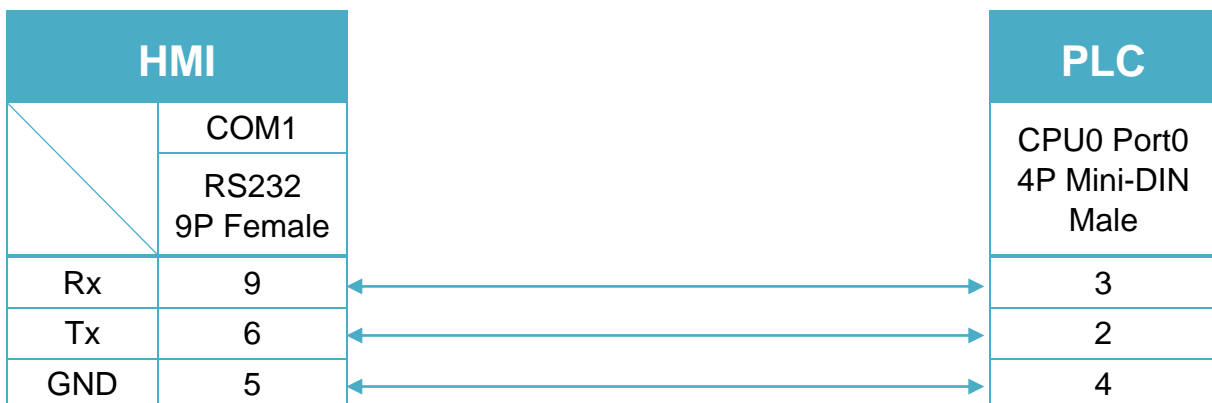
Diagram 2

cMT Series	cMT-SVR
mTV	mTV
MT-iE	MT8070iE / MT6070iE / MT8100iE / MT8121iE / MT8150iE / MT8071iE / MT6071iE / MT8072iE / MT6072iE / MT8073iE / MT8101iE / MT8102iE / MT8103iE
MT-XE	MT8121XE / MT8150XE / MT8090XE



Diagram 3

MT-iE	MT8050iE
MT-iP	MT6051iP / MT6071iP / MT8071iP



XINJE XC Series

Supported Series: XINJE XC Series

Website: <http://www.xinje.com>

HMI Setting:

Parameters	Recommended	Options	Notes
PLC type	XINJE XC Series		
PLC I/F	RS232	RS232	
Baud rate	19200		
Data bits	8		
Parity	Even		
Stop bits	1		
PLC sta. no.	1	0-255	

*Support communications between HMI and PLC in pass-through mode

*Set LW-9903 to 2 to enhance the speed of download/upload PLC program in pass-through mode

Device Address:

Bit/Word	Device type	Format	Range	Memo
B	M	DDDD	0 ~ 8511	
B	X	OOOO	0 ~ 1037	
B	Y	OOOO	0 ~ 1037	
B	S	DDDD	0 ~ 1023	
B	T	DDD	0 ~ 618	
B	C	DDD	0 ~ 634	
W	D	DDDD	0 ~ 8511	
W	TD	DDD	0 ~ 618	
W	CD	DDD	0 ~ 634	
W	FD_1	DDDD	0 ~ 5000	
W	FD_2	DDDD	8000 ~ 8511	

Wiring Diagram:

The following is the view from the soldering point of a connector.



RS-232 8P Mini-DIN (Diagram1~ Diagram3)

Diagram 1

cMT Series	<i>cMT3151</i>
eMT Series	<i>eMT3070 / eMT3105 / eMT3120 / eMT3150</i>
MT-iE	<i>MT8073iE / MT8102iE</i>
MT-XE	<i>MT8092XE</i>
MT-iP	<i>MT6103iP</i>

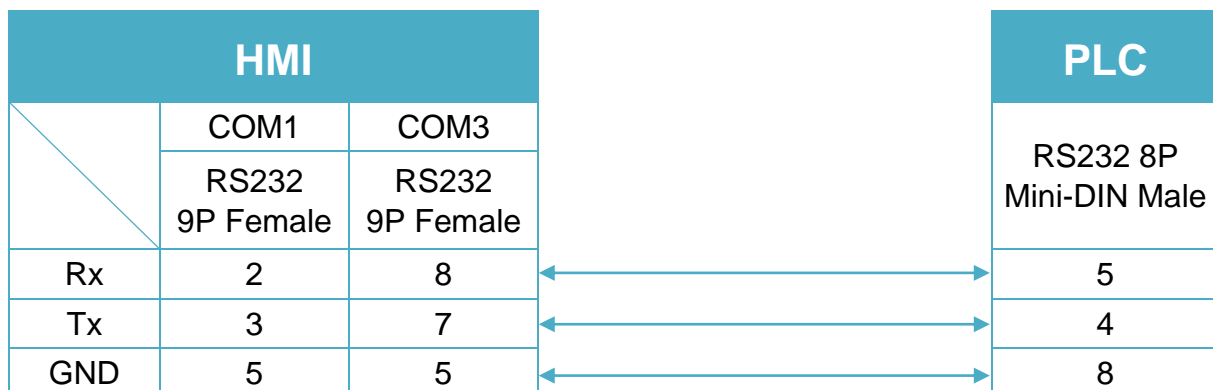


Diagram 2

cMT Series	cMT-SVR
mTV	mTV
MT-iE	MT8070iE / MT6070iE / MT8100iE / MT8121iE / MT8150iE / MT8071iE / MT6071iE / MT8072iE / MT6072iE / MT8073iE / MT8101iE / MT8102iE / MT8103iE
MT-XE	MT8121XE / MT8150XE / MT8090XE

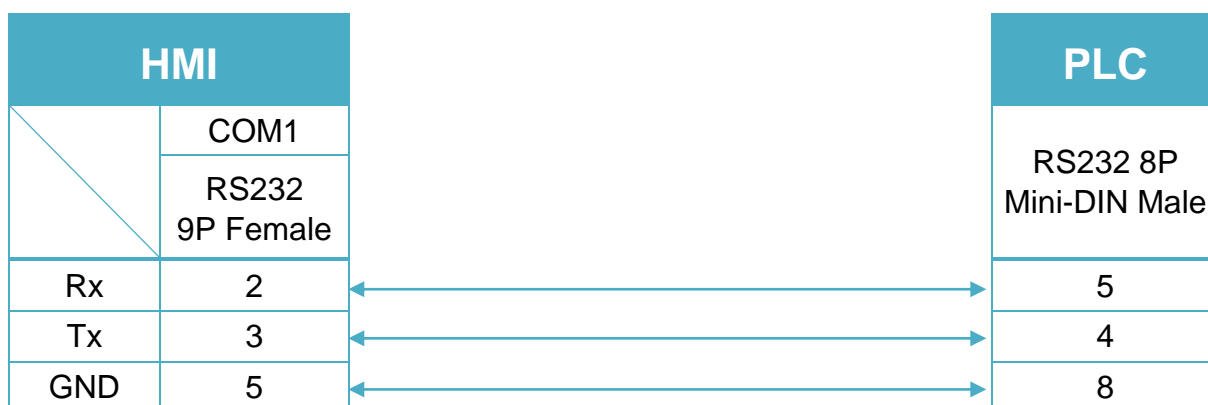
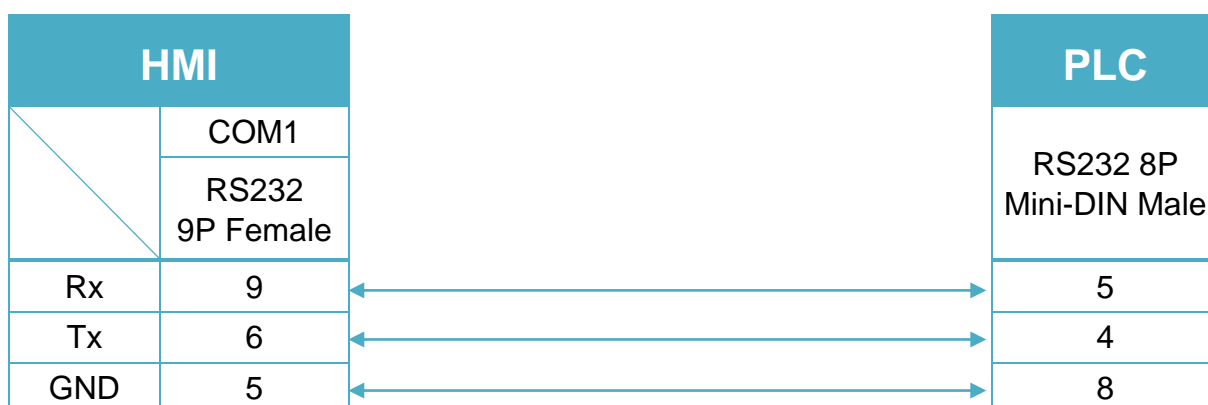


Diagram 3

MT-iE	MT8050iE
MT-iP	MT6051iP / MT6071iP / MT8071iP



XINJE XD Series

Supported Series: XINJE XD Series

Website: <http://www.xinje.com>

HMI Setting:

Parameters	Recommended	Options	Notes
PLC type	XINJE XD Series		
PLC I/F	RS232		
Baud rate	19200		
Data bits	8		
Parity	Even		
Stop bits	1		
PLC sta. no.	1	0-255	

Device Address:

Bit/Word	Device type	Format	Range	Memo
B	M	DDDDD	0 ~ 20479	
B	X	OO	0 ~ 77	
B	Y	OO	0 ~ 77	
B	S	DDDD	0 ~ 7999	
B	SM	DDDD	0 ~ 4095	
B	T	DDDD	0 ~ 4095	
B	C	DDDD	0 ~ 4095	
B	ET	DD	0 ~ 39	
B	SEM	DDD	0 ~ 127	
B	HM	DDDD	0 ~ 6143	
B	HS	DDD	0 ~ 999	
B	HT	DDDD	0 ~ 1023	
B	HC	DDDD	0 ~ 1023	
B	HSC	DD	0 ~ 39	
B	X_Extension	OOOOO	10000 ~ 11777	
B	X_BD	OOOOO	20000 ~ 20100	
B	Y_Extension	OOOOO	10000 ~ 11777	
B	Y_BD	OOOOO	20000 ~ 20100	
W	D	DDDDD	0 ~ 20479	

Bit/Word	Device type	Format	Range	Memo
W	ID	DD	0 ~ 99	
W	QD	DD	0 ~ 99	
W	SD	DDDD	0 ~ 4095	
W	TD	DDDD	0 ~ 4095	
W	CD	DDDD	0 ~ 4095	
W	ETD	DD	0 ~ 39	
W	HD	DDDD	0 ~ 6143	
W	HSD	DDDD	0 ~ 1023	
W	HTD	DDDD	0 ~ 1023	
W	HCD	DDDD	0 ~ 1023	
W	HSCD	DD	0 ~ 39	
W	FD	DDDD	0 ~ 8191	
W	SFD	DDDD	0 ~ 5999	
W	FS	DD	0 ~ 47	
W	ID_Extension	DDDDD	10000 ~ 11599	
W	ID_BD	DDDDD	20000 ~ 20099	
W	QD_Extension	DDDDD	10000 ~ 11599	
W	QD_BD	DDDDD	20000 ~ 20099	

Wiring Diagram:

The following is the view from the soldering point of a connector.



RS-232 8P Mini-DIN (Diagram1~ Diagram3)

Diagram 1

cMT Series	<i>cMT3151</i>
eMT Series	<i>eMT3070 / eMT3105 / eMT3120 / eMT3150</i>
MT-iE	<i>MT8073iE / MT8102iE</i>
MT-XE	<i>MT8092XE</i>
MT-iP	<i>MT6103iP</i>

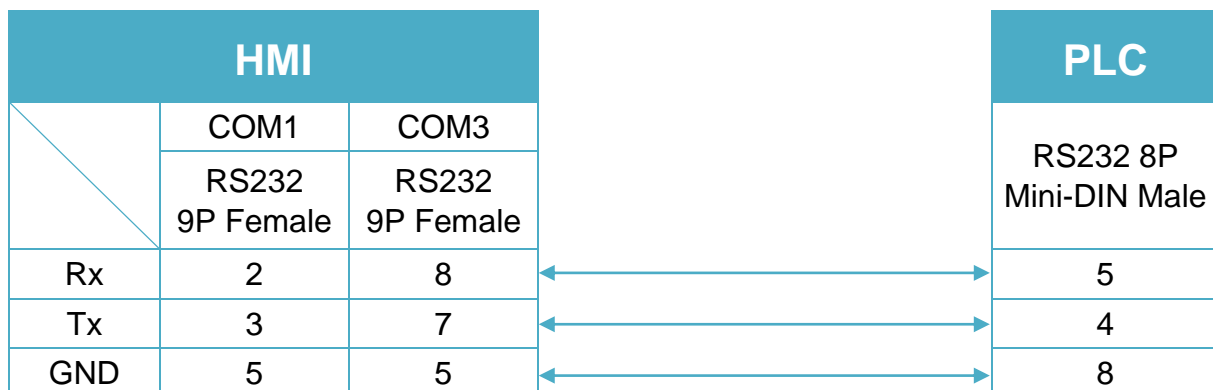


Diagram 2

cMT Series	cMT-SVR
mTV	mTV
MT-iE	MT8070iE / MT6070iE / MT8100iE / MT8121iE / MT8150iE / MT8071iE / MT6071iE / MT8072iE / MT6072iE / MT8073iE / MT8101iE / MT8102iE / MT8103iE
MT-XE	MT8121XE / MT8150XE / MT8090XE

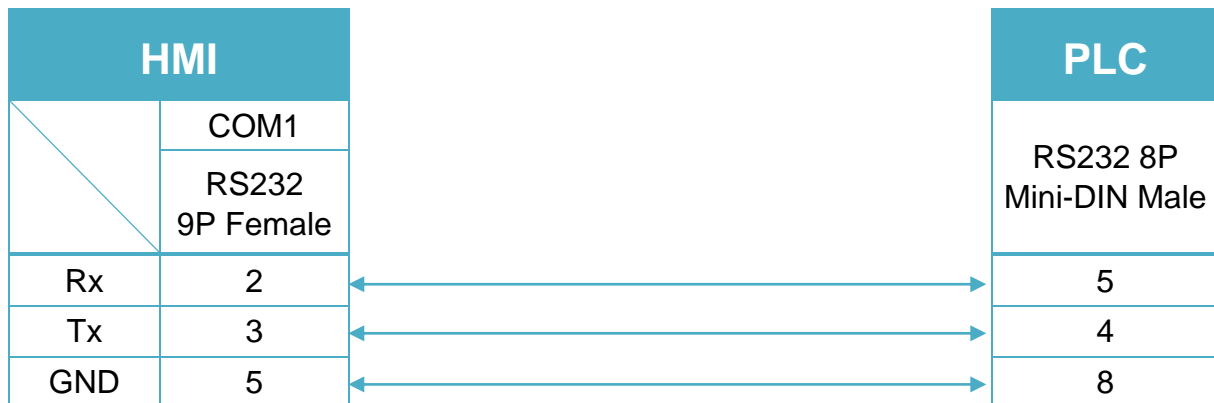
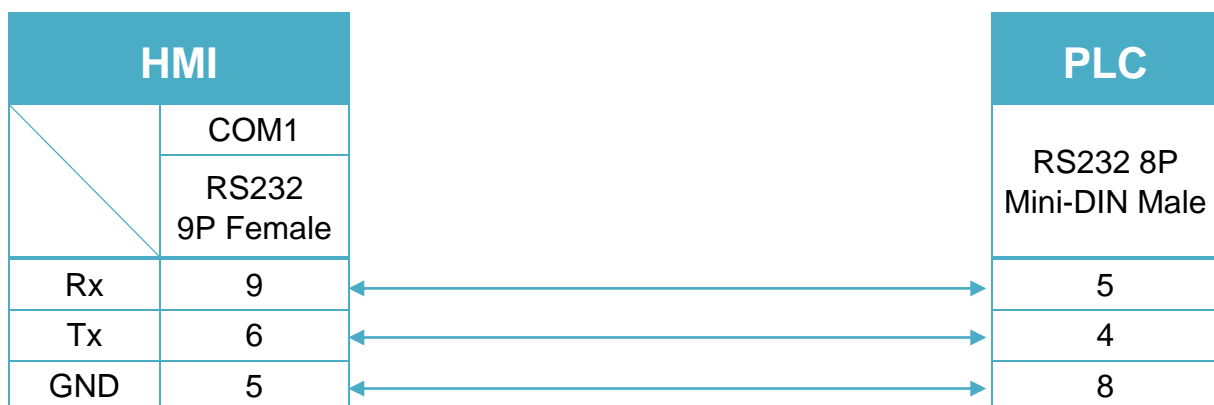


Diagram 3

MT-iE	MT8050iE
MT-iP	MT6051iP / MT6071iP / MT8071iP



YAMAHA ERCD

HMI Setting:

Parameters	Recommended	Options	Notes
PLC type	YAMAHA ERCD		
PLC I/F	RS232		
Baud rate	9600	1200-19200	
Data bits	8	7 or 8	
Parity	Odd	None/Even/Odd	
Stop bits	1	1 or 2	
PLC sta. no.	0		Needn't to set the station No.

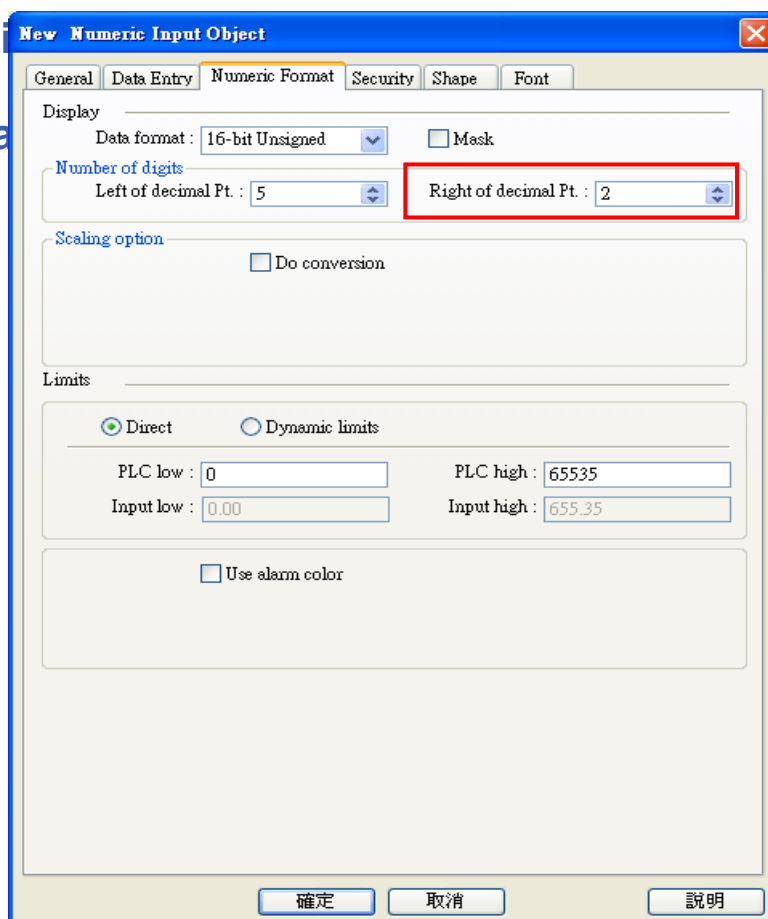
Device Address:

Bit/Word	Device type	Format	Range	Memo
Bit	DI	DD	0 ~ 15	Sequence Input (Read only)
Bit	DO	D	0 ~ 7	Sequence Output (Read only)
Bit	EMG	D	0	Emergency stop status (Read only)
Bit	SRVO	D	0	Servo Status (Read/Write)
Bit	ORG_Sensor	D	0	Original sensor status (Read only)
Bit	RESET	D	0	Set on to reset program (Write only)
Bit	RUN	D	0	Set on to execute a program (Write only)
Bit	X_ADD	D	0	Set on to move robot to + side (Write only)
Bit	X_SUB	D	0	Set on to move robot to - side (Write only)
Word	P	DDD	0 ~ 999	PNT point data (Read/Write) *Note
Word	PRM	DD	0 ~ 99	Parameters (Read/Write)
Word	SWI	D	0	Switches program number to run RW0=program number (Write only) Set the parameter of RW register, and then enter any value in this register.
Word	MOVD	D	0	Directly moves to specified position RW1=X-axis position(mm), RW2=speed (Write only) Set the parameter of RW register, and then enter any value in this register.
Word	ORG	D	0	Return to original activity (Enter any value) ,

Bit/Word	Device type	Format	Range	Memo
				Return to original status (Read/Write)
Word	MODE	D	0	動作模式
Word	POS	D	0	Current position (Read only) *Note
Word	NO	D	0	Current program number (Read only)
Word	SNO	D	0	Current step number (Read only)
Word	TNO	D	0	Current task number (Read only)
Word	PNO	D	0	Current selected point number (Read only)



The value read in address types P and POS is timed by 100, therefore, the value is rounded to the second place.



Wiring Diagram:

RS-232 9P D-Sub (Diagram 1 ~ Diagram3)

Diagram 1

cMT Series	<i>cMT3151</i>
eMT Series	<i>eMT3070 / eMT3105 / eMT3120 / eMT3150</i>
MT-iE	<i>MT8073iE / MT8102iE</i>
MT-XE	<i>MT8092XE</i>
MT-iP	<i>MT6103iP</i>

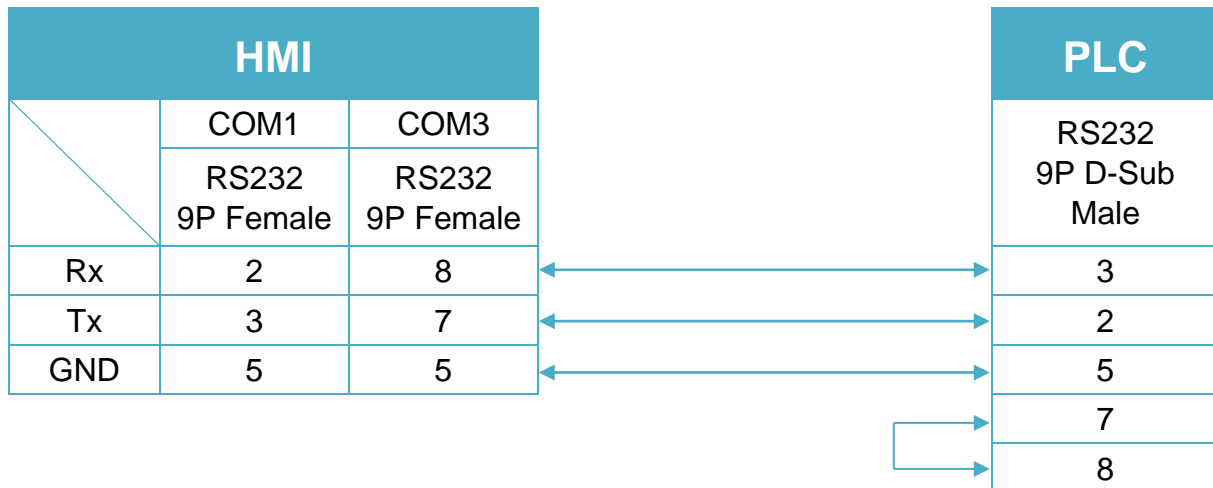


Diagram 2

cMT Series	cMT-SVR
mTV	mTV
MT-iE	MT8070iE / MT6070iE / MT8100iE / MT8121iE / MT8150iE / MT8071iE / MT6071iE / MT8072iE / MT6072iE / MT8073iE / MT8101iE / MT8102iE / MT8103iE
MT-XE	MT8121XE / MT8150XE / MT8090XE

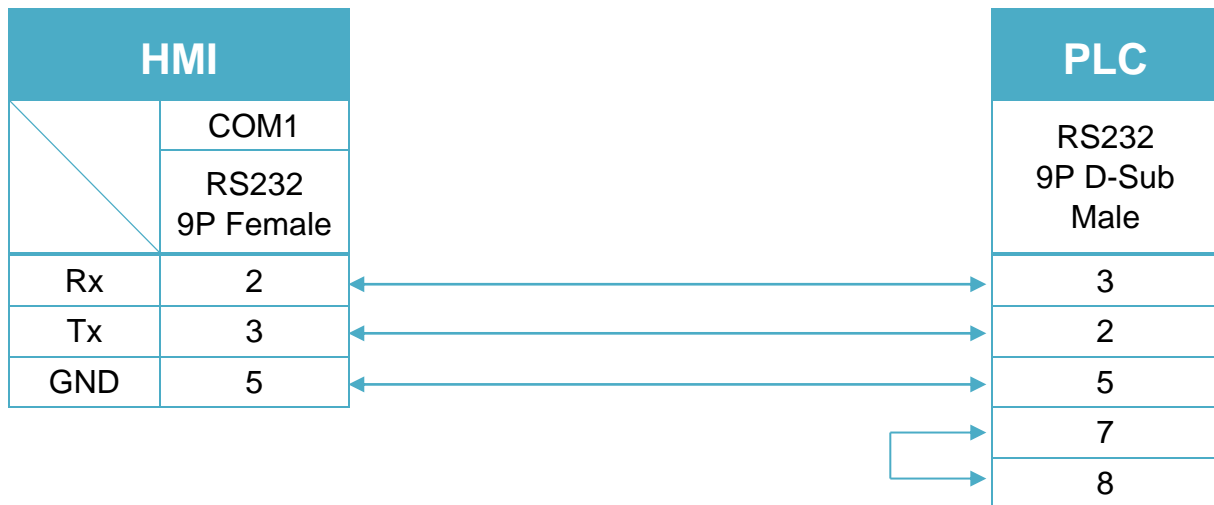
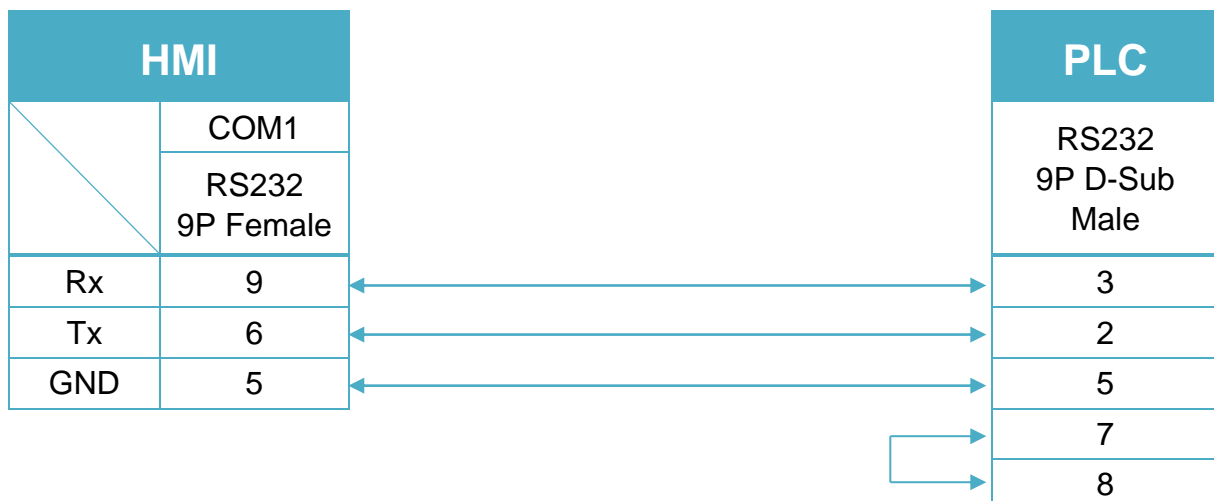


Diagram 3

MT-iE	MT8050iE
MT-iP	MT6051iP / MT6071iP / MT8071iP



YASKAWA CCMEP

Supported Series: YASKAWA CCMEP-100/ CCMEP-200

Website: <http://www.yaskawa-control.co.jp/english/jigyo/mechatronics.html>

HMI Setting:

Parameters	Recommended	Options	Notes
PLC type	YASKAWA CCMEP		
PLC I/F	RS485 4W		
Baud rate	38400		
Data bits	8		
Parity	Even		
Stop bits	1		
PLC sta. no.	1		

Device Address:

Bit/Word	Device type	Format	Range	Memo
B	4_Bit	DDDDDDdd	100 ~ 6553515	
W	4	DDDDD	1 ~ 65535	

Wiring Diagram:

RS-485 4W 8P RJ45 (Diagram1~ Diagram4)

Diagram 1

cMT Series	<i>cMT3151</i>
eMT Series	<i>eMT3070 / eMT3105 / eMT3120 / eMT3150</i>
MT-iE	<i>MT8070iE / MT6070iE / MT8100iE / MT8121iE / MT8150iE</i>
MT-XE	<i>MT8121XE / MT8150XE</i>

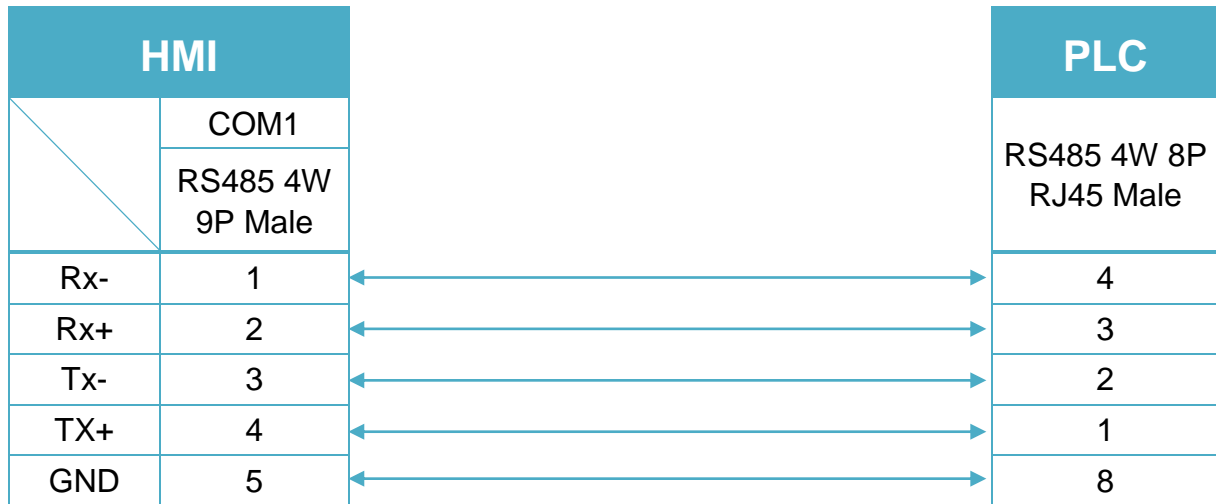


Diagram 2

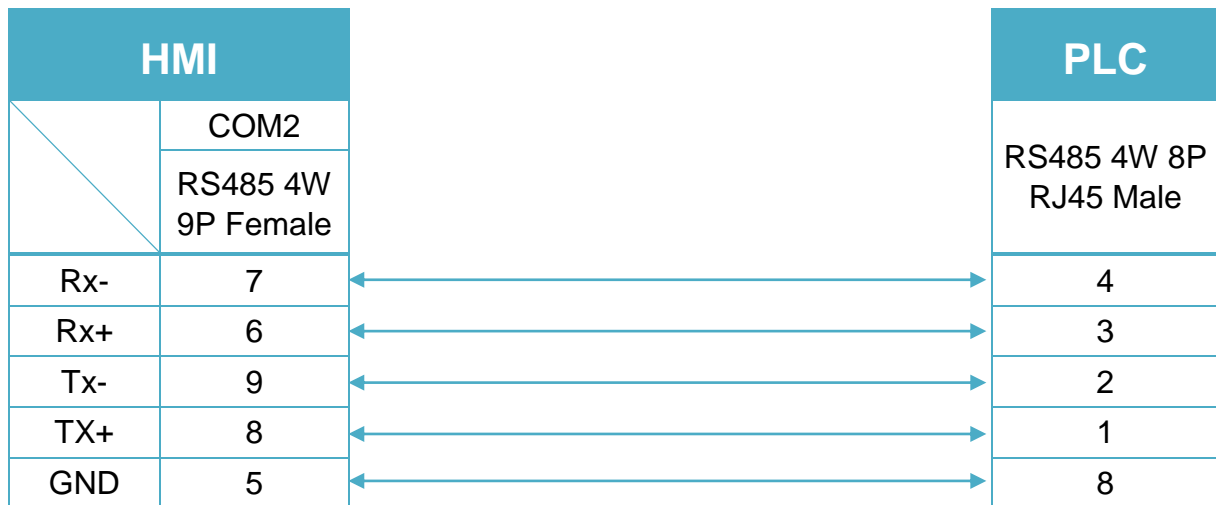
cMT Series
cMT-SVR
mTV
mTV


Diagram 3

MT-iE	<i>MT8071iE / MT6071iE / MT8072iE / MT6072iE / MT8073iE / MT8101iE / MT8102iE / MT8103iE</i>
MT-XE	<i>MT8090XE / MT8092XE</i>
MT-iP	<i>MT6071iP / MT8071iP / MT6103iP</i>

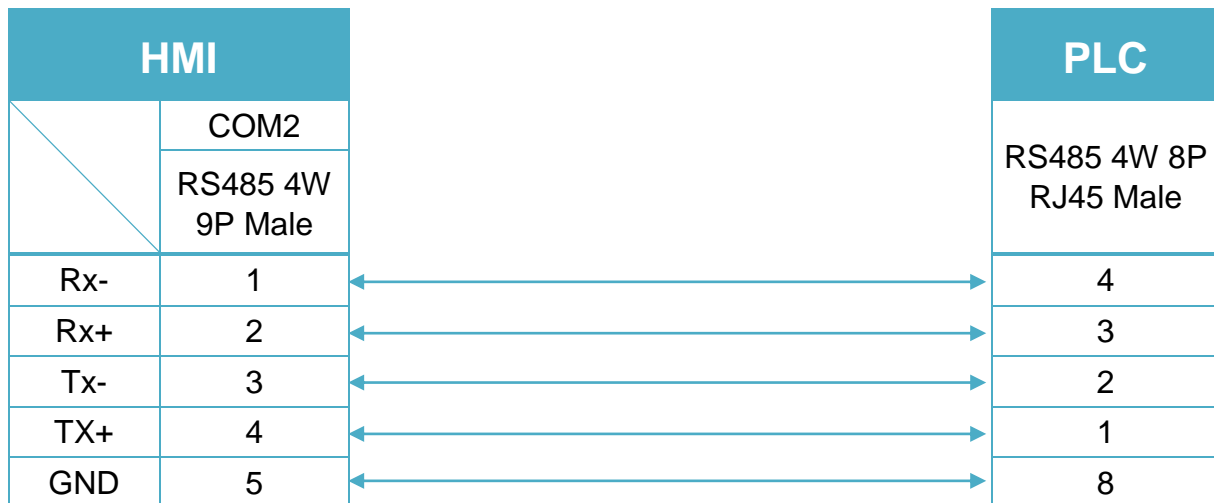
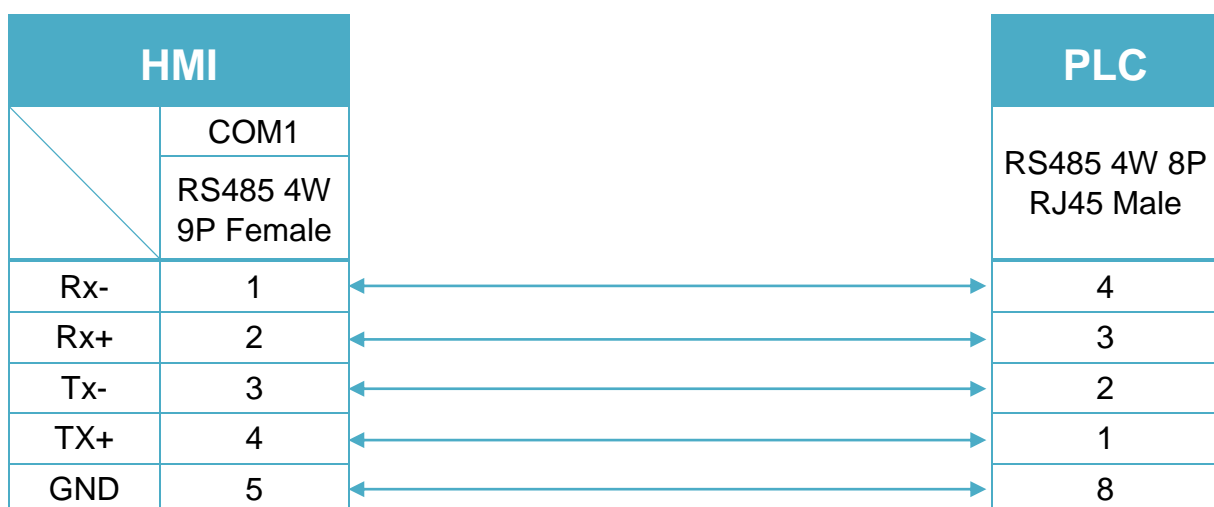


Diagram 4

MT-iE	<i>MT8050iE</i>
MT-iP	<i>MT6051iP</i>



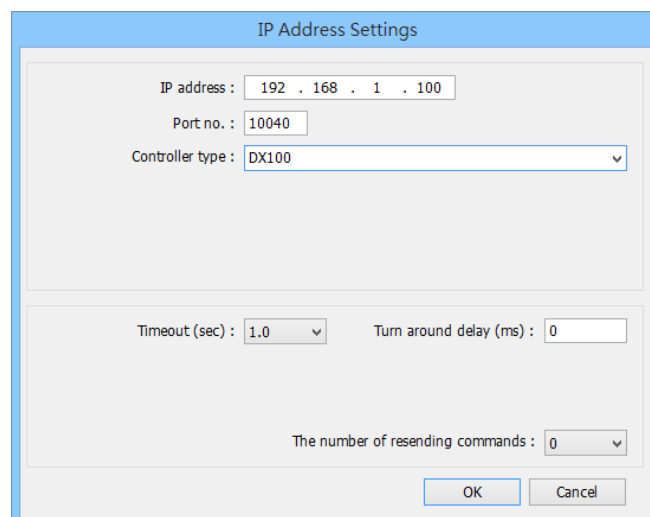
YASKAWA DX100/DX200/FS100/YRC1000 Robot Controller (Ethernet)

Supported Series: YASKAWA controller type DX100, FS100, DX200, YRC1000

Website: <http://www.yaskawa.com/>

HMI Setting:

Parameters	Recommended	Options	Notes
PLC type	YASKAWA DX100/DX200/FS100/YRC1000 Robot Controller (Ethernet)		
PLC I/F	Ethernet (UDP)		
Port no.	10040		
Controller type	DX100	DX100, FX100, DX200, YRC1000	



The screenshot shows a dialog box titled "IP Address Settings". It contains the following fields:

- IP address: 192 . 168 . 1 . 100
- Port no.: 10040
- Controller type: DX100 (dropdown menu)
- Timeout (sec): 1.0 (dropdown menu)
- Turn around delay (ms): 0
- The number of resending commands: 0 (dropdown menu)

At the bottom right, there are "OK" and "Cancel" buttons.

Device Address:

Bit/Word	Device type (Command)	Format	Range
B	Status_Bit	DDDDDDDDdd	0 ~ 163836331
B	Robot_Position_Bit	DDDDDDDDdd	0 ~ 163836331
B	IO_Data_Bit	DDDDDo	0 ~ 163837
B	Register_Data_Bit	DDDDDDdd	0 ~ 1638315
B	B_Bit	DDDDDo	0 ~ 163837
B	I_Bit	DDDDDDdd	0 ~ 1638315
B	D_Bit	DDDDDDdd	0 ~ 1638331
B	R_Bit	DDDDDDdd	0 ~ 1638331

Bit/Word	Device type (Command)	Format	Range
B	P_Bit	DDDDDDDDdd	0 ~ 163836331
W	Administration_Hour	DDDDDDDDDD	0 ~ 163836300
W	Alarm	DDDDDDDDDD	0 ~ 163836300
W	Alarm_Detailed	DDDDDDDDDD	0 ~ 163836300
W	Alarm_History	DDDDDDDDDD	0 ~ 163836300
W	Alarm_History_Detailed	DDDDDDDDDD	0 ~ 163836300
W	Axis_Composition	DDDDDDDDDD	0 ~ 163836300
W	B	DDDDD	0 ~ 16383
W	BP	DDDDDDD	0 ~ 163363
W	D	DDDDD	0 ~ 16383
W	Axis_Position_Deflection	DDDDDDD	0 ~ 1638363
W	Each_Shaft_Torque	DDDDDDD	0 ~ 1638363
W	EX	DDDDDDD	0 ~ 1638363
W	I	DDDDD	0 ~ 16383
W	IO_Data	DDDDD	0 ~ 16383
W	Job_Information	DDDDDDDDDD	0 ~ 163836300
W	Job_Select	DDDDDDDDDD	0 ~ 163836300
W	On_Off	DDDDD	0 ~ 16383
W	P	DDDDDDD	0 ~ 1638363
W	R	DDDDD	0 ~ 16383
W	Register_Data	DDDDD	0 ~ 16383
W	Reset_Cancellation	DDDDD	0 ~ 16383
W	Robot_Position	DDDDDDD	0 ~ 1638363
W	S	DDDDDDD	0 ~ 1638300
W	Start	DDDDDDD	0 ~ 1638363
W	State_Switch	DDDDD	0 ~ 16383
W	Status	DDDDDDD	0 ~ 1638363
W	String_Display_To_Pendant	DDDDDDD	0 ~ 1638300
W	System_Information	DDDDDDDDDD	0 ~ 163836300
W	S_32BYTE	DDDDDDD	0 ~ 1638300
W	Move_Instruction_Cartesian	DDDDDDD	0 ~ 1638300
W	Move_Instruction_Pluse	DDDDDDD	0 ~ 1638300

Wiring Diagram:

Ethernet cable



YASKAWA MP Series - Extension (Ethernet)

HMI Setting:

Parameters	Recommended	Options	Notes
PLC type	YASKAWA MP Series - Extension (Ethernet)		
PLC I/F	Ethernet (UDP)		
Port no.	10000		
PLC sta. no.	1		

PLC Setting:

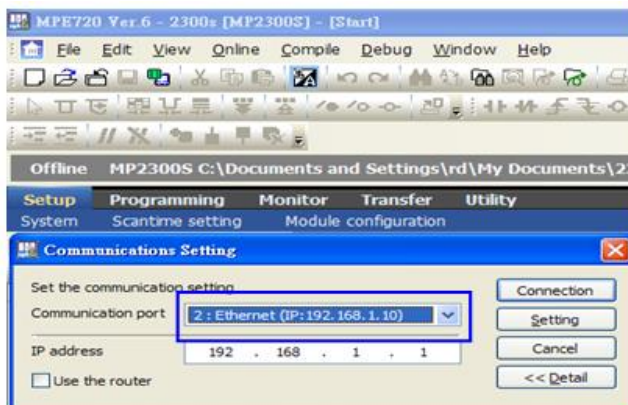
Yaskawa PLC Communication Parameter Settings

(1) PLC Factory Communication Parameter Settings:

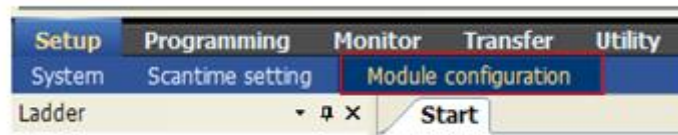
Item	Set
IP Address	192.168.1.1
Subnet Mask	255.255.255.0
Gateway IP Address	0.0.0.0
System Port No.	10000 (UDP)
TCP Zero Window Timer Value	3 (s)
TCP Retry Time	500 (ms)
TCP Close Time	60 (s)
IP Assemble Time	30 (s)
Max. Packet Length	1500 (bytes)

(2) Setting Steps:

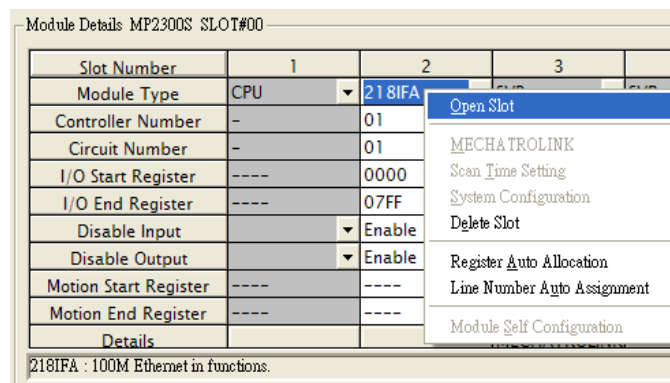
1. Set IP for PLC.



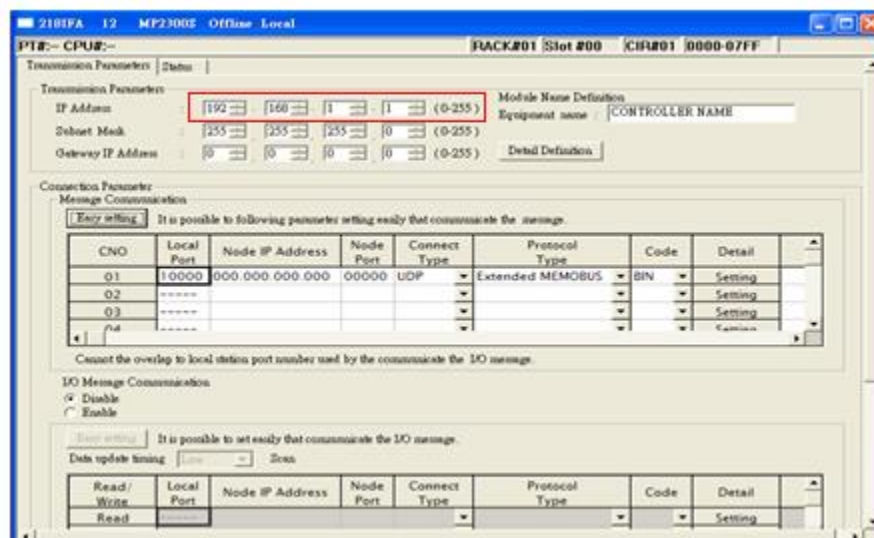
2. Communication parameter setting.



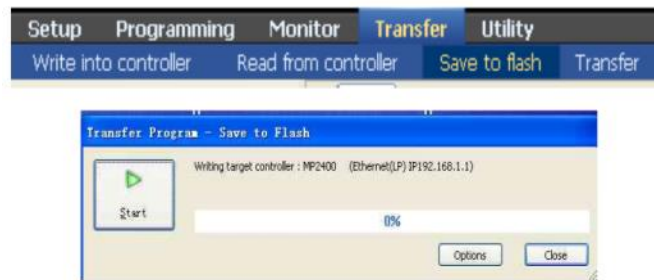
3. Go to Module Details and select [2181FA] for setting relevant parameters for Ethernet transmission.



4. The settings are shown below, PLC IP can't be repeated.



5. Download PLC communication parameters to PLC, and restart the controller.



(3) HMI Settings:

1. Select Ethernet for PLC I/F.
2. Tick [UDP].
3. Set PLC IP and Port, the default Port is 10000.



Device Address:

Bit/Word	Device type	Format	Range	Memo
B	SB	DDDDh	0 ~ 8191f	
B	IB	HHHHh	0 ~ ffff	
B	OB	HHHHh	0 ~ ffff	
B	MB	DDDDh	0 ~ 65534f	
W	SW	DDDD	0 ~ 8191	
W	IW	HHHH	0 ~ ffff	
W	OW	HHHH	0 ~ ffff	
W	MW	DDDD	0 ~ 65534	
DW	ML	DDDD	0 ~ 65534	

Wiring Diagram:

Ethernet cable



YASKAWA MP Series - Memobus

Supported Series: YASKAWA MP2200, MP2300, MP2300S, MP9xx communication module.

Website: <http://www.yaskawa.com/>

HMI Setting:

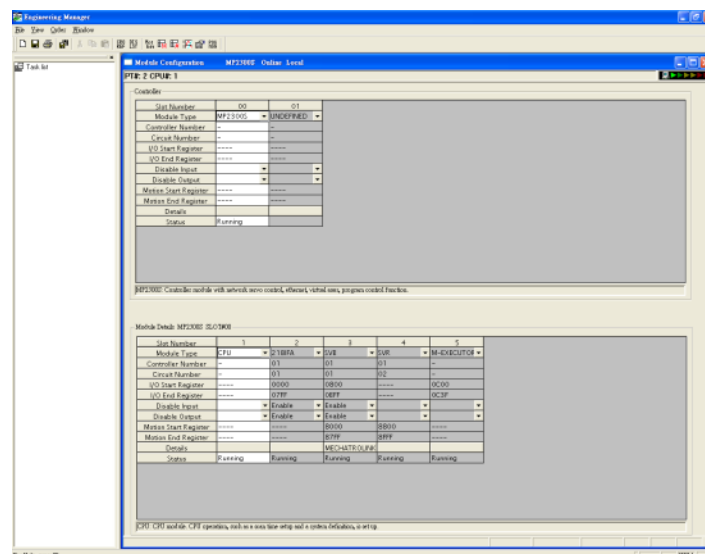
Parameters	Recommended	Options	Notes
PLC type	YASKAWA MP Series - Memobus		
PLC I/F	RS485/Ethernet	RS232/RS485 2w/4w, Ethernet	
Baud rate	19200	9600~57600	
Data bits	8		
Parity	Even		
Stop bits	1		
Port no.	502	default	Ethernet Module Only
PLC sta. no.	1	1-31	

PLC Setting:

Communication mode	MEMOBUS, Slave, RTU
---------------------------	---------------------

PLC Ethernet Setting:

1. Use MPE720 program software, open Module Configuration, double click "218IFA".



- In Transmission Parameters input MP2300S IP address, Subnet Mask, Gateway IP. In Connection Parameter, CNO -1 input: Local Port=502, Node IP address=000.000.000.000, Node Port=00000, Connect Type=TCP, Protocol Type=MEMOBUS, Code=RTU.

Parameters : . . . (0-255) Module Name Definition
 Equipment name : CONTROLLER B
 : . . . (0-255)
 : . . . (0-255)

It is possible to following parameter setting easily that communicate the message.

Local Port	Node IP Address	Node Port	Connect Type	Protocol Type	Code
00502	000.000.000.000	00000	TCP	MEMOBUS	RTU

It is possible to set easily that communicate the I/O message.

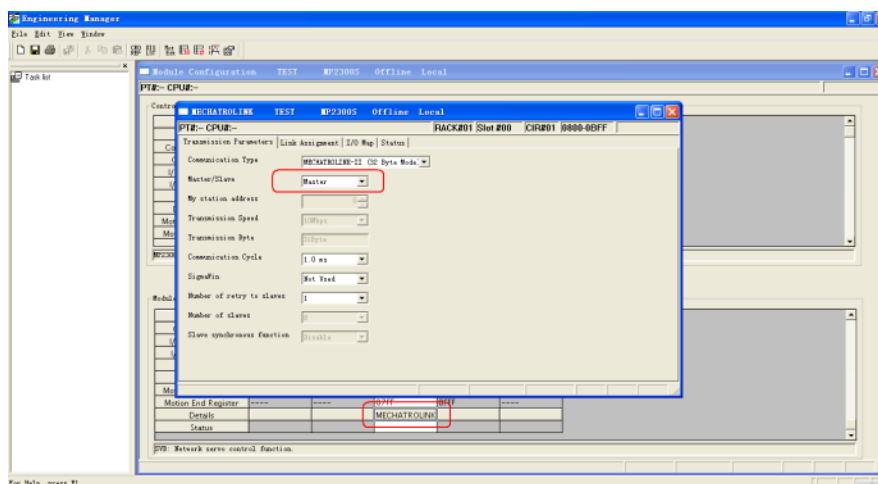
Input/Output : Scan

Local Port	Node IP Address	Node Port	Connect Type	Protocol Type	Code

Head register number data size Head register number data size

input disable	IW0000	4	W <-	Hold register(MW)	00000	4	W	Node eq
output disable	OW0004	4	W ->	Hold register(MW)	00004	4	W	

- Click MECHATROLINK to set up MP2300S PLC as Master.



- Close all dialogs and save to MP2300S.

Note:

1. Only CNO 01 can auto communicate with one HMI. Other CNO need a ladder program created for communication.
2. DIP SW2-2 of MP2300S must be set to OFF position during normal communication, otherwise, IP address will be erased after reset power, and it will be unable to communicate with HMI when set to ON position.

Device Address:

Bit/Word	Device type	Format	Range	Memo
B	MB_1	DDDDh	0 ~ 9999f	MB 0 ~ 9999
B	MB_2	DDDDh	100000 ~ 65534f	MB 10000 ~ 65535
B	IB	HHHHH	0 ~ a7ff0	Read only
B	IW_Bit	HHHHdd	0~ a7ff15	
W	IW	HHHH	0 ~ a7ff	Read only
DW	IL	HHHH	0 ~ a7ff	Read only
DW (F)	IF	HHHH	0 ~ a7ff	Read only
W	MW	DDDDD	0 ~ 65534	Holding register
DW	ML	DDDDD	0 ~ 65533	Double word
DW (F)	MF	DDDDD	0 ~ 65533	Floating point

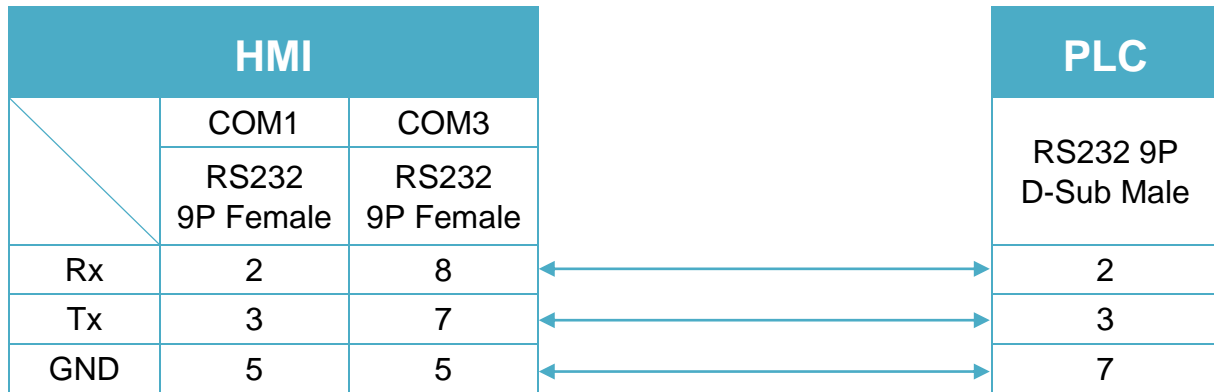
*: When connect via Ethernet interface the max range of IW, IL and IF would be restricted.

Wiring Diagram:

RS-232 9P D-Sub (Diagram1~ Diagram3)

Diagram 1

cMT Series	<i>cMT3151</i>
eMT Series	<i>eMT3070/ eMT3105 / eMT3120 / eMT3150</i>
MT-iE	<i>MT8073iE / MT8102iE</i>
MT-XE	<i>MT8092XE</i>
MT-iP	<i>MT6103iP</i>


Diagram 2

cMT Series	<i>cMT-SVR</i>
mTV	<i>mTV</i>
MT-iE	<i>MT8070iE / MT6070iE / MT8100iE / MT8121iE / MT8150iE / MT8071iE / MT6071iE / MT8072iE / MT6072iE / MT8073iE / MT8101iE / MT8102iE / MT8103iE</i>
MT-XE	<i>MT8121XE / MT8150XE / MT8090XE</i>

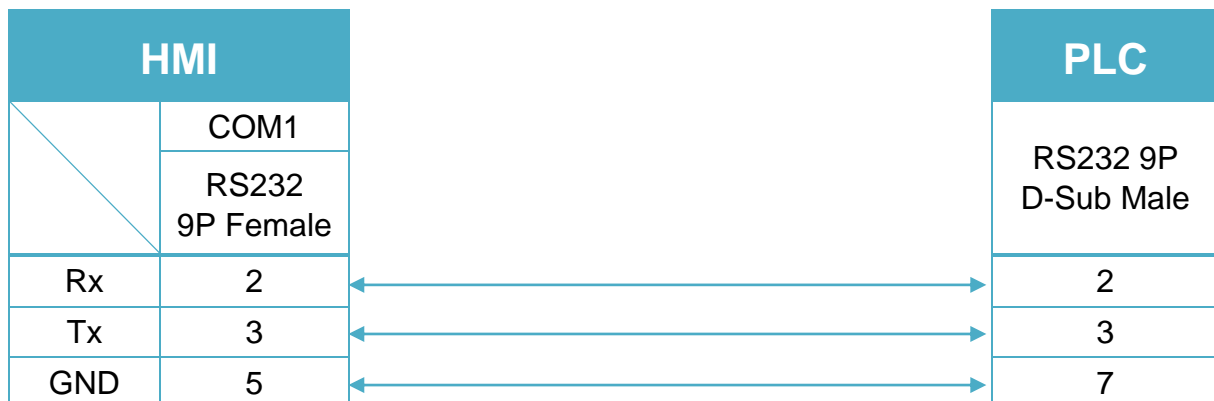


Diagram 3

MT-iE
MT8050iE
MT-iP
MT6051iP / MT6071iP / MT8071iP


217IF-01 RS485 14 P Connector (Diagram4~ Diagram10)

Diagram 4

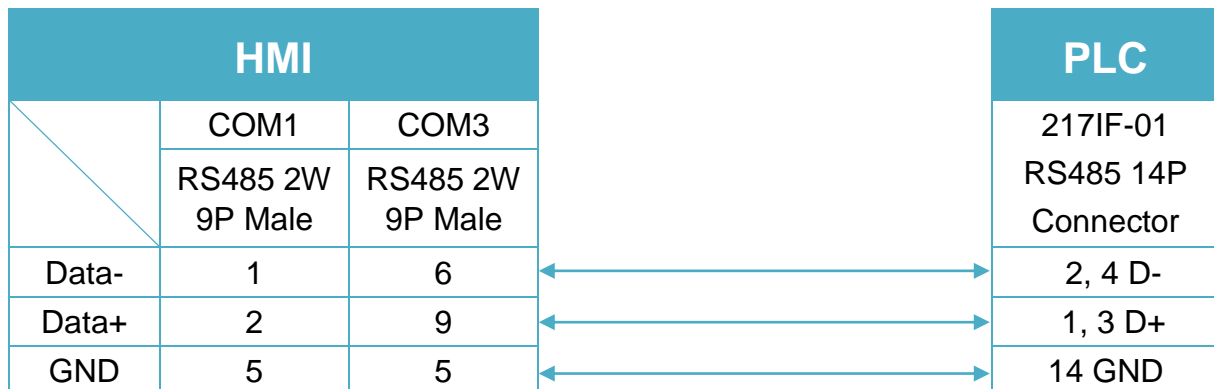
cMT Series
cMT3151
eMT Series
eMT3070/ eMT3105 / eMT3120 / eMT3150


Diagram 5

cMT Series *cMT-SVR*

mTV *mTV*

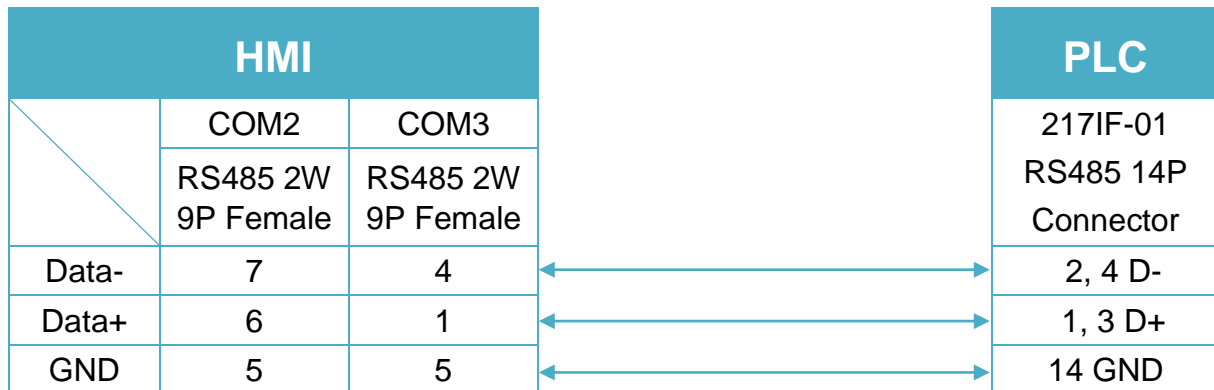


Diagram 6

MT-iE *MT8070iE / MT6070iE / MT8100iE / MT8121iE / MT8150iE*

MT-XE *MT8121XE / MT8150XE*

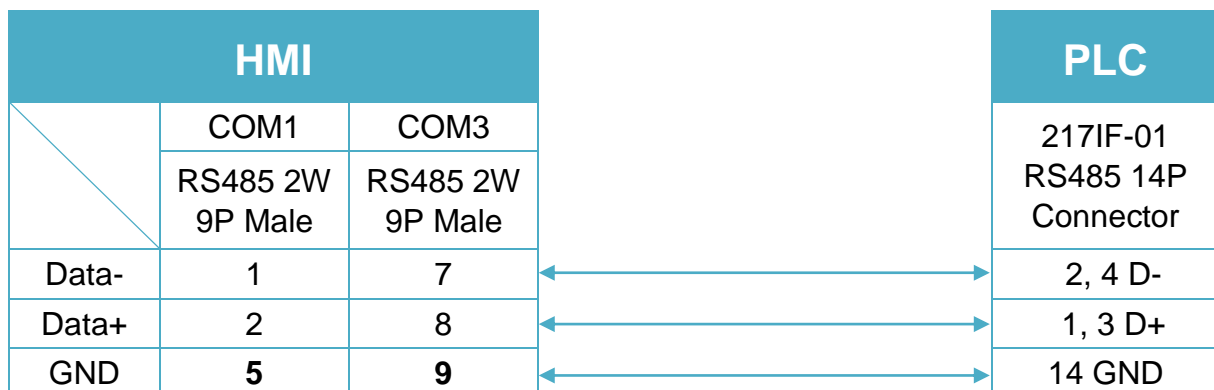


Diagram 7

MT-iE	<i>MT8071iE / MT6071iE / MT8072iE / MT6072iE / MT8073iE / MT8101iE / MT8102iE / MT8103iE</i>
MT-XE	<i>MT8090XE / MT8092XE</i>
MT-iP	<i>MT6103iP</i>

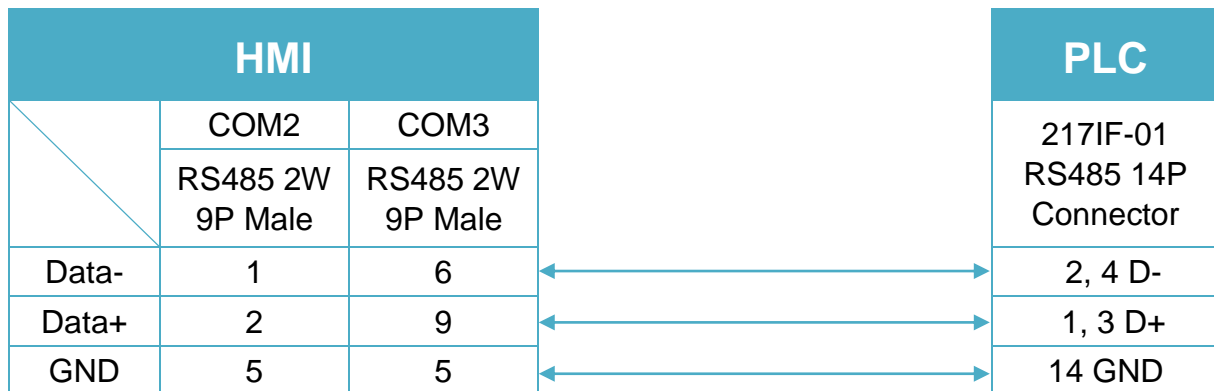


Diagram 8

MT-iE	<i>MT8050iE</i>
MT-iP	<i>MT6051iP</i>

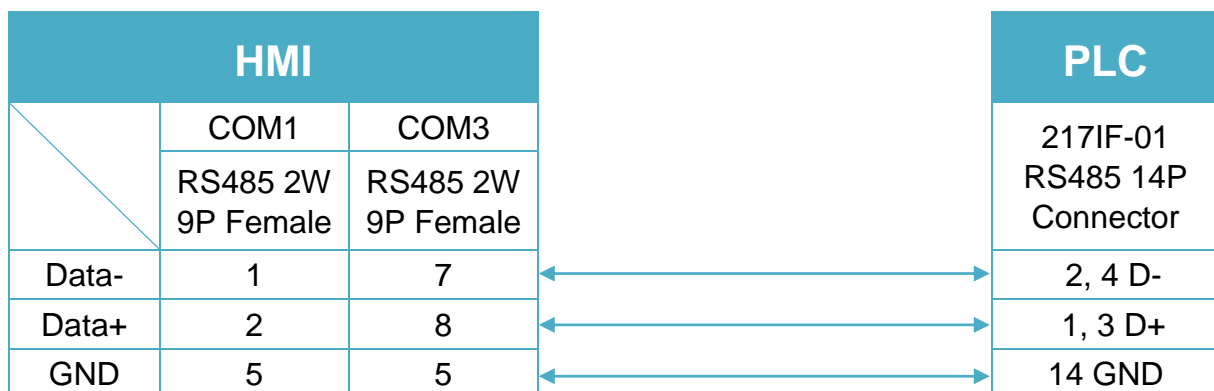


Diagram 9

MT-iP *MT6071iP / MT8071iP*



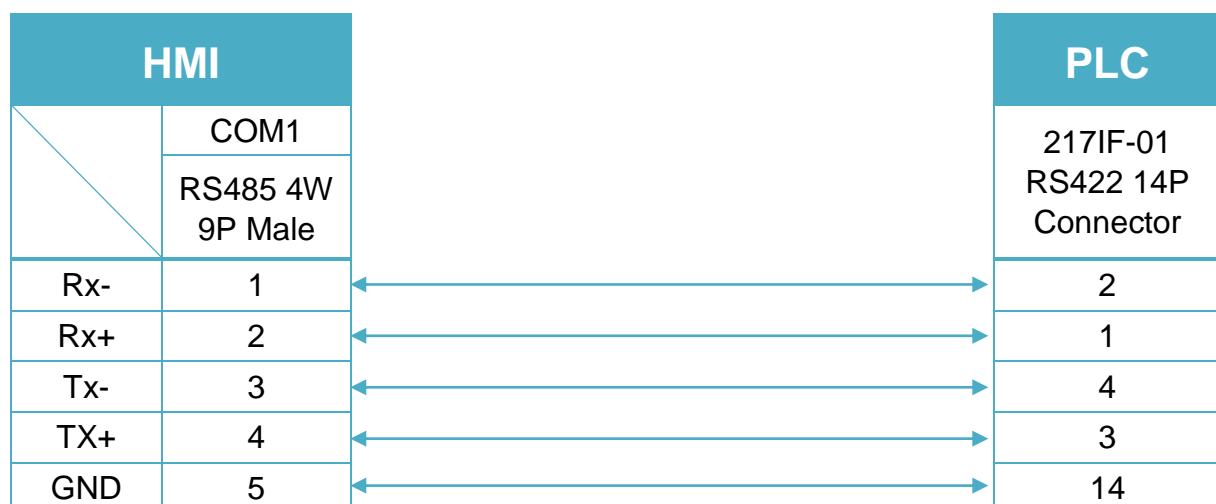
Diagram 10

cMT Series *cMT3151*

eMT Series *eMT3070 / eMT3105 / eMT3120 / eMT3150*

MT-iE *MT8070iE / MT6070iE / MT8100iE / MT8121iE / MT8150iE*

MT-XE *MT8121XE / MT8150XE*



217IF-01 RS422 14 P Connector (Diagram11~ Diagram13)

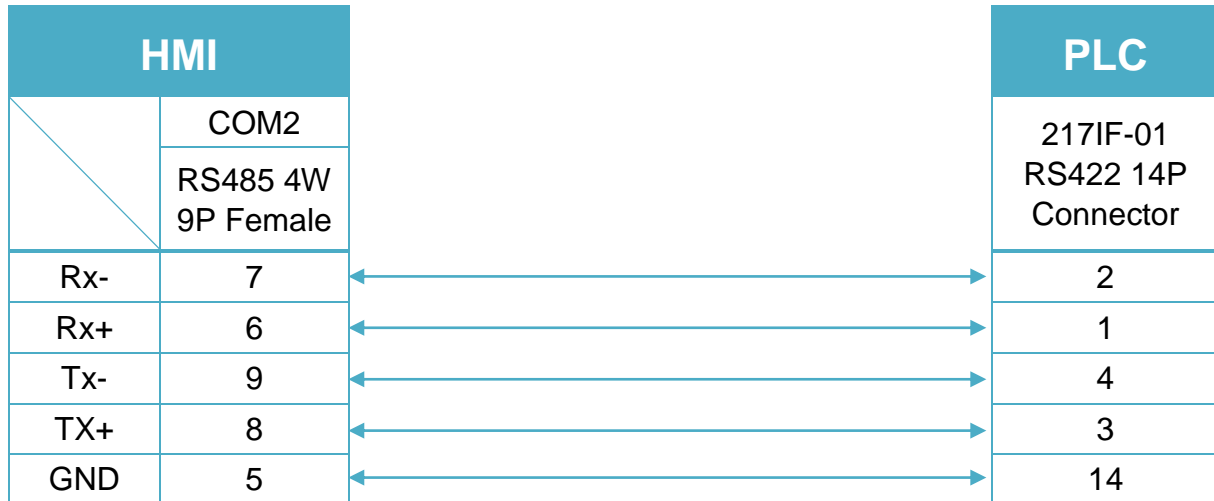
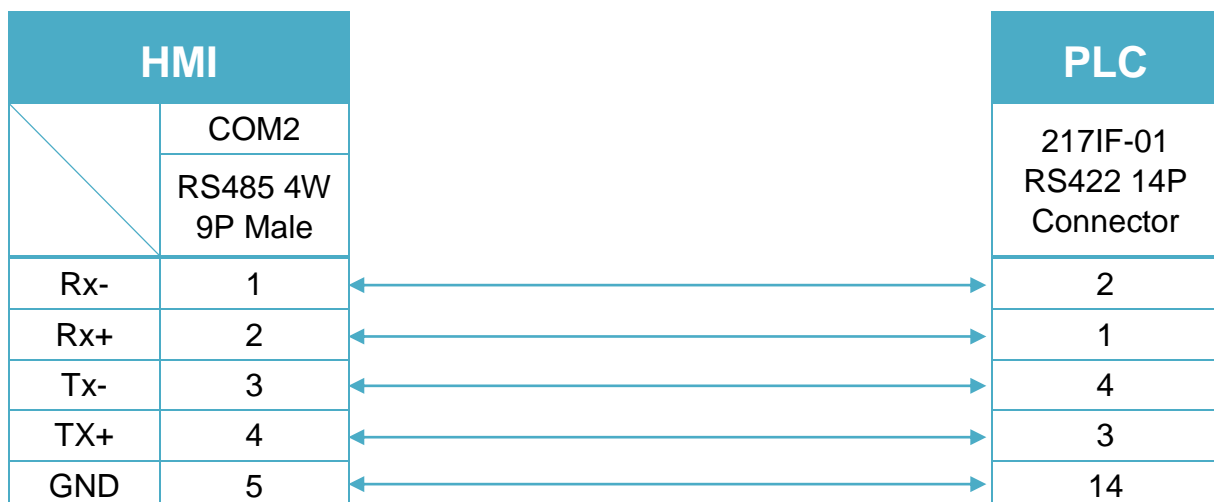
Diagram 11
cMT Series *cMT-SVR*
mTV *mTV*

Diagram 12
MT-iE *MT8071iE / MT6071iE / MT8072iE / MT6072iE / MT8073iE /
MT8101iE / MT8102iE / MT8103iE*
MT-XE *MT8090XE / MT8092XE*
MT-iP *MT6071iP / MT8071iP / MT6103iP*


Diagram 13

MT-iE *MT8050iE*

MT-iP *MT6051iP*

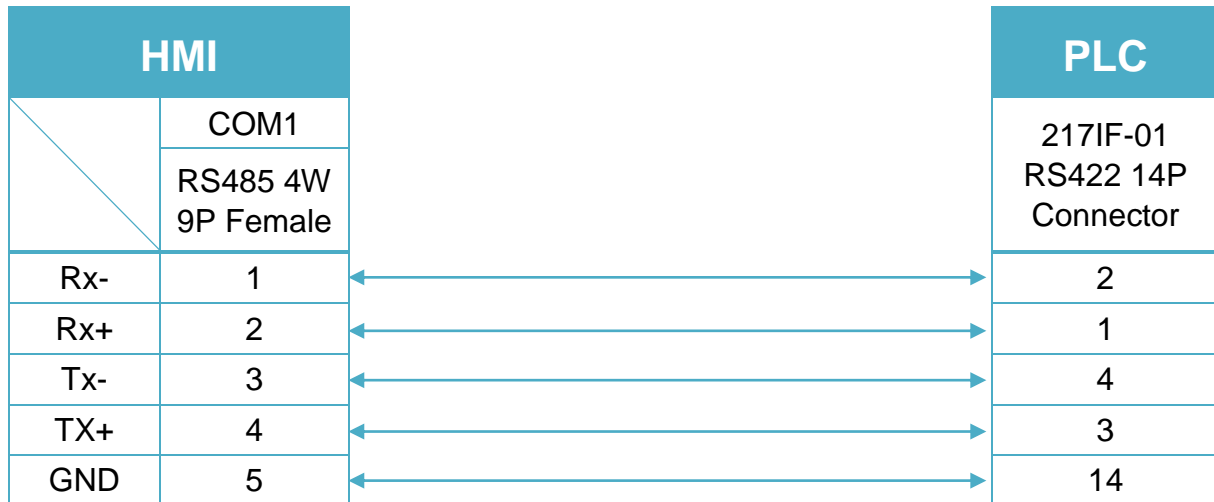


Diagram 14

Ethernet cable:



YASKAWA MP Series Memobus (Ethernet)

Supported Series: YASKAWA MP2200, MP2300, MP2300S, MP9xx with 218IF-02 ethernet module.

Website: <http://www.yaskawa.com/>

HMI Setting:

Parameters	Recommended	Options	Notes
PLC type	YASKAWA MP Series Memobus (Ethernet)		
PLC I/F	Ethernet		
Port no.	502		

PLC Setting:

How to connect one Yaskawa Ethernet device with multiple HMIs?

http://www.weintek.com/Download/MT8000/eng/FAQ/FAQ_61_How_to_connect_Yaskawa_Ethernet.pdf

Device Address:

Bit/Word	Device type	Format	Range	Memo
B	MB	DDDDh	0 ~ 65534F	
B	IB	HHHHH	0 ~ A7FFF	Read only
B	IW_Bit	HHHHdd	0 ~ A7FF15	Read only
W	IW	HHHH	0 ~ A7FF	Read only
DW	IL	HHHH	0 ~ A7FF	Read only
DW	IF	HHHH	0 ~ A7FF	Float , Read only
W	MW	DDDDD	0 ~ 65534	
DW	ML	DDDDD	0 ~ 65533	
DW	MF	DDDDD	0 ~ 65533	Float

Wiring Diagram:

Ethernet cable



YASKAWA MP Series SIO (Extension)

Supported Series: YASKAWA MP2200, MP2300, MP2300S, MP9xx communication module.

Website: <http://www.yaskawa.com/>

HMI Setting:

Parameters	Recommended	Options	Notes
PLC type	YASKAWA MP Series SIO (Extension)		
PLC I/F	RS485	RS232/RS485 2w/4w	
Baud rate	19200	9600~57600	
Data bits	8		
Parity	Even		
Stop bits	1		
PLC sta. no.	1	1-31	

Device Address:

Bit/Word	Device type	Format	Range	Memo
B	SB	DDDDh	0 ~ 8191F	
B	IB	HHHHh	0 ~ FFFFF	
B	OB	HHHHh	0 ~ FFFFF	
B	MB	DDDDh	0 ~ 65534F	
W	SW	DDDD	0 ~ 8191	
W	IW	HHHH	0 ~ FFFF	
W	OW	HHHH	0 ~ FFFF	
W	MW	DDDD	0 ~ 65534	

Wiring Diagram:

RS-232 9P D-Sub (Diagram1~ Diagram3)

Diagram 1

cMT Series	<i>cMT3151</i>
eMT Series	<i>eMT3070/ eMT3105 / eMT3120 / eMT3150</i>
MT-iE	<i>MT8073iE / MT8102iE</i>
MT-XE	<i>MT8092XE</i>
MT-iP	<i>MT6103iP</i>

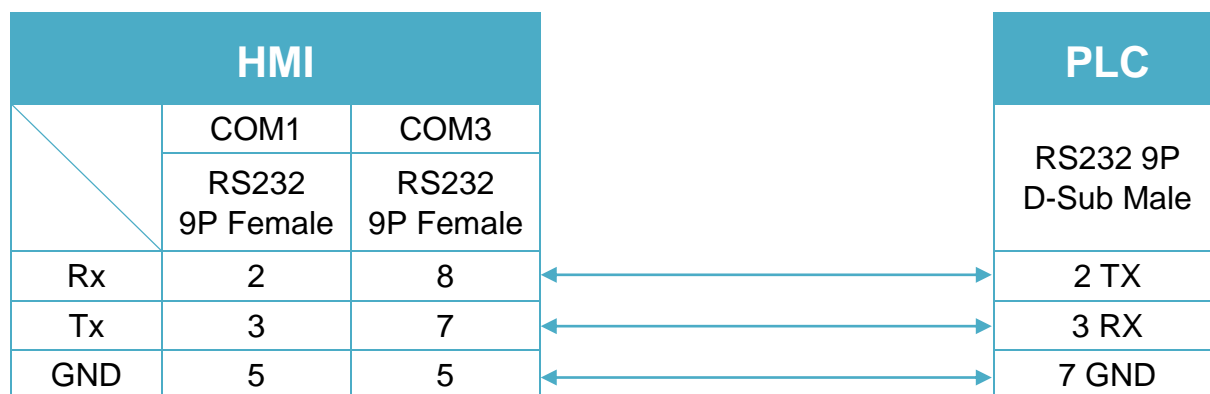


Diagram 2

cMT Series	cMT-SVR
mTV	mTV
MT-iE	MT8070iE / MT6070iE / MT8100iE / MT8121iE / MT8150iE / MT8071iE / MT6071iE / MT8072iE / MT6072iE / MT8073iE / MT8101iE / MT8102iE / MT8103iE
MT-XE	MT8121XE / MT8150XE / MT8090XE

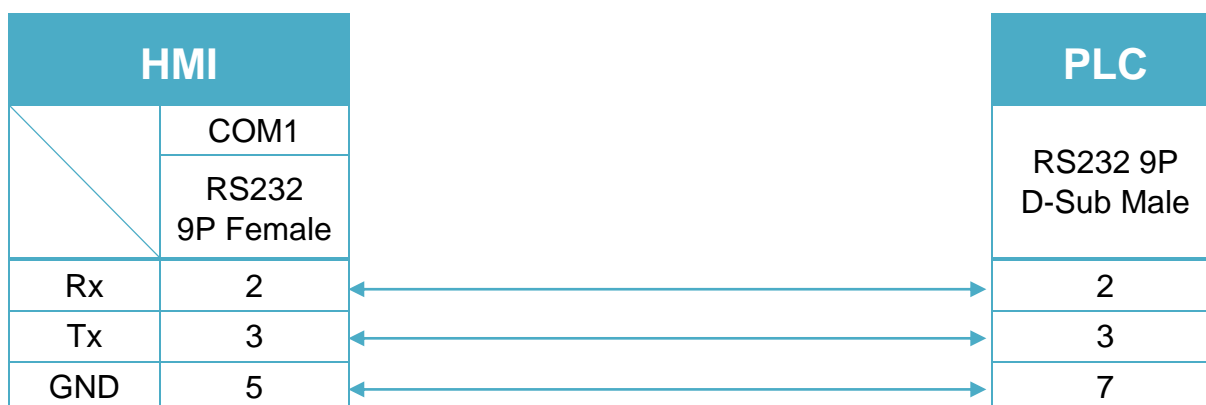
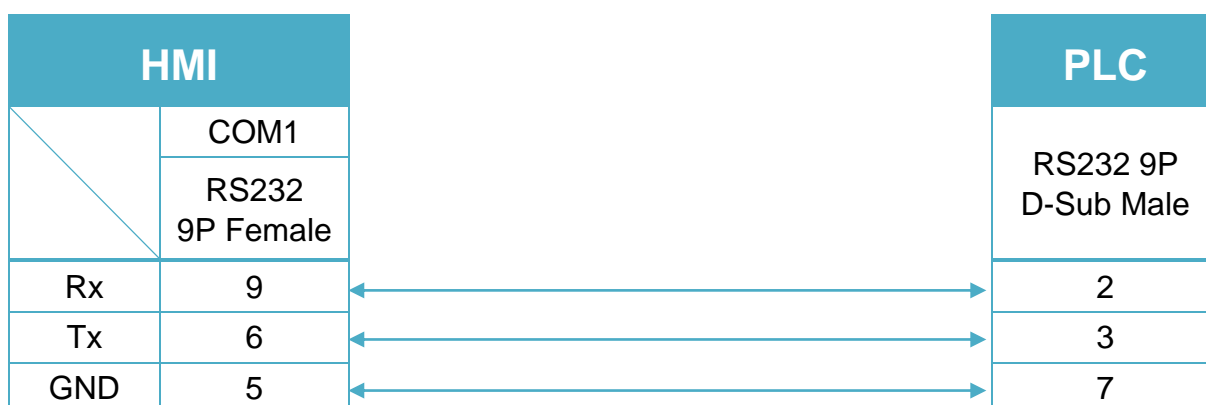


Diagram 3

MT-iE	MT8050iE
MT-iP	MT6051iP / MT6071iP / MT8071iP



217IF-01 RS485 14P Connector (Diagram4~ Diagram9)

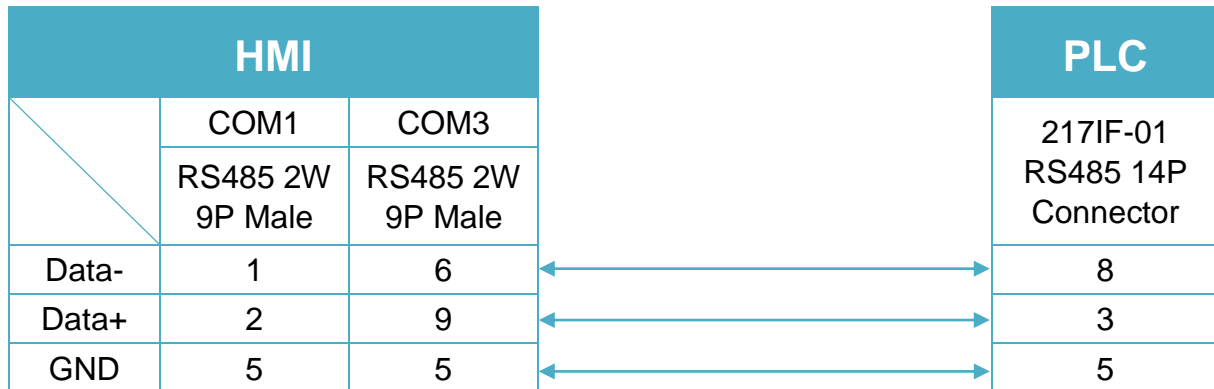
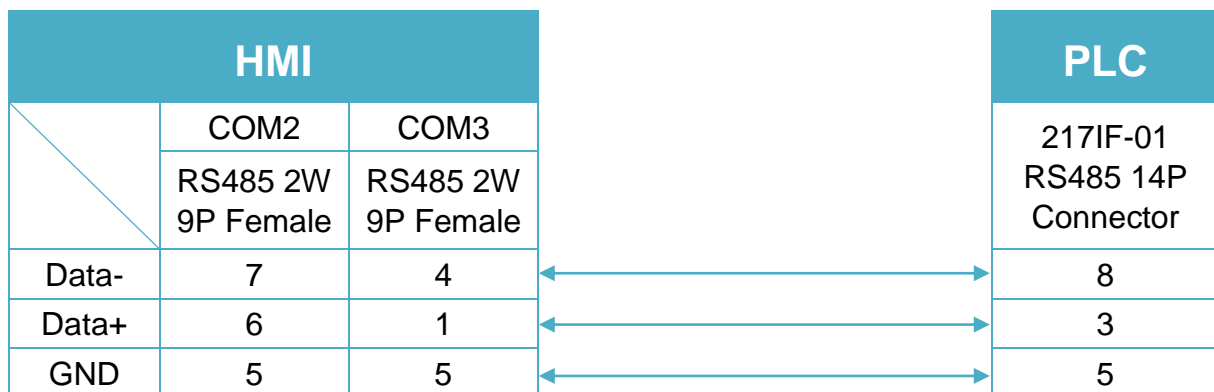
Diagram 4
cMT Series
cMT3151
eMT Series
eMT3070 / eMT3105 / eMT3120 / eMT3150

Diagram 5
cMT Series
cMT-SVR
mTV
mTV


Diagram 6

MT-iE *MT8070iE / MT6070iE / MT8100iE / MT8121iE / MT8150iE*

MT-XE *MT8121XE / MT8150XE*

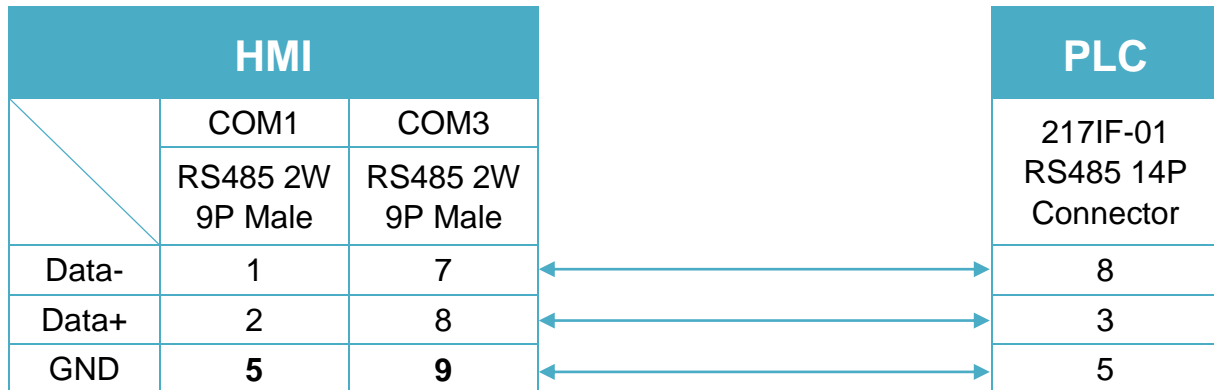


Diagram 7

MT-iE *MT8071iE / MT6071iE / MT8072iE / MT6072iE / MT8073iE /
MT8101iE / MT8102iE / MT8103iE*

MT-XE *MT8090XE / MT8092XE*

MT-iP *MT6103iP*

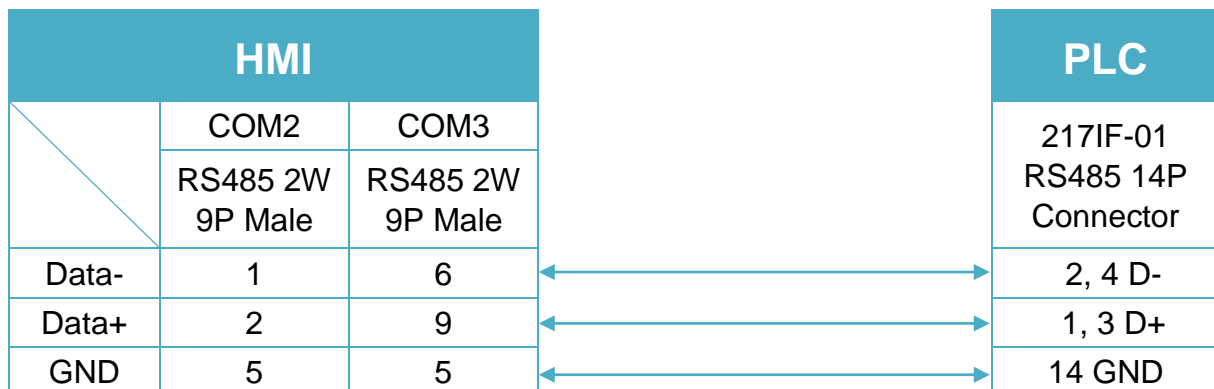
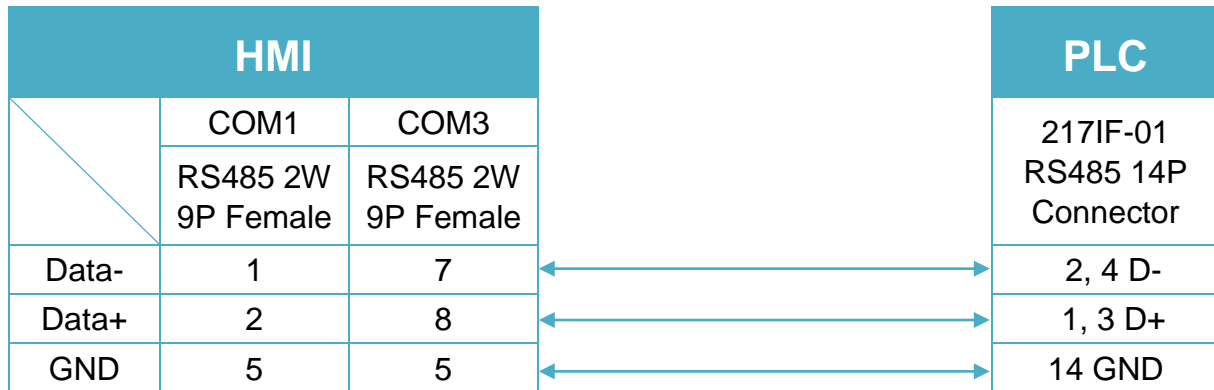
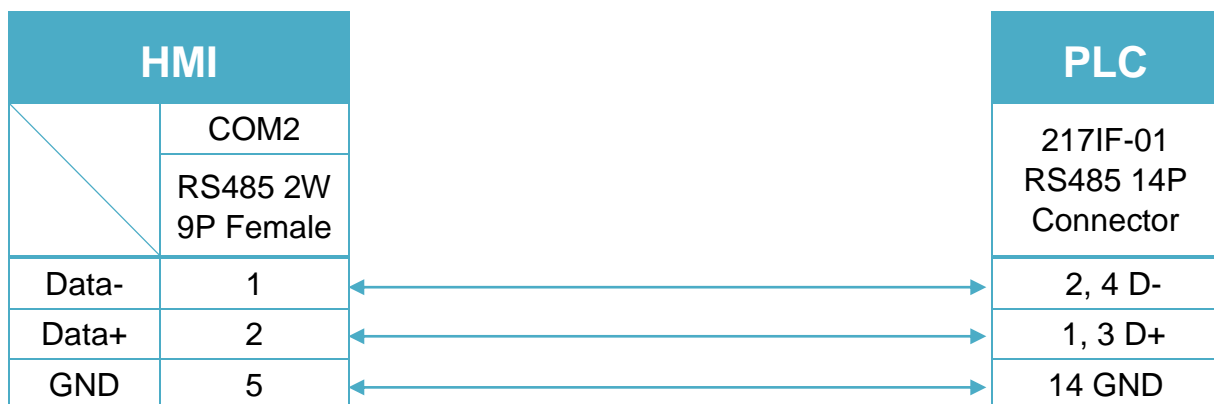


Diagram 8
MT-iE *MT8050iE*
MT-iP *MT6051iP*

Diagram 9
MT-iP *MT6071iP / MT8071iP*


YASKAWA MP2300Siec (Ethernet)

Website: <http://www.yaskawa.com/site/home.nsf/home/home.html>

HMI Setting:

Parameters	Recommended	Options	Notes
PLC type	YASKAWA MP2300Siec (Ethernet)		
PLC I/F	Ethernet		
Port no.	44818		
Assembly instance	Input::101 Output:111	Input::101~106 Output:111~116	

PLC Setting:

MP2300Siec-Motion Works IEC Express (YASKAWA) Settings:

Step 1. Before HMI communicates with MP2300Siec using Ethernet/IP, the Instance Input and Instance Output of MP2300Siec device must be set correctly. Multiple Instances are allowed to be built at one time, please click [Save] after setting.

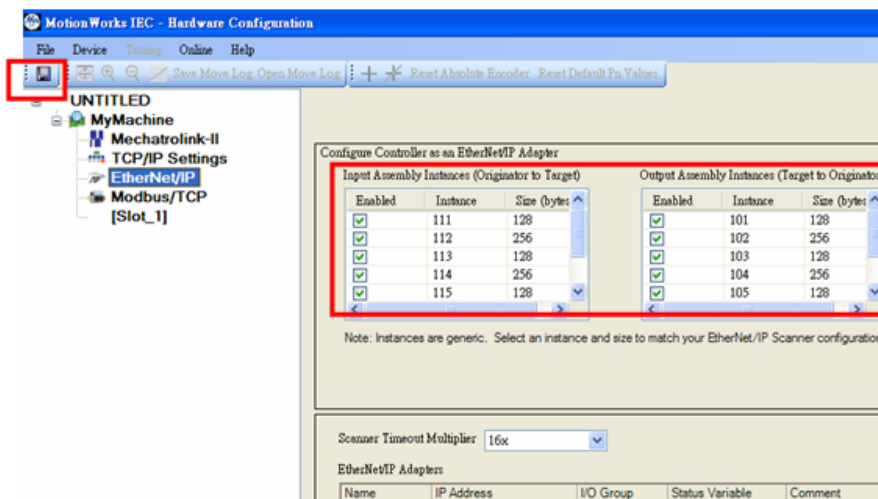


Fig. 1 Assembly Instances

Step 2. Global Variables will automatically add in E/IP Input and Output data, Input and Output data name and address type can be user-defined.

Name	Type	Usage	Description	Address	Init	Retain	PDD	OPC	TB
PLC_TASK_6	EXT_TASK_IN...	VAR_GLO...		\$MB11324					
PLC_TASK_7	EXT_TASK_IN...	VAR_GLO...		\$MB11388					
PLC_TASK_8	EXT_TASK_IN...	VAR_GLO...		\$MB11452					
PLC_TASK_9	EXT_TASK_IN...	VAR_GLO...		\$MB11516					
PLC_TASK_10	EXT_TASK_IN...	VAR_GLO...		\$MB11580					
PLC_TASK_11	EXT_TASK_IN...	VAR_GLO...		\$MB11644					
PLC_TASK_12	EXT_TASK_IN...	VAR_GLO...		\$MB11708					
PLC_TASK_13	EXT_TASK_IN...	VAR_GLO...		\$MB11772					
PLC_TASK_14	EXT_TASK_IN...	VAR_GLO...		\$MB11836					
PLC_TASK_15	EXT_TASK_IN...	VAR_GLO...		\$MB11900					
PLC_TASK_16	EXT_TASK_IN...	VAR_GLO...		\$MB11964					
Use Variables									
NewVar260	DWORD	VAR_GLO...							
E/IP Output Instance #101, Qty: 128 Bytes, Address Range: \$QB21488-\$QB21615									
E/IP Output Instance #102, Qty: 256 Bytes, Address Range: \$QB22000-\$QB22235									
E/IP Output Instance #103, Qty: 128 Bytes, Address Range: \$QB22512-\$QB22639									
E/IP Output Instance #104, Qty: 256 Bytes, Address Range: \$QB23024-\$QB23279									
E/IP Output Instance #105, Qty: 128 Bytes, Address Range: \$QB23536-\$QB23663									
E/IP Output Instance #106, Qty: 256 Bytes, Address Range: \$QB24048-\$QB24303									
E/IP Input Instance #111, Qty: 128 Bytes, Address Range: \$IB21488-\$IB21615									
E/IP Input Instance #112, Qty: 256 Bytes, Address Range: \$IB22000-\$IB22335									
NewVar261	DWORD	VAR_GLO...		\$ID22252					
NewVar267	DWORD	VAR_GLO...		\$ID22300					
E/IP Input Instance #113, Qty: 128 Bytes, Address Range: \$IB22512-\$IB22639									
E/IP Input Instance #114, Qty: 256 Bytes, Address Range: \$IB23024-\$IB23279									
E/IP Input Instance #115, Qty: 128 Bytes, Address Range: \$IB23536-\$IB23663									
E/IP Input Instance #116, Qty: 256 Bytes, Address Range: \$IB24048-\$IB24303									

Fig. 2 Global Variables

Step 3. When download Project to device (MP2300Siec), please go to (Fig. 3) Resource->Settings to access setting dialog (Fig. 4) for setting MP2300Siec IP address.

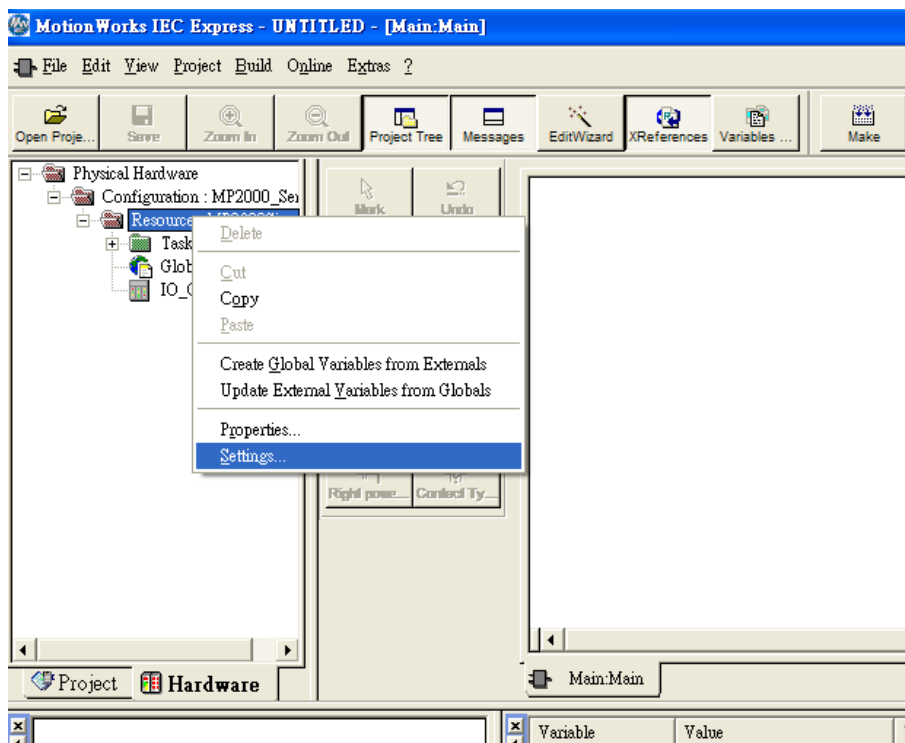


Fig. 3 Motion Works IEC Express – Settings

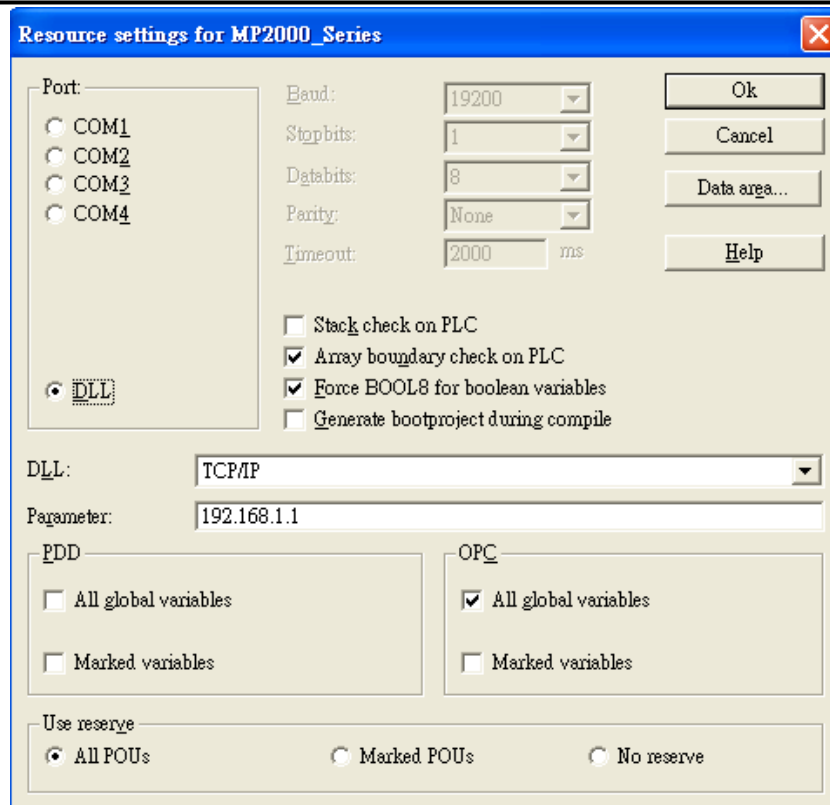


Fig. 4 Resource Settings

Step 4. Start compilation.

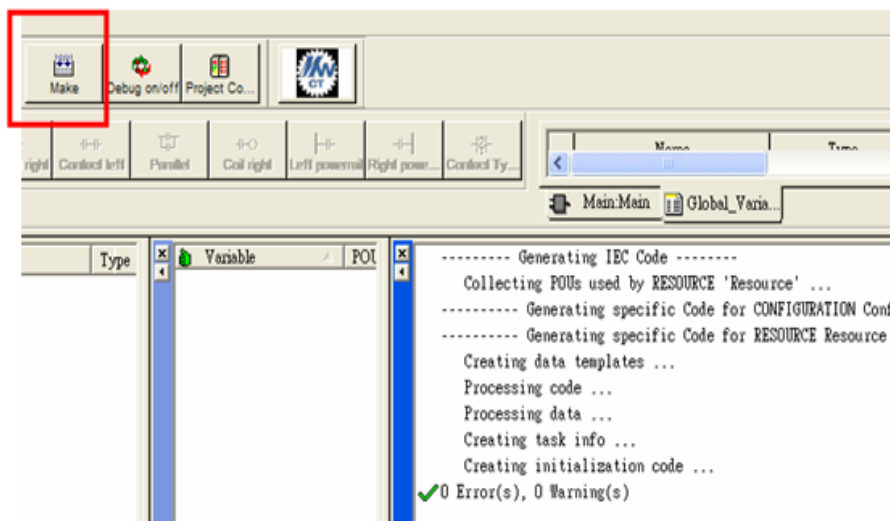


Fig. 5 Editing Screen

Step 5. Download project to device- MP2300Siec, and execute Cold.

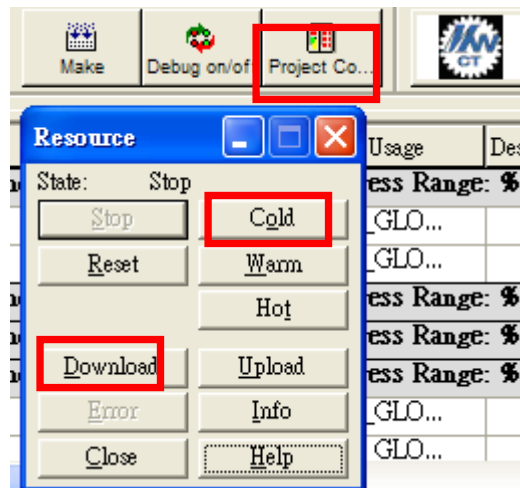


Fig. 6 Project Downloading

You may use one of the two drivers to connect Yaskawa MP2300Siec:

1. Yaskawa MP2300Siec driver.
2. Rockwell EtherNet/IP (CompactLogix) – Free Tag Names driver.

(1) Yaskawa MP2300Siec driver.

Step 1. System Parameter Settings

Open EasyBuilder project, as shown in Fig. 7, Assembly Instance and Size must match the software default factory settings, and please don't select UDP. Fig.8 below shows how HMI Input / Output address is mapped to MP2300Siec device.

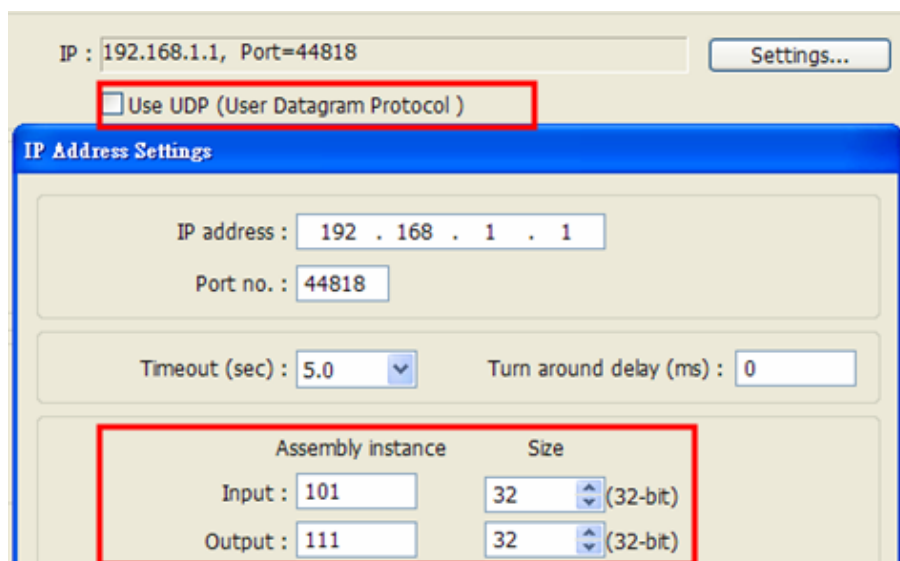


Fig. 7 Instance Setting

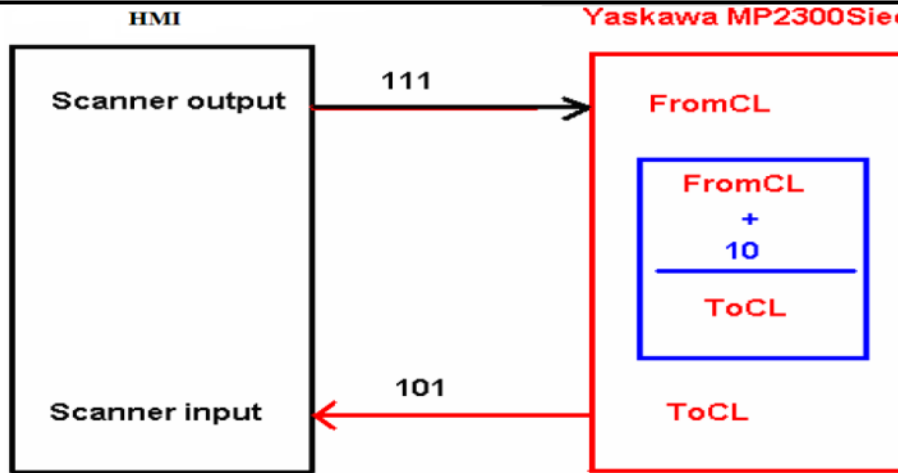


Fig.8 HMI and MP2300Sec I/O Mapping

Step 2. Address Setting:

Instance 101 and Instance 111 are defined as 128Bytes, on the project window , WORD objects can be used, with data typed defined as 32-Bit Unsigned, Input addresses set to 0、2、4、6.....62 for reading Instance 101 data.

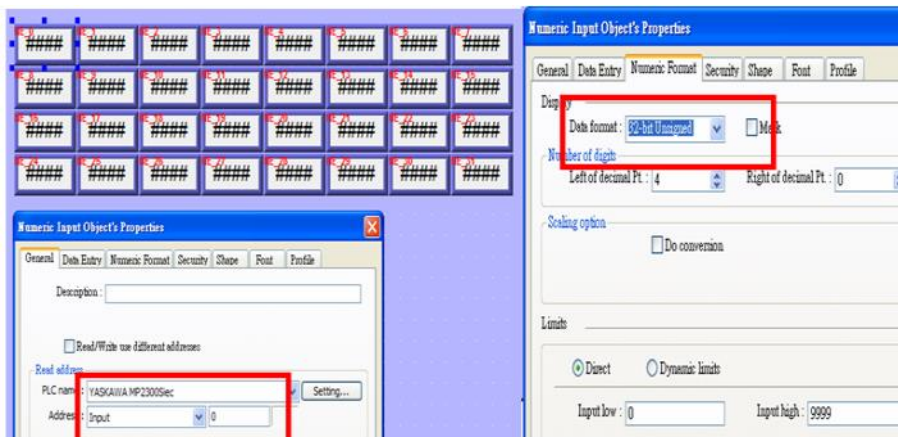


Fig. 9 Address Setting

(2) Rockwell EtherNet/IP (CompactLogix) – Free Tag Names driver.

Step 1. In EasyBuilder8000/EasyBuilder Pro project, when using Rockwell EIP driver to import CSV file (as in Fig. 10), please open Structure Editor (Fig. 11), and right click on Module Defined to add New Data Type.

	A	B	C	D	E	F
1	remark	CSV-Import-Export				
2	remark	Date = Fri Jul 22 15:40:47 2011				
3	remark	Version = RLogix 5000 v18.00				
4	remark	Owner = user				
5	remark	Company = abc				
6	0,3					
7	TYPE	SCOPE	NAME	DESCRIPTION	DATA TYPE	SPECIFIER
8	TAG		MF2300Sec:C		AB:ETHERNET_MODULE:C:0	
9	TAG		MF2300Sec:I		AB:ETHERNET_MODULE_DINT_128Bytes:I:0	
10	TAG		MF2300Sec:O		AB:ETHERNET_MODULE_DINT_128Bytes:O:0	
11	TAG		Local:1:C		AB:Embedded_IQ16F:C:0	
12	TAG		Local:1:I		AB:Embedded_IQ16F:I:0	
13	TAG		Local:2:C		AB:Embedded_OB16:C:0	
14	TAG		Local:2:I		AB:Embedded_OB16:I:0	
15	TAG		Local:2:O		AB:Embedded_OB16:O:0	
16	TAG		Bits		BOOL[32]	
17	TAG		Timer1		TIMER	
18						
19						

Fig. 10 RSLogix 5000 (Rockwell Software) Export Free Tag CSV File

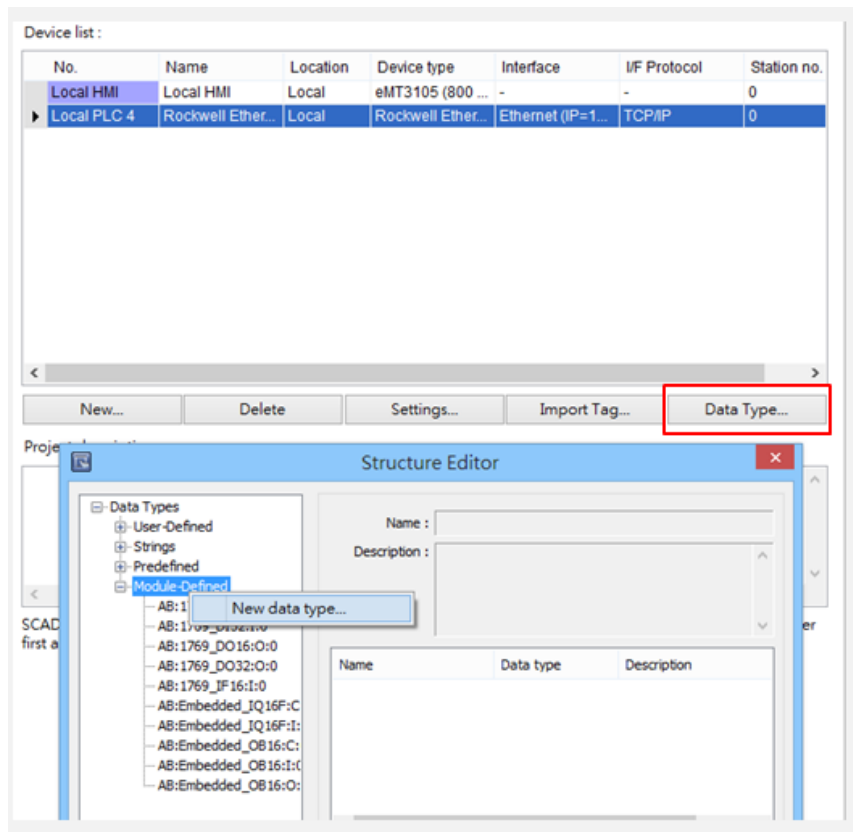


Fig.11 Structure Editor

Step 2. As in Fig 12, in Structure Editor add Name of the new data type. The Name must be set identically to the Data Type in Free Tag CSV file. As in Fig 14, Data Member Name must be set identically to the Rockwell software (as Data in Fig. 13), then click [Save] (Fig. 15).

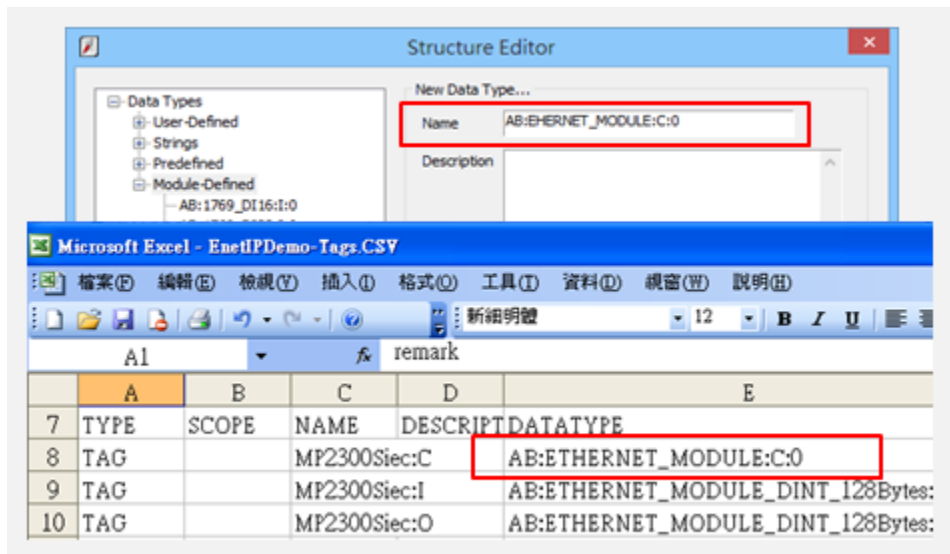


Fig.12 Structure Editor

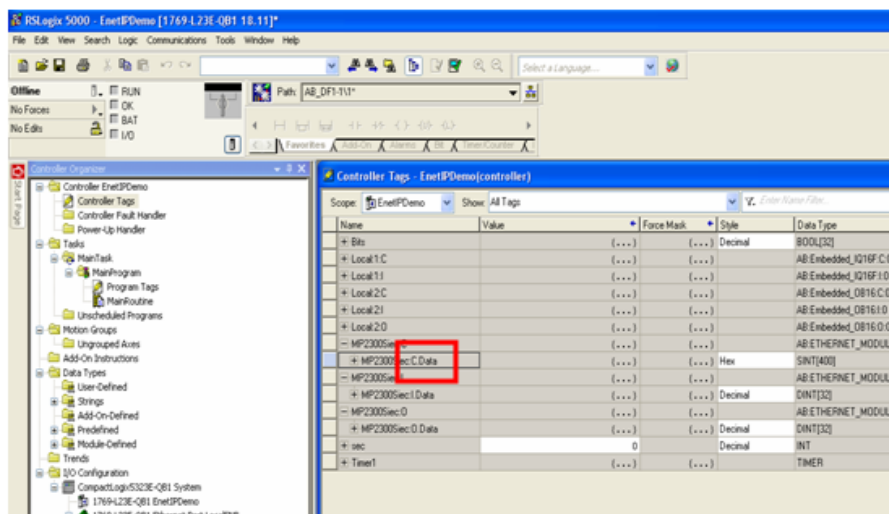


Fig.13 Tag Information

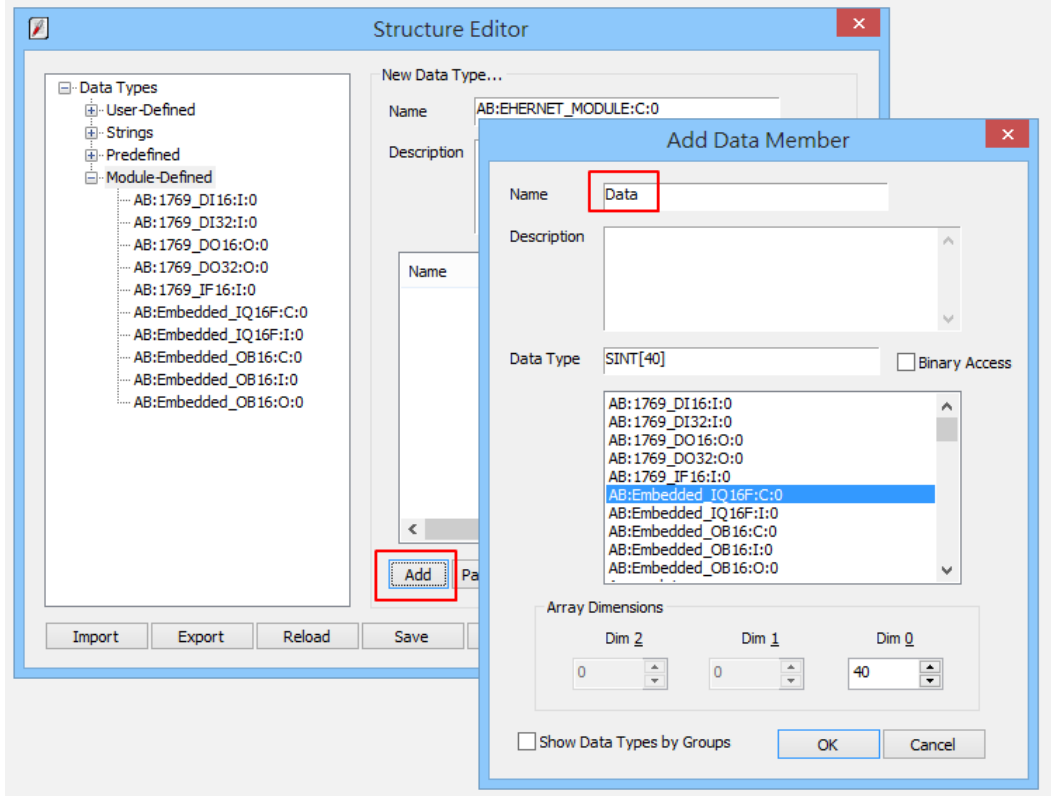


Fig.14 Add Data Member - Name Tag Information

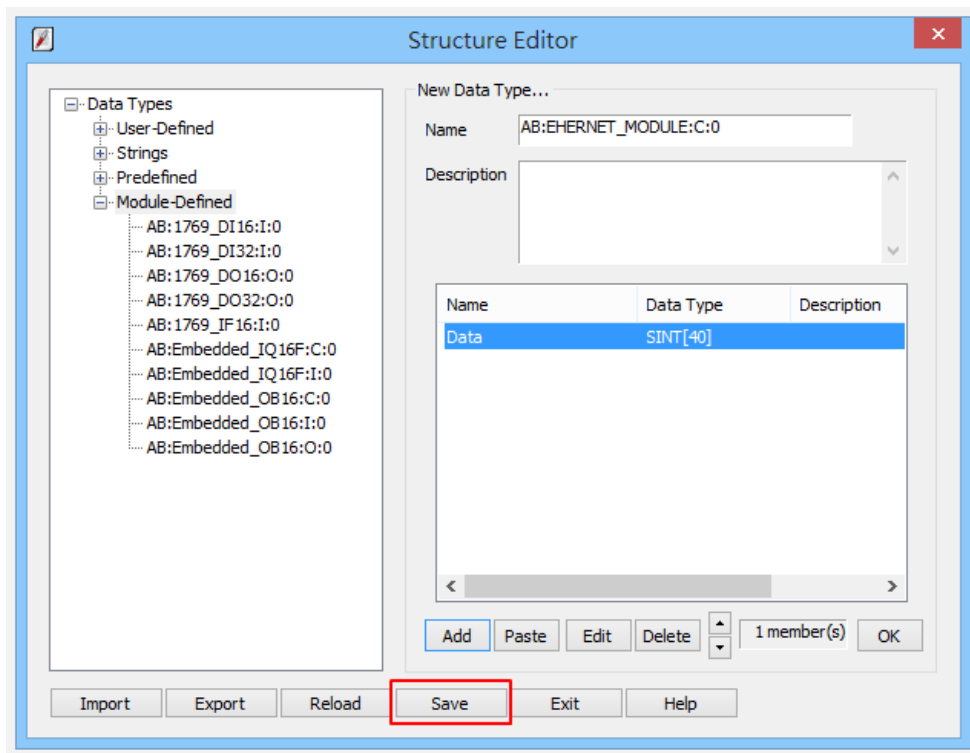


Fig. 15 Add Data Member-Settings - Save

Step 3. Import CSV file, Tag Information can be viewed from object address.

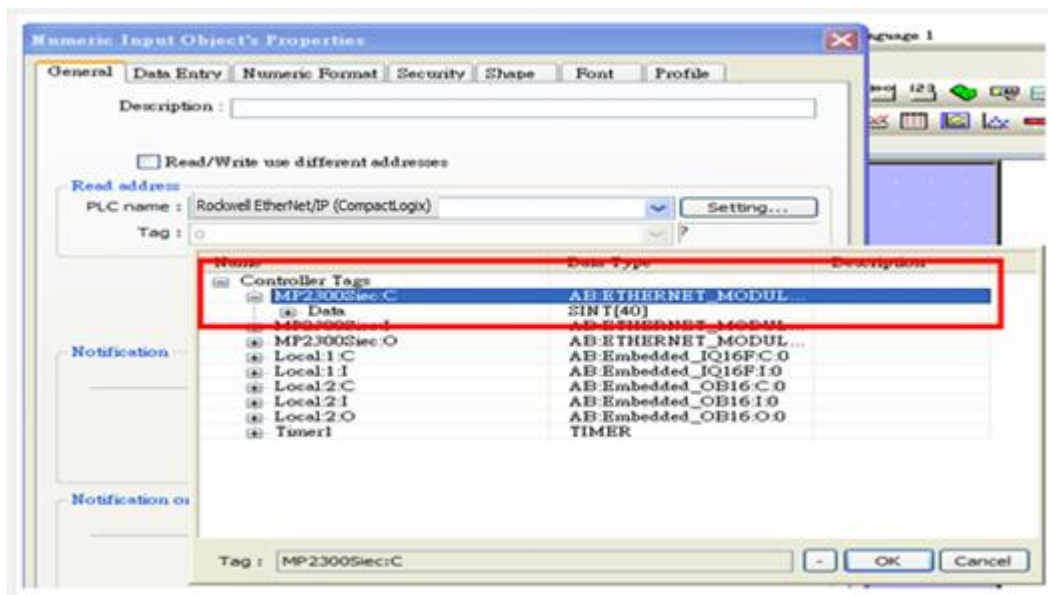


Fig.16 Tag Information

Device Address:

Bit/Word	Device type	Format	Range	Memo
B	Input_Bit	DDDDdd	0 ~ 6553515	
B	Output_Bit	DDDDdd	0 ~ 6553515	
DW	Input	DDDD	0 ~ 65535	
DW	Output	DDDD	0 ~ 65535	

Wiring Diagram:

Ethernet cable

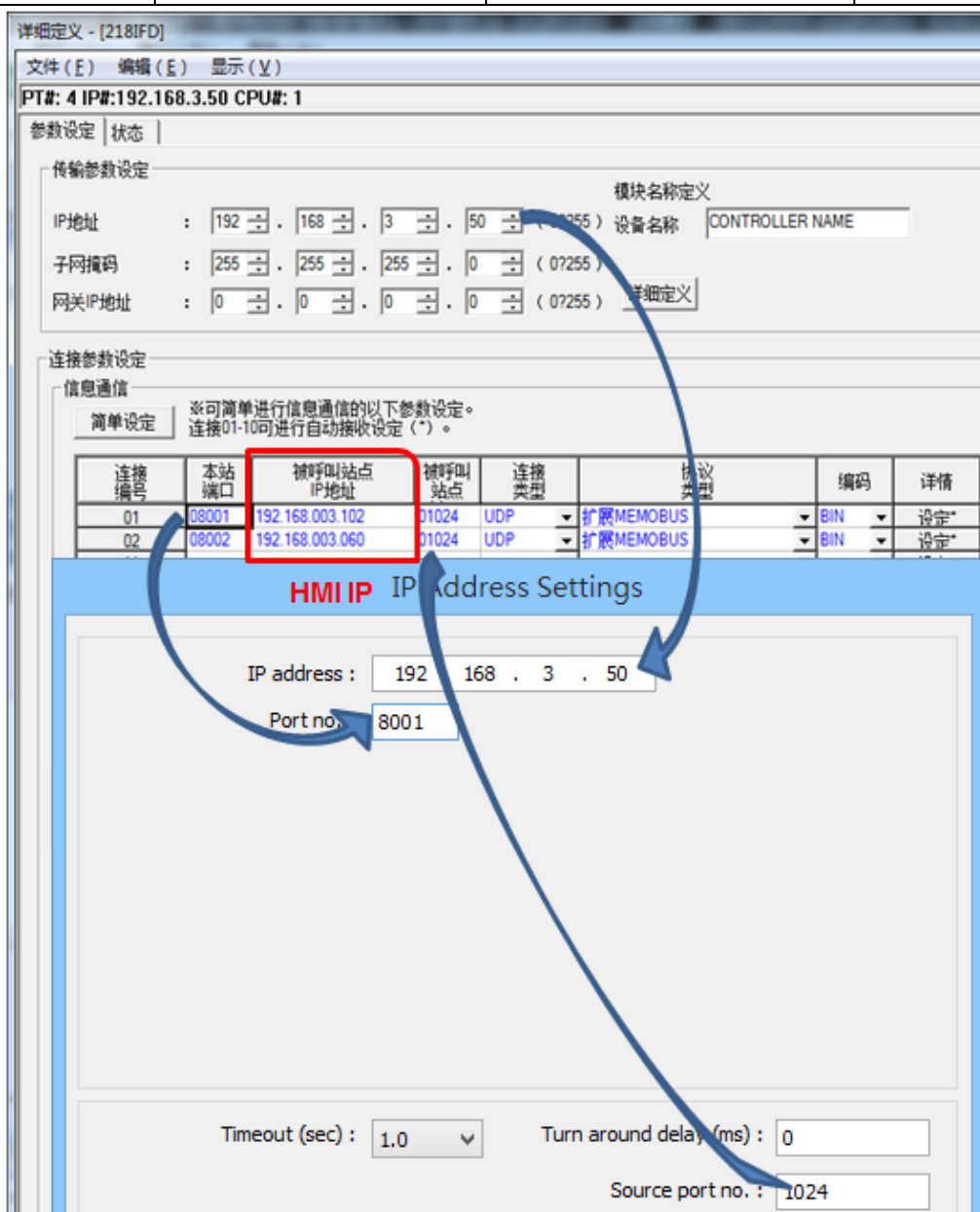


YASKAWA MP3000 Series – Extension (Ethernet)

Website: <http://www.yaskawa.com/site/home.nsf/home/home.html>

HMI Setting:

Parameters	Recommended	Options	Notes
PLC type	YASKAWA MP3000 Series – Extension		
PLC I/F	Ethernet		
Port no.	1024	256 ~ 65535	Local Port
Source Port no.	1024	256 ~ 65535	



详细定义 - [218IFD]

文件 (E) 编辑 (E) 显示 (V)

PT#: 4 IP#:192.168.3.50 CPU#: 1

参数设定 | 状态 |

传输参数设定

IP地址 : 192 . 168 . 3 . 50 (07255) 模块名称定义 设备名称 CONTROLLER NAME

子网掩码 : 255 . 255 . 255 . 0 (07255)

网关IP地址 : 0 . 0 . 0 . 0 (07255) 详细定义

连接参数设定

信息通信

简单设定 ※可简单进行信息通信的以下参数设定。
连接01-10可进行自动接收设定 (*)。

连接编号	本站端口	被呼叫站点 IP地址	被呼叫站点	连接类型	协议类型	编码	详情
01	08001	192.168.003.102	01024	UDP	扩展MEMOBUS	BIN	设定
02	08002	192.168.003.060	01024	UDP	扩展MEMOBUS	BIN	设定

HMI IP Address Settings

IP address : 192 . 168 . 3 . 50

Port no. : 8001

Timeout (sec) : 1.0 Turn around delay (ms) : 0

Source port no. : 1024

Device Address:

Bit/Word	Device type	Format	Range	Memo
B	SB	DDDDDh	0 ~ 65534f	
B	IB	HHHHHh	0 ~ 27fff	
B	OB	HHHHHh	0 ~ 27fff	
B	MB	DDDDDDh	0 ~ 1048575f	
B	GB	DDDDDDh	0 ~ 2097151f	
W	SW	DDDDD	0 ~ 65534	
W	IW	HHHHH	0 ~ 27fff	
W	OW	HHHHH	0 ~ 27fff	
W	MW	DDDDDD	0 ~ 1048575	
W	GW	DDDDDD	0 ~ 2097151	

Wiring Diagram:

Ethernet cable



YASKAWA Sigma-5

Supported Series: YASKAWA Σ -V Series

Website: <http://www.yaskawa.co.jp/>

HMI Setting:

Parameters	Recommended	Options	Notes
PLC type	YASKAWA Sigma-5		
PLC I/F	RS232	RS232/RS485	
Baud rate	19200		
Data bits	8		
Parity	Even		
Stop bits	1		
PLC sta. no.	1	0 ~ 127	

Device Address:

Bit/Word	Device type	Format	Range	Note
B	0_bit	HHHh	0 ~ FFFF	Normal Parameters Area
B	E_bit	HHHh	0 ~ FFFF	Monitor Area
W	0	HHH	0 ~ FFF	Normal Parameters Area
W	E	HHH	0 ~ FFF	Monitor Area

*The following addresses are 32 bit parameters. Please use two words when reading or writing.

- Normal Parameters area
 020AH / 020EH / 0210H / 0212H / 0282H / 051BH / 0520H / 0522H / 0524H / 0526H / 0531H
- Monitor Area
 E003H / E009H / E00EH / E010H / E012H / E016H / E01BH / E084H / E52AH / E52CH / E52EH / E530H / E532H / E534H / E536H / E538H / E53AH / E53CH / E601H / E603H / E605H / E705H / E707H / E110H / E120H / E130H

Display _____

Data format : 32-bit Unsigned ▼ Mask

Number of digits

Left of decimal Pt. : 10 ▲▼ Right of decimal Pt. : 0 ▲▼

Wiring Diagram:

SGDV CN3 RS232 14P (Diagram1~ Diagram3)

Diagram 1

cMT Series	<i>cMT3151</i>
eMT Series	<i>eMT3070 / eMT3105 / eMT3120 / eMT3150</i>
MT-iE	<i>MT8073iE / MT8102iE</i>
MT-XE	<i>MT8092XE</i>
MT-iP	<i>MT6103iP</i>

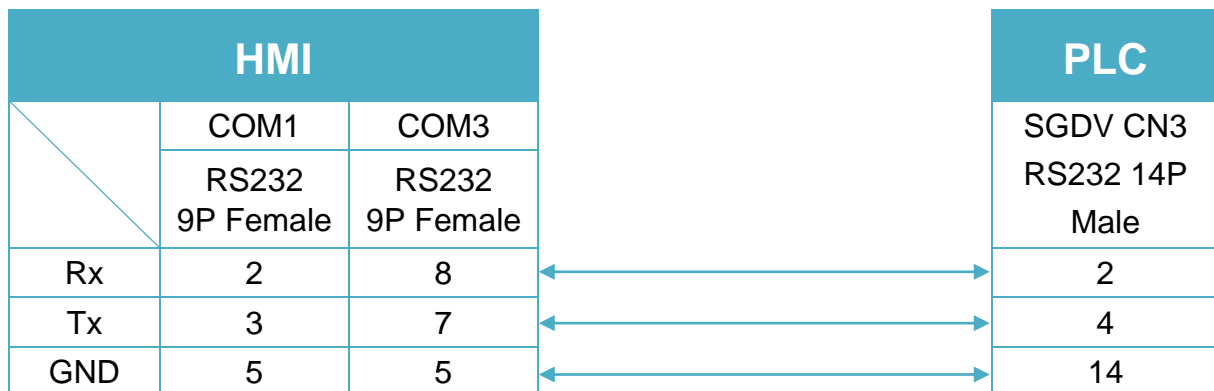


Diagram 2

cMT Series	cMT-SVR
mTV	mTV
MT-iE	MT8070iE / MT6070iE / MT8100iE / MT8121iE / MT8150iE / MT8071iE / MT6071iE / MT8072iE / MT6072iE / MT8073iE / MT8101iE / MT8102iE / MT8103iE
MT-XE	MT8121XE / MT8150XE / MT8090XE

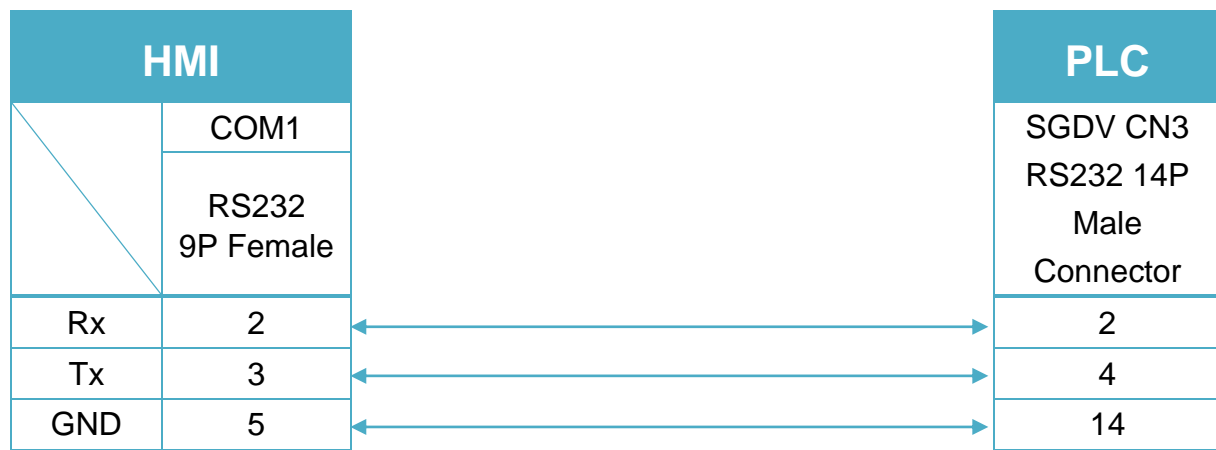
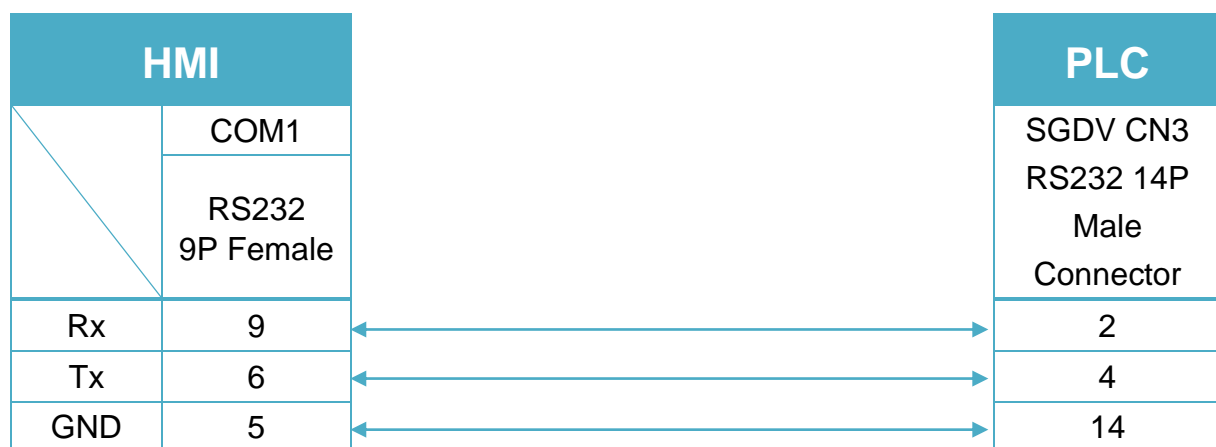


Diagram 3

MT-iE	MT8050iE
MT-iP	MT6051iP / MT6071iP / MT8071iP



YASKAWA SMC 3010

Supported Series: YASKAWA SMC Series Servo Motor Controller.

HMI Setting:

Parameters	Recommended	Options	Notes
PLC type	YASKAWA SMC 3010		
PLC I/F	RS232		
Baud rate	19200	9600, 19200	
Data bits	8		
Parity	None		
Stop bits	1		

Device Address:

Bit/Word	Device type	Format	Range	Memo
B	AF	D	0 ~ 1	
B	BN	D	0 ~ 1	Write only
B	BP	D	0 ~ 1	Write only
B	BV	D	0 ~ 1	Write only
B	CB	DDDD	0 ~ 9999	Write only
B	CM	D	0 ~ 1	Read only
B	DV	D	0 ~ 1	
B	EB	D	0 ~ 1	
B	OE	D	0 ~ 1	
B	RS	D	0 ~ 1	Write only
B	ST	D	0 ~ 1	Write only
B	TB	Do	0 ~ 17	Read only
B	V_Bit	DDDdd	0 ~ 99931	*2
B	D_arr_Bit	DDDdd	0 ~ 99931	
DW	AC	D	0 ~ 4	
DW	DC	D	0 ~ 4	
DW	BL	D	0 ~ 4	
W	CD	D	0 ~ 2	Write only
W	CE	D	0 ~ 2	
DW	DE	D	0 ~ 4	
DW	DP	D	0 ~ 4	

Bit/Word	Device type	Format	Range	Memo
W	DT	D	0 ~ 2	
W	EC	D	0 ~ 2	
DW	EM	D	0 ~ 4	
W	ER	D	0 ~ 2	
W	FA	D	0 ~ 2	
DW	FL	D	0 ~ 4	
W	FV	D	0 ~ 2	
DW	GR	D	0 ~ 4	32 bit float
DW	JG	D	0 ~ 4	
DW	MM	D	0 ~ 4	
W	MT	D	0 ~ 2	
W	NA	D	0 ~ 2	
W	OP	D	0 ~ 2	
DW	PA	D	0 ~ 4	Write only
DW	PR	D	0 ~ 4	
DW	SP	D	0 ~ 4	
W	TC	D	0 ~ 2	Read only
W	TM	D	0 ~ 2	
W	TW	D	0 ~ 2	
DW	VA	D	0 ~ 4	
DW	VD	D	0 ~ 4	
DW	VS	D	0 ~ 4	
DW	IL	D	0 ~ 4	32 bit float
DW	IT	D	0 ~ 4	32 bit float
DW	KD	D	0 ~ 4	32 bit float
DW	KI	D	0 ~ 4	32 bit float
DW	KP	D	0 ~ 4	32 bit float
DW	OF	D	0 ~ 4	32 bit float
DW	TL	D	0 ~ 4	32 bit float
DW	VR	D	0 ~ 4	32 bit float
DW	VT	D	0 ~ 4	32 bit float
DW	PF	D	0 ~ 4	32 bit float *1
DW	VF	D	0 ~ 4	32 bit float
DW	V	DDD	0 ~ 999	*2
DW	F	DDD	0 ~ 999	32 bit float *2
W	D_array	DDD	0 ~ 999	
DW	R_array	DDD	0 ~ 999	32 bit float

Note:

*1 PF is the communication parameter of SMC_3010, the default is 10.4, if the value is not 10.4, all values will be displayed incorrectly.

*2 User defined integer variable V000~V999, floating point variable F000~F999.

Wiring Diagram:

RS-232 9P D-Sub (Diagram 1 ~ Diagram3)

Diagram 1

cMT Series	<i>cMT3151</i>
eMT Series	<i>eMT3070 / eMT3105 / eMT3120 / eMT3150</i>
MT-iE	<i>MT8073iE / MT8102iE</i>
MT-XE	<i>MT8092XE</i>
MT-iP	<i>MT6103iP</i>

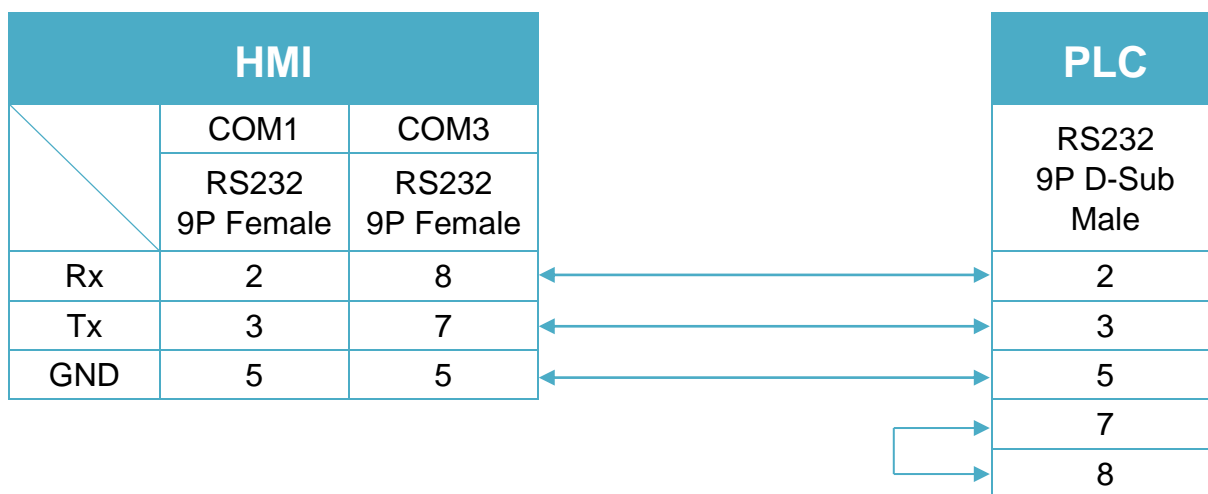


Diagram 2

cMT Series	cMT-SVR
mTV	mTV
MT-iE	MT8070iE / MT6070iE / MT8100iE / MT8121iE / MT8150iE / MT8071iE / MT6071iE / MT8072iE / MT6072iE / MT8073iE / MT8101iE / MT8102iE / MT8103iE
MT-XE	MT8121XE / MT8150XE / MT8090XE

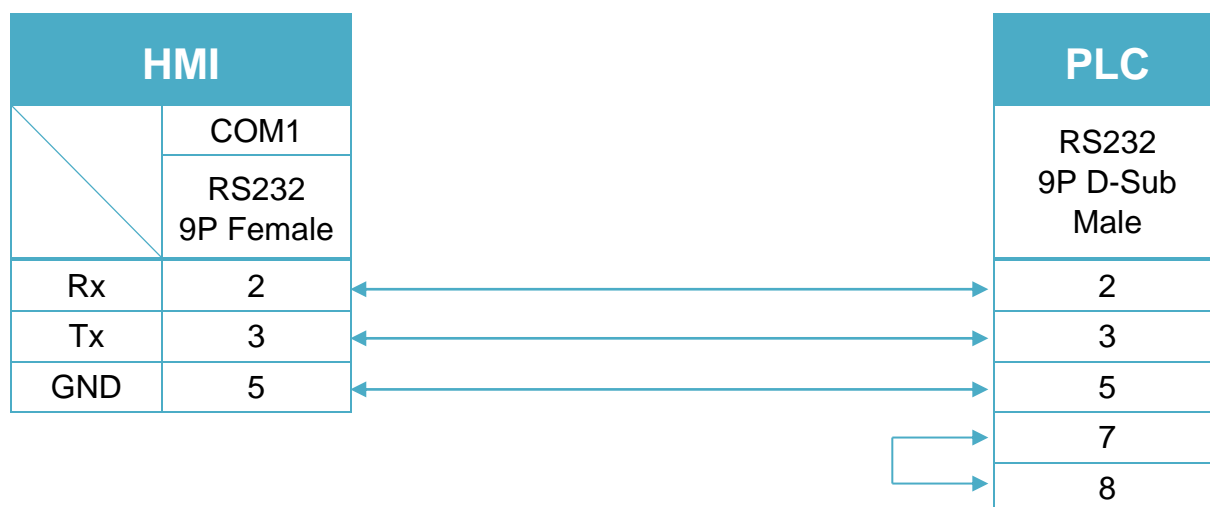
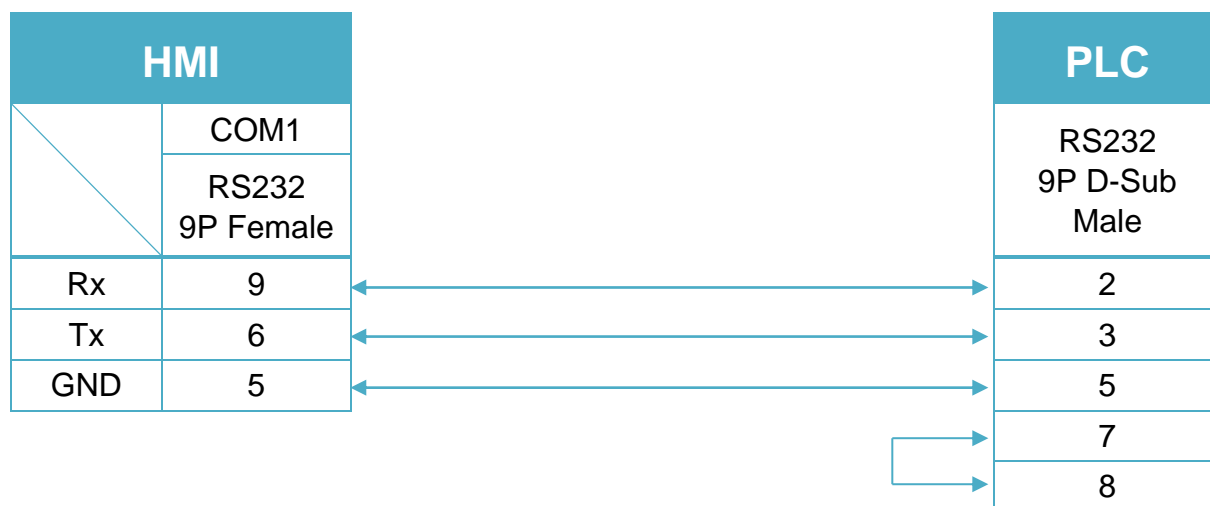


Diagram 3

MT-iE	MT8050iE
MT-iP	MT6051iP / MT6071iP / MT8071iP



YASKAWA SMC 3010 (Ethernet)

Supported Series: YASKAWA SMC Series Servo Motor Controller.

HMI Setting:

Parameters	Recommended	Options	Notes
PLC type	YASKAWA SMC 3010 (Ethernet)		
PLC I/F	Ethernet		
Port no.	23		

Device Address:

Bit/Word	Device type	Format	Range	Memo
B	AF	D	0 ~ 7	
B	BN	D	0	Write only
B	BP	D	0	Write only
B	BV	D	0	Write only
B	CB	DDDD	0 ~ 9999	Write only
B	CM	D	0 ~ 0	Read only
B	DV	D	0 ~ 7	
B	EB	D	0	
B	OE	D	0 ~ 7	
B	RS	D	0	Write only
B	ST	D	0	Write only
B	TB	Do	0 ~ 07	Read only
B	V_Bit	DDDdd	0 ~ 99931	*2
B	D_arr_Bit	DDDdd	0 ~ 99931	
DW	AC	D	0 ~ 7	
DW	DC	D	0 ~ 7	
DW	BL	D	0 ~ 7	
W	CD	D	0 ~ 7	Write only
W	CE	D	0 ~ 7	
DW	DE	D	0 ~ 7	
DW	DP	D	0 ~ 7	
W	DT	D	0	
W	EC	D	0	
DW	EM	D	0 ~ 7	

Bit/Word	Device type	Format	Range	Memo
W	ER	D	0 ~ 7	
W	FA	D	0 ~ 7	
DW	FL	D	0 ~ 7	
W	FV	D	0 ~ 7	
DW	GR	D	0	32 bit float
DW	JG	D	0 ~ 7	
DW	MM	D	0	
W	MT	D	0 ~ 7	
W	NA	D	0	
W	OP	D	0	
DW	PA	D	0 ~ 7	Write only
DW	PR	D	0 ~ 7	
DW	SP	D	0 ~ 7	
W	TC	D	0	Read only
W	TM	D	0	
W	TW	D	0 ~ 7	
DW	VA	D	0	
DW	VD	D	0	
DW	VS	D	0	
DW	IL	D	0 ~ 7	32 bit float
DW	IT	D	0 ~ 7	32 bit float
DW	KD	D	0 ~ 7	32 bit float
DW	KI	D	0 ~ 7	32 bit float
DW	KP	D	0 ~ 7	32 bit float
DW	OF	D	0 ~ 7	32 bit float
DW	TL	D	0 ~ 7	32 bit float
DW	VR	D	0	32 bit float
DW	VT	D	0	32 bit float
DW	PF	D	0	32 bit float *1
DW	VF	D	0	32 bit float
DW	V	DDD	0 ~ 999	*2
W	F	DDD	0 ~ 999	32 bit float *2
W	D_array	DDD	0 ~ 999	
DW	R_array	DDD	0 ~ 999	32 bit float

Note:

*1 PF is the communication parameter of SMC_3010, the default is 10.4, if the value is not 10.4, all values will be displayed incorrectly.

*2 User defined integer variable V000~V999, floating point variable F000~F999.

Wiring Diagram:

Ethernet cable



YOKOGAWA FA-M3

Supported Series : FA-M3 CPU SP35-5N, SP55-5N CPU port, F3LC11 Computer Link module.

Website : <http://www.yokogawa.com/itc/itc-index-en.htm>

HMI Setting:

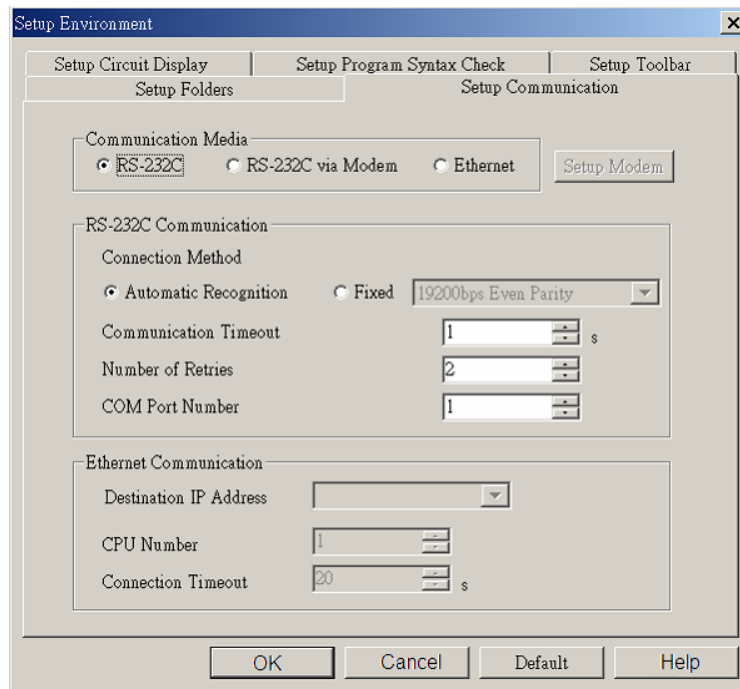
Parameters	Recommended	Options	Notes
PLC type	YOKOGAWA FA-M3		
PLC I/F	RS232		
Baud rate	19200	9600 ~ 115200	
Data bits	8	7, 8	
Parity	Even	Even, Odd, None	
Stop bits	1	1, 2	
PLC sta. no.	1	1-32	

PLC Setting:

Communication mode	Use Personal Communication Link Use checksum Use End Character
---------------------------	---

WideField communication setting:

For WideField communication setting, select [Tool]/ [Set Environment], the default is [Automatic]. Using the Automatic Recognition, WideField software will connect the current PLC and get the PLC communication setting. If the PLC communication configuration is already known, select the [Fixed] mode, It will connect with the PLC quickly.



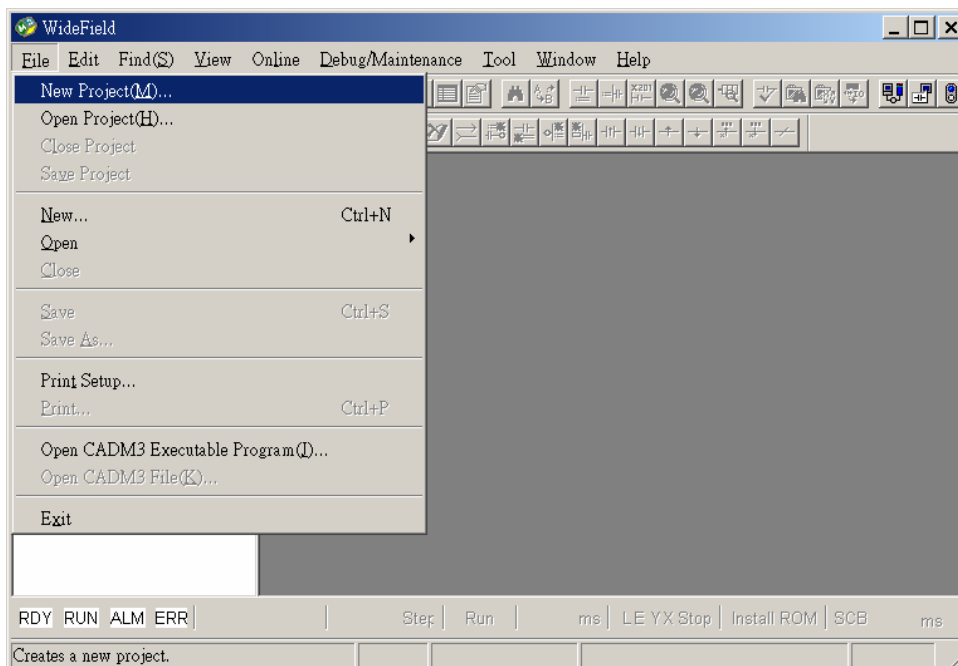
P.S Since Personal Computer link is used, when connecting to PLC it will delay about 20sec for testing communication.

YOKOGAWA PLC Communication Setting:

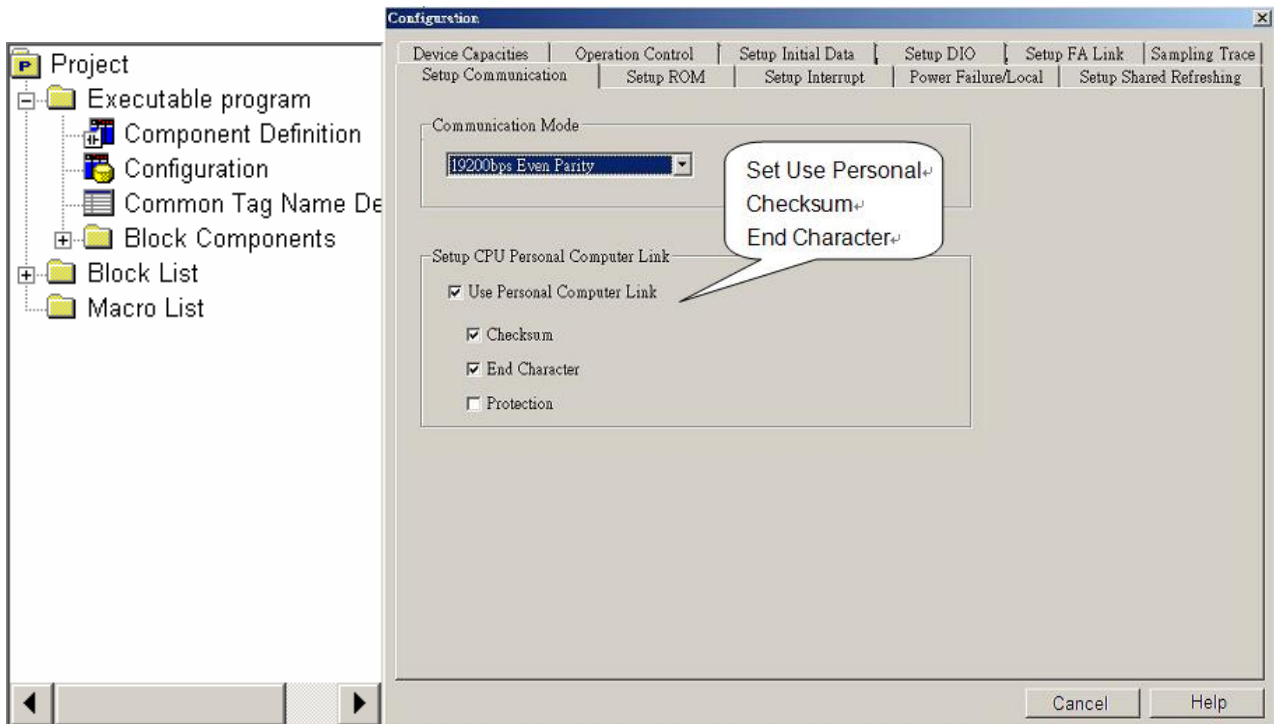
YOKOGAWA FA-M3

CPU SP55-5N (same SP35-5N)

[File] / [New Project] to create a new project.



Click [Configuration] to set up communication.



Device Address:

Bit/Word	Device	Format	Range	Memo
B	X	DDDDD	0 ~ 71664	
B	Y	DDDDD	0 ~ 71664	
B	I	DDDDD	1 ~ 65535	
B	M	DDDD	1 ~ 9984	
B	L	DDDDD	0 ~ 78192	
W	D	DDDDD	1 ~ 65535	
W	B	DDDDDD	1 ~ 262144	
W	V	DDD	1 ~ 256	
W	W	DDDDD	1 ~ 78192	
W	Z	DDDD	1 ~ 1024	
W	F	DDDDDD	1 ~ 524288	

Wiring Diagram:

RS-232 9P D-Sub (Diagram 1 ~ Diagram3)

Diagram 1

cMT Series	<i>cMT3151</i>
eMT Series	<i>eMT3070 / eMT3105 / eMT3120 / eMT3150</i>
MT-iE	<i>MT8073iE / MT8102iE</i>
MT-XE	<i>MT8092XE</i>
MT-iP	<i>MT6103iP</i>

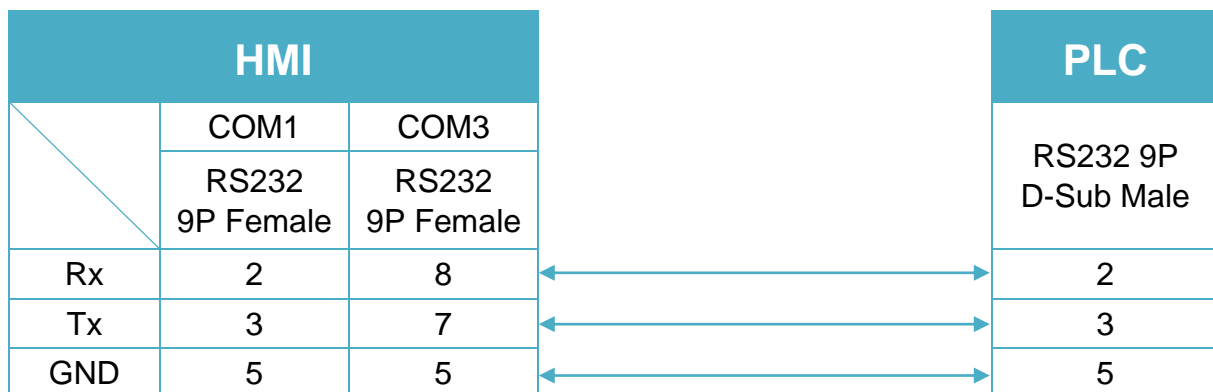


Diagram 2

cMT Series	cMT-SVR
mTV	mTV
MT-iE	MT8070iE / MT6070iE / MT8100iE / MT8121iE / MT8150iE / MT8071iE / MT6071iE / MT8072iE / MT6072iE / MT8073iE / MT8101iE / MT8102iE / MT8103iE
MT-XE	MT8121XE / MT8150XE / MT8090XE

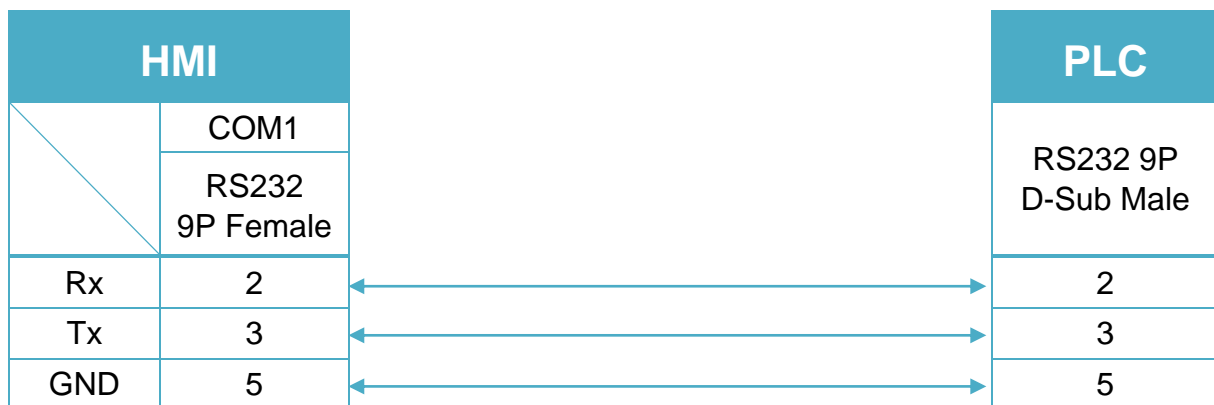
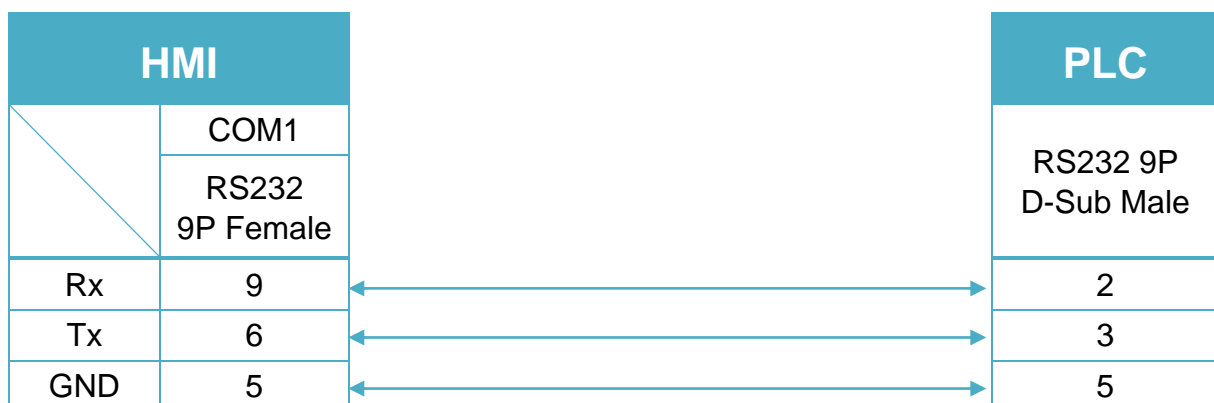


Diagram 3

MT-iE	MT8050iE
MT-iP	MT6051iP / MT6071iP / MT8071iP



RS-232 9P D-Sub (Diagram 4 ~ Diagram6)

Diagram 4

cMT Series	<i>cMT3151</i>
eMT Series	<i>eMT3070 / eMT3105 / eMT3120 / eMT3150</i>
MT-iE	<i>MT8073iE / MT8102iE</i>
MT-XE	<i>MT8092XE</i>
MT-iP	<i>MT6103iP</i>

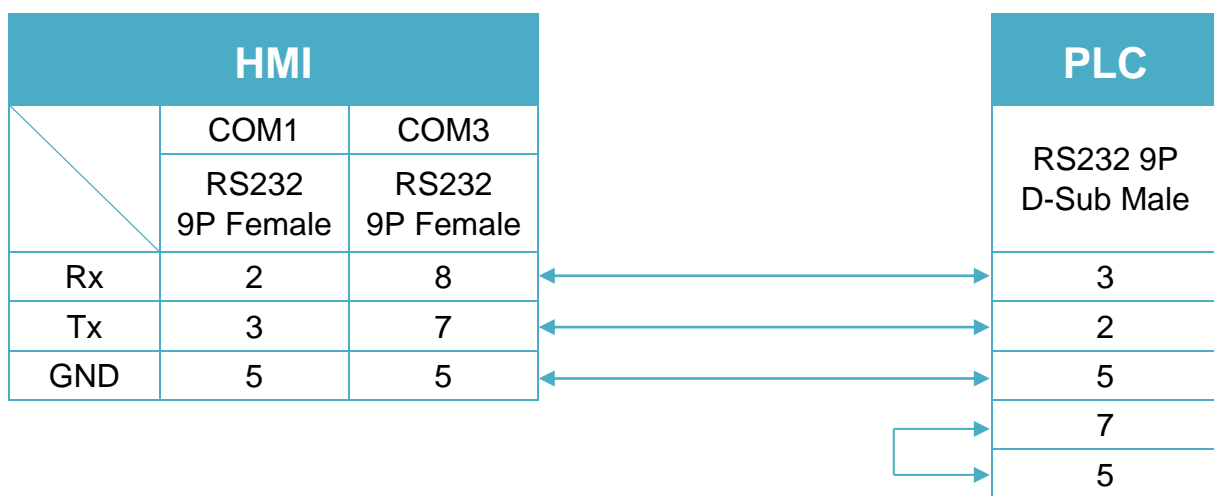


Diagram 5

cMT Series	cMT-SVR
mTV	mTV
MT-iE	MT8070iE / MT6070iE / MT8100iE / MT8121iE / MT8150iE / MT8071iE / MT6071iE / MT8072iE / MT6072iE / MT8073iE / MT8101iE / MT8102iE / MT8103iE
MT-XE	MT8121XE / MT8150XE / MT8090XE

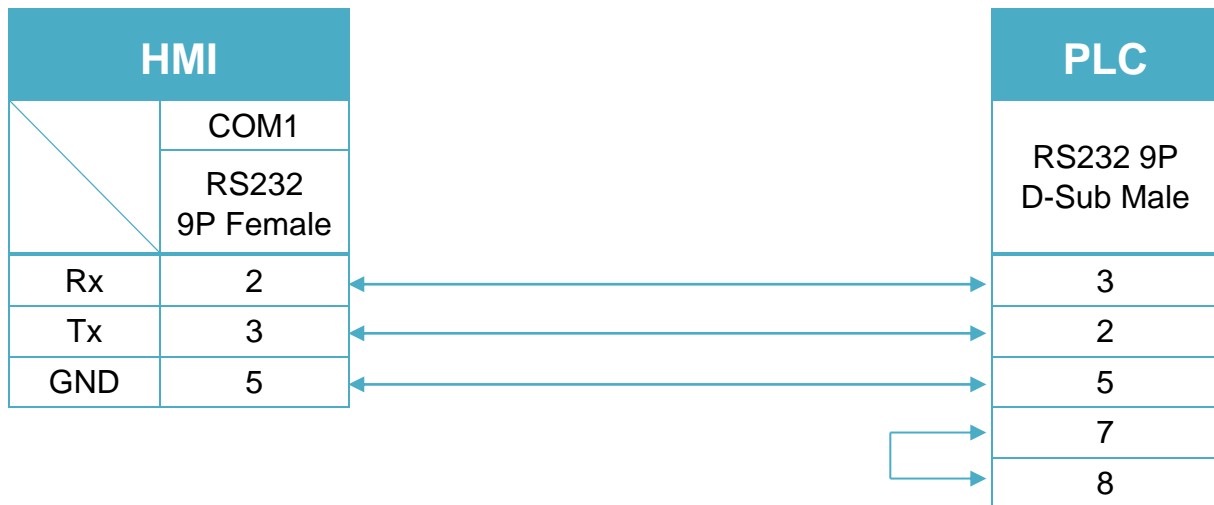
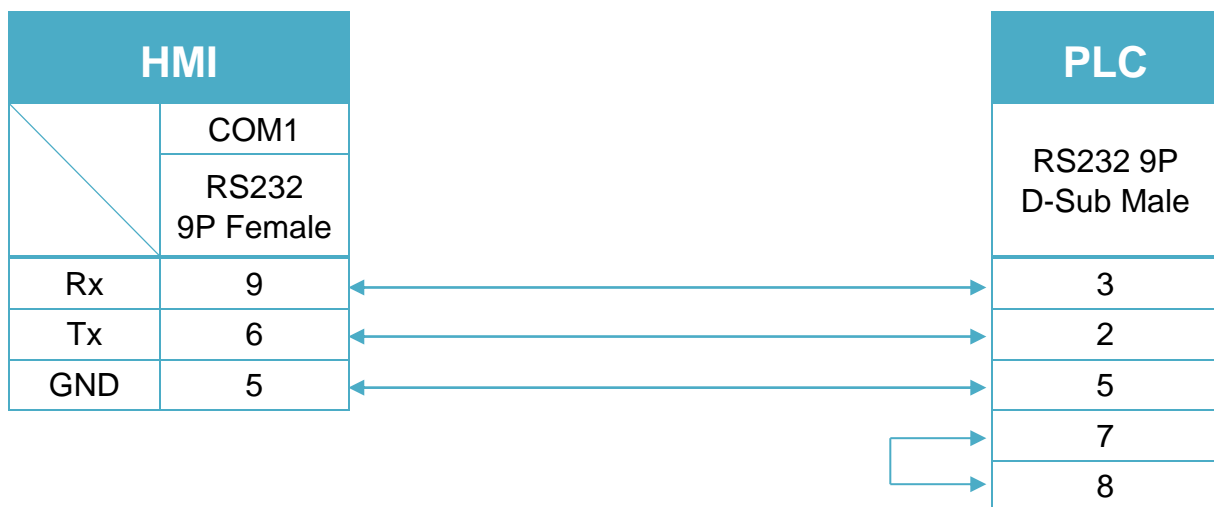


Diagram 6

MT-iE	MT8050iE
MT-iP	MT6051iP / MT6071iP / MT8071iP



YOKOGAWA FA-M3 (Ethernet)

Supported Series : FA-M3 CPU SP35-5N, SP55-5N with F3LE01-5T/F3LE11-0T Ethernet module.

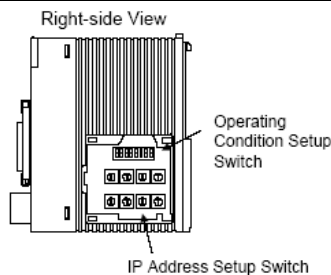
Website: <http://www.yokogawa.com/itc/itc-index-en.htm>

HMI Setting:

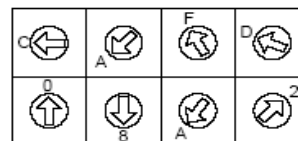
Parameters	Recommended	Options	Notes
PLC type	YOKOGAWA FA-M3 (Ethernet)		
PLC I/F	Ethernet		
Port no.	12289		
PLC sta. no.	1		

PLC Setting:

Communication mode	Set IP Address, and set all condition setup switch to OFF.
---------------------------	--



Example: Setting the IP address to 192.168.250.210



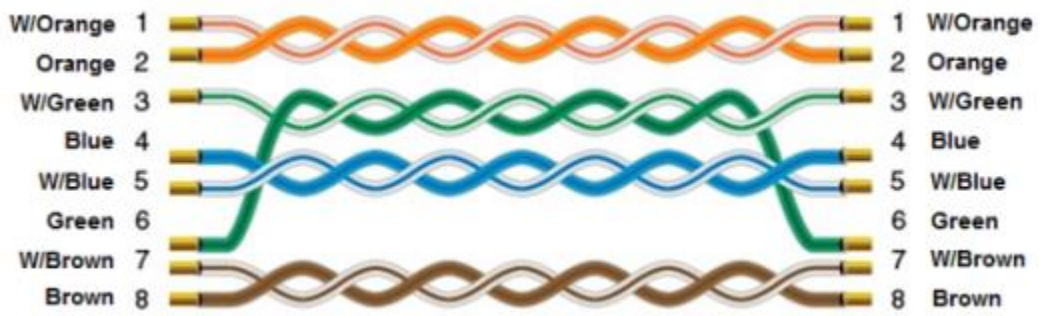
Hexa	C0	A8	FA	D2
decimal	↑	↑	↑	↑
Decimal	192	168	250	210

Device Address:

Bit/Word	Device type	Format	Range	Memo
B	X	DDDDD	0 ~ 71664	
B	Y	DDDDD	0 ~ 71664	
B	I	DDDDD	1 ~ 65535	
B	M	DDDD	1 ~ 9984	
B	L	DDDDD	0 ~ 78192	
W	D	DDDDD	1 ~ 65535	
W	B	DDDDDD	1 ~ 262144	
W	V	DD	1 ~ 256	
	W	DDDDD	1 ~ 78192	
W	Z	DDDD	1 ~ 1024	
W	F	DDDDDD	1 ~ 524288	

Wiring Diagram:

Ethernet cable



YUDIAN AIBUS

Supported Series: YUDIAN Automation AI-501, AI-518, AI-519, AI-701, AI-702M, AI-704M, AI-706M, AI-719.

Website: <http://www.yudian.us>

HMI Setting:

Parameters	Recommended	Options	Notes
PLC type	AIBUS		
PLC I/F	RS485 2W	RS232	
Baud rate	9600	9600, 19200	
Data bits	8		
Parity	None		
Stop bits	2		
HMI sta. no.	0		
PLC sta. no.	1	0-100	

On-line simulation	YES
Extend address mode	NO

Device Address:

AI-518

Bit/Word	Device type		Format	Range	Memo
W	0	00H	DD		SV/STEP
W	1	01H	DD	-1999 ~ 9999	HIAL
W	2	02H	DD	-1999 ~ 9999	LoAL
W	3	03H	DD	0 ~ 9999	dHAL
W	4	04H	DD	0 ~ 9999	dLAL
W	5	05H	DD	0 ~ 2000	dF
W	6	06H	DD	0 ~ 4	Ctrl
W	7	07H	DD	0 ~ 9999	M5
W	8	08H	DD	1 ~ 9999	P
W	9	09H	DD	0 ~ 2000	t
W	10	0AH	DD	0 ~ 125	Ctl

Bit/Word	Device type		Format	Range	Memo
W	11	0BH	DD	0 ~ 37	Sn (read only)
W	12	0CH	DD	0 ~ 3	dIP (read only)
W	13	0DH	DD	-1999 ~ 9999	dIL
W	14	0EH	DD	-1999 ~ 9999	dIH
W	15	0FH	DD	0 ~ 9999	ALP
W	16	10H	DD	-1999 ~ 4000	Sc
W	17	11H	DD	0 ~ 48	Op1
W	18	12H	DD	-110 ~ 110%	oPL
W	19	13H	DD	0 ~ 110%	oPH
W	20	14H	DD	0 ~ 127	CF (read only)
W	21	15H	DD	0 ~ 19.2K	Baud rate (bAud)
W	22	16H	DD	0 ~ 100	ADDR
W	23	17H	DD	0 ~ 20	dL
W	24	18H	DD	0 ~ 127	Run
W	25	19H	DD	0 ~ 9999	Loc

AI-701

Bit/Word	Device type		Format	Range	Memo
W	1	01H	DD	-9990 ~ 30000	HIAL
W	2	02H	DD	-9990 ~ 30000	LoAL
W	3	03H	DD	-9990 ~ 30000	HdAL
W	4	04H	DD	-9990 ~ 30000	LdAL
W	5	05H	DD	0 ~ 2000	AHYS
W	11	0BH	DD	0 ~ 37	InP (read only)
W	12	0CH	DD	0 ~ 3	dPt
W	13	0DH	DD	-9999 ~ 30000	SCL
W	14	0EH	DD	-9999 ~ 30000	SCH
W	15	0FH	DD	0 ~ 4444	AOP
W	16	10H	DD	-1999 ~ 4000 0.1°C	Scb
W	17	11H	DD	0 ~ 48	Opt
W	21	15H	DD	0 ~ 19.2K	Baud rate (bAud) /808P status word run: 0 suspend: 4 stop: 12 (read only)
W	22	16H	DD	0 ~ 80	ADDR

Bit/Word	Device type		Format	Range	Memo
W	23	17H	DD	0 ~ 40	FILt
W	25	19H	DD	0 ~ 255	Loc

Wiring Diagram:

RS-485 2W Terminal (Diagram 1 ~ Diagram6)

Diagram 1

cMT Series

cMT3151

eMT Series

eMT3070 / eMT3105 / eMT3120 / eMT3150

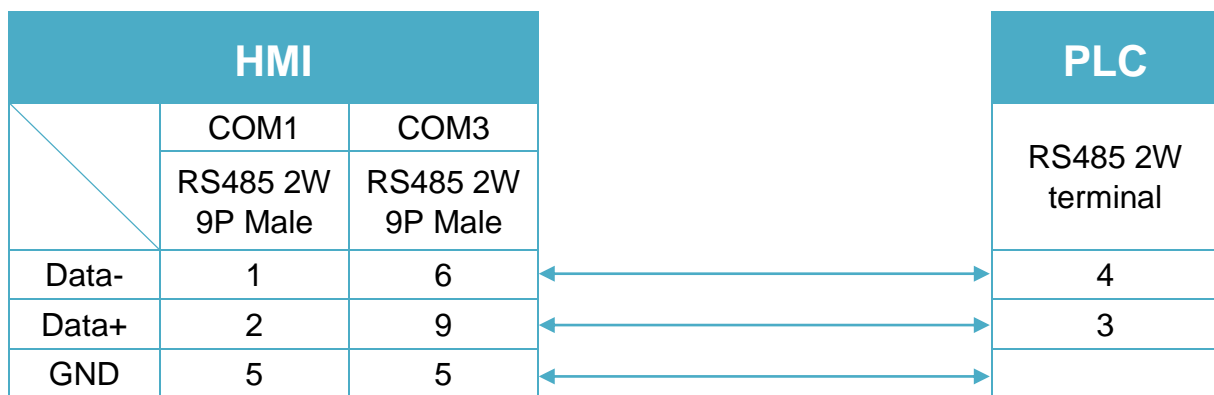


Diagram 2

cMT Series

cMT-SVR

mTV

mTV

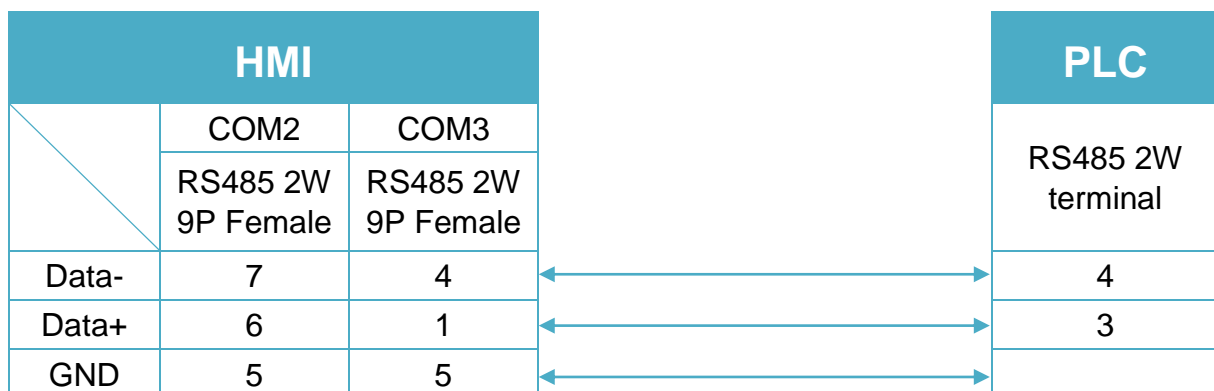


Diagram 3

MT-iE *MT8070iE / MT6070iE / MT8100iE / MT8121iE / MT8150iE*

MT-XE *MT8121XE / MT8150XE*

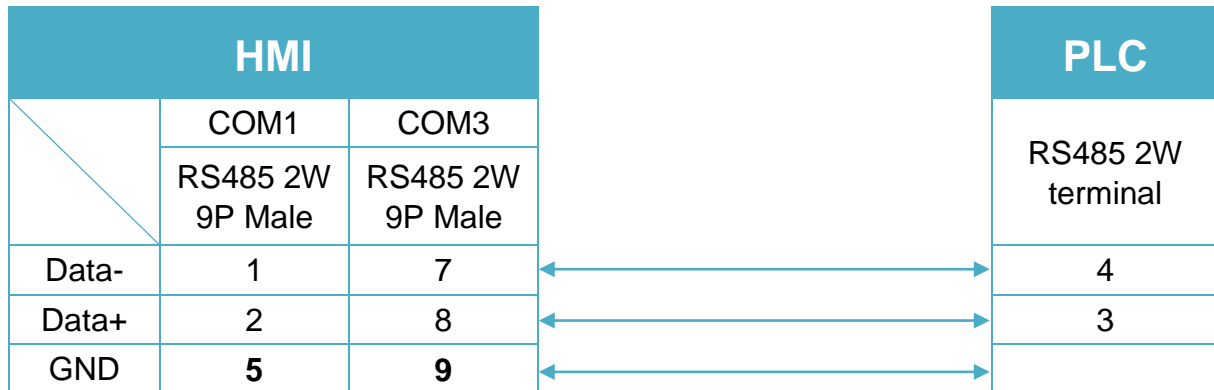


Diagram 4

MT-iE *MT8071iE / MT6071iE / MT8072iE / MT6072iE / MT8073iE /
MT8101iE / MT8102iE / MT8103iE*

MT-XE *MT8090XE / MT8092XE*

MT-iP *MT6103iP*

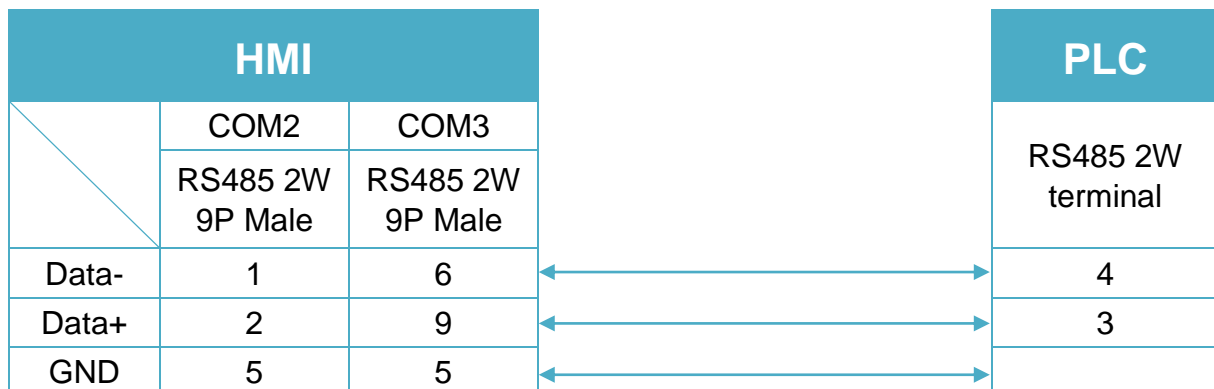


Diagram 5

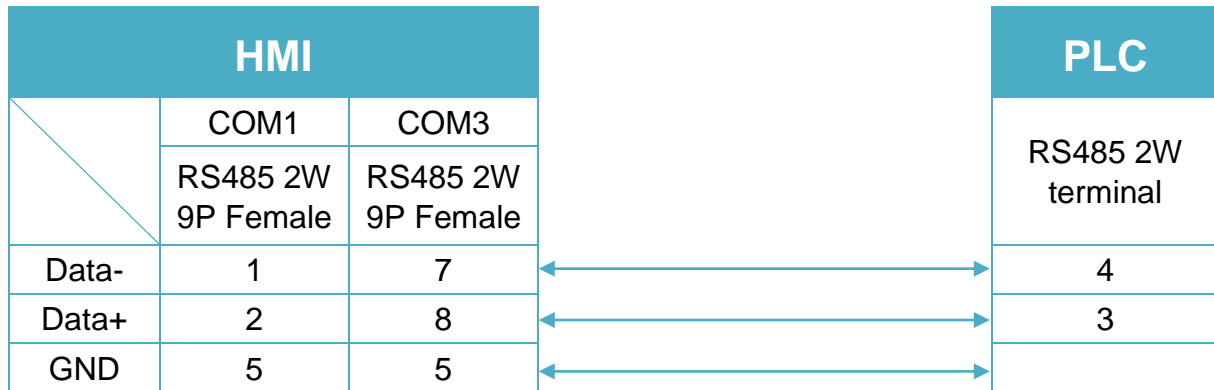
MT-iE *MT8050iE*
MT-iP *MT6051iP*


Diagram 6

MT-iP *MT6071iP / MT8071iP*
